

FPC/FFC Connectors

OMRON

XF Series



Connect to your future applications



XF3C



XF3A

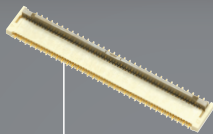

XF3B



XF2B



XF3Z

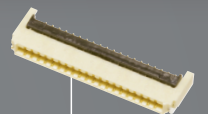

XF2U

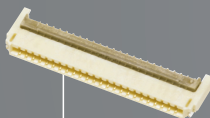

XF2W

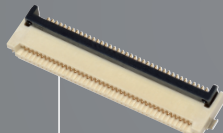

XF3M

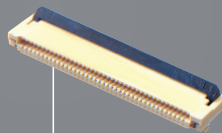

XF2M









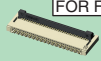

XF2L

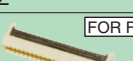
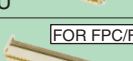
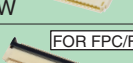

XF2J

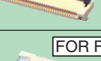
INDEX

Model	Lock mechanism	Pitch	On-board height	Depth (*1)	Applicable FPC/ FFC thickness	Contact type	Page
 FOR FPC XF3C	Rotary backlock	0.25 mm	0.85 mm	3.8 mm	0.12 mm	Dual sided	P5
 FOR FPC XF3A	Rotary backlock	0.3 mm	0.6 mm	3.8 mm	0.12 mm	Upper sided	P6
 FOR FPC XF3B	Rotary backlock	0.3 mm	0.9 mm	4.0 mm *2	0.2 mm	Dual sided	P7
 FOR FPC XF2B	Rotary backlock	0.3 mm	1.2 mm	5.5 mm	0.2 mm	Dual sided *3	P8
 FOR FPC XF3Z	Rotary frontlock	0.3 mm	1.0 mm	3.5 mm	0.2 mm	Lower sided	P9
 FOR FPC XF2U	Rotary backlock	0.5 mm	0.9 mm	3.5 mm	0.2 mm	Dual sided	P10
 FOR FPC/FFC XF2W	Rotary backlock	0.5 mm	1.1 mm	3.5 mm *4	0.3 mm	Dual sided	P11
 FOR FPC/FFC XF3M	Rotary backlock	0.5 mm	2.0 mm	6.4 mm *5	0.3 mm	Dual sided/ upper sided	P13
		1.0 mm					P15
 FOR FPC/FFC XF2M	Rotary backlock	0.5 mm	2.0 mm *6	5.9 mm *7	0.3 mm	Dual sided	P16
 FOR FPC XF2L	Slide lock	0.5 mm	1.2 mm	3.45 mm	0.3 mm	Upper sided/ Lower sided	P17
 FOR FPC/FFC XF2J	Slide lock	0.5 mm	4.15 mm *8	3.45 mm	0.3 mm	Single-sided contact	P18

*1: These are latch closed dimension.

*2: XF3B-□□45-31AE is 4.5 mm

*3: XF2B-6155-31A is upper sided.

*4: XF2W-□□15-1AE-□ is 4.1 mm

*5: XF3M-□□15-1BE-□ is 6.7 mm

*6: XF2M-□□15-1AH-□ is 2.1 mm

*7: XF2M-□□15-1AH-□ is 6.2 mm

*8: XF2J-4024-12A-□ is 4.25 mm

Model Number Legend

* Use this legend when determining the product specifications from the model number. Choose from the model numbers listed in this catalog when ordering.

XF□□-□□□□-□□□□-□
 (1) (2) (3) (4) (5) (6) (7) (8) (9)

(1) Classification in Series

2B, 2J, 2L, 2M, 2U, 2W,
3A, 3B, 3C, 3M, 3M(1), 3Z

(2) Number of Signal Contact Pins

(3) Signal Contact Arrangement

- 1: One-row, double-sided contact
- 2: One-row, single-sided contact (including upper contact and top entry)
- 3: One-row, single-sided contact (lower contact)
- 4: Two-row, double-sided contact
- 5: Two-row, single-sided contact

(4) Terminal Shape

- 4: SMT terminals (top entry)
- 5: SMT terminals (side entry)

(5) Applicable FPC thickness

- 1: 0.3 mm
- 3: 0.2 mm
- 4: 0.12 mm

(6) Terminal Arrangement

- Blank: Standard Arrangement
- 1: Staggered arrangement (forward arrangement)
 - 2: Staggered arrangement (backward arrangement)

(7) Plating

- A: Gold-plated
- B: Gold-plated (flash)
- D: Tin-plated

(8) Identification code

(9) Special Correspondence

- R100: 100pcs
 *Only XF2J, XF2M, XF2W,
XF3M, XF3M(1)

Features of Rotary Backlock Mechanism

Feature 1

Rotary latch is independent of the FPC socket

➔ **The Rotary latch will not release if the FPC is lifted.**

High reliability – A mounted FPC will not detach even if excess force is applied to it.

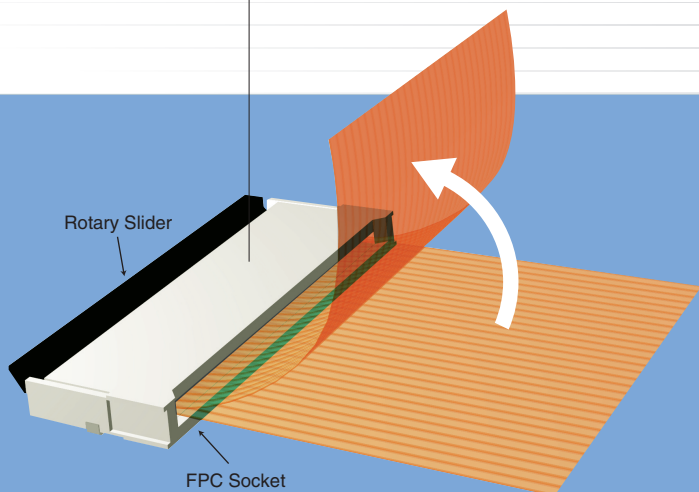

Feature 2

Four-sided housing

➔ **Construction prevents FPC displacement.**

Mounting reliability is enhanced because the FPC is held in a four-sided housing and is unaffected by the slider operation.

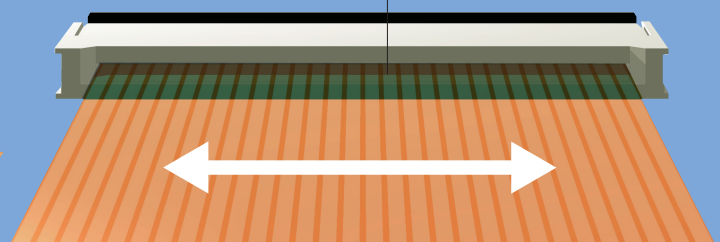

Tradition Rotary Connector

1. Mount the connector.



2. Release the rotary latch.



3. Insert the FPC.

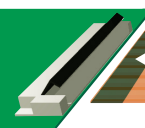

4. Lock the rotary latch.



Rotary Backlock Mechanism Connector

1. Mount the connector.



2. Insert the FPC.

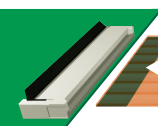

3. Lock the rotary slider.

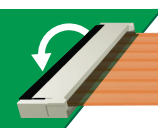

Feature 3

Dual-sided contact

* Except the XF3A series and XF2B-61 pin.

➔ **There is no need to distinguish between the upper and lower FPC connection.**

The contacts make contact from both sides, so there is no need to distinguish between upper and lower contacts when connecting PCBs.

Feature 4

Delivered with the rotary latch open.

➔ **Less work required for FPC Mounting.**

Compared with traditional rotary lock connectors, production efficiency is greatly improved because there is no need to take the additional step of opening the latch.

XF3M

Improved insertion into FPC/FFC cable connectors with sure lock feeling to confirm proper connection.

Improved FPC/FFC Insertion and Lock Feeling

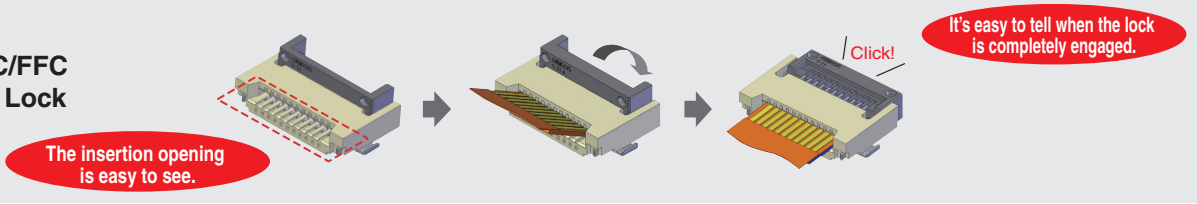

Wide Product Lineup

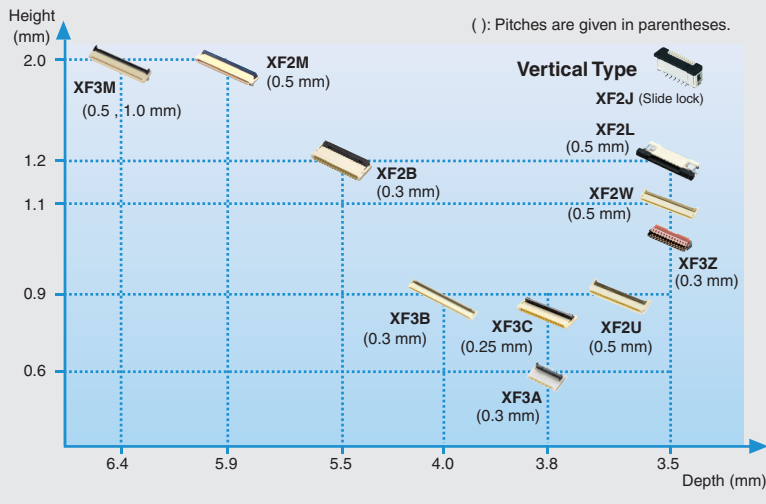

Small Reels Are Available to Fit Small-scale Applications.

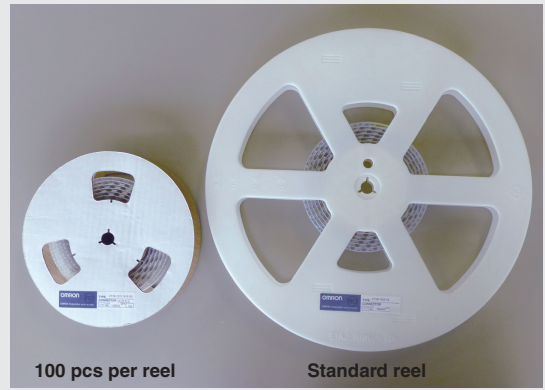

Small Reels= 100 pcs per reel
 * Applicable Connectors : XF2J, XF2M, XF2W, XF3M, XF3M(1)

Applications



Smart Meter



Smart Phone



Handy Terminal



Projector



Printer



Security



Service Robot



Ultrasound

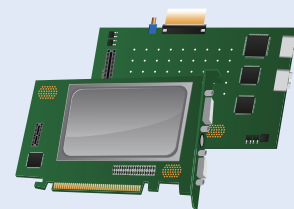

Embedded Module

XF3C

For FPC

Rotary Backlock Connector (0.25-mm Pitch, Dual-sided Contact)

0.25-mm Pitch with Dual-sided Contact and Rotary Backlock Mechanism

- Wide molding wall on the rear bottom of the connector allows greater freedom in board design.
- Dual-sided contact.
- Gold plated with an applicable FPC thickness of 0.12 mm.
- Halogen Free (*)

* OMRON uses the following standard to determine halogen-free construction: 900 ppm max. for Br, 900 ppm max. for Cl, and 1,500 ppm max. for Br+Cl.



RoHS compliant

■ Ratings and Specifications

Rated current	0.2 A AC/DC
Rated voltage	50 V AC/DC
Contact resistance	80 mΩ max. (at 20 mV DC max., 100 mA max.)
Insulation resistance	100 MΩ min. (at 250 V DC)
Dielectric strength	250 V AC for 1 min. (leakage current: 1 mA max.)
Insertion durability	20 times
Ambient operating temperature	-30 to 85 °C (With no icing or condensation)

■ Materials and Finish

Housing	LCP resin (UL94 V-0)/natural
Slider	LCP resin (UL94 V-0)/black
Contacts	Spring copper alloy/nickel substrate (2 μm) Gold-plated contacts (0.15 μm)

■ Dimensions

(Unit: mm)

XF3C-□□45-41A

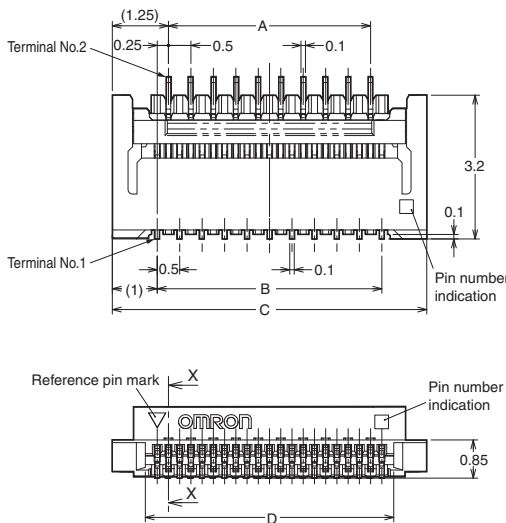
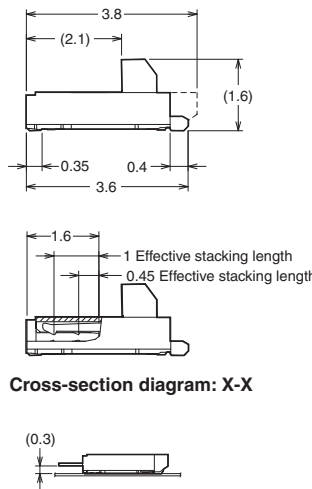

Table of Dimensions

Pins ^{*1}	Model	A	B	C	D
17	XF3C-1745-41A	3.5	4.0	6.0	4.55
19	XF3C-1945-41A	4.0	4.5	6.5	5.05
23	XF3C-2345-41A	5.0	5.5	7.5	6.05
25	XF3C-2545-41A	5.5	6.0	8.0	6.55
35	XF3C-3545-41A	8.0	8.5	10.5	9.05
45	XF3C-4545-41A	10.5	11.0	13.0	11.55
51	XF3C-5145-41A	12.0	12.5	14.5	13.05
59	XF3C-5945-41A	14.0	14.5	16.5	15.05



Cross-section diagram: X-X

PCB Dimensions (TOP VIEW)

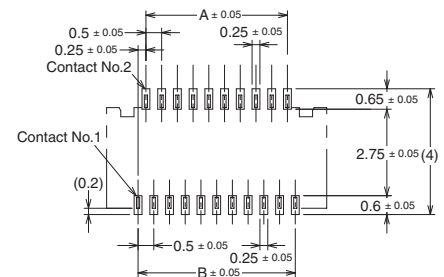

Recommended FPC Dimensions

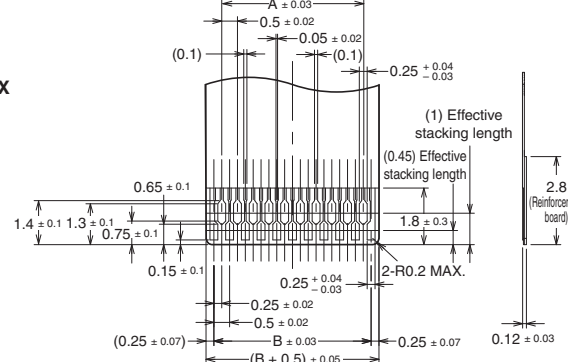

■ Ordering Information

Pins ^{*1}	Model	Quantity per reel (unit) ^{*2}
17	XF3C-1745-41A	2,000
19	XF3C-1945-41A	
23	XF3C-2345-41A	
25	XF3C-2545-41A	
35	XF3C-3545-41A	
45	XF3C-4545-41A	
51	XF3C-5145-41A	
59	XF3C-5945-41A	

- *1. Please consult your OMRON representative for available pin count.
- *2. Please order by integer multiple of the quantity per reel.

XF3A

For FPC

Rotary Backlock Connector (0.3-mm Pitch, Upper sided Contact)

On-board height 0.6 mm, the lowest class profile in the industry.

Rotary Backlock Connectors with 0.3-mm pitch.

- Wide molding wall on the rear bottom of the connector allows greater freedom in board design.
- Upper sided.
- Gold plated with an applicable FPC thickness of 0.12 mm.
- Halogen Free (*)

* OMRON uses the following standard to determine halogen-free construction: 900 ppm max. for Br, 900 ppm max. for Cl, and 1,500 ppm max. for Br+Cl.



RoHS compliant

■ Ratings and Specifications

Rated current	0.2 A AC/DC
Rated voltage	50 V AC/DC
Contact resistance	80 mΩ max. (at 20 mV DC max., 100 mA max.)
Insulation resistance	100 MΩ min. (at 250 V DC)
Dielectric strength	250 V AC for 1 min. (leakage current: 1 mA max.)
Insertion durability	10 times
Ambient operating temperature	-30 to 85 °C (With no icing or condensation)

■ Materials and Finish

Housing	LCP resin (UL94 V-0)/natural
Slider	LCP resin (UL94 V-0)/black
Contacts	Spring copper alloy/nickel substrate (2 μm) Gold-plated contacts (0.15 μm)

■ Dimensions

(Unit: mm)

XF3A-□□55-41A

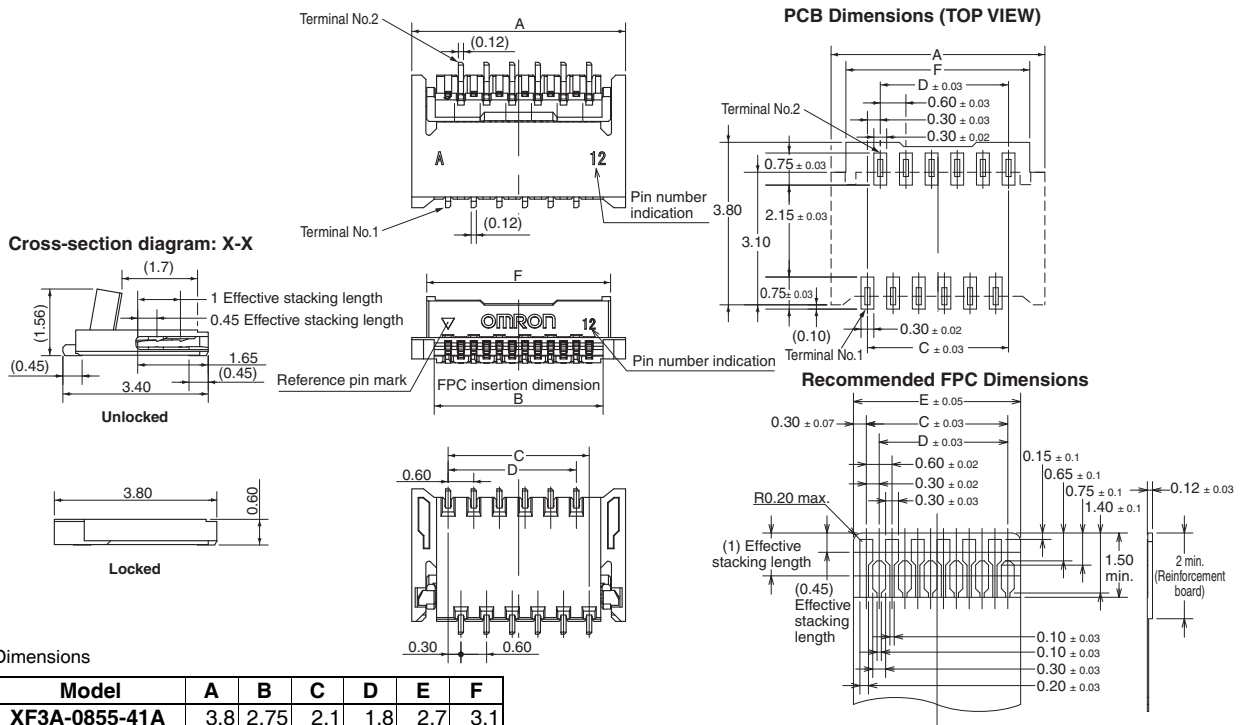

Table of Dimensions

Pins ^{*1}	Model	A	B	C	D	E	F
8	XF3A-0855-41A	3.8	2.75	2.1	1.8	2.7	3.1
12	XF3A-1255-41A	5.0	3.95	3.3	3.0	3.9	4.3
17	XF3A-1755-41A	6.5	5.45	4.8	4.2	5.4	5.8
23	XF3A-2355-41A	8.3	7.25	6.6	6.0	7.2	7.6
25	XF3A-2555-41A	8.9	7.85	7.2	6.6	7.8	8.2
51	XF3A-5155-41A	16.7	15.65	15.0	14.4	15.6	16.0

■ Ordering Information

Pins ^{*1}	Model	Quantity per reel (unit) ^{*2}
8	XF3A-0855-41A	4,000
12	XF3A-1255-41A	
17	XF3A-1755-41A	
23	XF3A-2355-41A	
25	XF3A-2555-41A	
51	XF3A-5155-41A	

*1. Please consult your OMRON representative for available pin count.

*2. Please order by integer multiple of the quantity per reel.

XF3B

For FPC

Rotary Backlock Connector (0.3-mm Pitch, Dual-sided Contact)

Rotary Backlock Mechanism with 0.3-mm Pitch and Low Profile of 0.9 mm

- Wide molding wall on the rear bottom of the connector allows greater freedom in board design.
- Dual-sided contact model to enhance the contact structure of lower sided.
- Gold plated with an applicable FPC thickness of 0.2 mm.
- Halogen Free (*)

* OMRON uses the following standard to determine halogen-free construction: 900 ppm max. for Br, 900 ppm max. for Cl, and 1,500 ppm max. for Br+Cl.

RoHS compliant

■ Ratings and Specifications

Rated current	0.2 A AC/DC
Rated voltage	50 V AC/DC
Contact resistance	80 mΩ max. (at 20 mV DC max., 100 mA max.)
Insulation resistance	100 MΩ min. (at 250 V DC)
Dielectric strength	250 V AC for 1 min. (leakage current: 1 mA max.)
Insertion durability	20 times
Ambient operating temperature	-30 to 85 °C (With no icing or condensation)

■ Materials and Finish

Housing	LCP resin (UL94 V-0)/natural
Slider	LCP resin (UL94 V-0)/brown
Contacts	Spring copper alloy/nickel substrate (2 μm) Gold-plated contacts (0.15 μm)



■ Dimensions

(Unit: mm)

XF3B-□□45-31A

XF3B-□□45-31AE

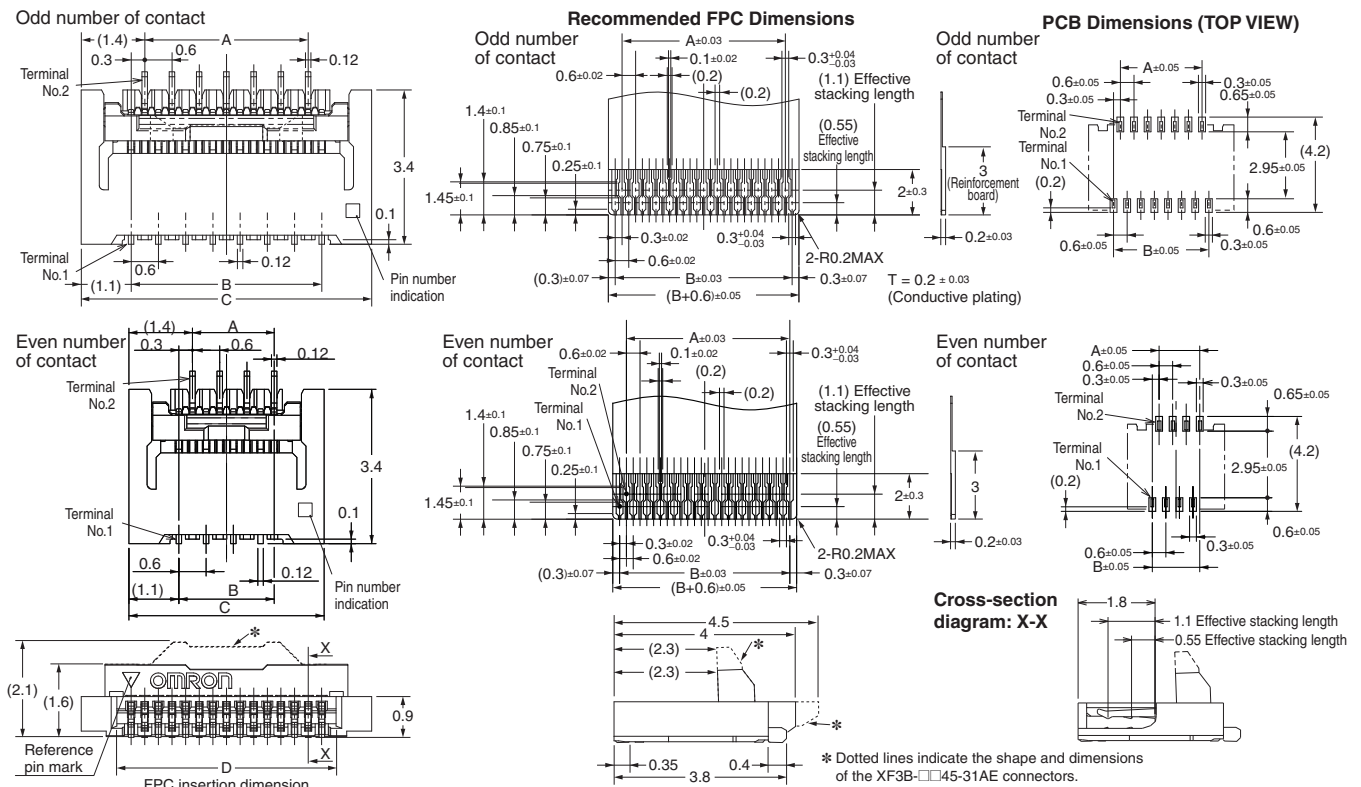

Table of Dimensions

Pins*1	Model	A	B	C	D
8	XF3B-0845-31A	1.8	2.1	4.3	2.75
19	XF3B-1945-31A	4.8	5.4	7.6	6.05
25	XF3B-2545-31A	6.6	7.2	9.4	7.85

Pins*1	Model	A	B	C	D
35	XF3B-3545-31A	9.6	10.2	12.4	10.85
51	XF3B-5145-31AE	14.4	15.0	17.2	15.65
67	XF3B-6745-31AE	19.2	19.8	22.0	20.45

■ Ordering Information

Pins*1	Model	Quantity per reel (unit)*2
8	XF3B-0845-31A	2,000
19	XF3B-1945-31A	
25	XF3B-2545-31A	
35	XF3B-3545-31A	

Pins*1	Model	Quantity per reel (unit)*2
51	XF3B-5145-31AE	1,500
67	XF3B-6745-31AE	

*1. Please consult your OMRON representative for available pin count.
*2. Please order by integer multiple of the quantity per reel.

Rotary Backlock Mechanism with 0.3-mm Pitch

- Wide molding wall on the rear bottom of the connector allows greater freedom in board design.
- Dual-sided contact reduces the number of parts.
- Gold plated with an applicable FPC thickness of 0.2 mm.
- Halogen Free (*)

* OMRON uses the following standard to determine halogen-free construction: 900 ppm max. for Br, 900 ppm max. for Cl, and 1,500 ppm max. for Br+Cl.

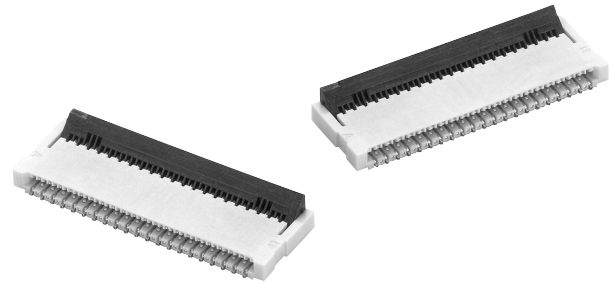

RoHS compliant

■ Ratings and Specifications

Rated current	0.2 A AC/DC
Rated voltage	50 V AC/DC
Contact resistance	50 mΩ max. (at 20 mV DC max., 100 mA max.)
Insulation resistance	100 MΩ min. (at 250 V DC)
Dielectric strength	250 V AC for 1 min. (leakage current: 1 mA max.)
Insertion durability	20 times
Ambient operating temperature	-30 to 85 °C (With no icing or condensation)

■ Materials and Finish

Housing	LCP resin (UL94 V-0)/natural
Slider	LCP resin (UL94 V-0)/black
Contacts	Spring copper alloy/nickel substrate (2 μm) Gold-plated contacts (0.15 μm)

■ Dimensions

(Unit: mm)

XF2B-□□□5-31A

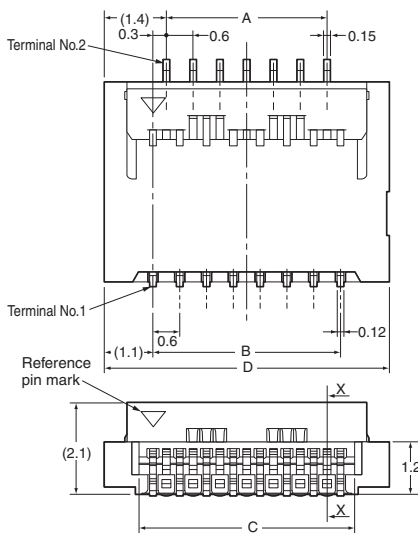

Cross-section diagram: X-X

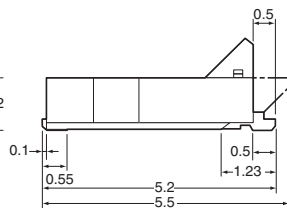

PCB Dimensions (TOP VIEW)

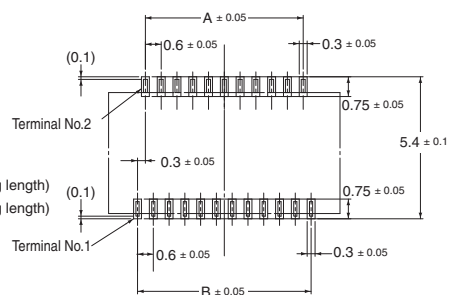

Recommended FPC Dimensions

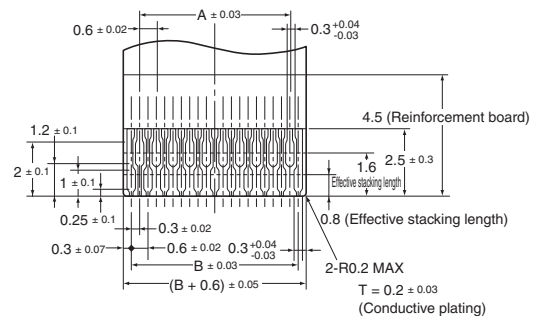

Table of Dimensions

Pins ^{*1}	Model	A	B	C	D
17	XF2B-1745-31A	4.2	4.8	5.5	7.0
21	XF2B-2145-31A	5.4	6.0	6.7	8.2
23	XF2B-2345-31A	6.0	6.6	7.3	8.8
25	XF2B-2545-31A	6.6	7.2	7.9	9.4
27	XF2B-2745-31A	7.2	7.8	8.5	10.0
31	XF2B-3145-31A	8.4	9.0	9.7	11.2
33	XF2B-3345-31A	9.0	9.6	10.3	11.8
35	XF2B-3545-31A	9.6	10.2	10.9	12.4
39	XF2B-3945-31A	10.8	11.4	12.1	13.6
41	XF2B-4145-31A	11.4	12.0	12.7	14.2
45	XF2B-4545-31A	12.6	13.2	13.9	15.4
51	XF2B-5145-31A	14.4	15.0	15.7	17.2
61	XF2B-6155-31A	17.4	18.0	18.7	20.2

■ Ordering Information

Pins ^{*1}	Model	Pins ^{*1}	Model	Quantity per reel (unit) ^{*2}
17	XF2B-1745-31A	35	XF2B-3545-31A	1,500
21	XF2B-2145-31A	39	XF2B-3945-31A	
23	XF2B-2345-31A	41	XF2B-4145-31A	
25	XF2B-2545-31A	45	XF2B-4545-31A	
27	XF2B-2745-31A	51	XF2B-5145-31A	
31	XF2B-3145-31A	61	XF2B-6155-31A ^{*3}	
33	XF2B-3345-31A	-	-	

- *1. Please consult your OMRON representative for available pin count.
- *2. Please order by integer multiple of the quantity per reel.
- *3. Upper sided.

XF3Z

Rotary Frontlock Connector (0.3-mm Pitch, Lower sided Contact)

For FPC

High-reliability rotary-front-lock with 0.3-mm pitch and low profile

- Ultra-slim connector with a depth of 3.5 mm.
- Wide molding wall on the rear bottom of the connector allows greater freedom in board design.
- Slider open locking mechanism makes work efficient.
- Gold plated with an applicable FPC thickness of 0.2 mm.
- Halogen Free (*)

* OMRON uses the following standard to determine halogen-free construction: 900 ppm max. for Br, 900 ppm max. for Cl, and 1,500 ppm max. for Br+Cl

RoHS compliant

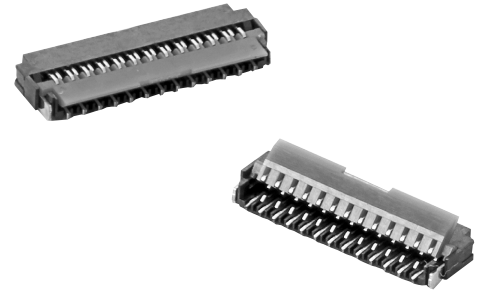

■ Ratings and Specifications

Rated current	0.2 A AC/DC
Rated voltage	50 V AC/DC
Contact resistance	80 mΩ max. (at 20 mV DC max., 100 mA max.)
Insulation resistance	100 MΩ min. (at 250 V DC)
Dielectric strength	250 V AC for 1 min. (leakage current: 1 mA max.)
Insertion durability	20 times
Ambient operating temperature	-55 to 85 °C (With no icing or condensation)

■ Materials and Finish

Housing	LCP resin (UL94 V-0)/black
Slider	PA resin (UL94 HB)/brown
Contacts	Spring copper alloy/nickel substrate (1.5 μm) Gold-plated contacts (flash)
Hold-down	Copper alloy/tin-plated (1 μm)

■ Dimensions

(Unit: mm)

XF3Z-□□55-31B

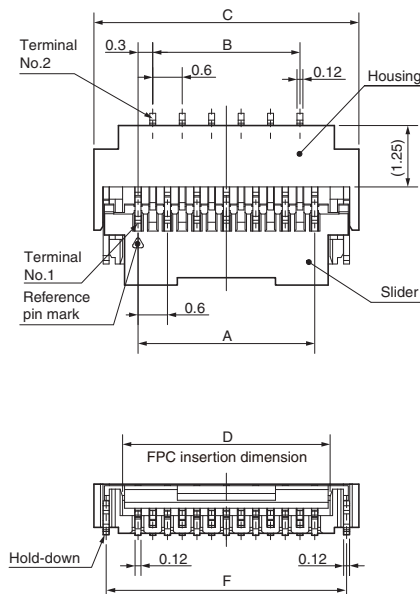

PCB Dimensions (TOP VIEW)

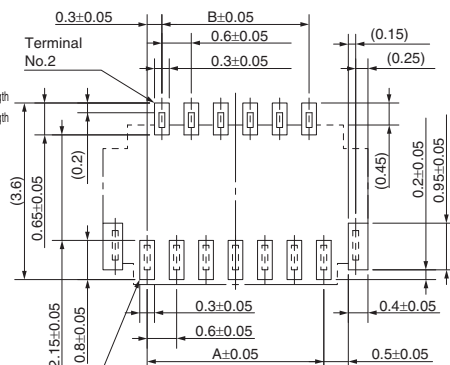

Recommended FPC Dimensions

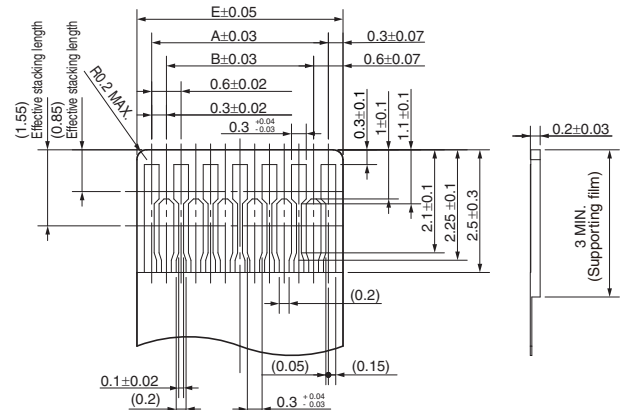

Table of Dimensions

Pins ^{*1}	Model	A	B	C	D	E	F
13	XF3Z-1355-31B	3.6	3.0	5.4	4.23	4.2	4.9
25	XF3Z-2555-31B	7.2	6.6	9.0	7.83	7.8	8.5
35	XF3Z-3555-31B	10.2	9.6	12.0	10.83	10.8	11.5
39	XF3Z-3955-31B	11.4	10.8	13.2	12.03	12.0	12.7

■ Ordering Information

Pins ^{*1}	Model	Quantity per reel (unit) ^{*2}
13	XF3Z-1355-31B	3000
25	XF3Z-2555-31B	
35	XF3Z-3555-31B	
39	XF3Z-3955-31B	

- *1. Please consult your OMRON representative for available pin count.
*2. Please order by integer multiple of the quantity per reel.

Rotary Backlock Mechanism with Depth of 3.5-mm and Low Profile of 0.9 mm

- Ultra-slim connector with a depth of 3.5 mm.
- Dual-sided contact reduces the number of parts.
- Wide molding wall on the rear bottom of the connector allows greater freedom in board design.
- Gold plated with an applicable FPC thickness of 0.2 mm.
- Halogen Free (*)

* OMRON uses the following standard to determine halogen-free construction: 900 ppm max. for Br, 900 ppm max. for Cl, and 1,500 ppm max. for Br+Cl.

RoHS compliant



■ Ratings and Specifications

Rated current	0.5 A AC/DC
Rated voltage	50 V AC/DC
Contact resistance	60 mΩ max. (at 20 mV DC max., 100 mA max.)
Insulation resistance	100 MΩ min. (at 250 V DC)
Dielectric strength	250 V AC for 1 min. (leakage current: 1 mA max.)
Insertion durability	20 times
Ambient operating temperature	-30 to 85 °C (With no icing or condensation)

■ Materials and Finish

Housing	LCP resin (UL94 V-0)/natural
Slider	LCP resin (UL94 V-0)/black
Contacts	Spring copper alloy/nickel substrate (2 μm) Gold-plated contacts (0.15 μm)
Hold-down	Copper alloy/tin-plated (2 μm)

■ Dimensions

(Unit: mm)

XF2U-□□15-3A

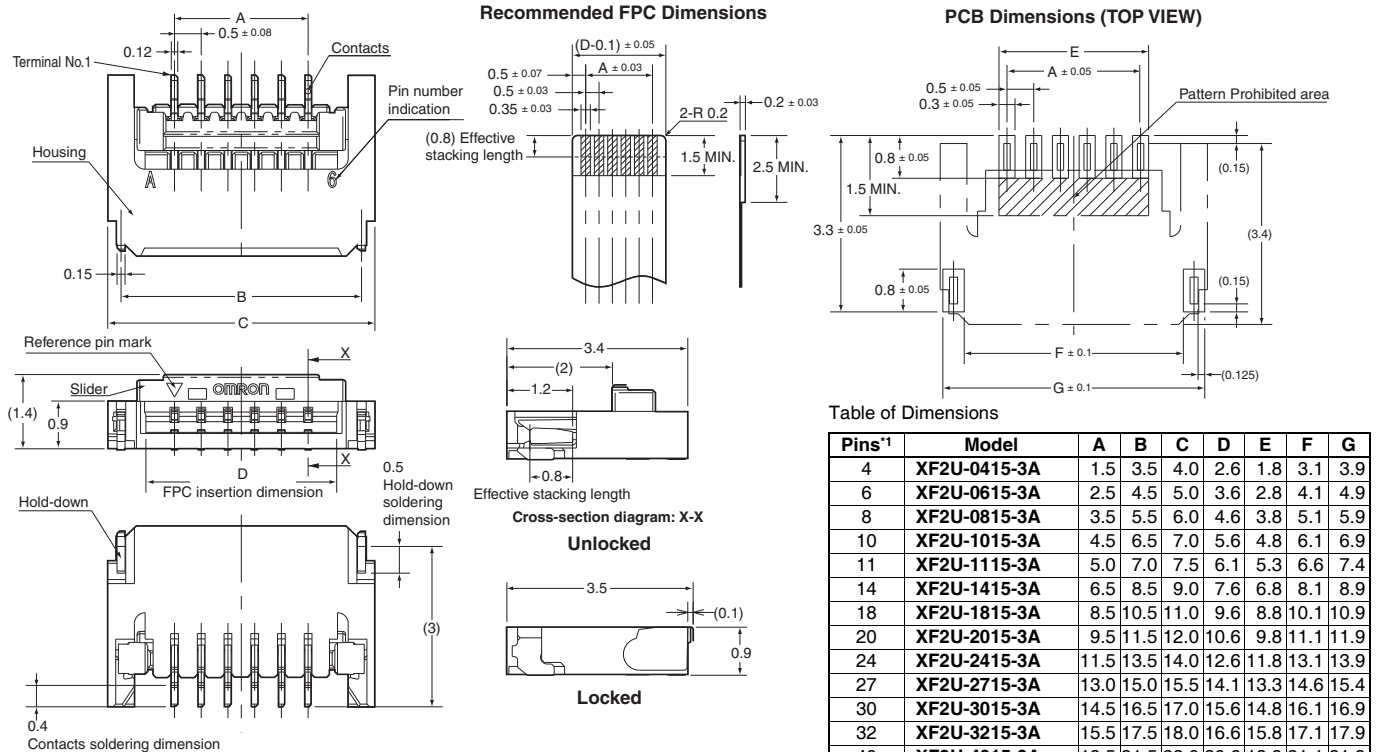

■ Ordering Information

Pins ^{*1}	Model	Quantity per reel (unit) ^{*2}
4	XF2U-0415-3A	3,000
6	XF2U-0615-3A	
8	XF2U-0815-3A	
10	XF2U-1015-3A	
11	XF2U-1115-3A	
14	XF2U-1415-3A	
18	XF2U-1815-3A	

Pins ^{*1}	Model	Quantity per reel (unit) ^{*2}
20	XF2U-2015-3A	3,000
24	XF2U-2415-3A	
27	XF2U-2715-3A	
30	XF2U-3015-3A	
32	XF2U-3215-3A	
40	XF2U-4015-3A	

*1. Please consult your OMRON representative for available pin count.

*2. Please order by integer multiple of the quantity per reel.

XF2W

For FPC/FFC

Rotary Backlock Connector (0.5-mm Pitch, Dual-sided Contact)

Rotary Backlock Mechanism with 0.5-mm Pitch and Low Profile of 1.1 mm

- Two models available: Low profile connector with a depth of 3.5 mm and easy-operation connector with long slider.
- Dual-sided contact reduces the number of parts.
- Wide molding wall on the rear bottom of the connector allows greater freedom in board design.
- Gold plated with an applicable FPC/FFC thickness of 0.3 mm.
- Halogen Free (*)

* OMRON uses the following standard to determine halogen-free construction: 900 ppm max. for Br, 900 ppm max. for Cl, and 1,500 ppm max. for Br+Cl.



RoHS compliant

■ Ratings and Specifications

Rated current	0.5 A AC/DC
Rated voltage	50 V AC/DC
Contact resistance	60 mΩ max. (at 20 mV DC max., 100 mA max.)
Insulation resistance	100 MΩ min. (at 250 V DC)
Dielectric strength	250 V AC for 1 min. (leakage current: 1 mA max.)
Insertion durability	20 times
Ambient operating temperature	-30 to 85 °C (With no icing or condensation)

■ Materials and Finish

Housing	LCP resin (UL94 V-0)/natural
Slider	LCP resin (UL94 V-0)/brown
Contacts	Spring copper alloy/nickel substrate (2 μm) Gold-plated contacts (0.15 μm)
Hold-down	Copper alloy/tin-plated (2 μm)

■ Dimensions

(Unit: mm)

XF2W-□□15-1A

XF2W-□□15-1AE

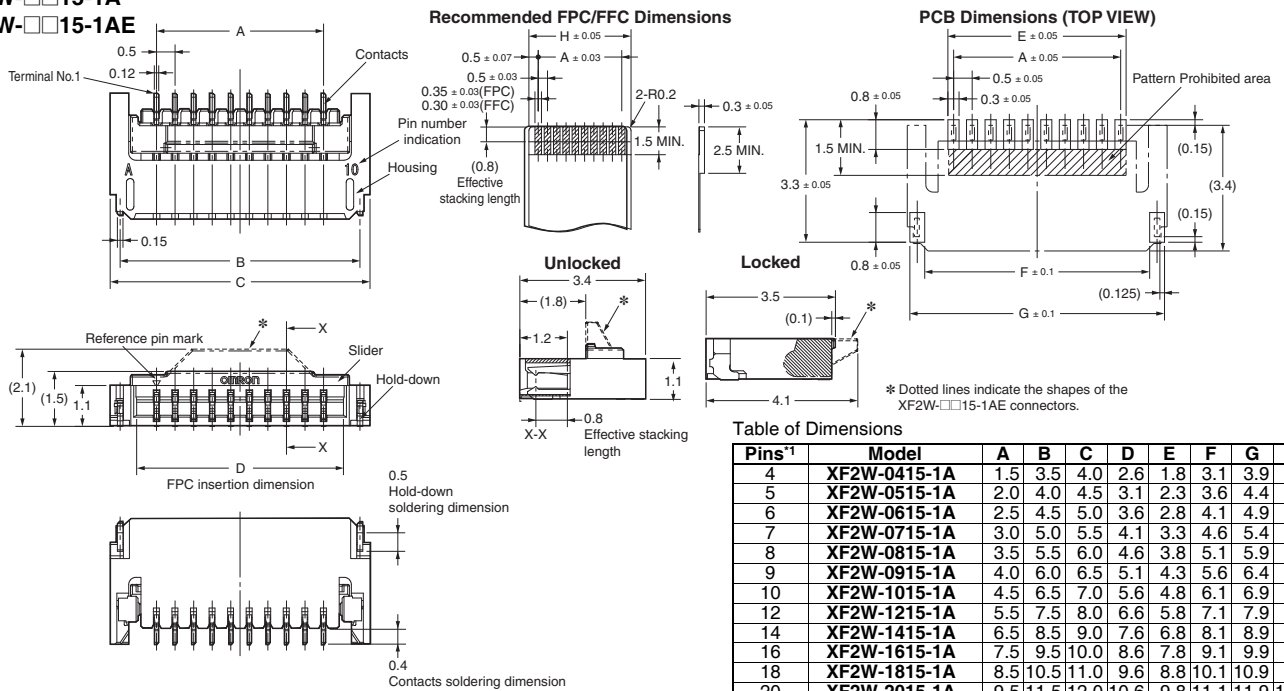

Table of Dimensions

Pins ¹	Model	A	B	C	D	E	F	G	H
4	XF2W-0415-1A	1.5	3.5	4.0	2.6	1.8	3.1	3.9	2.5
5	XF2W-0515-1A	2.0	4.0	4.5	3.1	2.3	3.6	4.4	3.0
6	XF2W-0615-1A	2.5	4.5	5.0	3.6	2.8	4.1	4.9	3.5
7	XF2W-0715-1A	3.0	5.0	5.5	4.1	3.3	4.6	5.4	4.0
8	XF2W-0815-1A	3.5	5.5	6.0	4.6	3.8	5.1	5.9	4.5
9	XF2W-0915-1A	4.0	6.0	6.5	5.1	4.3	5.6	6.4	5.0
10	XF2W-1015-1A	4.5	6.5	7.0	5.6	4.8	6.1	6.9	5.5
12	XF2W-1215-1A	5.5	7.5	8.0	6.6	5.8	7.1	7.9	6.5
14	XF2W-1415-1A	6.5	8.5	9.0	7.6	6.8	8.1	8.9	7.5
16	XF2W-1615-1A	7.5	9.5	10.0	8.6	7.8	9.1	9.9	8.5
18	XF2W-1815-1A	8.5	10.5	11.0	9.6	8.8	10.1	10.9	9.5
20	XF2W-2015-1A	9.5	11.5	12.0	10.6	9.8	11.1	11.9	10.5
24	XF2W-2415-1A	11.5	13.5	14.0	12.6	11.8	13.1	13.9	12.5
26	XF2W-2615-1A	12.5	14.5	15.0	13.6	12.8	14.1	14.9	13.5
40	XF2W-4015-1A	19.5	21.5	22.0	20.6	19.8	21.1	21.9	20.5
45	XF2W-4515-1AE	22.0	24.0	24.5	23.1	22.3	23.6	24.4	23.0
50	XF2W-5015-1AE	24.5	26.5	27.0	25.6	24.8	26.1	26.9	25.5
55	XF2W-5515-1AE	27.0	29.0	29.5	28.1	27.3	28.6	29.4	28.0
60	XF2W-6015-1AE	29.5	31.5	32.0	30.6	29.8	31.1	31.9	30.5
64	XF2W-6415-1AE	31.5	33.5	34.0	32.6	31.8	33.1	33.9	32.5

■ Ordering Information

2000pcs per reel

Pins ¹	Model	Pins ¹	Model	Pins ¹	Model	Pins ¹	Model	Quantity per reel (unit) ²
4	XF2W-0415-1A	9	XF2W-0915-1A	18	XF2W-1815-1A	45	XF2W-4515-1AE	2,000
5	XF2W-0515-1A	10	XF2W-1015-1A	20	XF2W-2015-1A	50	XF2W-5015-1AE	
6	XF2W-0615-1A	12	XF2W-1215-1A	24	XF2W-2415-1A	55	XF2W-5515-1AE	
7	XF2W-0715-1A	14	XF2W-1415-1A	26	XF2W-2615-1A	60	XF2W-6015-1AE	
8	XF2W-0815-1A	16	XF2W-1615-1A	40	XF2W-4015-1A	64	XF2W-6415-1AE	

100pcs per reel

Pins ¹	Model	Pins ¹	Model	Pins ¹	Model	Pins ¹	Model	Quantity per reel (unit) ²
4	XF2W-0415-1A-R100	9	XF2W-0915-1A-R100	20	XF2W-2015-1A-R100	50	XF2W-5015-1AE-R100	100
5	XF2W-0515-1A-R100	10	XF2W-1015-1A-R100	24	XF2W-2415-1A-R100	55	XF2W-5515-1AE-R100	
6	XF2W-0615-1A-R100	14	XF2W-1415-1A-R100	26	XF2W-2615-1A-R100	60	XF2W-6015-1AE-R100	
7	XF2W-0715-1A-R100	16	XF2W-1615-1A-R100	40	XF2W-4015-1A-R100	64	XF2W-6415-1AE-R100	
8	XF2W-0815-1A-R100	18	XF2W-1815-1A-R100	45	XF2W-4515-1AE-R100			

*1. Please consult your OMRON representative for available pin count.

*2. Please order by integer multiple of the quantity per reel.

XF3M

For FPC/FFC

Rotary Backlock Connector (0.5-mm Pitch, 1.0-mm Pitch, Dual sided, Upper sided Contact)

Rotary Backlock Connectors Provide Improved Insertion of FPC/FFC Cables and helps Confirm Proper Connection with Sure Lock Feel.

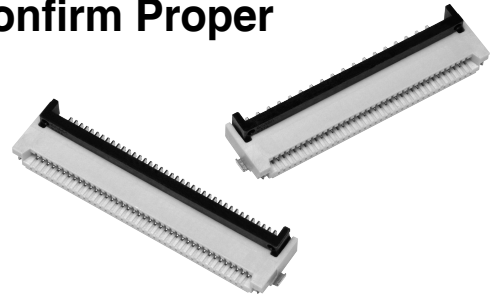

- Models available with 0.5-mm or 1.0-mm pitch.
- Models available with dual-sided contacts or upper sided. (Models with upper sided come only with a 0.5-mm pitch.)
- Models available with gold or Tin-plated. (Tin-plated is available only with models with dual-sided contacts.)
- Models with 80 pins (multiple type) available with 0.5-mm pitch.
- Applicable FPC/FFC thickness of 0.3 mm.
- Halogen Free (*)

* OMRON uses the following standard to determine halogen-free construction: 900 ppm max. for Br, 900 ppm max. for Cl, and 1,500 ppm max. for Br+Cl.

RoHS compliant

■ Ratings and Specifications

Rated current	0.5 A AC/DC
Rated voltage	50 V AC/DC
Contact resistance	50 mΩ max. (at 20 mV DC max., 100 mA max.)
Insulation resistance	100 MΩ min. (at 250 V DC)
Dielectric strength	250 V AC for 1 min. (leakage current: 1 mA max.)
Insertion durability	Gold-plated: 20 times Tin-plated: 10 times
Ambient operating temperature	-30 to 85 °C (With no icing or condensation)

■ Materials and Finish

Model	Dual-sided Contact Models		Upper sided Models
	Gold-plated	Tin-plated	Gold-plated
Housing	LCP resin (UL94 V-0)/natural		LCP resin (UL94 V-0)/gray
Slider	LCP resin (UL94 V-0)/black		
Contacts	Spring copper alloy/nickel substrate (1.5 μm)		
	Gold-plated contacts (flash)	Tin-plated contacts (1 μm)	Gold-plated contacts (flash)
Hold-down	Copper alloy/tin-plated (1 μm)		

■ Models

Contact type Pitch	Dual-sided contact		Upper sided	
	Contacts	Model	Contacts	Model
0.5 mm	Gold-plated (flash)	XF3M-□□15-1B□	Gold-plated (flash)	XF3M-□□25-1B
	Tin-plated	XF3M-□□15-1D		
1.0 mm	Gold-plated (flash)	XF3M(1)-□□15-1B		
	Tin-plated	XF3M(1)-□□15-1D		

XF3M

XF3M Rotary Backlock Connector (0.5-mm Pitch, 1.0-mm Pitch, Dual sided, Upper sided Contact)

XF3M 0.5-mm pitch model

■ Dimensions

(Unit: mm)

XF3M-□□15-1B
 XF3M-□□15-1BE
 XF3M-□□15-1D
 XF3M-□□25-1B

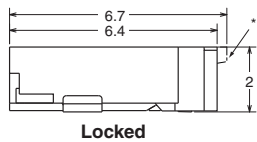
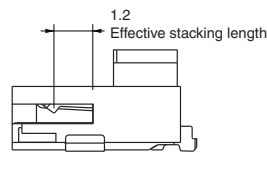
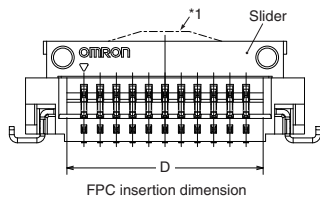
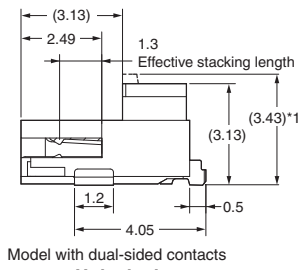
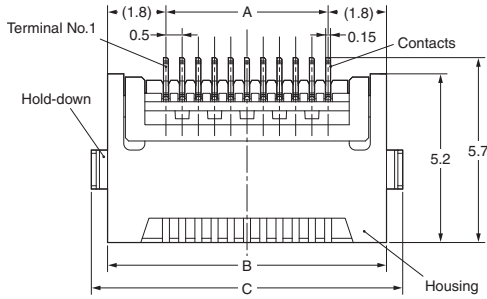

PCB Dimensions (TOP VIEW)

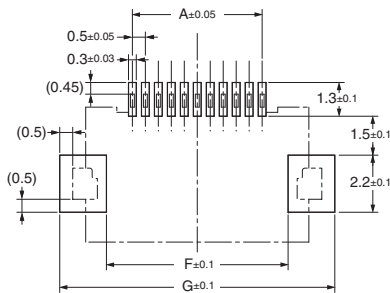

Recommended FPC/FFC Dimensions

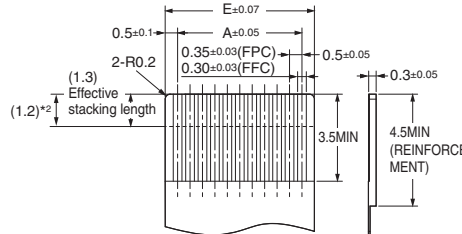

Table of Dimension

Pins ^{*1}	A	B	C	D	E	F	G
4	1.5	5.1	6.1	2.55	2.5	3.5	7.1
5	2.0	5.6	6.6	3.05	3.0	4.0	7.6
6	2.5	6.1	7.1	3.55	3.5	4.5	8.1
7	3.0	6.6	7.6	4.05	4.0	5.0	8.6
8	3.5	7.1	8.1	4.55	4.5	5.5	9.1
9	4.0	7.6	8.6	5.05	5.0	6.0	9.6
10	4.5	8.1	9.1	5.55	5.5	6.5	10.1
11	5.0	8.6	9.6	6.05	6.0	7.0	10.6
12	5.5	9.1	10.1	6.55	6.5	7.5	11.1
13	6.0	9.6	10.6	7.05	7.0	8.0	11.6
14	6.5	10.1	11.1	7.55	7.5	8.5	12.1
15	7.0	10.6	11.6	8.05	8.0	9.0	12.6
16	7.5	11.1	12.1	8.55	8.5	9.5	13.1
17	8.0	11.6	12.6	9.05	9.0	10.0	13.6
18	8.5	12.1	13.1	9.55	9.5	10.5	14.1
19	9.0	12.6	13.6	10.05	10.0	11.0	14.6
20	9.5	13.1	14.1	10.55	10.5	11.5	15.1
21	10.0	13.6	14.6	11.05	11.0	12.0	15.6
22	10.5	14.1	15.1	11.55	11.5	12.5	16.1
23	11.0	14.6	15.6	12.05	12.0	13.0	16.6
24	11.5	15.1	16.1	12.55	12.5	13.5	17.1
25	12.0	15.6	16.6	13.05	13.0	14.0	17.6
26	12.5	16.1	17.1	13.55	13.5	14.5	18.1
28	13.5	17.1	18.1	14.55	14.5	15.5	19.1
29	14.0	17.6	18.6	15.05	15.0	16.0	19.6
30	14.5	18.1	19.1	15.55	15.5	16.5	20.1
31	15.0	18.6	19.6	16.05	16.0	17.0	20.6
32	15.5	19.1	20.1	16.55	16.5	17.5	21.1
33	16.0	19.6	20.6	17.05	17.0	18.0	21.6
34	16.5	20.1	21.1	17.55	17.5	18.5	22.1
35	17.0	20.6	21.6	18.05	18.0	19.0	22.6
36	17.5	21.1	22.1	18.55	18.5	19.5	23.1
37	18.0	21.6	22.6	19.05	19.0	20.0	23.6
38	18.5	22.1	23.1	19.55	19.5	20.5	24.1
40	19.5	23.1	24.1	20.55	20.5	21.5	25.1
41	20.0	23.6	24.6	21.05	21.0	22.0	25.6
42	20.5	24.1	25.1	21.55	21.5	22.5	26.1
45	22.0	25.6	26.6	23.05	23.0	24.0	27.6
50	24.5	28.1	29.1	25.55	25.5	26.5	30.1
51	25.0	28.6	29.6	26.05	26.0	27.0	30.6
53	26.0	29.6	30.6	27.05	27.0	28.0	31.6
54	26.5	30.1	31.1	27.55	27.5	28.5	32.1
55	27.0	30.6	31.6	28.05	28.0	29.0	32.6
57	28.0	31.6	32.6	29.05	29.0	30.0	33.6
60	29.5	33.1	34.1	30.55	30.5	31.5	35.1
80	39.5	43.1	44.1	40.55	40.5	41.5	45.1

*1. Dotted lines indicate the shape and dimensions of the XF3M-8015-1BE Connectors.
 *2. For the XF3M-□□25-1B Connectors.

■ Ordering Information

● Dual-sided Contact Models - Gold-plated (flash)

1500pcs per reel

Pins ^{*1}	Model	Pins ^{*1}	Model	Pins ^{*1}	Model	Pins ^{*1}	Model	Quantity per reel (unit) ^{*2}
4	XF3M-0415-1B	16	XF3M-1615-1B	29	XF3M-2915-1B	42	XF3M-4215-1B	1,500
5	XF3M-0515-1B	17	XF3M-1715-1B	30	XF3M-3015-1B	45	XF3M-4515-1B	
6	XF3M-0615-1B	18	XF3M-1815-1B	31	XF3M-3115-1B	50	XF3M-5015-1B	
7	XF3M-0715-1B	19	XF3M-1915-1B	32	XF3M-3215-1B	51	XF3M-5115-1B	
8	XF3M-0815-1B	20	XF3M-2015-1B	33	XF3M-3315-1B	53	XF3M-5315-1B	
9	XF3M-0915-1B	21	XF3M-2115-1B	34	XF3M-3415-1B	54	XF3M-5415-1B	
10	XF3M-1015-1B	22	XF3M-2215-1B	35	XF3M-3515-1B	55	XF3M-5515-1B	
11	XF3M-1115-1B	23	XF3M-2315-1B	36	XF3M-3615-1B	57	XF3M-5715-1B	
12	XF3M-1215-1B	24	XF3M-2415-1B	37	XF3M-3715-1B	60	XF3M-6015-1B	
13	XF3M-1315-1B	25	XF3M-2515-1B	38	XF3M-3815-1B			
14	XF3M-1415-1B	26	XF3M-2615-1B	40	XF3M-4015-1B			
15	XF3M-1515-1B	28	XF3M-2815-1B	41	XF3M-4115-1B			

1000pcs per reel

Pins ^{*1}	Model	Quantity per reel (unit) ^{*2}
80	XF3M-8015-1BE	1,000

XF3M Rotary Backlock Connector (0.5-mm Pitch, 1.0-mm Pitch, Dual sided, Upper sided Contact)

100pcs per reel

Pins ^{*1}	Model	Pins ^{*1}	Model	Pins ^{*1}	Model	Pins ^{*1}	Model	Quantity per reel (unit) ^{*2}
4	XF3M-0415-1B-R100	16	XF3M-1615-1B-R100	29	XF3M-2915-1B-R100	42	XF3M-4215-1B-R100	100
5	XF3M-0515-1B-R100	17	XF3M-1715-1B-R100	30	XF3M-3015-1B-R100	45	XF3M-4515-1B-R100	
6	XF3M-0615-1B-R100	18	XF3M-1815-1B-R100	31	XF3M-3115-1B-R100	50	XF3M-5015-1B-R100	
7	XF3M-0715-1B-R100	19	XF3M-1915-1B-R100	32	XF3M-3215-1B-R100	51	XF3M-5115-1B-R100	
8	XF3M-0815-1B-R100	20	XF3M-2015-1B-R100	33	XF3M-3315-1B-R100	53	XF3M-5315-1B-R100	
9	XF3M-0915-1B-R100	21	XF3M-2115-1B-R100	34	XF3M-3415-1B-R100	54	XF3M-5415-1B-R100	
10	XF3M-1015-1B-R100	22	XF3M-2215-1B-R100	35	XF3M-3515-1B-R100	55	XF3M-5515-1B-R100	
11	XF3M-1115-1B-R100	23	XF3M-2315-1B-R100	36	XF3M-3615-1B-R100	57	XF3M-5715-1B-R100	
12	XF3M-1215-1B-R100	24	XF3M-2415-1B-R100	37	XF3M-3715-1B-R100	60	XF3M-6015-1B-R100	
13	XF3M-1315-1B-R100	25	XF3M-2515-1B-R100	38	XF3M-3815-1B-R100	80	XF3M-8015-1BE-R100	
14	XF3M-1415-1B-R100	26	XF3M-2615-1B-R100	40	XF3M-4015-1B-R100			
15	XF3M-1515-1B-R100	28	XF3M-2815-1B-R100	41	XF3M-4115-1B-R100			

● Dual-sided Contact Models - Tin-plated

1500pcs per reel

Pins ^{*1}	Model	Pins ^{*1}	Model	Pins ^{*1}	Model	Pins ^{*1}	Model	Quantity per reel (unit) ^{*2}
(4)	XF3M-0415-1D	(14)	XF3M-1415-1D	(24)	XF3M-2415-1D	(35)	XF3M-3515-1D	1,500
(5)	XF3M-0515-1D	(15)	XF3M-1515-1D	(25)	XF3M-2515-1D	(36)	XF3M-3615-1D	
(6)	XF3M-0615-1D	(16)	XF3M-1615-1D	(26)	XF3M-2615-1D	(37)	XF3M-3715-1D	
(7)	XF3M-0715-1D	(17)	XF3M-1715-1D	(28)	XF3M-2815-1D	(38)	XF3M-3815-1D	
(8)	XF3M-0815-1D	(18)	XF3M-1815-1D	(29)	XF3M-2915-1D	(40)	XF3M-4015-1D	
(9)	XF3M-0915-1D	(19)	XF3M-1915-1D	(30)	XF3M-3015-1D	(41)	XF3M-4115-1D	
10	XF3M-1015-1D	(20)	XF3M-2015-1D	(31)	XF3M-3115-1D	(42)	XF3M-4215-1D	
(11)	XF3M-1115-1D	(21)	XF3M-2115-1D	(32)	XF3M-3215-1D	(45)	XF3M-4515-1D	
(12)	XF3M-1215-1D	(22)	XF3M-2215-1D	(33)	XF3M-3315-1D	(50)	XF3M-5015-1D	
(13)	XF3M-1315-1D	(23)	XF3M-2315-1D	(34)	XF3M-3415-1D			

100pcs per reel

Pins ^{*1}	Model	Pins ^{*1}	Model	Pins ^{*1}	Model	Pins ^{*1}	Model	Quantity per reel (unit) ^{*2}
(4)	XF3M-0415-1D-R100	(14)	XF3M-1415-1D-R100	(24)	XF3M-2415-1D-R100	(35)	XF3M-3515-1D-R100	100
(5)	XF3M-0515-1D-R100	(15)	XF3M-1515-1D-R100	(25)	XF3M-2515-1D-R100	(36)	XF3M-3615-1D-R100	
(6)	XF3M-0615-1D-R100	(16)	XF3M-1615-1D-R100	(26)	XF3M-2615-1D-R100	(37)	XF3M-3715-1D-R100	
(7)	XF3M-0715-1D-R100	(17)	XF3M-1715-1D-R100	(28)	XF3M-2815-1D-R100	(38)	XF3M-3815-1D-R100	
(8)	XF3M-0815-1D-R100	(18)	XF3M-1815-1D-R100	(29)	XF3M-2915-1D-R100	(40)	XF3M-4015-1D-R100	
(9)	XF3M-0915-1D-R100	(19)	XF3M-1915-1D-R100	(30)	XF3M-3015-1D-R100	(41)	XF3M-4115-1D-R100	
10	XF3M-1015-1D-R100	(20)	XF3M-2015-1D-R100	(31)	XF3M-3115-1D-R100	(42)	XF3M-4215-1D-R100	
(11)	XF3M-1115-1D-R100	(21)	XF3M-2115-1D-R100	(32)	XF3M-3215-1D-R100	(45)	XF3M-4515-1D-R100	
(12)	XF3M-1215-1D-R100	(22)	XF3M-2215-1D-R100	(33)	XF3M-3315-1D-R100	(50)	XF3M-5015-1D-R100	
(13)	XF3M-1315-1D-R100	(23)	XF3M-2315-1D-R100	(34)	XF3M-3415-1D-R100			

● Upper-sided Models - Gold-plated (flash)

1500pcs per reel

Pins ^{*1}	Model	Pins ^{*1}	Model	Pins ^{*1}	Model	Pins ^{*1}	Model	Quantity per reel (unit) ^{*2}
(4)	XF3M-0425-1B	13	XF3M-1325-1B	22	XF3M-2225-1B	(32)	XF3M-3225-1B	1,500
(5)	XF3M-0525-1B	14	XF3M-1425-1B	(23)	XF3M-2325-1B	(33)	XF3M-3325-1B	
(6)	XF3M-0625-1B	(15)	XF3M-1525-1B	24	XF3M-2425-1B	(34)	XF3M-3425-1B	
7	XF3M-0725-1B	16	XF3M-1625-1B	(25)	XF3M-2525-1B	(35)	XF3M-3525-1B	
8	XF3M-0825-1B	(17)	XF3M-1725-1B	26	XF3M-2625-1B	(36)	XF3M-3625-1B	
9	XF3M-0925-1B	18	XF3M-1825-1B	(28)	XF3M-2825-1B	(37)	XF3M-3725-1B	
10	XF3M-1025-1B	(19)	XF3M-1925-1B	(29)	XF3M-2925-1B	(38)	XF3M-3825-1B	
(11)	XF3M-1125-1B	20	XF3M-2025-1B	(30)	XF3M-3025-1B	40	XF3M-4025-1B	
12	XF3M-1225-1B	(21)	XF3M-2125-1B	(31)	XF3M-3125-1B			

100pcs per reel

Pins ^{*1}	Model	Pins ^{*1}	Model	Pins ^{*1}	Model	Pins ^{*1}	Model	Quantity per reel (unit) ^{*2}
(4)	XF3M-0425-1B-R100	(13)	XF3M-1325-1B-R100	(22)	XF3M-2225-1B-R100	(32)	XF3M-3225-1B-R100	100
(5)	XF3M-0525-1B-R100	(14)	XF3M-1425-1B-R100	(23)	XF3M-2325-1B-R100	(33)	XF3M-3325-1B-R100	
(6)	XF3M-0625-1B-R100	(15)	XF3M-1525-1B-R100	(24)	XF3M-2425-1B-R100	(34)	XF3M-3425-1B-R100	
(7)	XF3M-0725-1B-R100	(16)	XF3M-1625-1B-R100	(25)	XF3M-2525-1B-R100	(35)	XF3M-3525-1B-R100	
(8)	XF3M-0825-1B-R100	(17)	XF3M-1725-1B-R100	(26)	XF3M-2625-1B-R100	(36)	XF3M-3625-1B-R100	
(9)	XF3M-0925-1B-R100	18	XF3M-1825-1B-R100	(28)	XF3M-2825-1B-R100	(37)	XF3M-3725-1B-R100	
(10)	XF3M-1025-1B-R100	(19)	XF3M-1925-1B-R100	(29)	XF3M-2925-1B-R100	(38)	XF3M-3825-1B-R100	
(11)	XF3M-1125-1B-R100	(20)	XF3M-2025-1B-R100	(30)	XF3M-3025-1B-R100	(40)	XF3M-4025-1B-R100	
(12)	XF3M-1225-1B-R100	(21)	XF3M-2125-1B-R100	(31)	XF3M-3125-1B-R100			

*1. Please consult your OMRON representative for available pin count.
Please consult your OMRON representative for the marketing dates for pin counts in parentheses.
*2. Please order by integer multiple of the quantity per reel.

XF3M Rotary Backlock Connector (0.5-mm Pitch, 1.0-mm Pitch, Dual sided, Upper sided Contact)

XF3M(1) 1.0-mm pitch model

■ Dimensions

(Unit: mm)

XF3M(1)-□□15-1B
XF3M(1)-□□15-1D

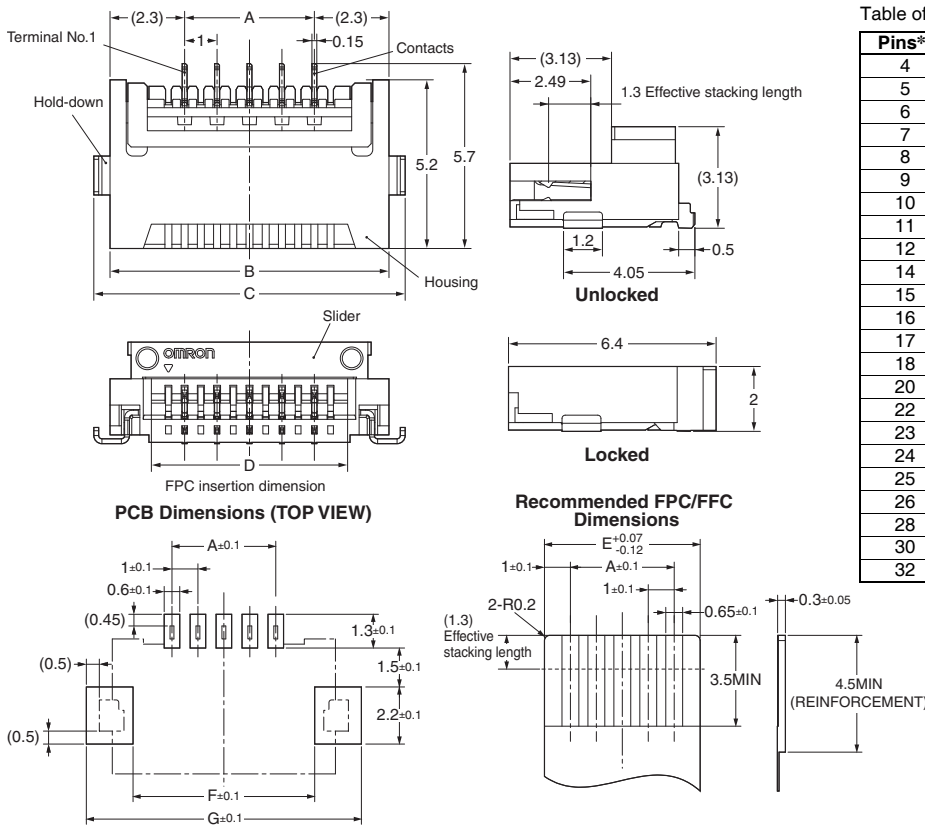

Table of Dimensions

Pins*1	A	B	C	D	E	F	G
4	3.0	7.6	8.6	5.05	5.0	6.0	9.6
5	4.0	8.6	9.6	6.05	6.0	7.0	10.6
6	5.0	9.6	10.6	7.05	7.0	8.0	11.6
7	6.0	10.6	11.6	8.05	8.0	9.0	12.6
8	7.0	11.6	12.6	9.05	9.0	10.0	13.6
9	8.0	12.6	13.6	10.05	10.0	11.0	14.6
10	9.0	13.6	14.6	11.05	11.0	12.0	15.6
11	10.0	14.6	15.6	12.05	12.0	13.0	16.6
12	11.0	15.6	16.6	13.05	13.0	14.0	17.6
14	13.0	17.6	18.6	15.05	15.0	16.0	19.6
15	14.0	18.6	19.6	16.05	16.0	17.0	20.6
16	15.0	19.6	20.6	17.05	17.0	18.0	21.6
17	16.0	20.6	21.6	18.05	18.0	19.0	22.6
18	17.0	21.6	22.6	19.05	19.0	20.0	23.6
20	19.0	23.6	24.6	21.05	21.0	22.0	25.6
22	21.0	25.6	26.6	23.05	23.0	24.0	27.6
23	22.0	26.6	27.6	24.05	24.0	25.0	28.6
24	23.0	27.6	28.6	25.05	25.0	26.0	29.6
25	24.0	28.6	29.6	26.05	26.0	27.0	30.6
26	25.0	29.6	30.6	27.05	27.0	28.0	31.6
28	27.0	31.6	32.6	29.05	29.0	30.0	33.6
30	29.0	33.6	34.6	31.05	31.0	32.0	35.6
32	31.0	35.6	36.6	33.05	33.0	34.0	37.6

■ Ordering Information

● Dual-sided Contact Models - Gold-plated (flash)

1500pcs per reel

Pins*1	Model	Pins*1	Model	Pins*1	Model	Pins*1	Model	Quantity per reel (unit)*2
4	XF3M(1)-0415-1B	10	XF3M(1)-1015-1B	(17)	XF3M(1)-1715-1B	25	XF3M(1)-2515-1B	1,500
5	XF3M(1)-0515-1B	11	XF3M(1)-1115-1B	18	XF3M(1)-1815-1B	26	XF3M(1)-2615-1B	
6	XF3M(1)-0615-1B	12	XF3M(1)-1215-1B	20	XF3M(1)-2015-1B	28	XF3M(1)-2815-1B	
7	XF3M(1)-0715-1B	14	XF3M(1)-1415-1B	22	XF3M(1)-2215-1B	30	XF3M(1)-3015-1B	
8	XF3M(1)-0815-1B	15	XF3M(1)-1515-1B	23	XF3M(1)-2315-1B	32	XF3M(1)-3215-1B	
9	XF3M(1)-0915-1B	16	XF3M(1)-1615-1B	(24)	XF3M(1)-2415-1B			

100pcs per reel

Pins*1	Model	Pins*1	Model	Pins*1	Model	Pins*1	Model	Quantity per reel (unit)*2
4	XF3M(1)-0415-1B-R100	10	XF3M(1)-1015-1B-R100	(17)	XF3M(1)-1715-1B-R100	(25)	XF3M(1)-2515-1B-R100	100
5	XF3M(1)-0515-1B-R100	11	XF3M(1)-1115-1B-R100	18	XF3M(1)-1815-1B-R100	26	XF3M(1)-2615-1B-R100	
6	XF3M(1)-0615-1B-R100	12	XF3M(1)-1215-1B-R100	20	XF3M(1)-2015-1B-R100	(28)	XF3M(1)-2815-1B-R100	
7	XF3M(1)-0715-1B-R100	14	XF3M(1)-1415-1B-R100	22	XF3M(1)-2215-1B-R100	30	XF3M(1)-3015-1B-R100	
8	XF3M(1)-0815-1B-R100	15	XF3M(1)-1515-1B-R100	23	XF3M(1)-2315-1B-R100	(32)	XF3M(1)-3215-1B-R100	
9	XF3M(1)-0915-1B-R100	16	XF3M(1)-1615-1B-R100	(24)	XF3M(1)-2415-1B-R100			

● Dual-sided Contact Models - Tin-plated

1500pcs per reel

Pins*1	Model	Pins*1	Model	Pins*1	Model	Pins*1	Model	Quantity per reel (unit)*2
(4)	XF3M(1)-0415-1D	10	XF3M(1)-1015-1D	(17)	XF3M(1)-1715-1D	(25)	XF3M(1)-2515-1D	1,500
(5)	XF3M(1)-0515-1D	(11)	XF3M(1)-1115-1D	18	XF3M(1)-1815-1D	(26)	XF3M(1)-2615-1D	
(6)	XF3M(1)-0615-1D	12	XF3M(1)-1215-1D	20	XF3M(1)-2015-1D	(28)	XF3M(1)-2815-1D	
(7)	XF3M(1)-0715-1D	(14)	XF3M(1)-1415-1D	22	XF3M(1)-2215-1D	(30)	XF3M(1)-3015-1D	
(8)	XF3M(1)-0815-1D	(15)	XF3M(1)-1515-1D	(23)	XF3M(1)-2315-1D	(32)	XF3M(1)-3215-1D	
(9)	XF3M(1)-0915-1D	(16)	XF3M(1)-1615-1D	(24)	XF3M(1)-2415-1D			

100pcs per reel

Pins*1	Model	Pins*1	Model	Pins*1	Model	Pins*1	Model	Quantity per reel (unit)*2
(4)	XF3M(1)-0415-1D-R100	10	XF3M(1)-1015-1D-R100	(17)	XF3M(1)-1715-1D-R100	(25)	XF3M(1)-2515-1D-R100	100
(5)	XF3M(1)-0515-1D-R100	(11)	XF3M(1)-1115-1D-R100	(18)	XF3M(1)-1815-1D-R100	(26)	XF3M(1)-2615-1D-R100	
(6)	XF3M(1)-0615-1D-R100	(12)	XF3M(1)-1215-1D-R100	(20)	XF3M(1)-2015-1D-R100	(28)	XF3M(1)-2815-1D-R100	
(7)	XF3M(1)-0715-1D-R100	(14)	XF3M(1)-1415-1D-R100	(22)	XF3M(1)-2215-1D-R100	(30)	XF3M(1)-3015-1D-R100	
(8)	XF3M(1)-0815-1D-R100	(15)	XF3M(1)-1515-1D-R100	(23)	XF3M(1)-2315-1D-R100	(32)	XF3M(1)-3215-1D-R100	
(9)	XF3M(1)-0915-1D-R100	(16)	XF3M(1)-1615-1D-R100	(24)	XF3M(1)-2415-1D-R100			

*1. Please consult your OMRON representative for available pin count.
Please consult your OMRON representative for the marketing dates for pin counts in parentheses.
*2. Please order by integer multiple of the quantity per reel.

XF2M

Rotary Backlock Connector (0.5-mm Pitch, Dual-sided Contact)

For FPC/FFC

Rotary Backlock Connectors Provide High-reliability and Superior Work Efficiency.

- Dual-sided contact reduces the number of parts.
- Applicable FPC/FFC thickness of 0.3 mm (Gold-plated type).
- Halogen Free (*)

* OMRON uses the following standard to determine halogen-free construction: 900 ppm max. for Br, 900 ppm max. for Cl, and 1,500 ppm max. for Br+Cl.

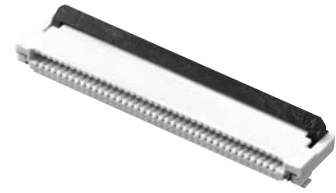

RoHS compliant

■ Ratings and Specifications

Rated current	0.5 A AC/DC
Rated voltage	50 V AC/DC
Contact resistance	50 mΩ max. (at 20 mV DC max., 100 mA max.)
Insulation resistance	100 MΩ min. (at 250 V DC)
Dielectric strength	250 V AC for 1 min. (leakage current: 1 mA max.)
Insertion durability	20 times
Ambient operating temperature	-30 to 85 °C (With no icing or condensation)

■ Materials and Finish

Housing	LCP resin (UL94 V-0)/natural
Slider	LCP resin (UL94 V-0)/black
Contacts	Spring copper alloy/nickel substrate (2 μm) Gold-plated contacts (0.15 μm)
Hold-down	Copper alloy/tin-plated (1.5 μm)

■ Dimensions

(Unit: mm)

XF2M-□□15-1A
XF2M-□□15-1AH

Table of Dimensions

Pins*1	Model	A	B	C	D	E	F	G
6	XF2M-0615-1A	2.5	3.6	6.5	7.1	5.1	4.1	7.5
8	XF2M-0815-1A	3.5	4.6	7.5	8.1	6.1	5.1	8.5
10	XF2M-1015-1A	4.5	5.6	8.5	9.1	7.1	6.1	9.5
12	XF2M-1215-1A	5.5	6.6	9.5	10.1	8.1	7.1	10.5
14	XF2M-1415-1A	6.5	7.6	10.5	11.1	9.1	8.1	11.5
18	XF2M-1815-1A	8.5	9.6	12.5	13.1	11.1	10.1	13.5
20	XF2M-2015-1A	9.5	10.6	13.5	14.1	12.1	11.1	14.5
22	XF2M-2215-1A	10.5	11.6	14.5	15.1	13.1	12.1	15.5
24	XF2M-2415-1A	11.5	12.6	15.5	16.1	14.1	13.1	16.5
26	XF2M-2615-1A	12.5	13.6	16.5	17.1	15.1	14.1	17.5
30	XF2M-3015-1A	14.5	15.6	18.5	19.1	17.1	16.1	19.5
32	XF2M-3215-1A	15.5	16.6	19.5	20.1	18.1	17.1	20.5
33	XF2M-3315-1A	16.0	17.1	20.0	20.6	18.6	17.6	21.0
34	XF2M-3415-1A	16.5	17.6	20.5	21.1	19.1	18.1	21.5
35	XF2M-3515-1A	17.0	18.1	21.0	21.6	19.6	18.6	22.0
36	XF2M-3615-1A	17.5	18.6	21.5	22.1	20.1	19.1	22.5
38	XF2M-3815-1A	18.5	19.6	22.5	23.1	21.1	20.1	23.5
40	XF2M-4015-1A	19.5	20.6	23.5	24.1	22.1	21.1	24.5
42	XF2M-4215-1A	20.5	21.6	24.5	25.1	23.1	22.1	25.5
45	XF2M-4515-1A	22.0	23.1	26.0	26.6	24.6	23.6	27.0
50	XF2M-5015-1A	24.5	25.6	28.5	29.1	27.1	26.1	29.5
54	XF2M-5415-1AH	26.5	27.6	30.5	31.1	29.1	28.1	31.5
55	XF2M-5515-1AH	27.0	28.1	31.0	31.6	29.6	28.6	32.0
60	XF2M-6015-1AH	29.5	30.6	33.5	34.1	32.1	31.1	34.5

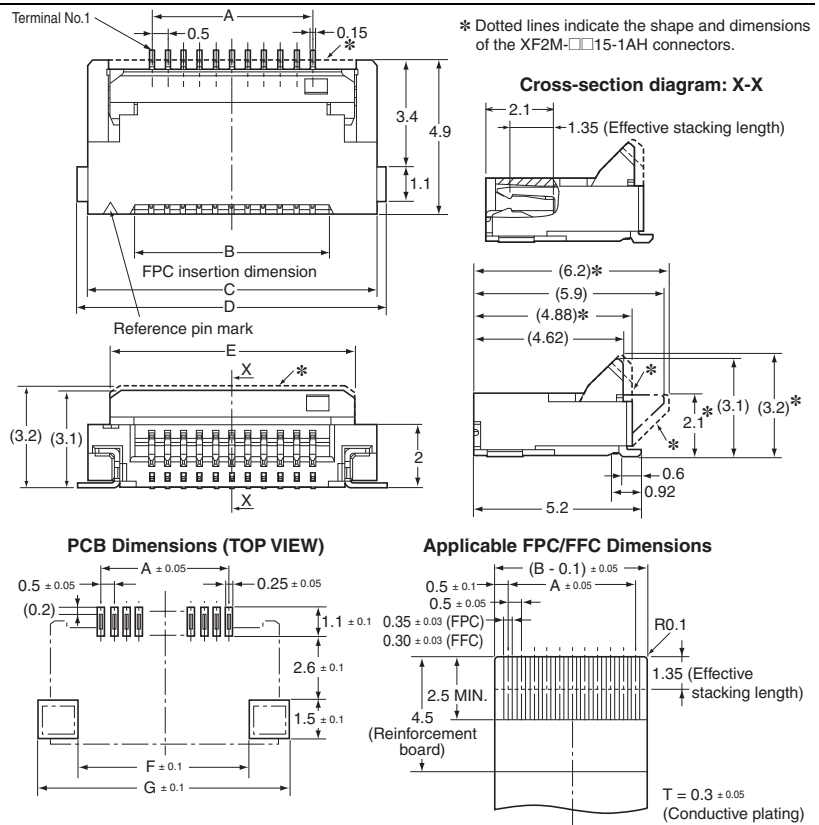

■ Ordering Information

1500pcs per reel

Pins*1	Model	Pins*1	Model	Pins*1	Model	Pins*1	Model	Quantity per reel (unit) *2
6	XF2M-0615-1A	22	XF2M-2215-1A	35	XF2M-3515-1A	54	XF2M-5415-1AH	1,500
8	XF2M-0815-1A	24	XF2M-2415-1A	36	XF2M-3615-1A	55	XF2M-5515-1AH	
10	XF2M-1015-1A	26	XF2M-2615-1A	38	XF2M-3815-1A	60	XF2M-6015-1AH	
12	XF2M-1215-1A	30	XF2M-3015-1A	40	XF2M-4015-1A			
14	XF2M-1415-1A	32	XF2M-3215-1A	42	XF2M-4215-1A			
18	XF2M-1815-1A	33	XF2M-3315-1A	45	XF2M-4515-1A			
20	XF2M-2015-1A	34	XF2M-3415-1A	50	XF2M-5015-1A			

100pcs per reel

Pins*1	Model	Pins*1	Model	Pins*1	Model	Pins*1	Model	Quantity per reel (unit) *2
6	XF2M-0615-1A-R100	22	XF2M-2215-1A-R100	35	XF2M-3515-1A-R100	54	XF2M-5415-1AH-R100	100
8	XF2M-0815-1A-R100	24	XF2M-2415-1A-R100	36	XF2M-3615-1A-R100	55	XF2M-5515-1AH-R100	
10	XF2M-1015-1A-R100	26	XF2M-2615-1A-R100	38	XF2M-3815-1A-R100	60	XF2M-6015-1AH-R100	
12	XF2M-1215-1A-R100	30	XF2M-3015-1A-R100	40	XF2M-4015-1A-R100			
14	XF2M-1415-1A-R100	32	XF2M-3215-1A-R100	42	XF2M-4215-1A-R100			
18	XF2M-1815-1A-R100	33	XF2M-3315-1A-R100	45	XF2M-4515-1A-R100			
20	XF2M-2015-1A-R100	34	XF2M-3415-1A-R100	50	XF2M-5015-1A-R100			

*1. Please consult your OMRON representative for available pin count.

*2. Please order by integer multiple of the quantity per reel.

Greater Freedom in Board Design with a Bottom Wall and the Smallest On-board Area in the Industry

- Smallest on-board area and volume in the industry.
- Low on-board height of only 1.2 mm.
- Highest board design surface efficiency in the industry with a bottom wall preventing terminal exposure.
- Construction with secure slider locking mechanism.
- Applicable FPC thickness of 0.3 mm (Gold-plated type).
- Halogen Free (*)



* OMRON uses the following standard to determine halogen-free construction: 900 ppm max. for Br, 900 ppm max. for Cl, and 1,500 ppm max. for Br+Cl.

RoHS compliant

■ Ratings and Specifications

Rated current	0.5 A AC/DC
Rated voltage	50 V AC/DC
Contact resistance	30 mΩ max. (at 20 mV DC max., 100 mA max.)
Insulation resistance	100 MΩ min. (at 250 V DC)
Dielectric strength	250 V AC for 1 min. (leakage current: 1 mA max.)
Insertion durability	20 times
Ambient operating temperature	-30 to 85 °C (With no icing or condensation)

■ Materials and Finish

Item	Model	XF2L (Upper-sided Models)	XF2L (Lower-sided Models)
Housing		LCP resin (UL94 V-0)/natural	
Slider		LCP resin (UL94 V-0)/black	LCP resin (UL94 V-0)/brown
Contacts		Spring copper alloy/nickel substrate (2 μm) Gold-plated contacts (0.15 μm)	
Hold-down		Copper alloy/tin-plated (1.5 μm)	

■ Dimensions

(Unit: mm)

XF2L-□□□5-1A

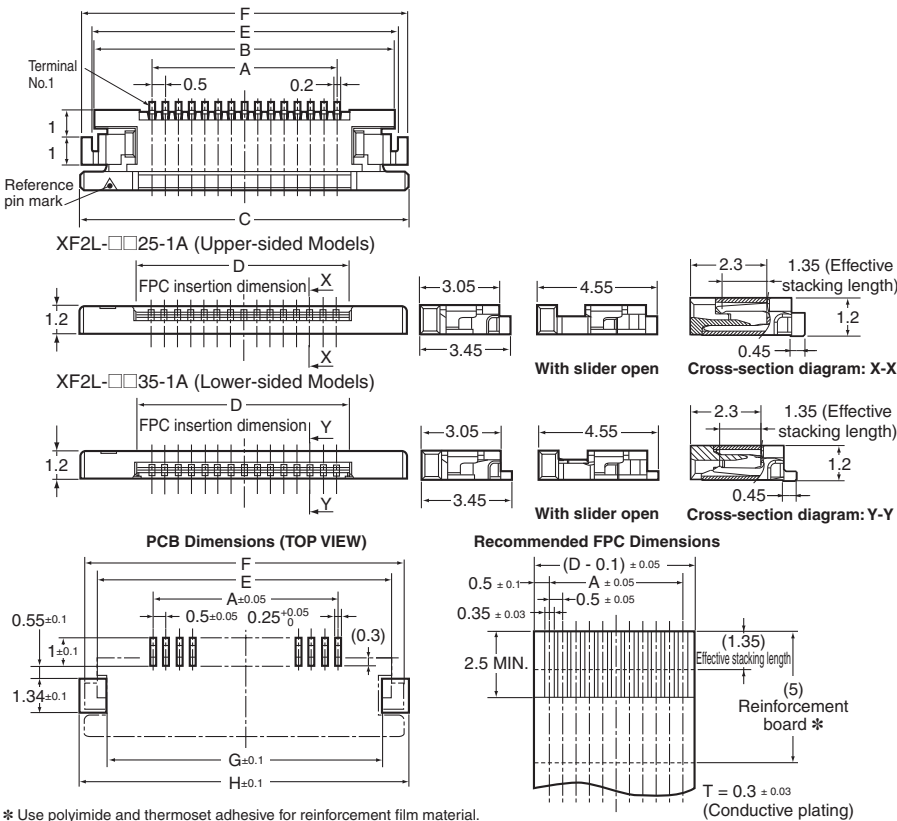

Table of Dimensions

Upper sided

Pins ^{*1}	Model	A	B	C	D	E	F	G	H
4	XF2L-0425-1A	1.5	5.9	6.9	2.6	5.88	6.88	5.28	7.28
6	XF2L-0625-1A	2.5	6.9	7.9	3.6	6.88	7.88	6.28	8.28
7	XF2L-0725-1A	3.0	7.4	8.4	4.1	7.38	8.38	6.78	8.78
8	XF2L-0825-1A	3.5	7.9	8.9	4.6	7.88	8.88	7.28	9.28
9	XF2L-0925-1A	4.0	8.4	9.4	5.1	8.38	9.38	7.78	9.78
10	XF2L-1025-1A	4.5	8.9	9.9	5.6	8.88	9.88	8.28	10.28
12	XF2L-1225-1A	5.5	9.9	10.9	6.6	9.88	10.88	9.28	11.28
13	XF2L-1325-1A	6.0	10.4	11.4	7.1	10.38	11.38	9.78	11.78
18	XF2L-1825-1A	8.5	12.9	13.9	9.6	12.88	13.88	12.28	14.28
21	XF2L-2125-1A	10.0	14.4	15.4	11.1	14.38	15.38	13.78	15.78
26	XF2L-2625-1A	12.5	16.9	17.9	13.6	16.88	17.88	16.28	18.28
30	XF2L-3025-1A	14.5	18.9	19.9	15.6	18.88	19.88	18.28	20.28

Lower sided

Pins ^{*1}	Model	A	B	C	D	E	F	G	H
5	XF2L-0535-1A	2.0	6.4	7.4	3.1	6.38	7.38	5.78	7.78
6	XF2L-0635-1A	2.5	6.9	7.9	3.6	6.88	7.88	6.28	8.28
7	XF2L-0735-1A	3.0	7.4	8.4	4.1	7.38	8.38	6.78	8.78
8	XF2L-0835-1A	3.5	7.9	8.9	4.6	7.88	8.88	7.28	9.28
10	XF2L-1035-1A	4.5	8.9	9.9	5.6	8.88	9.88	8.28	10.28
12	XF2L-1235-1A	5.5	9.9	10.9	6.6	9.88	10.88	9.28	11.28
13	XF2L-1335-1A	6.0	10.4	11.4	7.1	10.38	11.38	9.78	11.78
15	XF2L-1535-1A	7.0	11.4	12.4	8.1	11.38	12.38	10.78	12.78
18	XF2L-1835-1A	8.5	12.9	13.9	9.6	12.88	13.88	12.28	14.28
19	XF2L-1935-1A	9.0	13.4	14.4	10.1	13.38	14.38	12.78	14.78
20	XF2L-2035-1A	9.5	13.9	14.9	10.6	13.88	14.88	13.28	15.28
22	XF2L-2235-1A	10.5	14.9	15.9	11.6	14.88	15.88	14.28	16.28
24	XF2L-2435-1A	11.5	15.9	16.9	12.6	15.88	16.88	15.28	17.28
30	XF2L-3035-1A	14.5	18.9	19.9	15.6	18.88	19.88	18.28	20.28

* Use polyimide and thermoset adhesive for reinforcement film material.

■ Ordering Information

Pins ^{*1}	List of Models	Model	Pins ^{*1}	List of Models	Model	Pins ^{*1}	List of Models	Model	Quantity per reel (unit) ^{*2}
4	Upper sided	XF2L-0425-1A	10	Upper sided	XF2L-1025-1A	19	Lower sided	XF2L-1935-1A	3,000
5	Lower sided	XF2L-0535-1A		Lower sided	XF2L-1035-1A	20	Lower sided	XF2L-2035-1A	
6	Upper sided	XF2L-0625-1A	12	Upper sided	XF2L-1225-1A	21	Upper sided	XF2L-2125-1A	
	Lower sided	XF2L-0635-1A		Lower sided	XF2L-1235-1A	22	Lower sided	XF2L-2235-1A	
7	Upper sided	XF2L-0725-1A	13	Upper sided	XF2L-1325-1A	24	Lower sided	XF2L-2435-1A	
	Lower sided	XF2L-0735-1A		Lower sided	XF2L-1335-1A	26	Upper sided	XF2L-2625-1A	
8	Upper sided	XF2L-0825-1A	15	Lower sided	XF2L-1535-1A	30	Upper sided	XF2L-3025-1A	
	Lower sided	XF2L-0835-1A		Upper sided	XF2L-1825-1A		Lower sided	XF2L-3035-1A	
9	Upper sided	XF2L-0925-1A	18	Lower sided	XF2L-1835-1A	-	-	-	

*1. Please consult your OMRON representative for available pin count.

*2. Please order by integer multiple of the quantity per reel.

XF2J

ZIF Slide-locking Connector (0.5-mm Pitch)

For FPC/FFC

Top-entry ZIF Connector.

- Low on-board height of only 4.15 mm.
- Correspond for auto-mounting, secured the pick-and-place on top of the connector.
- Models with reverse terminal type also available.
- Applicable FPC/FFC thickness of 0.3 mm (Gold-plated type).

RoHS compliant

■ Ratings and Specifications

Rated current	0.5 A AC/DC
Rated voltage	50 V AC/DC
Contact resistance	30 mΩ max. (at 20 mV DC max., 100 mA max.)
Insulation resistance	100 MΩ min. (at 250 V DC)
Dielectric strength	250 V AC for 1 min. (leakage current: 1 mA max.)
Insertion durability	30 times
Ambient operating temperature	-30 to 85 °C (With no icing or condensation)

■ Materials and Finish

Housing	PA46 resin (UL94 V-0)/natural
Slider	LCP resin (UL94 V-0)/black
Contacts	Spring copper alloy/nickel substrate (2 μm), Gold-plated contacts (0.15 μm)
Hold-down	Copper alloy/tin-plated (1.5 μm)



■ Dimensions

(Unit: mm)

XF2J-□□24-1□A

Recommended FPC/FFC Dimensions

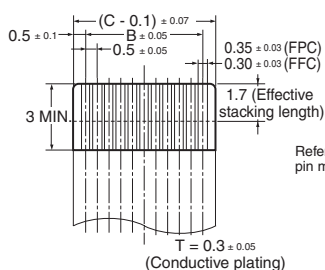

(Standard terminal type)

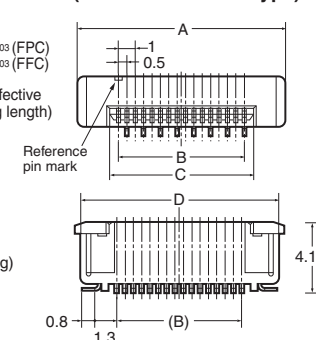

(Reverse terminal type)

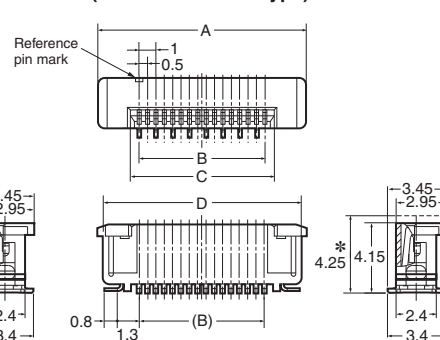
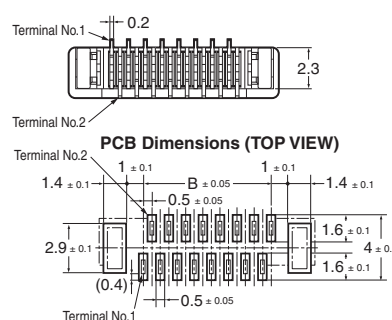
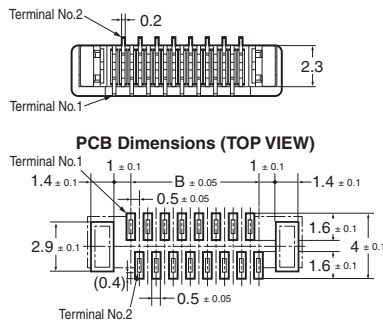

Table of Dimensions

Pins #1	Model		A	B	C	D
	Standard terminal type	Reverse terminal type				
6	XF2J-0624-11A	XF2J-0624-12A	7.5	2.5	3.6	6.9
8	XF2J-0824-11A	XF2J-0824-12A	8.5	3.5	4.6	7.9
10	XF2J-1024-11A	XF2J-1024-12A	9.5	4.5	5.6	8.9
12	XF2J-1224-11A	XF2J-1224-12A	10.5	5.5	6.6	9.9
14	XF2J-1424-11A	-	11.5	6.5	7.6	10.9
16	XF2J-1624-11A	XF2J-1624-12A	12.5	7.5	8.6	11.9
18	XF2J-1824-11A	XF2J-1824-12A	13.5	8.5	9.6	12.9
20	XF2J-2024-11A	XF2J-2024-12A	14.5	9.5	10.6	13.9
22	XF2J-2224-11A	XF2J-2224-12A	15.5	10.5	11.6	14.9
24	XF2J-2424-11A	XF2J-2424-12A	16.5	11.5	12.6	15.9
26	XF2J-2624-11A	-	17.5	12.5	13.6	16.9
28	XF2J-2824-11A	-	18.5	13.5	14.6	17.9
30	XF2J-3024-11A	-	19.5	14.5	15.6	18.9
40	-	XF2J-4024-12A	25.1	19.5	20.6	24.3



* Dotted lines indicate the shape and dimensions of the XF2J-4024-12A connectors.

■ Ordering Information

1000pcs per reel

Pins ^{*1}	Model		Pins ^{*1}	Model		Pins ^{*1}	Model		Quantity per reel (unit) ^{*2}
	Standard terminal type	Reverse terminal type		Standard terminal type	Reverse terminal type		Standard terminal type	Reverse terminal type	
6	XF2J-0624-11A	XF2J-0624-12A	16	XF2J-1624-11A	XF2J-1624-12A	26	XF2J-2624-11A	-	1,000
8	XF2J-0824-11A	XF2J-0824-12A	18	XF2J-1824-11A	XF2J-1824-12A	28	XF2J-2824-11A	-	
10	XF2J-1024-11A	XF2J-1024-12A	20	XF2J-2024-11A	XF2J-2024-12A	30	XF2J-3024-11A	-	
12	XF2J-1224-11A	XF2J-1224-12A	22	XF2J-2224-11A	XF2J-2224-12A	40	-	XF2J-4024-12A	
14	XF2J-1424-11A	-	24	XF2J-2424-11A	XF2J-2424-12A				

100pcs per reel

Pins ^{*1}	Model		Pins ^{*1}	Model		Pins ^{*1}	Model		Quantity per reel (unit) ^{*2}
	Standard terminal type	Reverse terminal type		Standard terminal type	Reverse terminal type		Standard terminal type	Reverse terminal type	
6	XF2J-0624-11A-R100	XF2J-0624-12A-R100	16	XF2J-1624-11A-R100	XF2J-1624-12A-R100	26	XF2J-2624-11A-R100	-	100
8	XF2J-0824-11A-R100	XF2J-0824-12A-R100	18	XF2J-1824-11A-R100	XF2J-1824-12A-R100	28	XF2J-2824-11A-R100	-	
10	XF2J-1024-11A-R100	XF2J-1024-12A-R100	20	XF2J-2024-11A-R100	XF2J-2024-12A-R100	30	XF2J-3024-11A-R100	-	
12	XF2J-1224-11A-R100	XF2J-1224-12A-R100	22	XF2J-2224-11A-R100	XF2J-2224-12A-R100	40	-	XF2J-4024-12A-R100	
14	XF2J-1424-11A-R100	-	24	XF2J-2424-11A-R100	XF2J-2424-12A-R100				

*1. Please consult your OMRON representative for available pin count.

*2. Please order by integer multiple of the quantity per reel.

Common Precautions for XF Connectors

■ Safety Precautions

Precautions for Correct Use

For All Models

● For Operating

- Make sure that the FPC has been inserted correctly.
If the FPC is inserted incorrectly from the customer's design specification, the pin number will not match and it may damage the contacts or cause malfunction of the equipment.
- Insert the FPC fully to the back of the connector.
Not doing so may cause a loss of contact reliability.
- Do not lock or unlock the slider with excessive force.
The connector may be damaged, and cause contact failure.
- Do not use the connector of which the slider has once come off.
- When inserting and drawing out the FPC, make sure that the slider has been unlocked first.

Using the FPC in the following ways may damage the FPC, change the shape of the contacts, or result in contact failure.

- (1) Drawing out the FPC when the slider is still locked.
- (2) Drawing out the FPC by pulling it up and down or from left to right or twisting it sideways.

● For Designing

- When mounting the connector to the FPC, design the FPC so that extreme peel force should not be applied directly on to the connector.
If the FPC bends near the connector, or if the FPC is used with extreme peel force directly on to the connector, it may cause a contact loss.
- If the connector-mounted FPC is installed at a location or in any equipment that will subject the FPC to continuous shake or movement, secure the FPC or take any countermeasure against FPC disconnection from the connector.
- Use FPCs that conform to the appropriate specifications and size as stated or recommended by OMRON.
When using a different FPC, or an FFC, contact OMRON.
- Use the same metal for the FPC plating and the connector plating.
- “Whiskers” may protrude from the FPC film of some lead-free FPCs. Be careful when using these units.
- Ensure a metal mask thickness of $t = 0.12$ to 0.15 mm.
The recommended metal mask open area is 90% of the printed circuit board mating dimensions given in the dimensions diagrams.

● For Mounting

- Do not mount (reflow or manual soldering) the connector to PCB with FPC inserted in the connector. Doing so may result in contact failure.
- The reflow conditions are as stated in OMRON's specifications and guidelines.
These conditions, however, depend on the type of solder, the manufacturer, the amount of solder, the size of the circuit board, and the other mounting materials.
- When mounting the connector by manual soldering, observe the following precautions to ensure contact reliability.
 - (1) Conditions for manual soldering: $350 \pm 10^\circ\text{C}$ 3 ± 1 sec
 - (2) Do not apply an excessive amount of solder. Excessive solder will cause the flux to rise.
 - (3) Do not apply the soldering iron to the mount attachments using force. Doing so may cause the connectors to change shape.

- (4) Do not apply the soldering iron to any parts of the connector other than the mount attachments. Doing so may cause the connector to change shape.

- There are case that the following phenomenon is sometimes occurred. However there are no bad influences to functions and performance of the connector.

- (1) Occurrence of black spot to plastic parts
- (2) Occurrence of a weld line to plastic parts
- (3) Occurrence of the blister to the plastic parts
- (4) Occurrence of discoloration to plating parts of terminal and hold-down or plastic parts of slider after reflow.

● For Board Mounting

- Be careful of board warping. The connector flatness is 0.1 mm max. A large amount of warping, however, may result in soldering faults.
- Do not apply excessive force on the connector before mounting it. The connector may be damaged, resulting in faulty contacts. Do not insert the FPC and lock the slider before mounting the connector.
- Be careful not to apply an excessive load on the board when performing the following actions. The connector may be damaged, resulting in faulty contacts.
 - (1) Dividing multi-cavity boards.
 - (2) Securing a board with screws.

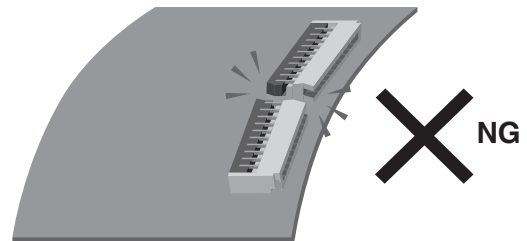

● Storage

- (1) Do not store the connectors in locations subject to dust or high humidity.
- (2) Do not store the connectors in locations close to sources of gasses such ammonia gas or sulfide gas.

For Slidelocking Models

● For Operating

- When locking the slider, apply pressure to both sides or the entire slider, then push the slider all the way in.
Not doing so may result in contact failure.

● For Designing

- When designing the board, be sure to allow unlocking and operating space for the slider.

- XF2J, XF2M, XF2W and XF3M series are available to use FFC cable.
Please check any condition of each cable in spec sheet, or contact with our Sales side.

Operating the XF Rotary Backlock

FPC connector parts

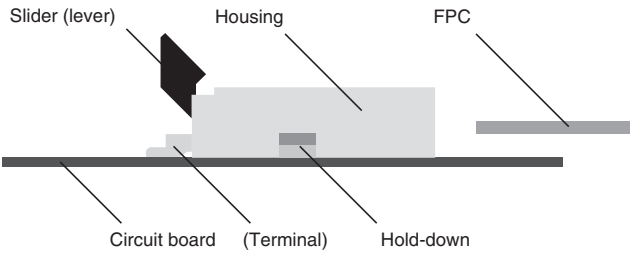

Handling Methods

• For Inserting the FPC

(1) Insert the FPC fully to the back of the connector.

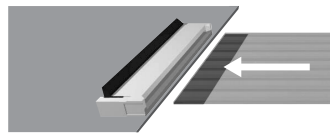

The slider (lever) shown open

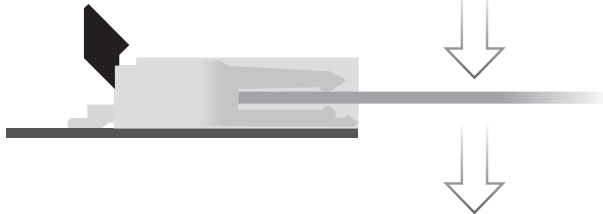

(2) Activate the slider (lever) and lock the FPC in place.

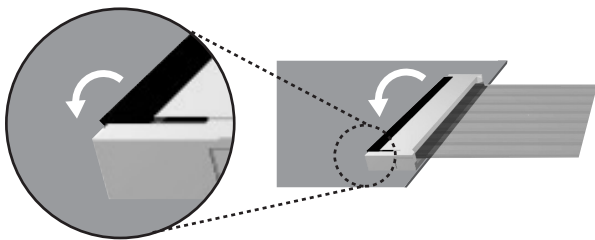

The slider (lever) shown locked

(1) Move the slider (lever) upwards to disengage the locking mechanism.

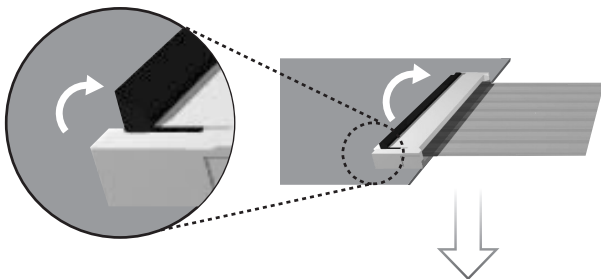

(2) Once the lock has been disengaged, pull the FPC out.

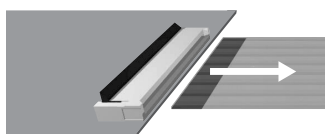

Precautions during Use

• For Operating

(1) Do not lock the slider (lever) without an FPC inserted. Locking the slider (lever) without an FPC inserted will increase the force required to insert an FPC.

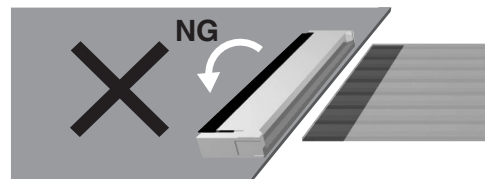
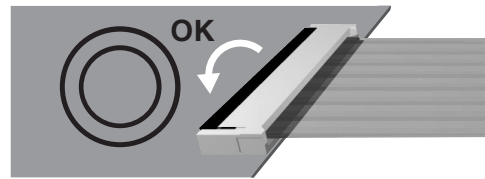

(2) Do not lock or unlock the slider (lever) with excessive force. The connector may be damaged, resulting in faulty contacts. Do not use the slider (lever) again if it becomes detached.

(3) When locking the slider (lever), apply pressure with your fingertips to both sides of the slider (lever) and then twist the slider (lever) until it comes away from the unit. Failing to lock the slider (lever) properly may result in contact failure.

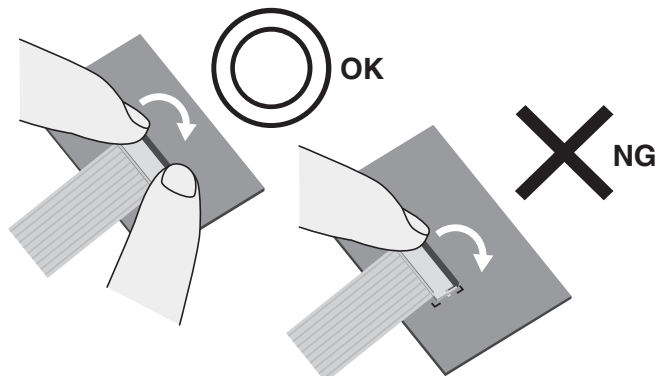

Do not apply force horizontally to the PCB when locking the slider (lever).

The connector may be damaged, resulting in faulty contacts.

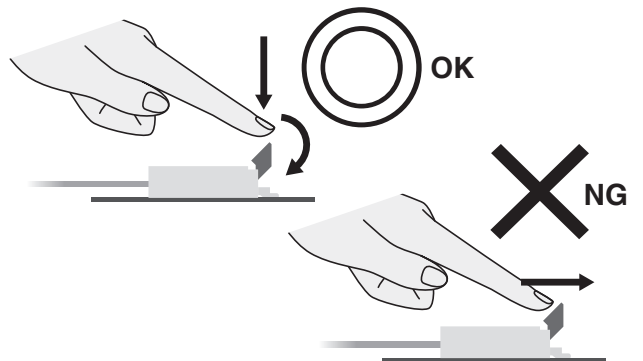

Operating the XF Rotary Backlock

(4) When unlocking the slider (lever), place your fingers on either side or the entire slider (lever) and slowly lift the slider (lever) up and away.

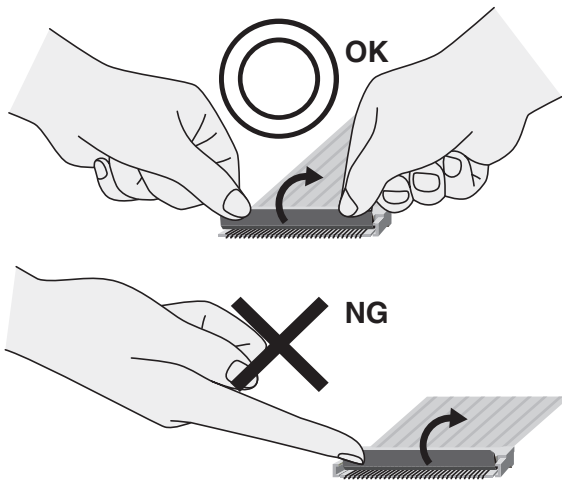

Do not engage the slider past its initial location during the unlocking process.

The connector may be damaged, resulting in faulty contacts.

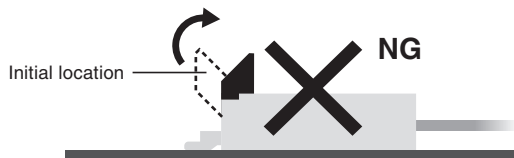

Performing the following action may cause the terminals to change shape or otherwise cause contact failures.

• Using tweezers to unlock the slider (lever).

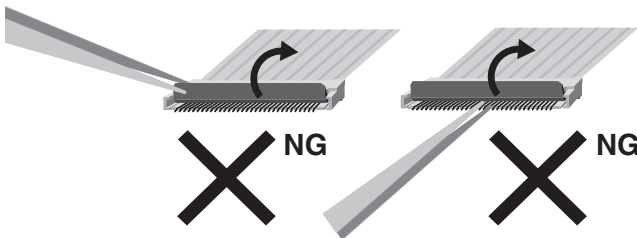

(5) When inserting and drawing out the FPC, be sure to check that the slider (lever) has been unlocked first.

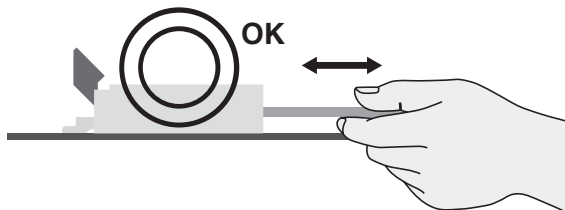

Using the FPC in the following ways may damage the FPC, change the shape of the contacts, or result in contact failure.

• Drawing out the FPC when the slider (lever) is still locked.

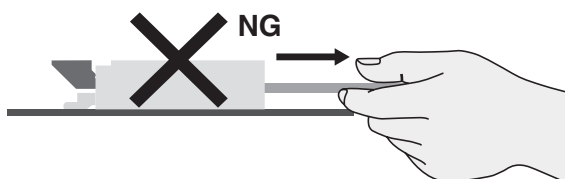

• Drawing out the FPC by pulling it up and down or from left to right or twisting it sideways.

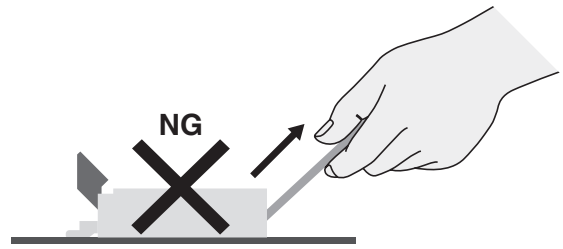

(6) Make sure that the FPC has been inserted correctly.

If the FPC is inserted incorrectly from the customer's design specification, the pin number will not match and it may damage the contacts or cause malfunction of the equipment.

• For Mounting

- (1) Do not perform reflow or manual soldering with the FPC inserted in the connector and the slider (lever) in the locked position. Doing so may result in contact failure.
- (2) The reflow conditions are as stated in OMRON's specifications and guidelines. These conditions, however, depend on the type of solder, the manufacturer, the amount of solder, the size of the circuit board, and the other mounting materials.

• For Designing

- (1) Design the FPC so that extreme peel force should not be applied directly on to the connector. If the FPC bends near the connector, or if the FPC is used with extreme peel force directly on to the connector, it may cause a contact loss.
- (2) If the FPC is installed at a location or in any equipment that will subject the FPC to continuous shake or movement, secure the FPC.
- (3) Use FPCs that conform to the appropriate specifications and size as stated or recommended by OMRON. When using a different FPC, or an FFC, contact OMRON.
- (4) Use the same metal for the FPC plating and the connector plating.
- (5) "Whiskers" may protrude from the FPC film of some lead-free FPCs. Be careful when using these units.
- (6) When designing the board, be sure to allow locking and operating space for the slider (lever).

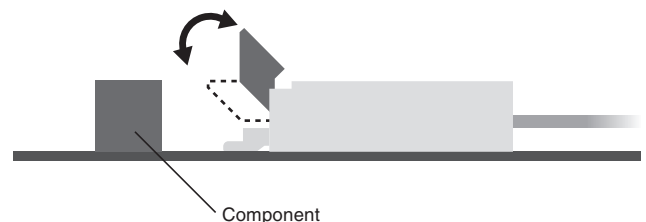

(7) Make sure that the metal mask thickness is within the appropriate specifications and size as stated by OMRON. The recommended metal mask open area is 90% of the printed circuit board mating dimensions given in the dimensions diagrams.

• XF2J, XF2M, XF2W and XF3M series are available to use FFC cable.

Please check any condition of each cable in spec sheet, or contact with our Sales side.

Operating the XF Rotary Frontlock

FPC connector parts

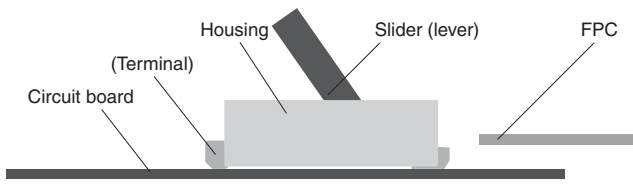

Handling Methods

● For Inserting the FPC

- (1) When unlocking the slider, use your fingernail to rotate and lift the slider.

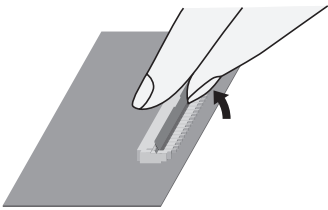

- (2) Securely insert the FPC so that it is perpendicular to the connector and horizontal to the connector.



- (3) When locking the slider, apply pressure with your fingertips to the center of the slider, then twist the slider until it comes away from the unit.

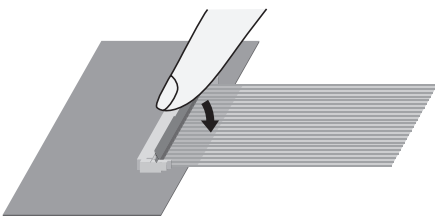

● For Drawing Out the FPC

- (1) Unlock the slider by pushing it up, then remove the FPC.

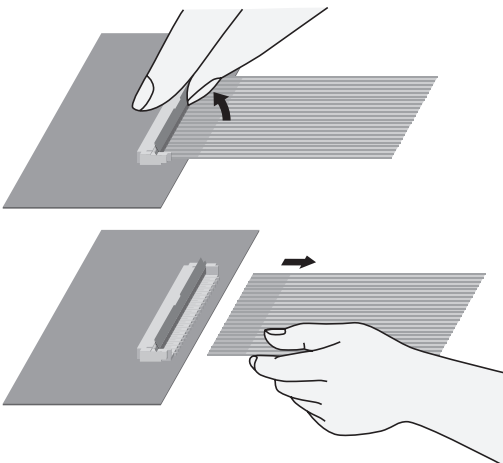

Precautions during Use

● For Operating

- (1) The slider mechanism rotates around a rotary shaft. Operate the slider in a rotating movement.

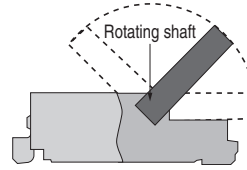

- (2) The slider cannot be opened to an angle of more than 125 degrees. Do not apply force on the slider beyond that point. The connector may be damaged, resulting in faulty contacts. Do not use the connector of which the slider has once come off.

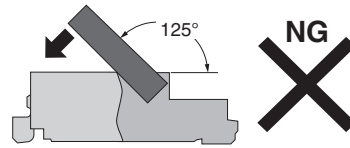

- (3) Lock and unlock the slider using the center of the slider. Using the end of the slider may result in incomplete locking, damage, or contact failure.

- (4) As shown in the following figure, do not touch the terminals with your fingernail or fingers if using the slider without the FPC inserted. Doing so may cause the terminals to change shape and result in contact failure.

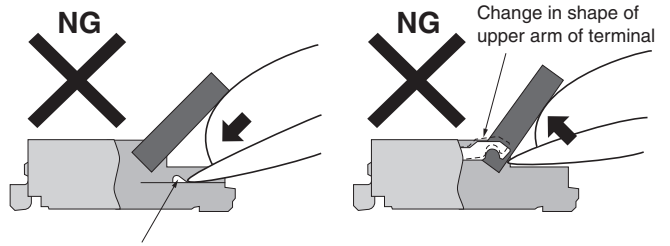

- (5) Using the FPC in the follow ways may damage the FPC, change the shape of the contacts, or result in contact failure.

- Drawing out the FPC when the slider (lever) is still locked.

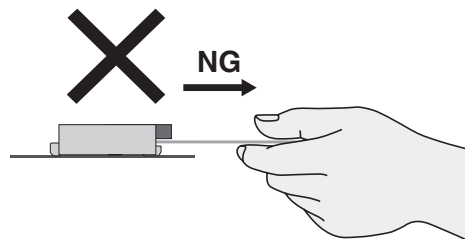

- Drawing out the FPC by pulling it up and down or from left to right or twisting it sideways.

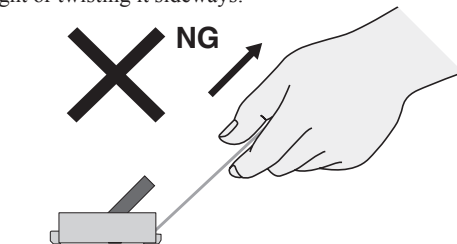

- (6) Make sure that the FPC has been inserted correctly. If the FPC is inserted incorrectly from the customer's design specification, the pin number will not match and it may damage the contacts or cause malfunction of the equipment.

● For Mounting

- (1) Do not perform reflow or manual soldering with the FPC inserted in the connector. Doing so may result in contact failure.
- (2) The reflow conditions are as stated in OMRON's specifications and guidelines. These conditions, however, depend on the type of solder, the manufacturer, the amount of solder, the size of the circuit board, and the other mounting materials.

● For Designing

- (1) Design the FPC so that extreme peel force should not be applied directly on to the connector. If the FPC bends near the connector, or if the FPC is used with extreme peel force directly on to the connector, it may cause a contact loss.
- (2) If the FPC is installed at a location or in any equipment that will subject the FPC to continuous shake or movement, secure the FPC.
- (3) Use FPCs that conform to the appropriate specifications and size as stated or recommended by OMRON. When using a different FPC, or an FFC, contact OMRON.
- (4) Use the same metal for the FPC plating and the connector plating.
- (5) "Whiskers" may protrude from the FPC film of some lead-free FPCs. Be careful when using these units.
- (6) Make sure that the metal mask thickness is within the appropriate specifications and size as stated by OMRON. The recommended metal mask open area is 90% of the printed circuit board mating dimensions given in the dimensions diagrams.

- Application examples provided in this document are for reference only. In actual applications, confirm equipment functions and safety before using the product.
- Consult your OMRON representative before using the product under conditions which are not described in the manual or applying the product to nuclear control systems, railroad systems, aviation systems, vehicles, combustion systems, medical equipment, amusement machines, safety equipment, and other systems or equipment that may have a serious influence on lives and property if used improperly. Make sure that the ratings and performance characteristics of the product provide a margin of safety for the system or equipment, and be sure to provide the system or equipment with double safety mechanisms.

Note: Do not use this document to operate the Unit.

X-ON Electronics

Largest Supplier of Electrical and Electronic Components

Click to view similar products for [FFC & FPC Connectors](#) category:

Click to view products by [Omron](#) manufacturer:

Other Similar products are found below :

[FPH-1422G](#) [FPH-1602G](#) [K-FC20](#) [FH29B-80S-0.2SHW\(99\)](#) [FPH-2022G](#) [AYF332735](#) [52610-1075](#) [52610-1275](#) [52610-1934](#) [501864-3091-TR225](#) [086222026001800](#) [52610-0675](#) [62684-36210E9ALF](#) [52746-1671-TR250](#) [10051922-2810EHLF](#) [6-520415-9](#) [SFV6R-1STE9HLF](#) [XF3M-2915-1B-R100](#) [1658549-1](#) [AYF534065TA](#) [AYF351525](#) [086212040340800+](#) [AYF530365TA](#) [67000-014LF](#) [67000-004LF](#) [006207341915000+](#) [DS1020-19RT1D](#) [67000-003LF](#) [67000-011LF](#) [67000-016LF](#) [HFW14R-2STE9LF](#) [SFV32R-2STBE9HLF](#) [SFW12R-5STE9LF](#) [SFW18R-1STAE9LF](#) [SFW4R-5STE9LF](#) [52807-0430](#) [046283021002868+](#) [THD1015-8CL-SN](#) [67000-006LF](#) [502250-8027](#) [104267-9617](#) [66987-011LF](#) [AYF362535](#) [F0501-T-50-20T-R](#) [F1003-ZV-12-25T-R](#) [HFW8S-2STAE1HLF](#) [67000-008LF](#) [67000-012LF](#) [ECC576069EU](#) [F1002-B-20-20T-R](#)