

Rotary Backlock Connectors Provide Improved Insertion of FPC/FFC Cables and helps Confirm Proper Connection with Sure Lock Feel.

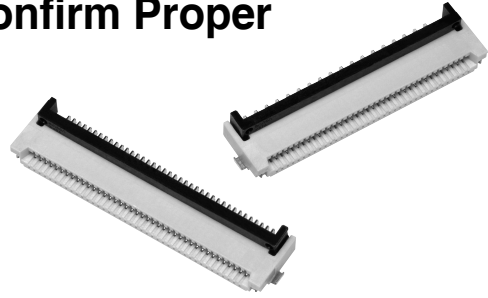

- Models available with 0.5-mm or 1.0-mm pitch.
- Models available with dual-sided contacts or upper sided. (Models with upper sided come only with a 0.5-mm pitch.)
- Models available with gold or Tin-plated. (Tin-plated is available only with models with dual-sided contacts.)
- Models with 80 pins (multiple type) available with 0.5-mm pitch.
- Applicable FPC/FFC thickness of 0.3 mm.
- Halogen Free (*)

* OMRON uses the following standard to determine halogen-free construction: 900 ppm max. for Br, 900 ppm max. for Cl, and 1,500 ppm max. for Br+Cl.

RoHS compliant

■ Ratings and Specifications

| | |
|-------------------------------|--|
| Rated current | 0.5 A AC/DC |
| Rated voltage | 50 V AC/DC |
| Contact resistance | 50 mΩ max. (at 20 mV DC max., 100 mA max.) |
| Insulation resistance | 100 MΩ min. (at 250 V DC) |
| Dielectric strength | 250 V AC for 1 min. (leakage current: 1 mA max.) |
| Insertion durability | Gold-plated: 20 times Tin-plated: 10 times |
| Ambient operating temperature | -30 to 85 °C (With no icing or condensation) |

■ Materials and Finish

| Model | Dual-sided Contact Models | | Upper sided Models |
|-----------|---|----------------------------|------------------------------|
| | Gold-plated | Tin-plated | Gold-plated |
| Housing | LCP resin (UL94 V-0)/natural | | LCP resin (UL94 V-0)/gray |
| Slider | LCP resin (UL94 V-0)/black | | |
| Contacts | Spring copper alloy/nickel substrate (1.5 μm) | | |
| | Gold-plated contacts (flash) | Tin-plated contacts (1 μm) | Gold-plated contacts (flash) |
| | Copper alloy/tin-plated (1 μm) | | |
| Hold-down | Copper alloy/tin-plated (1 μm) | | |

■ Models

| Contact type Pitch | Dual-sided contact | | Upper sided | |
|-----------------------|---------------------|-----------------|---------------------|--------------|
| | Contacts | Model | Contacts | Model |
| 0.5 mm | Gold-plated (flash) | XF3M-□□15-1B□ | Gold-plated (flash) | XF3M-□□25-1B |
| | Tin-plated | XF3M-□□15-1D | | |
| 1.0 mm | Gold-plated (flash) | XF3M(1)-□□15-1B | | |
| | Tin-plated | XF3M(1)-□□15-1D | | |

XF3M Rotary Backlock Connector (0.5-mm Pitch, 1.0-mm Pitch, Dual sided, Upper sided Contact)

XF3M 0.5-mm pitch model

■ Dimensions

(Unit: mm)

XF3M-□□15-1B
 XF3M-□□15-1BE
 XF3M-□□15-1D
 XF3M-□□25-1B

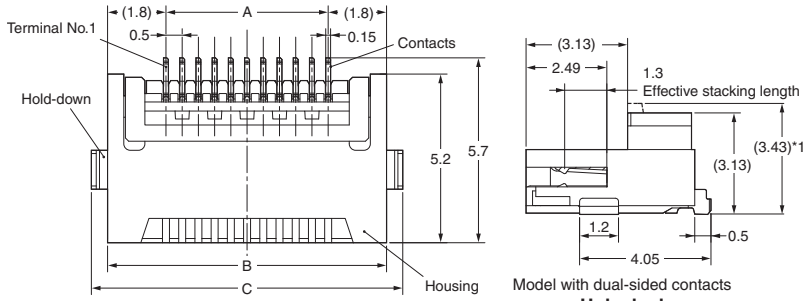

Model with dual-sided contacts
Unlocked

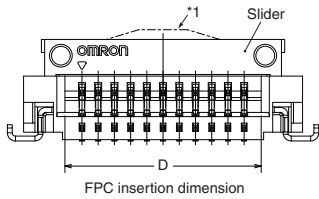

FPC insertion dimension

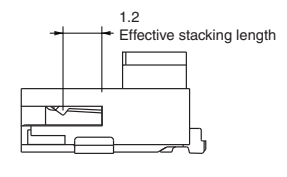

Model with single-sided contacts (upper sided) *2
Unlocked

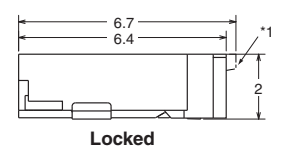

Locked

PCB Dimensions (TOP VIEW)

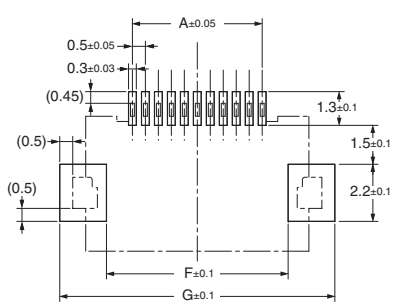

Recommended FPC/FFC Dimensions

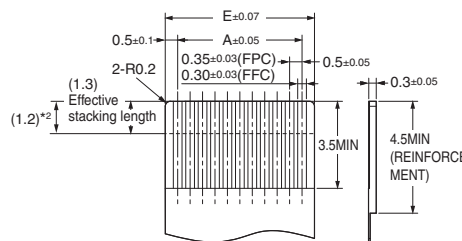

Table of Dimension

| Pins ^{*1} | A | B | C | D | E | F | G |
|--------------------|------|------|------|-------|------|------|------|
| 4 | 1.5 | 5.1 | 6.1 | 2.55 | 2.5 | 3.5 | 7.1 |
| 5 | 2.0 | 5.6 | 6.6 | 3.05 | 3.0 | 4.0 | 7.6 |
| 6 | 2.5 | 6.1 | 7.1 | 3.55 | 3.5 | 4.5 | 8.1 |
| 7 | 3.0 | 6.6 | 7.6 | 4.05 | 4.0 | 5.0 | 8.6 |
| 8 | 3.5 | 7.1 | 8.1 | 4.55 | 4.5 | 5.5 | 9.1 |
| 9 | 4.0 | 7.6 | 8.6 | 5.05 | 5.0 | 6.0 | 9.6 |
| 10 | 4.5 | 8.1 | 9.1 | 5.55 | 5.5 | 6.5 | 10.1 |
| 11 | 5.0 | 8.6 | 9.6 | 6.05 | 6.0 | 7.0 | 10.6 |
| 12 | 5.5 | 9.1 | 10.1 | 6.55 | 6.5 | 7.5 | 11.1 |
| 13 | 6.0 | 9.6 | 10.6 | 7.05 | 7.0 | 8.0 | 11.6 |
| 14 | 6.5 | 10.1 | 11.1 | 7.55 | 7.5 | 8.5 | 12.1 |
| 15 | 7.0 | 10.6 | 11.6 | 8.05 | 8.0 | 9.0 | 12.6 |
| 16 | 7.5 | 11.1 | 12.1 | 8.55 | 8.5 | 9.5 | 13.1 |
| 17 | 8.0 | 11.6 | 12.6 | 9.05 | 9.0 | 10.0 | 13.6 |
| 18 | 8.5 | 12.1 | 13.1 | 9.55 | 9.5 | 10.5 | 14.1 |
| 19 | 9.0 | 12.6 | 13.6 | 10.05 | 10.0 | 11.0 | 14.6 |
| 20 | 9.5 | 13.1 | 14.1 | 10.55 | 10.5 | 11.5 | 15.1 |
| 21 | 10.0 | 13.6 | 14.6 | 11.05 | 11.0 | 12.0 | 15.6 |
| 22 | 10.5 | 14.1 | 15.1 | 11.55 | 11.5 | 12.5 | 16.1 |
| 23 | 11.0 | 14.6 | 15.6 | 12.05 | 12.0 | 13.0 | 16.6 |
| 24 | 11.5 | 15.1 | 16.1 | 12.55 | 12.5 | 13.5 | 17.1 |
| 25 | 12.0 | 15.6 | 16.6 | 13.05 | 13.0 | 14.0 | 17.6 |
| 26 | 12.5 | 16.1 | 17.1 | 13.55 | 13.5 | 14.5 | 18.1 |
| 28 | 13.5 | 17.1 | 18.1 | 14.55 | 14.5 | 15.5 | 19.1 |
| 29 | 14.0 | 17.6 | 18.6 | 15.05 | 15.0 | 16.0 | 19.6 |
| 30 | 14.5 | 18.1 | 19.1 | 15.55 | 15.5 | 16.5 | 20.1 |
| 31 | 15.0 | 18.6 | 19.6 | 16.05 | 16.0 | 17.0 | 20.6 |
| 32 | 15.5 | 19.1 | 20.1 | 16.55 | 16.5 | 17.5 | 21.1 |
| 33 | 16.0 | 19.6 | 20.6 | 17.05 | 17.0 | 18.0 | 21.6 |
| 34 | 16.5 | 20.1 | 21.1 | 17.55 | 17.5 | 18.5 | 22.1 |
| 35 | 17.0 | 20.6 | 21.6 | 18.05 | 18.0 | 19.0 | 22.6 |
| 36 | 17.5 | 21.1 | 22.1 | 18.55 | 18.5 | 19.5 | 23.1 |
| 37 | 18.0 | 21.6 | 22.6 | 19.05 | 19.0 | 20.0 | 23.6 |
| 38 | 18.5 | 22.1 | 23.1 | 19.55 | 19.5 | 20.5 | 24.1 |
| 40 | 19.5 | 23.1 | 24.1 | 20.55 | 20.5 | 21.5 | 25.1 |
| 41 | 20.0 | 23.6 | 24.6 | 21.05 | 21.0 | 22.0 | 25.6 |
| 42 | 20.5 | 24.1 | 25.1 | 21.55 | 21.5 | 22.5 | 26.1 |
| 45 | 22.0 | 25.6 | 26.6 | 23.05 | 23.0 | 24.0 | 27.6 |
| 50 | 24.5 | 28.1 | 29.1 | 25.55 | 25.5 | 26.5 | 30.1 |
| 51 | 25.0 | 28.6 | 29.6 | 26.05 | 26.0 | 27.0 | 30.6 |
| 53 | 26.0 | 29.6 | 30.6 | 27.05 | 27.0 | 28.0 | 31.6 |
| 54 | 26.5 | 30.1 | 31.1 | 27.55 | 27.5 | 28.5 | 32.1 |
| 55 | 27.0 | 30.6 | 31.6 | 28.05 | 28.0 | 29.0 | 32.6 |
| 57 | 28.0 | 31.6 | 32.6 | 29.05 | 29.0 | 30.0 | 33.6 |
| 60 | 29.5 | 33.1 | 34.1 | 30.55 | 30.5 | 31.5 | 35.1 |
| 80 | 39.5 | 43.1 | 44.1 | 40.55 | 40.5 | 41.5 | 45.1 |

*1. Dotted lines indicate the shape and dimensions of the XF3M-8015-1BE Connectors.
 *2. For the XF3M-□□25-1B Connectors.

■ Ordering Information

● Dual-sided Contact Models - Gold-plated (flash)

1500pcs per reel

| Pins ^{*1} | Model | Pins ^{*1} | Model | Pins ^{*1} | Model | Pins ^{*1} | Model | Quantity per reel (unit) ^{*2} |
|--------------------|--------------|--------------------|--------------|--------------------|--------------|--------------------|--------------|--|
| 4 | XF3M-0415-1B | 16 | XF3M-1615-1B | 29 | XF3M-2915-1B | 42 | XF3M-4215-1B | 1,500 |
| 5 | XF3M-0515-1B | 17 | XF3M-1715-1B | 30 | XF3M-3015-1B | 45 | XF3M-4515-1B | |
| 6 | XF3M-0615-1B | 18 | XF3M-1815-1B | 31 | XF3M-3115-1B | 50 | XF3M-5015-1B | |
| 7 | XF3M-0715-1B | 19 | XF3M-1915-1B | 32 | XF3M-3215-1B | 51 | XF3M-5115-1B | |
| 8 | XF3M-0815-1B | 20 | XF3M-2015-1B | 33 | XF3M-3315-1B | 53 | XF3M-5315-1B | |
| 9 | XF3M-0915-1B | 21 | XF3M-2115-1B | 34 | XF3M-3415-1B | 54 | XF3M-5415-1B | |
| 10 | XF3M-1015-1B | 22 | XF3M-2215-1B | 35 | XF3M-3515-1B | 55 | XF3M-5515-1B | |
| 11 | XF3M-1115-1B | 23 | XF3M-2315-1B | 36 | XF3M-3615-1B | 57 | XF3M-5715-1B | |
| 12 | XF3M-1215-1B | 24 | XF3M-2415-1B | 37 | XF3M-3715-1B | 60 | XF3M-6015-1B | |
| 13 | XF3M-1315-1B | 25 | XF3M-2515-1B | 38 | XF3M-3815-1B | | | |
| 14 | XF3M-1415-1B | 26 | XF3M-2615-1B | 40 | XF3M-4015-1B | | | |
| 15 | XF3M-1515-1B | 28 | XF3M-2815-1B | 41 | XF3M-4115-1B | | | |

1000pcs per reel

| Pins ^{*1} | Model | Quantity per reel (unit) ^{*2} |
|--------------------|---------------|--|
| 80 | XF3M-8015-1BE | 1,000 |

XF3M Rotary Backlock Connector (0.5-mm Pitch, 1.0-mm Pitch, Dual sided, Upper sided Contact)

100pcs per reel

| Pins ^{*1} | Model | Pins ^{*1} | Model | Pins ^{*1} | Model | Pins ^{*1} | Model | Quantity per reel (unit) ^{*2} |
|--------------------|-------------------|--------------------|-------------------|--------------------|-------------------|--------------------|--------------------|--|
| 4 | XF3M-0415-1B-R100 | 16 | XF3M-1615-1B-R100 | 29 | XF3M-2915-1B-R100 | 42 | XF3M-4215-1B-R100 | 100 |
| 5 | XF3M-0515-1B-R100 | 17 | XF3M-1715-1B-R100 | 30 | XF3M-3015-1B-R100 | 45 | XF3M-4515-1B-R100 | |
| 6 | XF3M-0615-1B-R100 | 18 | XF3M-1815-1B-R100 | 31 | XF3M-3115-1B-R100 | 50 | XF3M-5015-1B-R100 | |
| 7 | XF3M-0715-1B-R100 | 19 | XF3M-1915-1B-R100 | 32 | XF3M-3215-1B-R100 | 51 | XF3M-5115-1B-R100 | |
| 8 | XF3M-0815-1B-R100 | 20 | XF3M-2015-1B-R100 | 33 | XF3M-3315-1B-R100 | 53 | XF3M-5315-1B-R100 | |
| 9 | XF3M-0915-1B-R100 | 21 | XF3M-2115-1B-R100 | 34 | XF3M-3415-1B-R100 | 54 | XF3M-5415-1B-R100 | |
| 10 | XF3M-1015-1B-R100 | 22 | XF3M-2215-1B-R100 | 35 | XF3M-3515-1B-R100 | 55 | XF3M-5515-1B-R100 | |
| 11 | XF3M-1115-1B-R100 | 23 | XF3M-2315-1B-R100 | 36 | XF3M-3615-1B-R100 | 57 | XF3M-5715-1B-R100 | |
| 12 | XF3M-1215-1B-R100 | 24 | XF3M-2415-1B-R100 | 37 | XF3M-3715-1B-R100 | 60 | XF3M-6015-1B-R100 | |
| 13 | XF3M-1315-1B-R100 | 25 | XF3M-2515-1B-R100 | 38 | XF3M-3815-1B-R100 | 80 | XF3M-8015-1BE-R100 | |
| 14 | XF3M-1415-1B-R100 | 26 | XF3M-2615-1B-R100 | 40 | XF3M-4015-1B-R100 | | | |
| 15 | XF3M-1515-1B-R100 | 28 | XF3M-2815-1B-R100 | 41 | XF3M-4115-1B-R100 | | | |

● Dual-sided Contact Models - Tin-plated

1500pcs per reel

| Pins ^{*1} | Model | Pins ^{*1} | Model | Pins ^{*1} | Model | Pins ^{*1} | Model | Quantity per reel (unit) ^{*2} |
|--------------------|--------------|--------------------|--------------|--------------------|--------------|--------------------|--------------|--|
| (4) | XF3M-0415-1D | (14) | XF3M-1415-1D | (24) | XF3M-2415-1D | (35) | XF3M-3515-1D | 1,500 |
| (5) | XF3M-0515-1D | (15) | XF3M-1515-1D | (25) | XF3M-2515-1D | (36) | XF3M-3615-1D | |
| (6) | XF3M-0615-1D | (16) | XF3M-1615-1D | (26) | XF3M-2615-1D | (37) | XF3M-3715-1D | |
| (7) | XF3M-0715-1D | (17) | XF3M-1715-1D | (28) | XF3M-2815-1D | (38) | XF3M-3815-1D | |
| (8) | XF3M-0815-1D | (18) | XF3M-1815-1D | (29) | XF3M-2915-1D | (40) | XF3M-4015-1D | |
| (9) | XF3M-0915-1D | (19) | XF3M-1915-1D | (30) | XF3M-3015-1D | (41) | XF3M-4115-1D | |
| 10 | XF3M-1015-1D | (20) | XF3M-2015-1D | (31) | XF3M-3115-1D | (42) | XF3M-4215-1D | |
| (11) | XF3M-1115-1D | (21) | XF3M-2115-1D | (32) | XF3M-3215-1D | (45) | XF3M-4515-1D | |
| (12) | XF3M-1215-1D | (22) | XF3M-2215-1D | (33) | XF3M-3315-1D | (50) | XF3M-5015-1D | |
| (13) | XF3M-1315-1D | (23) | XF3M-2315-1D | (34) | XF3M-3415-1D | | | |

100pcs per reel

| Pins ^{*1} | Model | Pins ^{*1} | Model | Pins ^{*1} | Model | Pins ^{*1} | Model | Quantity per reel (unit) ^{*2} |
|--------------------|-------------------|--------------------|-------------------|--------------------|-------------------|--------------------|-------------------|--|
| (4) | XF3M-0415-1D-R100 | (14) | XF3M-1415-1D-R100 | (24) | XF3M-2415-1D-R100 | (35) | XF3M-3515-1D-R100 | 100 |
| (5) | XF3M-0515-1D-R100 | (15) | XF3M-1515-1D-R100 | (25) | XF3M-2515-1D-R100 | (36) | XF3M-3615-1D-R100 | |
| (6) | XF3M-0615-1D-R100 | (16) | XF3M-1615-1D-R100 | (26) | XF3M-2615-1D-R100 | (37) | XF3M-3715-1D-R100 | |
| (7) | XF3M-0715-1D-R100 | (17) | XF3M-1715-1D-R100 | (28) | XF3M-2815-1D-R100 | (38) | XF3M-3815-1D-R100 | |
| (8) | XF3M-0815-1D-R100 | (18) | XF3M-1815-1D-R100 | (29) | XF3M-2915-1D-R100 | (40) | XF3M-4015-1D-R100 | |
| (9) | XF3M-0915-1D-R100 | (19) | XF3M-1915-1D-R100 | (30) | XF3M-3015-1D-R100 | (41) | XF3M-4115-1D-R100 | |
| 10 | XF3M-1015-1D-R100 | (20) | XF3M-2015-1D-R100 | (31) | XF3M-3115-1D-R100 | (42) | XF3M-4215-1D-R100 | |
| (11) | XF3M-1115-1D-R100 | (21) | XF3M-2115-1D-R100 | (32) | XF3M-3215-1D-R100 | (45) | XF3M-4515-1D-R100 | |
| (12) | XF3M-1215-1D-R100 | (22) | XF3M-2215-1D-R100 | (33) | XF3M-3315-1D-R100 | (50) | XF3M-5015-1D-R100 | |
| (13) | XF3M-1315-1D-R100 | (23) | XF3M-2315-1D-R100 | (34) | XF3M-3415-1D-R100 | | | |

● Upper-sided Models - Gold-plated (flash)

1500pcs per reel

| Pins ^{*1} | Model | Pins ^{*1} | Model | Pins ^{*1} | Model | Pins ^{*1} | Model | Quantity per reel (unit) ^{*2} |
|--------------------|--------------|--------------------|--------------|--------------------|--------------|--------------------|--------------|--|
| (4) | XF3M-0425-1B | 13 | XF3M-1325-1B | 22 | XF3M-2225-1B | (32) | XF3M-3225-1B | 1,500 |
| (5) | XF3M-0525-1B | 14 | XF3M-1425-1B | (23) | XF3M-2325-1B | (33) | XF3M-3325-1B | |
| (6) | XF3M-0625-1B | (15) | XF3M-1525-1B | 24 | XF3M-2425-1B | (34) | XF3M-3425-1B | |
| 7 | XF3M-0725-1B | 16 | XF3M-1625-1B | (25) | XF3M-2525-1B | (35) | XF3M-3525-1B | |
| 8 | XF3M-0825-1B | (17) | XF3M-1725-1B | 26 | XF3M-2625-1B | (36) | XF3M-3625-1B | |
| 9 | XF3M-0925-1B | 18 | XF3M-1825-1B | (28) | XF3M-2825-1B | (37) | XF3M-3725-1B | |
| 10 | XF3M-1025-1B | (19) | XF3M-1925-1B | (29) | XF3M-2925-1B | (38) | XF3M-3825-1B | |
| (11) | XF3M-1125-1B | 20 | XF3M-2025-1B | (30) | XF3M-3025-1B | 40 | XF3M-4025-1B | |
| 12 | XF3M-1225-1B | (21) | XF3M-2125-1B | (31) | XF3M-3125-1B | | | |

100pcs per reel

| Pins ^{*1} | Model | Pins ^{*1} | Model | Pins ^{*1} | Model | Pins ^{*1} | Model | Quantity per reel (unit) ^{*2} |
|--------------------|-------------------|--------------------|-------------------|--------------------|-------------------|--------------------|-------------------|--|
| (4) | XF3M-0425-1B-R100 | (13) | XF3M-1325-1B-R100 | (22) | XF3M-2225-1B-R100 | (32) | XF3M-3225-1B-R100 | 100 |
| (5) | XF3M-0525-1B-R100 | (14) | XF3M-1425-1B-R100 | (23) | XF3M-2325-1B-R100 | (33) | XF3M-3325-1B-R100 | |
| (6) | XF3M-0625-1B-R100 | (15) | XF3M-1525-1B-R100 | (24) | XF3M-2425-1B-R100 | (34) | XF3M-3425-1B-R100 | |
| (7) | XF3M-0725-1B-R100 | (16) | XF3M-1625-1B-R100 | (25) | XF3M-2525-1B-R100 | (35) | XF3M-3525-1B-R100 | |
| (8) | XF3M-0825-1B-R100 | (17) | XF3M-1725-1B-R100 | (26) | XF3M-2625-1B-R100 | (36) | XF3M-3625-1B-R100 | |
| (9) | XF3M-0925-1B-R100 | 18 | XF3M-1825-1B-R100 | (28) | XF3M-2825-1B-R100 | (37) | XF3M-3725-1B-R100 | |
| (10) | XF3M-1025-1B-R100 | (19) | XF3M-1925-1B-R100 | (29) | XF3M-2925-1B-R100 | (38) | XF3M-3825-1B-R100 | |
| (11) | XF3M-1125-1B-R100 | (20) | XF3M-2025-1B-R100 | (30) | XF3M-3025-1B-R100 | (40) | XF3M-4025-1B-R100 | |
| (12) | XF3M-1225-1B-R100 | (21) | XF3M-2125-1B-R100 | (31) | XF3M-3125-1B-R100 | | | |

*1. Please consult your OMRON representative for available pin count.
Please consult your OMRON representative for the marketing dates for pin counts in parentheses.
*2. Please order by integer multiple of the quantity per reel.

XF3M Rotary Backlock Connector (0.5-mm Pitch, 1.0-mm Pitch, Dual sided, Upper sided Contact)

XF3M(1) 1.0-mm pitch model

■ Dimensions

(Unit: mm)

XF3M(1)-□□15-1B

XF3M(1)-□□15-1D

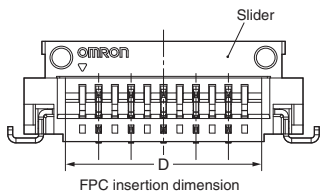
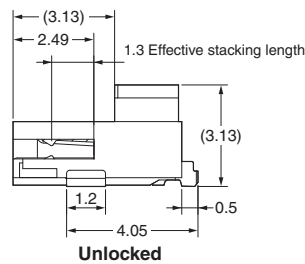
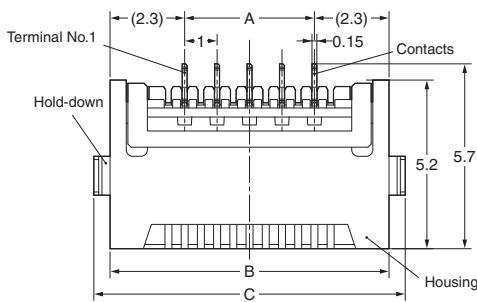

PCB Dimensions (TOP VIEW)

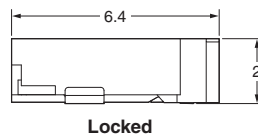

Recommended FPC/FFC Dimensions

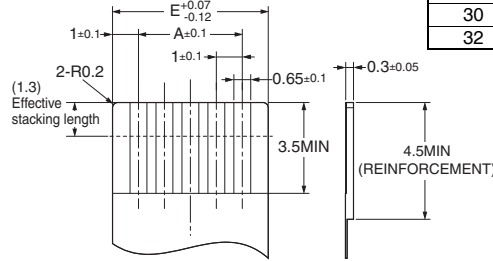
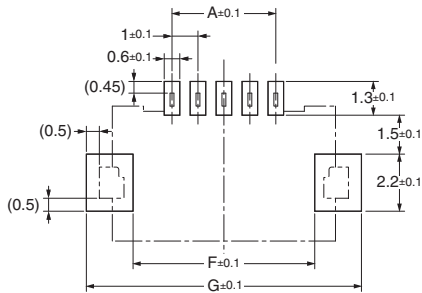

Table of Dimensions

| Pins*1 | A | B | C | D | E | F | G |
|--------|------|------|------|-------|------|------|------|
| 4 | 3.0 | 7.6 | 8.6 | 5.05 | 5.0 | 6.0 | 9.6 |
| 5 | 4.0 | 8.6 | 9.6 | 6.05 | 6.0 | 7.0 | 10.6 |
| 6 | 5.0 | 9.6 | 10.6 | 7.05 | 7.0 | 8.0 | 11.6 |
| 7 | 6.0 | 10.6 | 11.6 | 8.05 | 8.0 | 9.0 | 12.6 |
| 8 | 7.0 | 11.6 | 12.6 | 9.05 | 9.0 | 10.0 | 13.6 |
| 9 | 8.0 | 12.6 | 13.6 | 10.05 | 10.0 | 11.0 | 14.6 |
| 10 | 9.0 | 13.6 | 14.6 | 11.05 | 11.0 | 12.0 | 15.6 |
| 11 | 10.0 | 14.6 | 15.6 | 12.05 | 12.0 | 13.0 | 16.6 |
| 12 | 11.0 | 15.6 | 16.6 | 13.05 | 13.0 | 14.0 | 17.6 |
| 14 | 13.0 | 17.6 | 18.6 | 15.05 | 15.0 | 16.0 | 19.6 |
| 15 | 14.0 | 18.6 | 19.6 | 16.05 | 16.0 | 17.0 | 20.6 |
| 16 | 15.0 | 19.6 | 20.6 | 17.05 | 17.0 | 18.0 | 21.6 |
| 17 | 16.0 | 20.6 | 21.6 | 18.05 | 18.0 | 19.0 | 22.6 |
| 18 | 17.0 | 21.6 | 22.6 | 19.05 | 19.0 | 20.0 | 23.6 |
| 20 | 19.0 | 23.6 | 24.6 | 21.05 | 21.0 | 22.0 | 25.6 |
| 22 | 21.0 | 25.6 | 26.6 | 23.05 | 23.0 | 24.0 | 27.6 |
| 23 | 22.0 | 26.6 | 27.6 | 24.05 | 24.0 | 25.0 | 28.6 |
| 24 | 23.0 | 27.6 | 28.6 | 25.05 | 25.0 | 26.0 | 29.6 |
| 25 | 24.0 | 28.6 | 29.6 | 26.05 | 26.0 | 27.0 | 30.6 |
| 26 | 25.0 | 29.6 | 30.6 | 27.05 | 27.0 | 28.0 | 31.6 |
| 28 | 27.0 | 31.6 | 32.6 | 29.05 | 29.0 | 30.0 | 33.6 |
| 30 | 29.0 | 33.6 | 34.6 | 31.05 | 31.0 | 32.0 | 35.6 |
| 32 | 31.0 | 35.6 | 36.6 | 33.05 | 33.0 | 34.0 | 37.6 |

■ Ordering Information

● Dual-sided Contact Models - Gold-plated (flash)

1500pcs per reel

| Pins*1 | Model | Pins*1 | Model | Pins*1 | Model | Pins*1 | Model | Quantity per reel (unit) ^{*2} |
|--------|-----------------|--------|-----------------|--------|-----------------|--------|-----------------|--|
| 4 | XF3M(1)-0415-1B | 10 | XF3M(1)-1015-1B | (17) | XF3M(1)-1715-1B | 25 | XF3M(1)-2515-1B | 1,500 |
| 5 | XF3M(1)-0515-1B | 11 | XF3M(1)-1115-1B | 18 | XF3M(1)-1815-1B | 26 | XF3M(1)-2615-1B | |
| 6 | XF3M(1)-0615-1B | 12 | XF3M(1)-1215-1B | 20 | XF3M(1)-2015-1B | 28 | XF3M(1)-2815-1B | |
| 7 | XF3M(1)-0715-1B | 14 | XF3M(1)-1415-1B | 22 | XF3M(1)-2215-1B | 30 | XF3M(1)-3015-1B | |
| 8 | XF3M(1)-0815-1B | 15 | XF3M(1)-1515-1B | 23 | XF3M(1)-2315-1B | 32 | XF3M(1)-3215-1B | |
| 9 | XF3M(1)-0915-1B | 16 | XF3M(1)-1615-1B | (24) | XF3M(1)-2415-1B | | | |

100pcs per reel

| Pins*1 | Model | Pins*1 | Model | Pins*1 | Model | Pins*1 | Model | Quantity per reel (unit) ^{*2} |
|--------|----------------------|--------|----------------------|--------|----------------------|--------|----------------------|--|
| 4 | XF3M(1)-0415-1B-R100 | 10 | XF3M(1)-1015-1B-R100 | (17) | XF3M(1)-1715-1B-R100 | (25) | XF3M(1)-2515-1B-R100 | 100 |
| 5 | XF3M(1)-0515-1B-R100 | 11 | XF3M(1)-1115-1B-R100 | 18 | XF3M(1)-1815-1B-R100 | 26 | XF3M(1)-2615-1B-R100 | |
| 6 | XF3M(1)-0615-1B-R100 | 12 | XF3M(1)-1215-1B-R100 | 20 | XF3M(1)-2015-1B-R100 | (28) | XF3M(1)-2815-1B-R100 | |
| 7 | XF3M(1)-0715-1B-R100 | 14 | XF3M(1)-1415-1B-R100 | 22 | XF3M(1)-2215-1B-R100 | 30 | XF3M(1)-3015-1B-R100 | |
| 8 | XF3M(1)-0815-1B-R100 | 15 | XF3M(1)-1515-1B-R100 | 23 | XF3M(1)-2315-1B-R100 | (32) | XF3M(1)-3215-1B-R100 | |
| 9 | XF3M(1)-0915-1B-R100 | 16 | XF3M(1)-1615-1B-R100 | (24) | XF3M(1)-2415-1B-R100 | | | |

● Dual-sided Contact Models - Tin-plated

1500pcs per reel

| Pins*1 | Model | Pins*1 | Model | Pins*1 | Model | Pins*1 | Model | Quantity per reel (unit) ^{*2} |
|--------|-----------------|--------|-----------------|--------|-----------------|--------|-----------------|--|
| (4) | XF3M(1)-0415-1D | 10 | XF3M(1)-1015-1D | (17) | XF3M(1)-1715-1D | (25) | XF3M(1)-2515-1D | 1,500 |
| (5) | XF3M(1)-0515-1D | (11) | XF3M(1)-1115-1D | 18 | XF3M(1)-1815-1D | (26) | XF3M(1)-2615-1D | |
| (6) | XF3M(1)-0615-1D | 12 | XF3M(1)-1215-1D | 20 | XF3M(1)-2015-1D | (28) | XF3M(1)-2815-1D | |
| (7) | XF3M(1)-0715-1D | (14) | XF3M(1)-1415-1D | 22 | XF3M(1)-2215-1D | (30) | XF3M(1)-3015-1D | |
| (8) | XF3M(1)-0815-1D | (15) | XF3M(1)-1515-1D | (23) | XF3M(1)-2315-1D | (32) | XF3M(1)-3215-1D | |
| (9) | XF3M(1)-0915-1D | (16) | XF3M(1)-1615-1D | (24) | XF3M(1)-2415-1D | | | |

100pcs per reel

| Pins*1 | Model | Pins*1 | Model | Pins*1 | Model | Pins*1 | Model | Quantity per reel (unit) ^{*2} |
|--------|----------------------|--------|----------------------|--------|----------------------|--------|----------------------|--|
| (4) | XF3M(1)-0415-1D-R100 | 10 | XF3M(1)-1015-1D-R100 | (17) | XF3M(1)-1715-1D-R100 | (25) | XF3M(1)-2515-1D-R100 | 100 |
| (5) | XF3M(1)-0515-1D-R100 | (11) | XF3M(1)-1115-1D-R100 | (18) | XF3M(1)-1815-1D-R100 | (26) | XF3M(1)-2615-1D-R100 | |
| (6) | XF3M(1)-0615-1D-R100 | (12) | XF3M(1)-1215-1D-R100 | (20) | XF3M(1)-2015-1D-R100 | (28) | XF3M(1)-2815-1D-R100 | |
| (7) | XF3M(1)-0715-1D-R100 | (14) | XF3M(1)-1415-1D-R100 | (22) | XF3M(1)-2215-1D-R100 | (30) | XF3M(1)-3015-1D-R100 | |
| (8) | XF3M(1)-0815-1D-R100 | (15) | XF3M(1)-1515-1D-R100 | (23) | XF3M(1)-2315-1D-R100 | (32) | XF3M(1)-3215-1D-R100 | |
| (9) | XF3M(1)-0915-1D-R100 | (16) | XF3M(1)-1615-1D-R100 | (24) | XF3M(1)-2415-1D-R100 | | | |

*1. Please consult your OMRON representative for available pin count.
Please consult your OMRON representative for the marketing dates for pin counts in parentheses.
*2. Please order by integer multiple of the quantity per reel.

X-ON Electronics

Largest Supplier of Electrical and Electronic Components

Click to view similar products for [FFC & FPC Connectors](#) category:

Click to view products by [Omron](#) manufacturer:

Other Similar products are found below :

[HFW11R-1STE1H1LF](#) [FH29B-100S-0.2SHW\(99\)](#) [FA5S008HP1](#) [FH29B-120S-0.2SHW\(99\)](#) [FH29B-80S-0.2SHW\(99\)](#) [FHS-16](#) [FPH-2022G](#)
[52610-1075](#) [52610-1275](#) [52610-1934](#) [XF3M\(1\)-1415-1B-R100](#) [501864-3091-TR225](#) [0525594033](#) [086210010340800](#) [086222026001800](#)
[52271-2869-CUT-TAPE](#) [62684-36210E9ALF](#) [52610-1675](#) [52746-1671-TR250](#) [AYF330735](#) [10051922-2810EHLF](#) [6-520415-9](#) [BD021-09A-](#)
[A1-0350-0200-0550-LD](#) [SFV6R-1STE9HLF](#) [XF3M-2915-1B-R100](#) [1658549-1](#) [62674-221121ALF](#) [151660622](#) [842-816-2630-035](#)
[AYF530665TA](#) [AYF351525](#) [046296011930846+](#) [AYF352325A](#) [046254020000800+](#) [FH19C-13S-0.5SH\(99\)](#) [FH39J-51S-0.3SHW\(99\)](#)
[AYF530365TA](#) [FH29B-44S-0.2SHW\(99\)](#) [SFW5R-2STAE9LF](#) [62684-502100AHLF](#) [FH39-61S-0.3SHW\(99\)](#) [AYF414035A](#) [10064555-](#)
[172520HLF](#) [AYF212335A](#) [504754-2500](#) [SFW7S-2STME1LF](#) [FH39-45S-0.3SHW\(99\)](#) [MA49-19S-2.54DSA](#) [FH19SC-12S-0.5SH\(99\)](#)
[SFW6S-2STE9LF](#)