

Industrial Ethernet Connectors

XS5/XS6

Support for Ethernet/IP, Ether-CAT, and Other Popular Networks Based on Ethernet







- A lineup of Tough RJ45 Connectors for use outside of panels and Environment-resistance Connectors with IP67 protection (M12).
- RJ45 Assembly Connectors are available for easy wiring onsite.
- SmartClick Connectors are used on Environment-resistance Connectors (M12) and provide compatibility with traditional screw connectors for one-touch (1/8 turn) connection.
- AWG22 cables that are suitable for wiring outside of panels are used for all models.
- More variations with the addition of Cables with Right-angle Connectors and Straight Terminals for PCBs.



Ordering Information

Appearance	Type	Cable length (m)	Model
	Cable with Connector on One End (M12 straight)	0.5	XS5H-T421-BM0-K
		1	XS5H-T421-CM0-K
		2	XS5H-T421-DM0-K
		3	XS5H-T421-EM0-K
		5	XS5H-T421-GM0-K
		10	XS5H-T421-JM0-K
		15	XS5H-T421-KM0-K
	Cable with Connectors on Both Ends (M12 straight/M12 straight)	0.5	XS5W-T421-BM2-K
		1	XS5W-T421-CM2-K
		2	XS5W-T421-DM2-K
		3	XS5W-T421-EM2-K
		5	XS5W-T421-GM2-K
		10	XS5W-T421-JM2-K
		15	XS5W-T421-KM2-K
	Cable with Connectors on Both Ends (M12 straight/RJ45)	0.3	XS5W-T421-AMC-K
		0.5	XS5W-T421-BMC-K
		1	XS5W-T421-CMC-K
		2	XS5W-T421-DMC-K
		3	XS5W-T421-EMC-K
		5	XS5W-T421-GMC-K
		10	XS5W-T421-JMC-K
15	XS5W-T421-KMC-K		
 Available soon.	Cable with Connector on One End (M12 right-angle)	0.5	XS5H-T422-BM0-K
		1	XS5H-T422-CM0-K
		2	XS5H-T422-DM0-K
		3	XS5H-T422-EM0-K
		5	XS5H-T422-GM0-K
		10	XS5H-T422-JM0-K
		15	XS5H-T422-KM0-K
 Available soon.	Cable with Connectors on Both Ends (M12 right-angle/M12 right-angle)	0.5	XS5W-T422-BM2-K
		1	XS5W-T422-CM2-K
		2	XS5W-T422-DM2-K
		3	XS5W-T422-EM2-K
		5	XS5W-T422-GM2-K
		10	XS5W-T422-JM2-K
		15	XS5W-T422-KM2-K

Appearance	Type		Cable length (m)	Model
 <p>Available soon.</p>	Cable with Connectors on Both Ends (M12 right-angle/RJ45)		0.3	XS5W-T422-AMC-K
			0.5	XS5W-T422-BMC-K
			1	XS5W-T422-CMC-K
			2	XS5W-T422-DMC-K
			3	XS5W-T422-EMC-K
			5	XS5W-T422-GMC-K
			10	XS5W-T422-JMC-K
			15	XS5W-T422-KMC-K
	Cable with Connectors on Both Ends (RJ45/RJ45)		0.3	XS5W-T421-AMD-K
			0.5	XS5W-T421-BMD-K
			1	XS5W-T421-CMD-K
			2	XS5W-T421-DMD-K
			3	XS5W-T421-EMD-K
			5	XS5W-T421-GMD-K
			10	XS5W-T421-JMD-K
			15	XS5W-T421-KMD-K
	RJ45 Assembly Connector		---	XS6G-T421-1
	M12 Connector for Panel Mounting	Rear locking	0.5	XS5P-T426-5
		Front locking	0.5	XS5P-T427-5
 <p>NEW</p>	M12 Panel-mounting PCB Straight Terminals		---	XS5P-T426-1

Specifications

Type	Cable with Connector on One End (M12)	Cable with Connectors on Both Ends (M12/M12)	Cable with Connectors on Both Ends (M12/RJ45)	Cable with Connectors on Both Ends (RJ45/RJ45)	RJ45 Assembly Connector	M12 Connector for Panel Mounting	M12 Panel-mounting PCB Straight Terminals
Item Model	XS5H -T42□-□M0-K	XS5W -T42□-□M2-K	XS5W -T42□-□MC-K	XS5W -T421-□MD-K	XS6G -T421-1	XS5P-T42□-5	XS5P-T426-1
Rated current	3 A		2.5 A			3 A	4 A
Rated voltage	30 V						125 VDC
Contact resistance	40 mΩ max.						40 mΩ max.
Insulation resistance	1,000 MΩ min.		500 MΩ min.		1,000 MΩ min.		1,000 MΩ min.
Withstand voltage	1,000 VAC for 60 s (leak current: 1 mA max.)						1,500 VAC for 60 s (leakage current: 1 mA max.)
Ambient operating temperature	-25 to 70°C				-40 to 70°C	-25 to 70°C	-25 to 70°C
Ambient storage temperature	-25 to 70°C				-40 to 70°C	-25 to 70°C	-25 to 70°C
Protective structure	M12: IEC IP67, RJ45: IEC IP20						IEC IP67

Materials and Finish

Connectors

Item	Model	M12			RJ45
		XS5H and XS5W	XS5P-T42□-5	XS5P-T426-1	XS5W and XS6G
Contact blocks		PBT resin (UL94V-0)/light gray	PBT resin (UL94V-0)/light gray	PA resin (UL94V-0)/black	PA resin (UL94V-0)/black
Contacts		Phosphor bronze/nickel base, gold plated (0.4 μm)	Phosphor bronze/nickel base, gold plated (0.4 μm)	Bronze/nickel base, gold plated (0.4 μm)	Phosphor bronze/nickel base, gold plated (1.4 μm)
Anchors		Zinc diecast/nickel plating	Zinc diecast/nickel plating	Zinc diecast/nickel plating (5 μm)	---
Anchors (tabs)		SUS	---	---	---
Cover		Soft PBT (UL94 V-0)	---	---	---
Sealing resin		---	Epoxy resin	---	---
O-rings		Rubber	Rubber	Rubber	---
Grounding fixture		---	---	Phosphor bronze/nickel base, tin plated (2.0 μm)	---
Anchor cover		---	---	SUS	---
Nuts		---	Bronze/nickel plated (1.5 μm)	Bronze/nickel plated (1.5 μm)	---

Cables

Specifications	UL CM PVC (double shielding) Cat. 5E
Cores and colors	AWG22 (0.26/7): Yellow, orange, white, and blue
Outer diameter	6.5 mm
Sheath color	Light blue

Note: Connectors with cables only. (XS5H and XS5W)

■ Dimensions

(Unit: mm)

● Cable with Connector on One End (M12 Straight) XS5H-T421-□M0-K

Wiring

Terminal No.	Color
1	Yellow
2	White
3	Orange
4	Blue

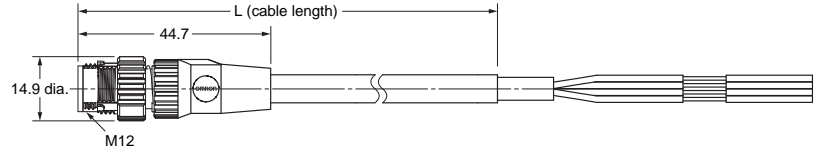

● Cable with Connectors on Both Ends (M12 Straight/M12 Straight) XS5W-T421-□M2-K

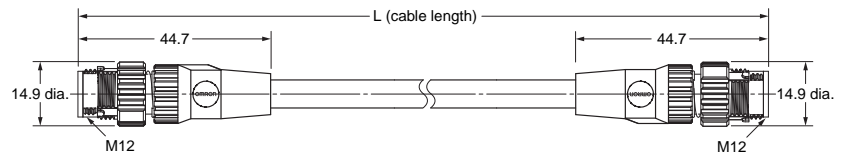

● Cable with Connectors on Both Ends (M12 Straight/RJ45) XS5W-T421-□MC-K

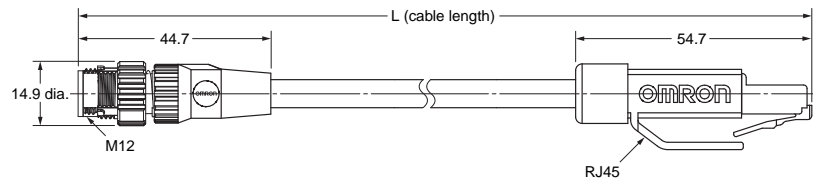

● Cable with Connector on One End (M12 Right-angle)

XS5H-T422-□M0-K

Available soon.

Wiring

Terminal No.	Color
1	Yellow
2	White
3	Orange
4	Blue

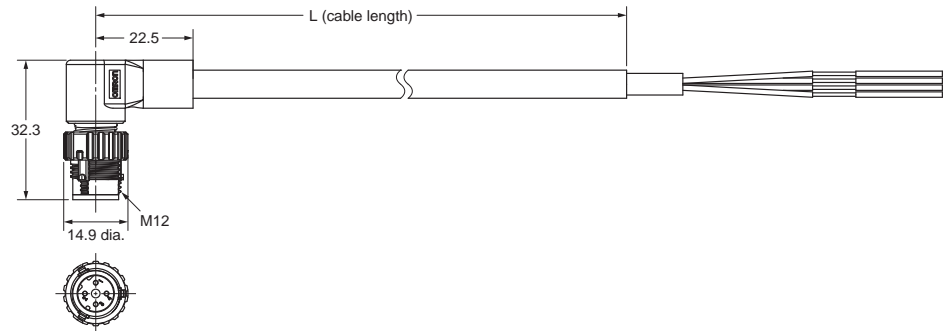

● Cable with Connectors on Both Ends (M12 Right-angle/M12 Right-angle)

XS5W-T422-□M2-K

Available soon

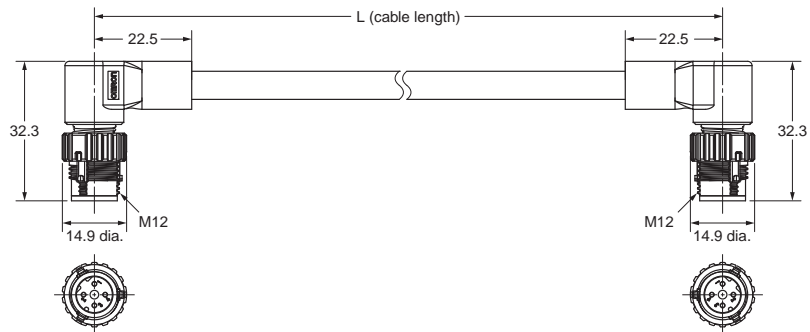

● Cable with Connectors on Both Ends (M12 Right-angle/RJ45)

XS5W-T422-□M2-K

Available soon

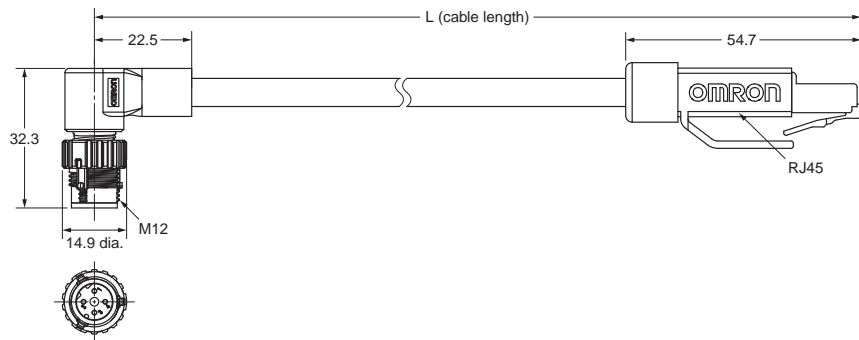

● Cable with Connectors on Both Ends (RJ45/RJ45)

XS5W-T421-□MD-K

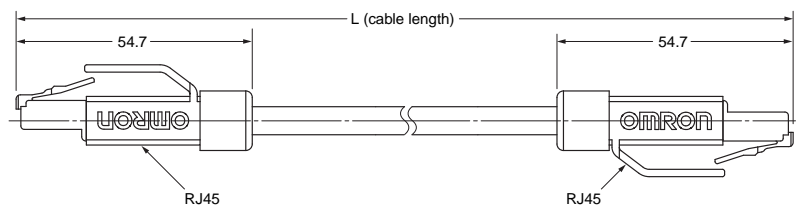

● Assembly Connector (RJ45) XS6G-T421-1

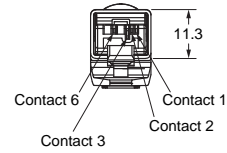
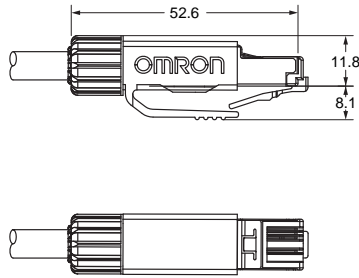

Applicable wires

6.1 to 6.9 dia.
Stranded wires: AWG22 to AWG24
Solid wires: AWG22 to AWG23

● M12 Connector for Panel mounting XS5P-T42□-5



XS5P-T426-5 (Rear Locking)

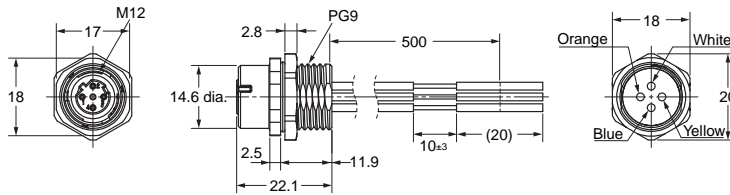

XS5P-T427-5 (Front Locking)

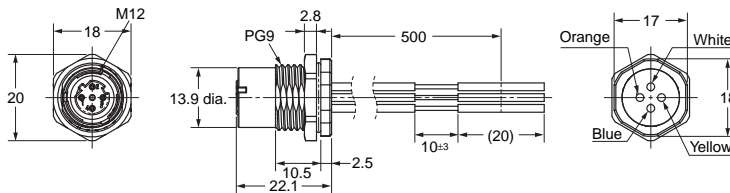

Wiring

Terminal No.	Color
1	Yellow
2	White
3	Orange
4	Blue

Panel Cutout Dimension

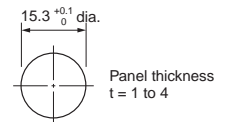

Note 1: The panel cutout dimension is the same for Front-locking and Rear-locking Connectors.

Note 2: Rotational positioning is not possible for connector rotation.

● Panel-mounting PCB Straight Terminals (M12) XS5P-T426-1

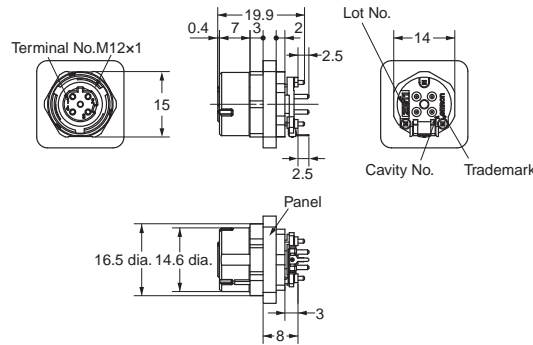

Mounting Hole Dimensions (D Cut Structure)

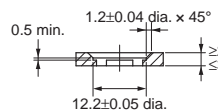
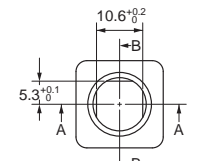

Cross-section Diagram A-A

Cross-section Diagram B-B

Mounting Hole Dimensions (C-C)

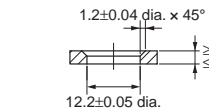
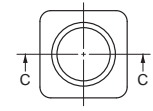

Cross-section Diagram C-C

Panel Processing Dimensions

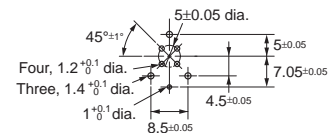

Assembly Procedure

● RJ45 Assembly Connectors

XS6G-T421-1

1. Pass the cable through the cable clamp and the connector housing
2. Strip the cable sheath and ground braiding to the correct lengths.
3. Follow the color codes and prepare to insert the wires into the splice piece.
4. Insert the wires into the splice piece for the length of the splice piece.
5. Place the splice piece into the RJ45 data module and engage it.
6. Place the data module and the splice piece on the IDC assembly housing.
7. Press the data module and the IDC assembly housing together and use pliers or a similar device to make the insulation displacement contact.
8. Remove the data module from the IDC assembly housing.
9. Place the upper screen plate on the data module and press it over the ground braiding of the cable.
10. Place the lower screen plate on the bottom of the data module, align it with the upper screen plate, and latch it until you hear it click into place.
11. Slide the housing that you placed around the cable in step 1 up to the data module and latch it until you hear it click into place.
12. Tighten the cable clamp.

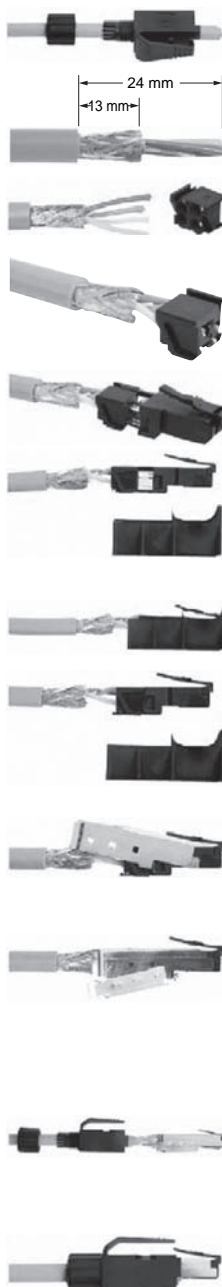

Pin Assignments

Pin Assignments for Fast Ethernet 10/100 Mbps

Function/Signal	Wire color			Pin No.
	Industrial Ethernet	EIA/TIA 568A	EIA/TIA 568B	
Transmission Data+/TD+	YE	WH/GN	WH/OG	1
Transmission Data-/TD-	OG	GN	OG	2
Receiver Data/RD+	WH	WH/OG	WH	3
Receiver Data/RD-	BU	OG	GN	6

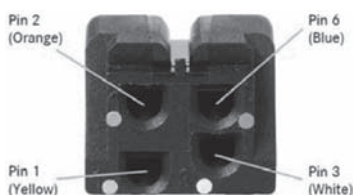

● M12 Panel-mounting PCB Straight Terminals

XS5P-T426-1

Confirming the Number of Parts

The following four parts are included in the package when it is delivered.

Panel-mounting Parts

1. Anchor

2. O-Ring

3. Nut

PCB-mounting Part

4. Connector



Assembly Procedure

1. Mount the connector to the PCB.

2. Attach the anchor to the panel with the nut.

Mounting the Connector to the PCB

Mounting the Anchor to the Panel

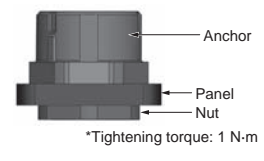
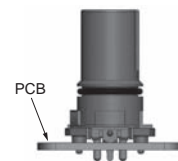

3. Attach the connector that you mounted to the PCB to the panel.

* Make sure that the connector and anchor are oriented correctly.

Attachment

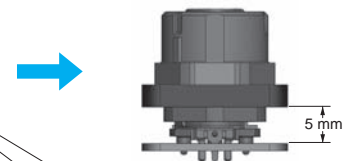
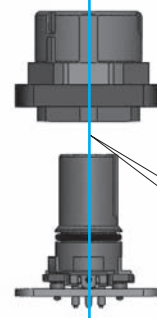

4. Temporarily mount the O-ring to the top of the connector at the mating surface.

Temporary Mounting of the O-Ring

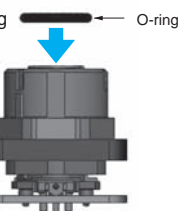

5. Mate the Connector Waterproof Cover (XS2Z-22, sold separately) or the Partner Connector Plug (XS5H-T42□-□M0-K, sold separately) and press the O-ring to the O-ring position after mounting.

Mounting the O-Ring

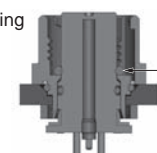

● Connector Waterproof Cover (Sold Separately)

XS2Z-22

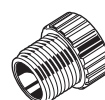

* Tightening torque: 0.39 to 0.49 N·m

■ Safety Precautions

Precautions for Correct Use

Do not use the Connectors in an atmosphere or environment that exceeds the specifications.

● Connector Connection and Disconnection

- When connecting or disconnecting Connectors, be sure to hold the Connectors.
- Do not hold the cable when disconnecting Connectors.
- When joining Connectors, be sure to insert the plug all the way to the back of the socket before attempting to lock the Connectors.
- Do not use tools of any sort to join the Connectors. Always use your hands. Pliers or other tools may damage the Connectors.

● Wiring

Lay the cables so that external force is not applied to the Connectors. Otherwise, the degree of protection (IP67) may not be achieved.

● Degree of Protection for M12/SmartClick Connectors

- The degree of protection of Connectors (IP67) is not for a fully watertight structure. Do not use the Connectors underwater.
- Do not step on or place any objects on the Connectors. Doing so may damage the Connectors.

● Handling Precautions

- Do not pull on the Connectors or cables with excessive force. Do not install the Connectors with a load placed directly on the joint or at the point where the wires connect to the Connector. The Connector may be damaged or the wires in the cable may be disconnected.
- Lay the cable where it will not be stepped on to prevent the wires in the cable from being disconnected and to protect the Connectors from being damaged. If the cable must be placed where it will be stepped on, install a protective cover.
- When bending cables, do not exceed the cable specifications.

• Application examples provided in this document are for reference only. In actual applications, confirm equipment functions and safety before using the product.
 • Consult your OMRON representative before using the product under conditions which are not described in the manual or applying the product to nuclear control systems, railroad systems, aviation systems, vehicles, combustion systems, medical equipment, amusement machines, safety equipment, and other systems or equipment that may have a serious influence on lives and property if used improperly. Make sure that the ratings and performance characteristics of the product provide a margin of safety for the system or equipment, and be sure to provide the system or equipment with double safety mechanisms.

OMRON Corporation Industrial Automation Company
Tokyo, JAPAN

Contact: www.ia.omron.com

Regional Headquarters

OMRON EUROPE B.V.

Wegalaan 67-69-2132 JD Hoofddorp
The Netherlands
Tel: (31)2356-81-300/Fax: (31)2356-81-388

OMRON ELECTRONIC COMPONENTS LLC

55 Commerce Drive, Suite B,
Shaumburg, IL, 60173, U.S.A.
Tel: (1) 847-882-2288/Fax: (1) 847-882-2192

OMRON ASIA PACIFIC PTE. LTD.

No. 438A Alexandra Road # 05-05/08 (Lobby 2),
Alexandra Technopark,
Singapore 119967
Tel: (65) 6835-3011/Fax: (65) 6835-2711

OMRON (CHINA) CO., LTD.

Room 2211, Bank of China Tower,
200 Yin Cheng Zhong Road,
PuDong New Area, Shanghai, 200120, China
Tel: (86) 21-5037-2222/Fax: (86) 21-5037-2200

Authorized Distributor:

© OMRON Corporation 2010 All Rights Reserved.
In the interest of product improvement,
specifications are subject to change without notice.

CSM_4_1
Cat. No. G019-E1-02

0412(0710)(O)

X-ON Electronics

Largest Supplier of Electrical and Electronic Components

Click to view similar products for [Circular Metric Connectors](#) category:

Click to view products by [Omron](#) manufacturer:

Other Similar products are found below :

[600X518037X](#) [6STD15PCR99B70A](#) [8R4000A16M020](#) [8R5000A16M005](#) [1200910002](#) [1203580030](#) [1200910008](#) [1200910011](#) [1300140094](#)
[130203-0054](#) [1300140026](#) [1300150099](#) [RF-12S1N8A90DU](#) [1-3637-600-5205](#) [1612618](#) [21036836414](#) [8R4006A16M010](#) [1604232](#)
[1R3006A20M005](#) [RF-12P1N8A90DU](#) [41-40011](#) [42-00006](#) [42-01015](#) [4-22279-4](#) [4-22281-1](#) [4-22284-9](#) [43-00113](#) [43-01088](#) [43-01203](#) [41-](#)
[40013](#) [42-00008](#) [43-00343](#) [43-01026](#) [43-01162](#) [43-01173](#) [43-10000](#) [XS3P-M421-2](#) [600X518050X](#) [SACC-DSI-FS-5P-PG9-L180 SC](#)
[8R5006A16M020](#) [8R5006A16M005](#) [8R4000A16M010](#) [6-22279-3](#) [1605332](#) [N03FA03144](#) [1300140077](#) [43-16213](#) [43-01338](#) [XS2RD4265](#)
[XS2R-D426-1](#)