

# Industrial Ethernet Cables

## XS5/XS6

### Cables and Connectors for EtherCAT® and Other Industrial Ethernet Networks

**CAT6a Ethernet patch cables**

- For in-cabinet use
- LSZH with standard RJ45 plugs

**CAT5e Ethernet patch cables**

- For out-of-cabinet use
- PUR with standard RJ45 plugs
- PVC with rugged RJ45 plugs
- PVC with M12 SmartClick plugs



**Connection Examples**

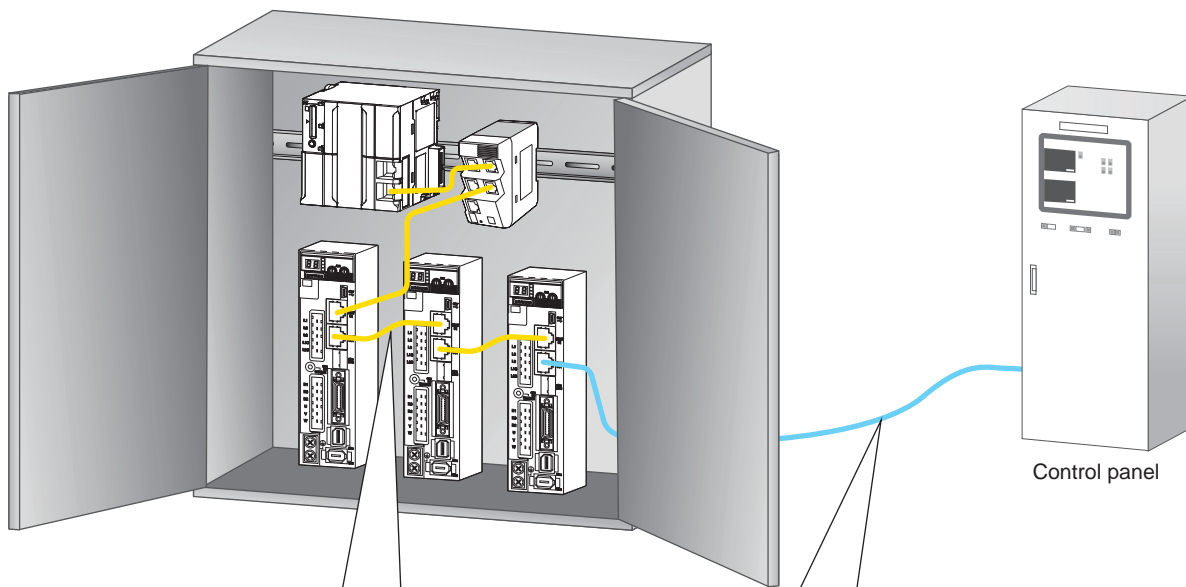

Ideal for in-cabinet  
XS6W-6LSZH

Standard Connectors

Ideal for out-of-cabinet  
XS6W-5PUR

XS5

Standard Connectors | Rugged Connectors | M12 Connectors | M12 Connectors

## ■ Features

### Cables with Standard RJ45 Connectors

Refer to page 3 for details.

- The lineup features LSZH cables\* for in-panel wiring and PUR cables for wiring outside of panels.
- The Standard RJ45 Connectors reduce cable routing space.
  - Outer diameter: 5.8 mm
  - 4-pair AWG27 (LSZH) or AWG26 (PUR)
- Cable colors include blue, yellow, or green.
- LSZH cables are available in 12 lengths from 0.2 to 20 m and PUR cables are available in 10 lengths from 0.5 to 20 m.
- Double-shielded cables with overall braiding and individual foil shield on each wire pair to reduce EMC interference in industrial environments.

\* Low-smoke zero-halogen cables.

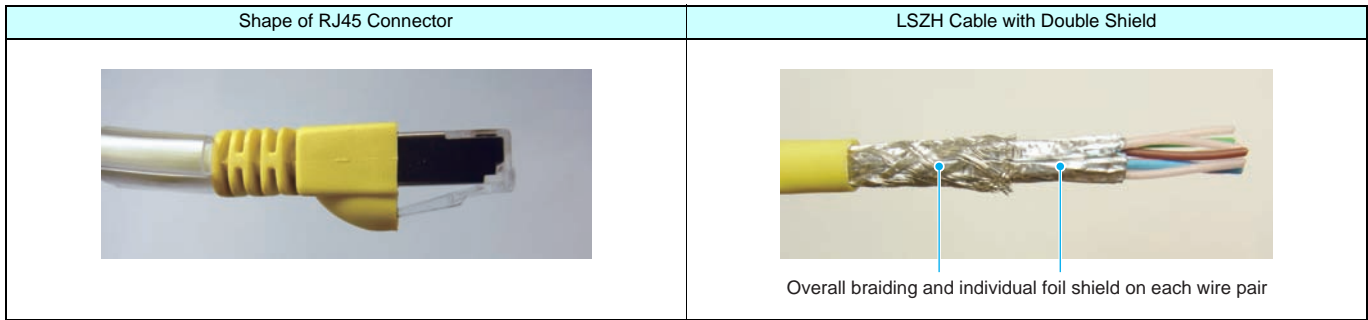

### Cables with Rugged RJ45 Connectors

Refer to page 5 for details.

- Tough latches and RJ45 connectors with strong cable holding strength are used to enable connections outside of control panels.
- Quad AWG22 cable with PVC cover of 6.5 mm outer diameter.
- Double-shielded cables with overall braiding and individual foil shield to reduce EMC interference in industrial environments.

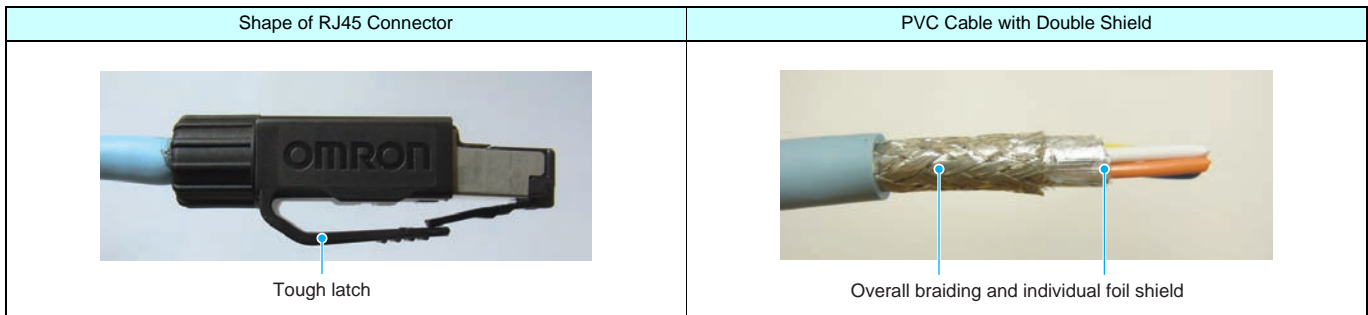

### ● Cable Extension Length

#### Standard Connectors (RJ45 Connectors)

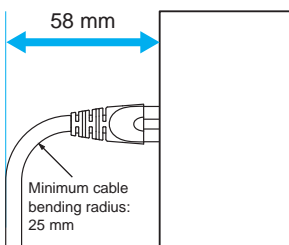

#### Rugged Connectors (RJ45 Connectors)

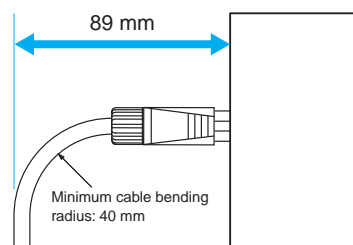

### Cables with M12 Connectors





Refer to page 5 for details.

- Resistance to harsh environments with IP67 protection.
- SmartClick Connectors that provide one-step (1/8th turn) connection are used (compatible with standard M12 screw connectors).
- A wide range of variations, such as cables with right-angle connectors and PCB connectors.

• SmartClick is registered trademark of OMRON Corporation.  
 • EtherCAT® is a registered trademark and patented technology, licensed by Beckhoff Automation GmbH, Germany.

## Cables with Standard RJ45 Connectors

### Ordering Information

Appearance	Type	Category	Cable sheath material	Cable color	Cable length (m)	Model
	Cable with Connectors on Both Ends (RJ45/RJ45)	Cat.6a	LSZH	Blue	0.2	XS6W-6LSZH8SS20CM-B
					0.3	XS6W-6LSZH8SS30CM-B
					0.5	XS6W-6LSZH8SS50CM-B
					1	XS6W-6LSZH8SS100CM-B
					1.5	XS6W-6LSZH8SS150CM-B
					2	XS6W-6LSZH8SS200CM-B
					3	XS6W-6LSZH8SS300CM-B
					5	XS6W-6LSZH8SS500CM-B
					7.5	XS6W-6LSZH8SS750CM-B
					10	XS6W-6LSZH8SS1000CM-B
					15	XS6W-6LSZH8SS1500CM-B
					20	XS6W-6LSZH8SS2000CM-B
				Yellow	0.2	XS6W-6LSZH8SS20CM-Y
					0.3	XS6W-6LSZH8SS30CM-Y
					0.5	XS6W-6LSZH8SS50CM-Y
					1	XS6W-6LSZH8SS100CM-Y
					1.5	XS6W-6LSZH8SS150CM-Y
					2	XS6W-6LSZH8SS200CM-Y
					3	XS6W-6LSZH8SS300CM-Y
					5	XS6W-6LSZH8SS500CM-Y
					7.5	XS6W-6LSZH8SS750CM-Y
					10	XS6W-6LSZH8SS1000CM-Y
					15	XS6W-6LSZH8SS1500CM-Y
					20	XS6W-6LSZH8SS2000CM-Y
	Green	0.2	XS6W-6LSZH8SS20CM-G			
		0.3	XS6W-6LSZH8SS30CM-G			
		0.5	XS6W-6LSZH8SS50CM-G			
		1	XS6W-6LSZH8SS100CM-G			
		1.5	XS6W-6LSZH8SS150CM-G			
		2	XS6W-6LSZH8SS200CM-G			
		3	XS6W-6LSZH8SS300CM-G			
		5	XS6W-6LSZH8SS500CM-G			
		7.5	XS6W-6LSZH8SS750CM-G			
		10	XS6W-6LSZH8SS1000CM-G			
		15	XS6W-6LSZH8SS1500CM-G			
		20	XS6W-6LSZH8SS2000CM-G			
	Green	Cat.5	PUR	0.5	XS6W-5PUR8SS50CM-G	
				1	XS6W-5PUR8SS100CM-G	
				1.5	XS6W-5PUR8SS150CM-G	
				2	XS6W-5PUR8SS200CM-G	
				3	XS6W-5PUR8SS300CM-G	
				5	XS6W-5PUR8SS500CM-G	
				7.5	XS6W-5PUR8SS750CM-G	
				10	XS6W-5PUR8SS1000CM-G	
				15	XS6W-5PUR8SS1500CM-G	
				20	XS6W-5PUR8SS2000CM-G	

## Specifications

Item	Type	Cable with Connectors on Both Ends (RJ45/RJ45)/LSZH	Cable with Connectors on Both Ends (RJ45/RJ45)/PUR
	Model	XS6W-6LSZH8SS□□□□CM-□	XS6W-5PUR8SS□□□□CM-G
Rated current		1 A (at 50°C)	
Withstand voltage		1,000 VDC for 60 s (leakage current: 1 mA max.)	
Ambient operating temperature		-20 to 60°C	-40 to 85°C
Ambient storage temperature		-20 to 60°C	-40 to 85°C
Ambient installation temperature		0 to 50°C	-10 to 60°C
Protective structure		IP20	IP20

## Materials and Finish

### Connectors

Item	Type	Cable with Connectors on Both Ends (RJ45/RJ45)/LSZH	Cable with Connectors on Both Ends (RJ45/RJ45)/PUR
	Model	XS6W-6LSZH8SS□□□□CM-□	XS6W-5PUR8SS□□□□CM-G
Connector housing		PC resin (UL94V-0)/transparent	
Contacts		Phosphor bronze/nickel base, gold plated (0.8 μm)	
Shield		Brass/nickel plated	
Cover (structured to prevent the tab from breaking)		LSZH: Blue, yellow, or green	PUR: Green
Marking tube		PVC resin (UL94V-0)/transparent	

### Cables

Item	Type	Cable with Connectors on Both Ends (RJ45/RJ45)/LSZH	Cable with Connectors on Both Ends (RJ45/RJ45)/PUR
	Model	XS6W-6LSZH8SS□□□□CM-□	XS6W-5PUR8SS□□□□CM-G
Compliant standard		IEC 60332-1 /UL1581 FT2	
Number of cores/gauge		4x2xAWG27 0.1 mm <sup>2</sup>	4x2xAWG26 0.13 mm <sup>2</sup>
Outer diameter*1		5.8 mm	
Sheath color*2		Blue, yellow, or green	Green
Sheath material		LSZH	PUR
Shield structure		Double shield S/FTP	Double shield SF/UTP

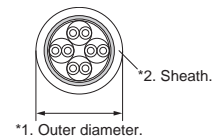

## Dimensions

(Unit: mm)

### Cable with Connectors on Both Ends (RJ45/RJ45)

XS6W-6LSZH8SS□□□□CM-□

XS6W-5PUR8SS□□□□CM-G

### Wiring



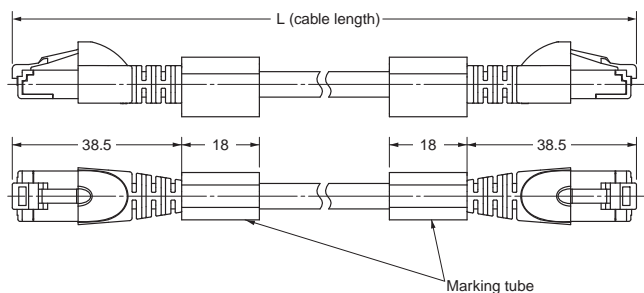
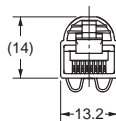







RJ45	1	RJ45	1
	2		2
	3		3
	4		4
	5		5
	6		6
	7		7
	8		8
Shield		Shield	



Note. External dimensions are the same for all cable materials.

Cables with Rugged RJ45 Connectors and Cables with M12 Connectors

Ordering Information

Appearance	Type		Cable length (m)	Model
	Cable with Connector on One End (M12 Straight)		0.5	XS5H-T421-BM0-K
			1	XS5H-T421-CM0-K
			2	XS5H-T421-DM0-K
			3	XS5H-T421-EM0-K
			5	XS5H-T421-GM0-K
			10	XS5H-T421-JM0-K
			15	XS5H-T421-KM0-K
	Cable with Connectors on Both End (M12 Straight/M12 Straight)		0.5	XS5W-T421-BM2-K
			1	XS5W-T421-CM2-K
			2	XS5W-T421-DM2-K
			3	XS5W-T421-EM2-K
			5	XS5W-T421-GM2-K
			10	XS5W-T421-JM2-K
			15	XS5W-T421-KM2-K
	Cable with Connectors on Both Ends (M12 Straight/RJ45)		0.3	XS5W-T421-AMC-K
			0.5	XS5W-T421-BMC-K
			1	XS5W-T421-CMC-K
			2	XS5W-T421-DMC-K
			3	XS5W-T421-EMC-K
			5	XS5W-T421-GMC-K
			10	XS5W-T421-JMC-K
15	XS5W-T421-KMC-K			
	Cable with Connector on One End (M12 Right-angle)		0.5	XS5H-T422-BM0-K
			1	XS5H-T422-CM0-K
			2	XS5H-T422-DM0-K
			3	XS5H-T422-EM0-K
			5	XS5H-T422-GM0-K
			10	XS5H-T422-JM0-K
			15	XS5H-T422-KM0-K
	Cable with Connectors on Both Ends (M12 Right-angle/M12 Right-angle)		0.5	XS5W-T422-BM2-K
			1	XS5W-T422-CM2-K
			2	XS5W-T422-DM2-K
			3	XS5W-T422-EM2-K
			5	XS5W-T422-GM2-K
			10	XS5W-T422-JM2-K
			15	XS5W-T422-KM2-K
	Cable with Connectors on Both Ends (M12 Right-angle/RJ45)		0.3	XS5W-T422-AMC-K
			0.5	XS5W-T422-BMC-K
			1	XS5W-T422-CMC-K
			2	XS5W-T422-DMC-K
			3	XS5W-T422-EMC-K
			5	XS5W-T422-GMC-K
			10	XS5W-T422-JMC-K
15	XS5W-T422-KMC-K			
	Cable with Connectors on Both Ends (RJ45/RJ45)		0.3	XS5W-T421-AMD-K
			0.5	XS5W-T421-BMD-K
			1	XS5W-T421-CMD-K
			2	XS5W-T421-DMD-K
			3	XS5W-T421-EMD-K
			5	XS5W-T421-GMD-K
			10	XS5W-T421-JMD-K
15	XS5W-T421-KMD-K			
	RJ45 Assembly Connector		---	XS6G-T421-1
	M12 Connector for Panel Mounting	Rear locking	0.5	XS5P-T426-5
		Front locking	0.5	XS5P-T427-5
	M12 Panel-mounting PCB Straight Terminals		---	XS5P-T426-1

## Specifications

Type	Cable with Connector on One End (M12)	Cable with Connectors on Both Ends (M12/M12)	Cable with Connectors on Both Ends (M12/RJ45)	Cable with Connectors on Both Ends (RJ45/RJ45)	RJ45 Assembly Connector	M12 Connector for Panel Mounting	M12 Panel-mounting PCB Straight Terminals
Item Model	XS5H -T42□-□M0-K	XS5W -T42□-□M2-K	XS5W -T42□-□MC-K	XS5W -T421-□MD-K	XS6G -T421-1	XS5P-T42□-5	XS5P-T426-1
Rated current	3 A		2.5 A		4 A		
Rated voltage	30 V					125 VDC	
Contact resistance	40 mΩ max.						
Insulation resistance	1,000 MΩ min.			500 MΩ min.		1,000 MΩ min.	
Withstand voltage	1,000 VAC for 60 s (leakage current: 1 mA max.)					1,500 VAC for 60 s (leakage current: 1 mA max.)	
Ambient operating temperature	-25 to 70°C						
Ambient storage temperature	-25 to 70°C						
Protective structure	M12: IEC IP67, RJ45: IEC IP20						IEC IP67

## Materials and Finish

### Connectors

Item	Model	M12			RJ45
		XS5H and XS5W	XS5P-T42□-5	XS5P-T426-1	XS5W and XS6G
Contact blocks		PBT resin (UL94V-0)/light gray	PBT resin (UL94V-0)/light gray	PA resin (UL94V-0)/black	PC resin (UL94V-0)/black
Contacts		Phosphor bronze/nickel base, gold plated (0.4 μm)	Phosphor bronze/nickel base, gold plated (0.4 μm)	Bronze/nickel base, gold plated (0.4 μm)	Phosphor bronze/nickel base, gold plated (1.4 μm)
Anchors		Zinc diecast/nickel plating	Zinc diecast/nickel plating	Zinc diecast/nickel plating	---
Anchors (tabs)		SUS	---	---	---
Cover		Straight connector: Soft PBT resin (UL94V-0)/black Right-angle connector: TPC resin/black	---	---	---
Sealing resin		---	Epoxy resin	---	---
O-rings		Rubber	Rubber	Rubber	---
Grounding fixture		---	---	Phosphor bronze/nickel base, tin plated (2.0 μm)	---
Anchor cover		---	---	SUS	---
Nuts		---	Bronze/nickel plated	Bronze/nickel plated	---

### Cables

Compliant standard	UL CM
Category	Category 5e
Number of cores/color	AWG22 (7/0.26): Yellow, orange, white, and blue
Outer diameter*1	6.5 dia.
Sheath color*2	Light gray
Sheath material	PVC
Shield structure	Double shield SF/UTP

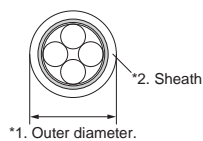

\*1. Outer diameter.

Note. For the XS5H and XS5W, cables are available only with connectors attached.

## ■ Dimensions

(Unit: mm)

### ● Cable with Connector on One End (M12 Straight) XS5H-T421-□M0-K

#### Wiring

Terminal No.	Color
1	Yellow
2	White
3	Orange
4	Blue

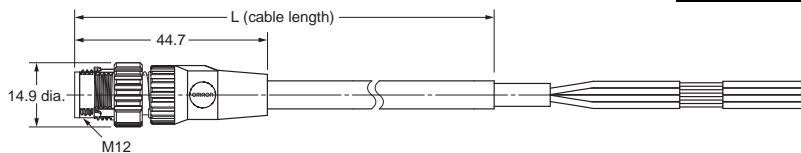

### ● Cable with Connectors on Both End (M12 Straight/M12 Straight) XS5W-T421-□M2-K

#### Wiring

M12 straight	M12 straight
1	1
2	2
3	3
4	4
Shield	Shield

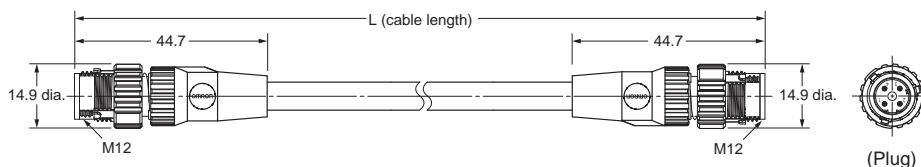

### ● Cable with Connectors on Both Ends (M12 Straight/RJ45) XS5W-T421-□MC-K

#### Wiring

M12 straight	RJ45
1	1
2	3
3	2
4	6
Shield	Shield

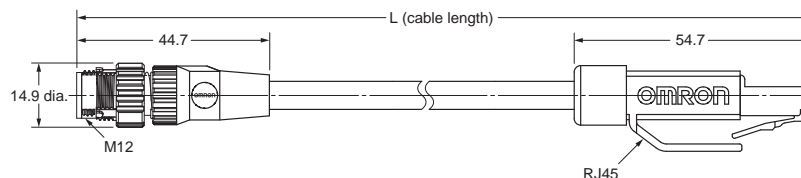

● Cable with Connector on One End (M12 Right-angle)  
XS5H-T422-□M0-K

Wiring

Terminal No.	Color
1	Yellow
2	White
3	Orange
4	Blue

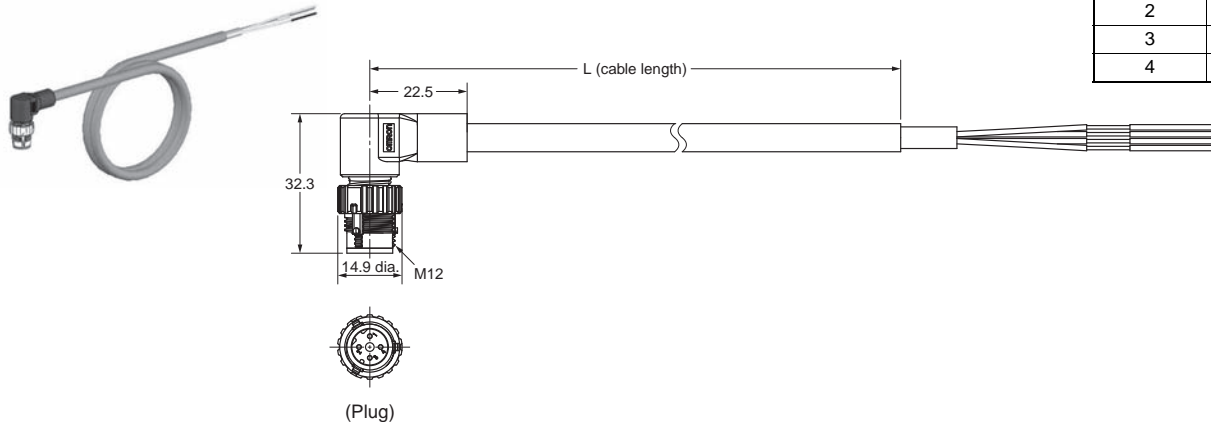

● Cable with Connectors on Both Ends (M12 Right-angle/M12 Right-angle)  
XS5W-T422-□M2-K

Wiring

M12 right angle	M12 right angle
1	1
2	2
3	3
4	4
Shield	Shield

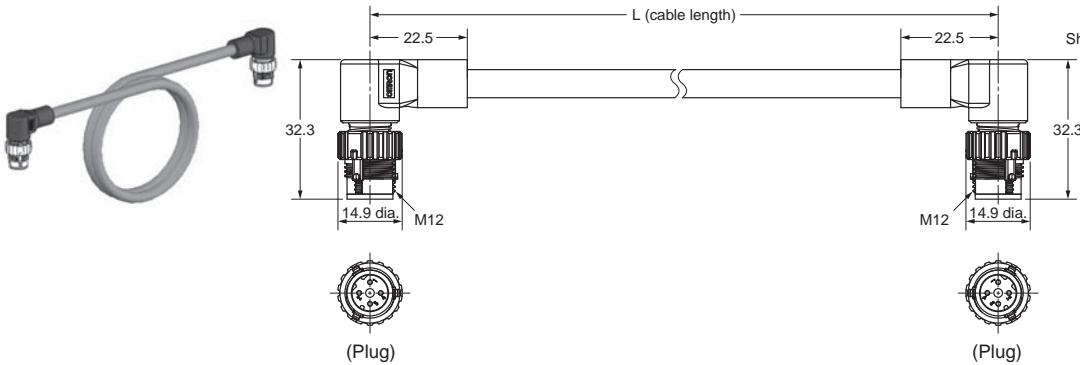

● Cable with Connectors on Both Ends (M12 Right-angle/RJ45)  
XS5W-T422-□MC-K

Wiring

M12 right angle	RJ45
1	1
2	3
3	2
4	6
Shield	Shield

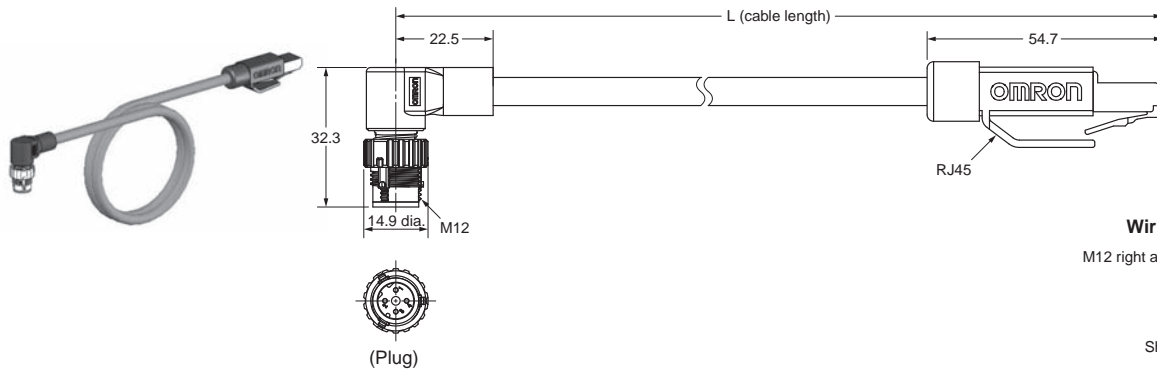

● Cable with Connectors on Both Ends (RJ45/RJ45)  
XS5W-T421-□MD-K

Wiring

RJ45	RJ45
1	1
2	2
3	3
6	6
Shield	Shield

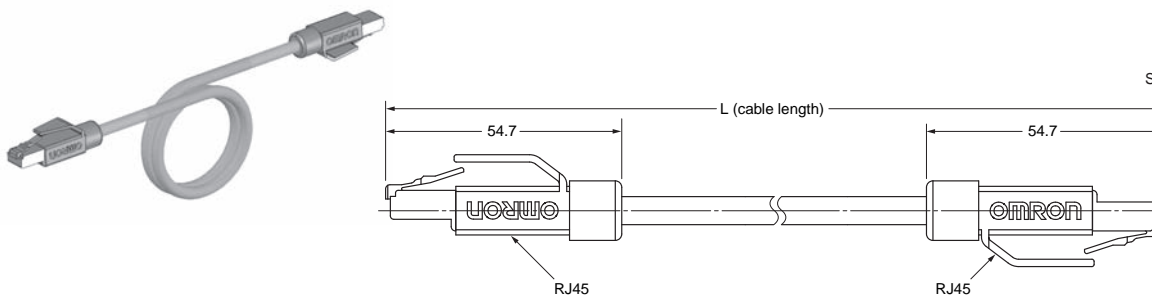



● **Assembly Connector (RJ45)**  
XS6G-T421-1

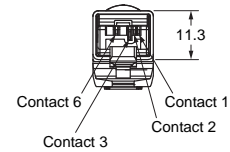
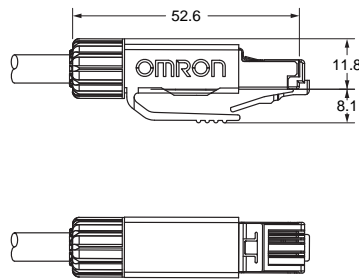

**Applicable wires**  
Sheath outer diameter: 6.1 to 6.9 mm  
Core size: AWG22 to AWG24 (stranded wires)  
AWG22 to AWG23 (solid wires)  
Insulation outer diameter: 1.6 mm max.

● **M12 Connector for Panel Mounting**  
XS5P-T42□-5



**XS5P-T426-5 (Rear Locking)**

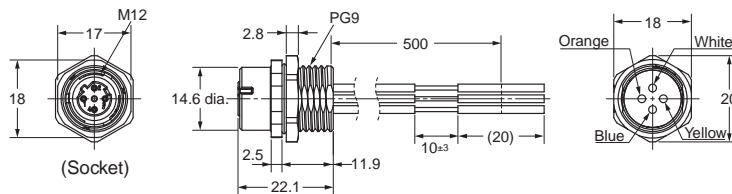

**XS5P-T427-5 (Front Locking)**

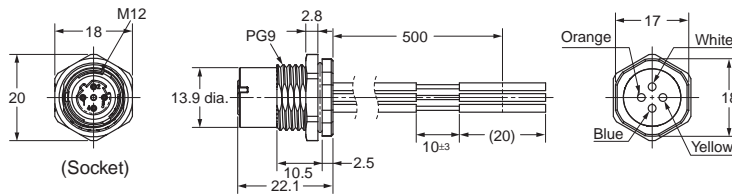

**Wiring**

Terminal No.	Color
1	Yellow
2	White
3	Orange
4	Blue

**Panel Cutout Dimension**

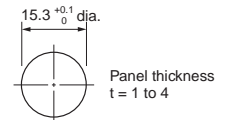

Note 1: The panel cutout dimension is the same for Front-locking and Rear-locking Connectors.  
Note 2: Rotational positioning is not possible for connector rotation.

● **Panel-mounting PCB Straight Terminals (M12)**  
XS5P-T426-1

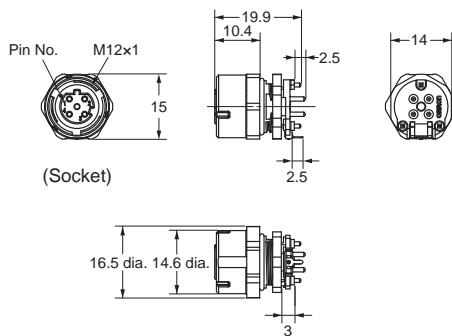

**Mounting Hole Dimensions (D Cut Structure)**

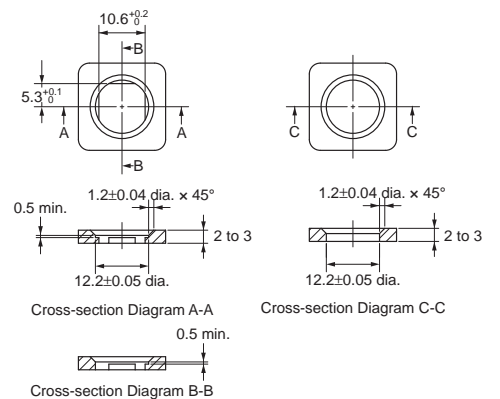

**Panel Processing Dimensions**

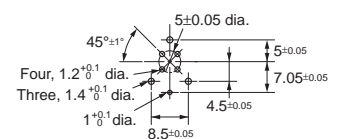

## Assembly Procedure

### ● RJ45 Assembly Connectors

#### XS6G-T421-1

1. Pass the cable through the cable clamp and the connector housing
2. Strip the cable sheath and ground braiding to the correct lengths.
3. Follow the color codes and prepare to insert the wires into the splice piece.
4. Insert the wires into the splice piece for the length of the splice piece.
5. Place the splice piece into the RJ45 data module and engage it.
6. Place the data module and the splice piece on the IDC assembly housing.
7. Press the data module and the IDC assembly housing together and use pliers or a similar device to make the insulation displacement contact.
8. Remove the data module from the IDC assembly housing.
9. Place the upper screen plate on the data module and press it over the ground braiding of the cable.
10. Place the lower screen plate on the bottom of the data module, align it with the upper screen plate, and latch it until you hear it click into place.
11. Slide the housing that you placed around the cable in step 1 up to the data module and latch it until you hear it click into place.
12. Tighten the cable clamp.



### Pin Assignments

Pin Assignments for Fast Ethernet 10/100 Mbps

Function/Signal	Wire color			Pin No.
	Industrial Ethernet	EIA/TIA 568A	EIA/TIA 568B	
Transmission Data+/TD+	YE	WH/GN	WH/OG	1
Transmission Data-/TD-	OG	GN	OG	2
Receiver Data/RD+	WH	WH/OG	WH	3
Receiver Data/RD-	BU	OG	GN	6

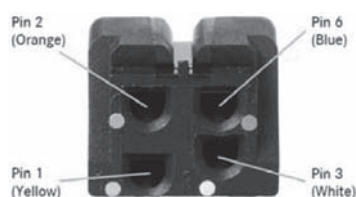

### ● M12 Panel-mounting PCB Straight Terminals

#### XS5P-T426-1

#### Confirming the Number of Parts

The following four parts are included in the package when it is delivered.

#### Panel-mounting Parts

1. Anchor

2. O-Ring

3. Nut

#### PCB-mounting Part

4. Connector



#### Assembly Procedure

1. Mount the connector to the PCB.
2. Attach the anchor to the panel with the nut.

Mounting the Connector to the PCB

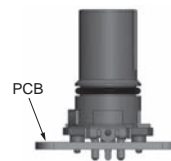

Mounting the Anchor to the Panel

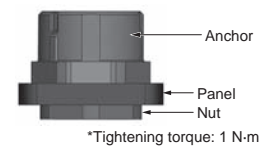

3. Attach the connector that you mounted to the PCB to the panel.

\* Make sure that the connector and anchor are oriented correctly.

Attachment

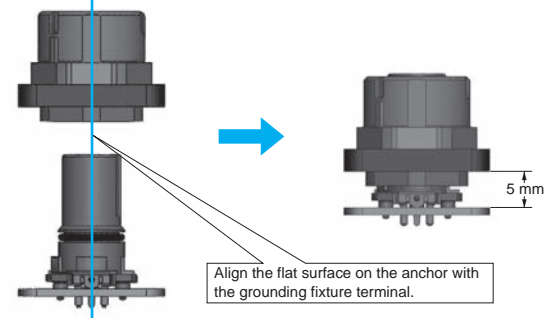

4. Temporarily mount the O-ring to the top of the connector at the mating surface.

Temporary Mounting of the O-Ring

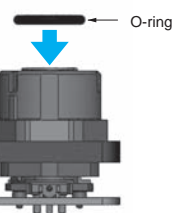

5. Mate the Connector Waterproof Cover (XS2Z-22, sold separately) or the Partner Connector Plug (XS5H-T42□-□M0-K, sold separately) and press the O-ring to the O-ring position after mounting.

Mounting the O-Ring

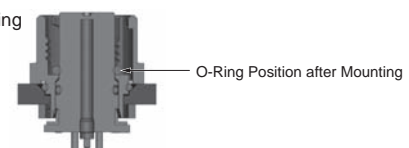

### ● Connector Waterproof Cover (Sold Separately)

#### XS2Z-22

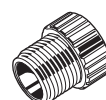

\* Tightening torque: 0.39 to 0.49 N·m

## ■ Safety Precautions

### Precautions for Correct Use

Do not use the Connectors in an atmosphere or environment that exceeds the specifications.

#### ● Connector Connection and Disconnection

- When connecting or disconnecting Connectors, be sure to hold the Connectors.
- Do not hold the cable when disconnecting Connectors.
- When joining Connectors, be sure to insert the plug all the way to the back of the socket before attempting to lock the Connectors.
- Do not use tools of any sort to join the Connectors. Always use your hands. Pliers or other tools may damage the Connectors.

#### ● Wiring

Lay the cables so that external force is not applied to the Connectors. Otherwise, the degree of protection (IP67) may not be achieved.

#### ● Degree of Protection for M12/Smartclick Connectors

- The degree of protection of Connectors (IP67) is not for a fully watertight structure. Do not use the Connectors underwater.
- Do not step on or place any objects on the Connectors. Doing so may damage the Connectors.

#### ● Handling Precautions

- Do not pull on the Connectors or cables with excessive force.  
Do not install the Connectors with a load placed directly on the joint or at the point where the wires connect to the Connector. The Connector may be damaged or the wires in the cable may be disconnected.
- Lay the cable where it will not be stepped on to prevent the wires in the cable from being disconnected and to protect the Connectors from being damaged. If the cable must be placed where it will be stepped on, install a protective cover.
- When bending cables, do not exceed the cable specifications.

- Application examples provided in this document are for reference only. In actual applications, confirm equipment functions and safety before using the product.
- Consult your OMRON representative before using the product under conditions which are not described in the manual or applying the product to nuclear control systems, railroad systems, aviation systems, vehicles, combustion systems, medical equipment, amusement machines, safety equipment, and other systems or equipment that may have a serious influence on lives and property if used improperly. Make sure that the ratings and performance characteristics of the product provide a margin of safety for the system or equipment, and be sure to provide the system or equipment with double safety mechanisms.

**OMRON Corporation Industrial Automation Company**

Tokyo, JAPAN

Contact: [www.ia.omron.com](http://www.ia.omron.com)

**Regional Headquarters**

**OMRON EUROPE B.V.**

Wegalaan 67-69-2132 JD Hoofddorp  
The Netherlands

Tel: (31)2356-81-300/Fax: (31)2356-81-388

**OMRON ELECTRONIC COMPONENTS LLC**

55 Commerce Drive, Suite B,  
Shaumburg, IL, 60173, U.S.A.

Tel: (1) 847-882-2288/Fax: (1) 847-882-2192

**OMRON ASIA PACIFIC PTE. LTD.**

No. 438A Alexandra Road # 05-05/08 (Lobby 2),  
Alexandra Technopark,  
Singapore 119967

Tel: (65) 6835-3011/Fax: (65) 6835-2711

**OMRON (CHINA) CO., LTD.**

Room 2211, Bank of China Tower,  
200 Yin Cheng Zhong Road,  
PuDong New Area, Shanghai, 200120, China

Tel: (86) 21-5037-2222/Fax: (86) 21-5037-2200

**Authorized Distributor:**

© OMRON Corporation 2010 All Rights Reserved.  
In the interest of product improvement,  
specifications are subject to change without notice.

**Cat. No. G019-E1-04**

0213(0710)(O)

## X-ON Electronics

Largest Supplier of Electrical and Electronic Components

*Click to view similar products for [Ethernet Cables / Networking Cables](#) category:*

*Click to view products by [Omron](#) manufacturer:*

Other Similar products are found below :

[73-6670-7](#) [73-6680-15](#) [73-7797-25](#) [MCJB2-10P6Q7-120](#) [84909-0204](#) [1200700174](#) [1200860368](#) [E16A06002M030](#) [E200102-009-S1](#)  
[AX105346-EW](#) [MT14-187L](#) [17-103530](#) [ERWPAB3002M005](#) [190-038045-01](#) [NK5EPC18RDY](#) [NK5EPC18VLY](#) [NK5EPC18YLY](#)  
[NK5EPC1GRY](#) [NK5EPC4Y](#) [NK5EPC6YLY](#) [NK5EPC8BLY](#) [NK5EPC9YLY](#) [1969343-6](#) [C501100010](#) [C501106002](#) [C501106007](#)  
[C501106015](#) [C501106025](#) [C601102010](#) [C601104010](#) [C601106007](#) [C601106015](#) [2142758-2](#) [2168427-2](#) [CAT1106007](#) [21949-1](#) [2J1866A](#)  
[RJF SFTP 5E 0500](#) [AX100351](#) [MN14CEC/ST](#) [C501100015](#) [C501106004](#) [C501106010](#) [C5F1108007](#) [C601104004](#) [C601106004](#)  
[CA21106004](#) [CA21106010](#) [CA21106015](#) [CA21109007](#)