

Microwave RFID System Provides Long-distance Transmission up to 2 m

- Data is transmitted by 2,450-MHz microwave signals, thus enabling a transmission distance of up to 2 m coupled with superior noise resistance
- Data Carrier conforms to IEC 60529 IP67 and the R/W Antenna satisfies IP66 for superior environmental resistance
- Large-capacity 8K-byte memory stores assembly information, inspection information, and classification information as well as product information in the production line
- Low battery detection function is provided



Ordering Information

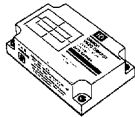

■ Data Carriers

Item	Part number		Specifications/Design
Built-in-battery DC	V620-D8KR01		IEC 60529 IP67 Dimensions: 86 × 54 × 23.5 mm Built-in lithium battery 8K-byte memory

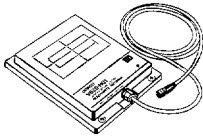
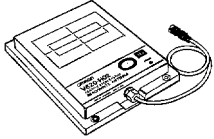

■ R/W Antennas

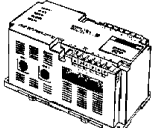
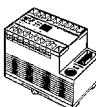
Type	Part number		Specifications/Design
2-m Transmission	V620-H01 (0.5 m)		Dimensions: 240 × 190 × 41 mm
	V620-H01 (10 m)		0.5-m cable 10-m cable
0.5-m Transmission	V620-H02 (0.5 m)		Dimensions: 240 × 190 × 41 mm
	V620-H02 (10 m)		0.5-m cable 10-m cable

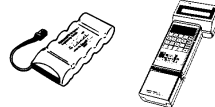
■ ID Controllers

Type	Part number		Specifications/Design	
AC Power Supply	V620-CA1A		100 to 240 VAC, 50/60 Hz Two R/W antenna connectors Dimensions: 200 × 100 × 100 mm	RS-232C host interface
	V620-CA2A			RS-422 host interface
	V620-CA8A			Parallel PNP host interface
	V620-CA9A			Parallel NPN host interface
DC Power Supply	V620-CD1D		24 VDC R/W antenna connectors Dimensions: 165 × 68 × 80 mm	RS-232C host interface
Handheld	V620-CB-US-S (Kit)		A Battery Charger, Ni-Cd Battery Pack, Battery Case, and Carrying Belt are included	
	V620-CB-US-S1 (Kit)		Ni-cd Battery, Battery Case, and Carrying Belt are included	

■ ID Sensor Units/ID Adapters

Part number		Specifications		
C500-IDS21	ID Sensor Unit		SYSMAC CV500, CV1000, CVM1, C500(F), C1000H(F), C2000H PLCs	General-purpose
C500-IDS22				Long-distance transmission
C200H-IDS21				General-purpose
C500-IDA22	ID Adapter		Required when using the C500-IDS22 ID Sensor Unit	Long-distance transmission

■ Accessories (Order Separately)

Item	Part number		Specifications/Design	
Extension Cable	V620-A40		Standard cable (Connectors are not water-resistant.)	10 m
	V620-A41			20 m
	V620-A42			30 m

■ RS-232C Cables (Order Separately)

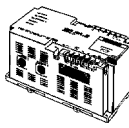
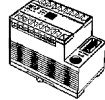
Part number	Cable length	Applicable ID Controller	
XW2Z-200P	2 m	V620-CA1A	
XW2Z-500P	5 m		
XW2Z-200S	2 m	V620-CD1D	
XW2Z-500S	5 m		

■ ID Controller Communications Connectors

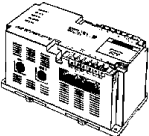
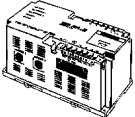
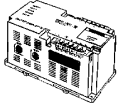
Part number	Name	Applicable ID Controller
XM2A-0901	Connector Plug	V620-CA2A V620-CD1D 
XM2S-0911	Connector Hood	
XM2A-2501	Connector Plug	V620-CA1A 
XM2S-2511	Connector Hood	
MR-50F (Honda Tsushin Kogyo)	Connector Plug	V620-CA8A V620-CA9A 
MR-50L (Honda Tsushin Kogyo)	Connector Hood	

System Configuration

Host System

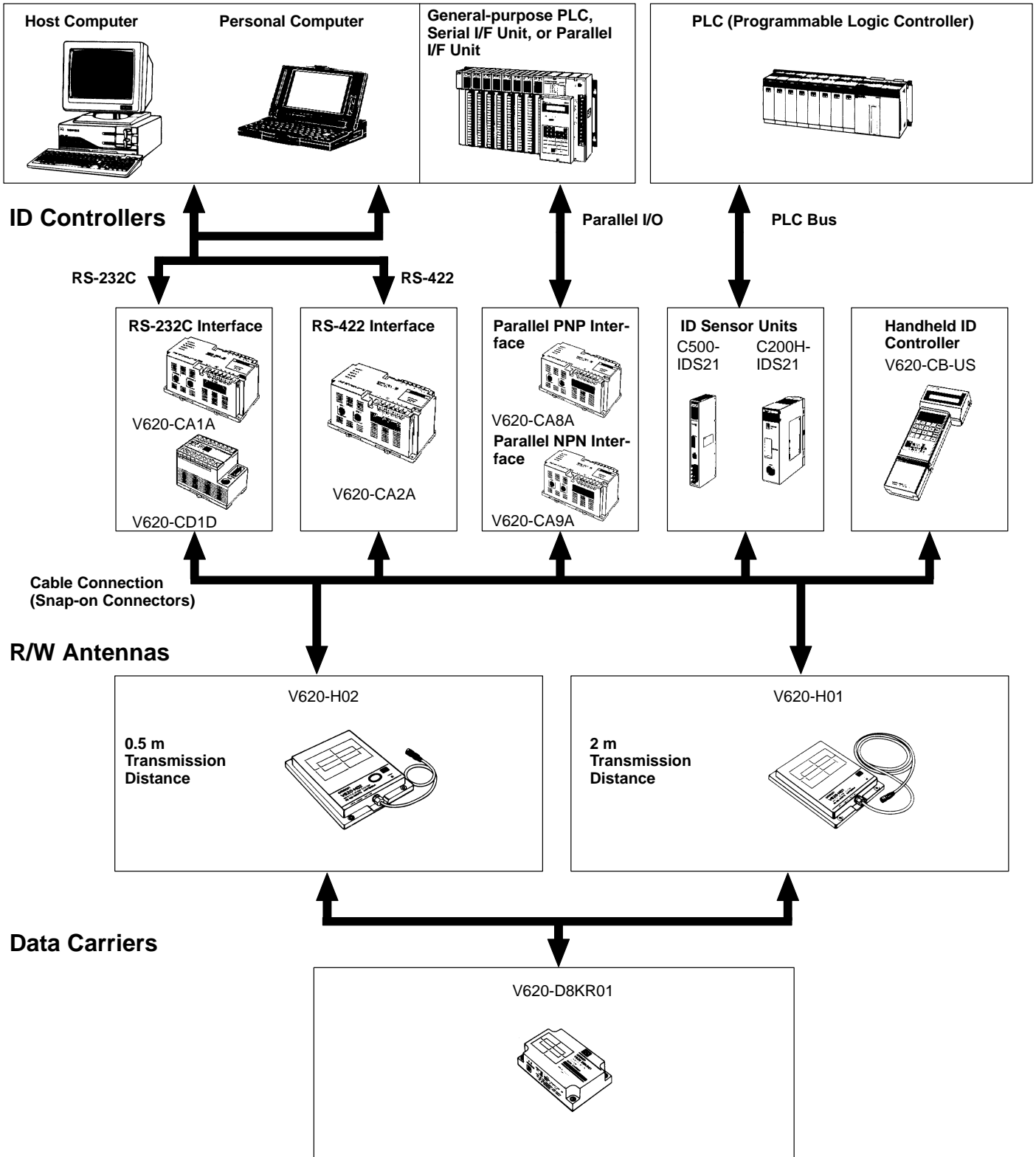

Specifications

■ Data Carriers

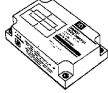
Item	V620-D8KR01 
Memory Capacity	8K byte
Battery life (see note)	Refer to <i>Battery Life vs. Amount of Data Transferred</i> below
Ambient temperature	Operating: -25° to 70°C
Ambient humidity	Operating: 35% to 95%
Protection ratings	IEC 60529 IP67
Vibration resistance	Destruction: 10 to 55 Hz, 1.5-mm double-amplitude for 2 hrs each in X, Y, and Z directions
Shock resistance	Destruction: 500 m/s ² (approx. 50G) for 3 times each in X, Y, and Z directions
Weight	Approx. 120 g

Note: A low battery detection function is built-in.

■ Read/Write (R/W) Antenna

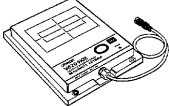
Item	V620-H01 	V620-H02 
Transmission frequency	2,450 MHz	
Antenna's supply power	3 mW max.	1 mW max.
Transmission beam width	±23°C (antenna gain: 12 dB)	±20°C (antenna gain: 13 dB)
Ambient temperature	Operating: -25° to 70°C	
Ambient humidity	Operating: 35% to 95%	
Insulation resistance	50 MΩ (at 500 VDC) between cable terminals and case	
Dielectric strength	500 VAC, 50/60 Hz for 1 min between cable terminals and case	
Protection ratings	IEC 60529 IP66	
Vibration resistance	Destruction: 10 to 55 Hz, 1.5-mm double amplitude for 2 hrs each in X, Y, and Z directions	
Shock resistance	Destruction: 500 m/s ² (approx. 50G) for 3 times each in X, Y, and Z directions (18 times total)	
Cable length (see note 2)	Standard lengths of 0.5 m and 10 m	
Weight	Approx. 2 kg (with 10-m cable, the R/W Antenna itself weighs 1.4 kg max.)	

Note: 1. Connectors are not water-resistant.

2. Various intermediate lengths of cable are available. (Total cable length: 30.5 m max.)

■ ID Controllers

Item	V620-CA1A	V620-CA2A	V620-CA8A	V620-CA9A	V620-CD1D
Host interface	RS-232C	RS-422 (Max. of 16 Units can be connected.)	Parallel PNP output	Parallel NPN output	RS-232C
Possible number of R/W Antennas	2				1
Power supply voltage	100 to 240 VAC, 50/60 Hz				24 VDC
Acceptable power supply voltage	85 to 264 VAC				20.4 to 26.4 VDC
Power consumption	35 VA max.				7.2 W max.
Insulation resistance	50 MΩ min. (at 500 VDC) between power terminals and case, between I/O terminals and case, or between the power supply terminals and I/O terminals				
Dielectric strength	1,500 VAC, 50/60 Hz for 1 min between the points listed above; Leakage current: 10 mA max.				1,000 VAC, 50/60 Hz for 1 min between the points listed above. Leakage current: 10 mA max.
Noise immunity	1,500 V (p-p) pulses of 100 ns to 1 μs pulse width with a 1 ns rise time				
Vibration resistance	Destruction: 10 to 150 Hz, 0.3-mm double amplitude for 32 min each in X, Y, and Z directions Malfunction: 10 to 150 Hz, 0.2-mm double amplitude for 32 min each in X, Y, and Z directions				
Shock resistance	Destruction: 200 m/s ² (approx. 20G) for 3 times each in X, Y, and Z directions				
Ambient temperature	Operating: -10° to 55°C Storage: -25° to 65°C				
Ambient humidity	Operating: 35% to 85% (with no condensation)				
Operating conditions	No corrosive gases				
Memory back-up	A capacitor backs up the most recent error data and statistical error data for up to 20 days (at 25°C) after a power interruption				Memory is not backed up, but error information can be read from a host computer at start-up
Diagnostic functions	Checks for CPU errors, memory errors, power interruptions, and transmission errors				
Ground	Ground to 100 Ω or less				
Protection rating	For inter-panel installation (IEC 60529 IP30)				
Standards/Approvals	See Appendix B				
Weight	Approx. 890 g	Approx. 930 g	Approx. 960 g		Approx. 360 g

■ Handheld ID Controller

Item	V620-CB-US
	
Power supply	Built-in nickel-cadmium batteries (6 VDC) or 6 AA alkaline batteries (9 VDC)
Power consumption	700 mA max.
Continuous operating time (see note)	3 hrs min. when using the built-in nickel-cadmium batteries; 1.5 hrs min. when using the alkaline batteries
Automatic power-saver	The power is turned off automatically if a key input or response is not received in 10 min
Automatic command cancellation	A command will be cancelled automatically if a response is not received from a Data Carrier within 2 min
Low battery indicator	This display appears when the battery voltage falls below the minimum voltage required for operation
User memory	32K bytes (Data will be retained for at least 24 hrs after batteries are removed)
Vibration resistance	Destruction: 10 to 150 Hz, 0.15-mm single amplitude for 8 min each in X, Y, and Z directions
Shock resistance	Destruction: 200 m/s ² (approx. 20G) 3 times each in X, Y, and Z directions
Ambient temperature	Operating: 0° to 45°C Storage: -20° to +60°C (excluding the battery pack)
Ambient humidity	Operating: 35% to 85%
Operating conditions	No corrosive gases
Protection rating	IEC 60529 IP30
Weight	680 g max. (including the battery pack)

Note: The continuous operating time is for new, fully charged nickel cadmium batteries or new alkaline batteries used at room temperature. An English display and UL-compatible Battery Charger are included with the V620-CB-US-S. The Battery Charger is not included with the V620-CB-US-S1.

■ Monitor Unit

V600-P01 (for use with V620-CA□A Controllers)

The Monitor Unit is a monitoring device that can be mounted to an ID Controller. It can be used to test communications between the R/W Head and Data Carrier when the RFID System is started up, check the data in Data Carriers, and read error information or statistical error information.

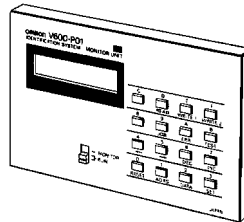

The specifications conform to those of the ID Controller, but the operating temperature range is 0°C to 40°C.

■ V620-CB-US-S Configuration

Model	Name	Remarks
V620-CB-US	Handheld ID Controller	Controller
V600-A11	Battery Case	Accessory (for alkaline batteries)
V600-A12	Battery Pack (Ni-Cd)	Accessory (built-in)
V600-A13	Carrying Belt	Accessory
V600-A14	Battery Charger (120 VAC)	Accessory

■ ID Sensor Units (PLC Modules)

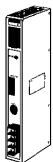
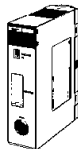
Item	C500-IDS21 (for general use) C500-IDS22 (for long-distance transmission) (See note)	C200H-IDS21
		
Communications control	Dedicated time sharing	
Possible number of R/W Heads	1 R/W Head	
DC memory format	8-bit dedicated format	
Commands	The following 6 commands are used: Read, Write, Auto read, Auto write, Abort, Cancel auto-command processing	
Transmission capacity	Up to 502 bytes (251 words) of data can be batch-transferred using the Intelligent I/O instructions (READ/WRITE)	Up to 1024 bytes (512 words) of data can be transferred (at 20 words/PLC cycle)
Diagnostic functions	1. CPU watchdog timer 2. Detects transmission error with DC, absence of DC 3. Error log function, records transmission errors (with capacitor back-up)	
Monitoring functions	A Handheld Programming Console (with a special keysheet) can be used to monitor operation (max. cable length: 4 m). The following operations are possible: Read 1-byte, Write 1-byte, Continuous write, Test, and Monitor error log	
Memory back-up	The error information has a capacitor back-up. Data retained at least 15 days (at 25°C).	
I/O word allocation	Two words are allocated when the Intelligent I/O instructions (READ/WRITE) are used Four words are allocated when the Intelligent I/O instructions (READ/WRITE) are not used	Five words are allocated within the IR area (IR 100 to IR 199)
External power supply	250 mA min. at 24 VDC	---
Internal current consumption	400 mA max. at 5 VDC	250 mA max. at 5 VDC 120 mA max. at 26 VDC (to drive the R/W Head)
Weight	700 g max.	400 g max.

Note: C500-IDS22 ID Sensor Units must be used with C500-IDA22 ID Adapters. The maximum cable extension length is 200 m.

Transmission Distance Specifications

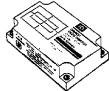
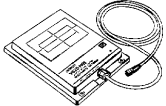
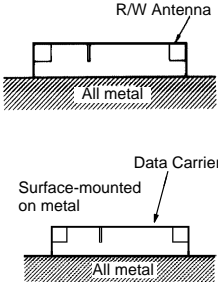
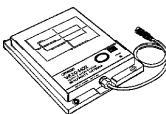
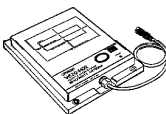
Recommended combinations		Installation		Transmission distance	Data Carrier and R/W Antenna Mounting
Data Carrier	R/W Head				
		Stationary	Surface-mounted on metal	0 to 2 m	
		Moving		0 to 2 m	
		Stationary	Surface-mounted on metal	0 to 0.5 m	
		Moving		0 to 0.5 m	

Transmission Time Specifications

The transmission time does not depend on the model of R/W Head or Data Carrier, although transmission times differ between Data Carriers with and without batteries.

The turn around time (TAT) is the total time required from the issuance of a command from the host device (for example, a host computer) until the reception of a response.

The lower-level communications time does not include the host communications; it is the time required for communications between the R/W Head and Data Carrier. The lower-level communications time is used in the equation for the DC speed.

$$\text{DC Speed} = (\text{Distance travelled in the transmission range}) / (\text{Lower-level communications time})$$

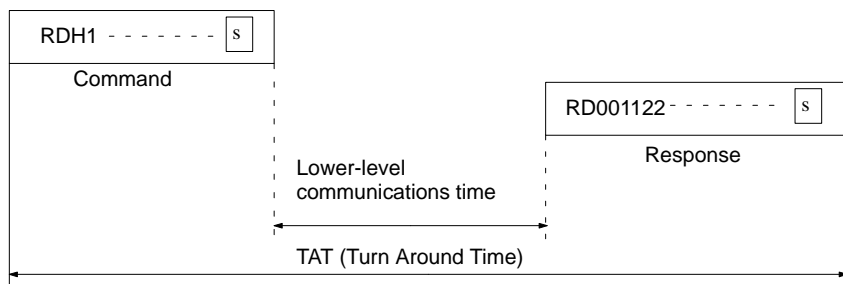

Transmission Time vs. Amount of Data Transferred

The following graph shows the relationship between the transmission time and the number of bytes transferred.

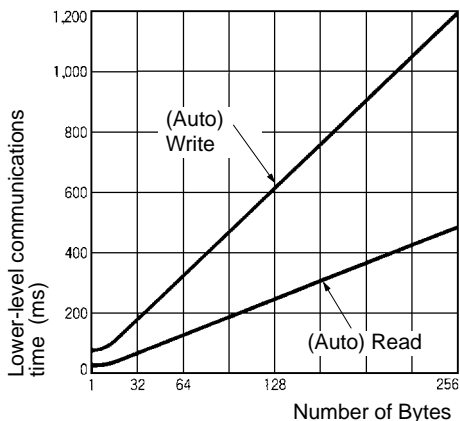

DC Speed vs. Amount of Data Transferred

The following graph shows the relationship between the speed of the DC and the number of bytes transferred for three different distances between the R/W Antenna (V620-H01) and the DC (V620-D8KR01).

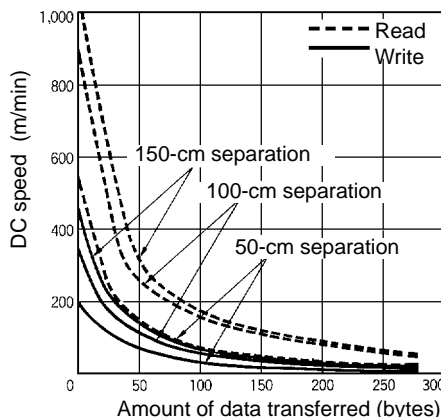

Transmission Range

V620-H01 & V620-D8KR01

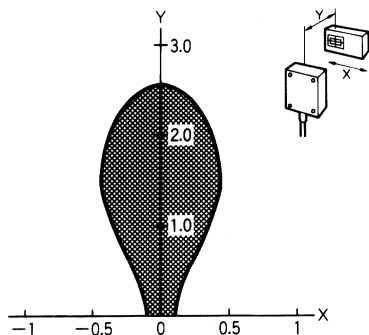

V620-H02 & V620-D8KR01

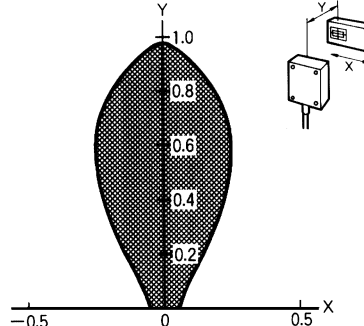

■ R/W range
Unit: m

Data Carrier Battery Life

The following graphs show the relationship between the number of bytes read/written and the battery life.

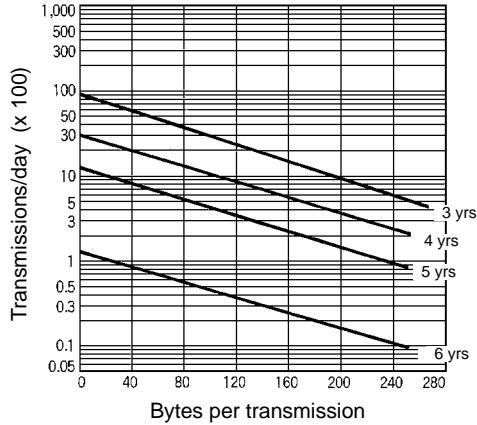

Mutual Interference

■ Mutual Interference between R/W Antennas

When using multiple R/W Antennas be sure to place R/W Antennas at the distances specified below to avoid malfunction caused by mutual interference. Test and adjust the position before using as the interference distance may increase due to ambient metal or reflective surfaces. Mutual interference can be avoided by using materials that absorb electronic waves.

V620-H01

Facing

RD/WT command and auto-command: 10 m min

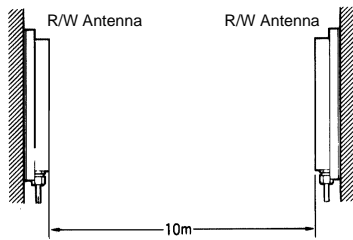

Side-by-side

RD/WT command and auto-command: 5 m min

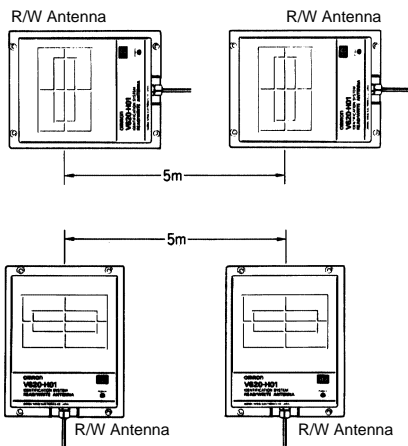

V620-H02

Facing

RD/WT command and auto-command: 4 m min

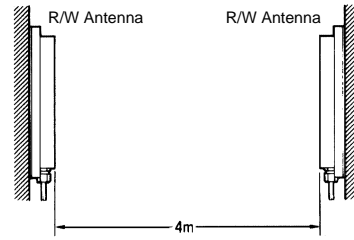

Side-by-side

RD/WT command and auto-command: 1.5 m min

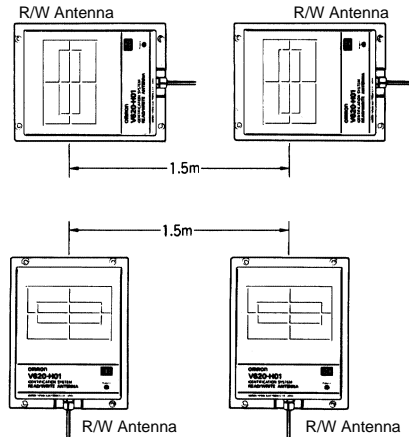

Precautions

Data Carrier Battery

Do not disassemble, deform by applying pressure, heat at temperatures exceeding 100°C, or burn. Doing so may cause the built-in lithium battery to combust or explode.

Dimensions

■ Data Carriers

V620-D8KR01

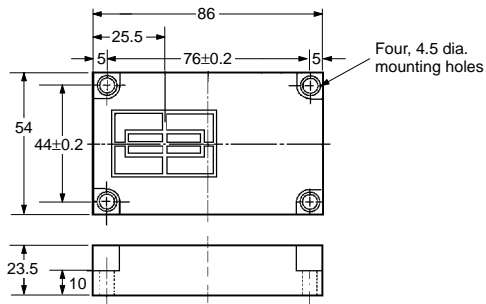

Case: ABS plastic
 Filler: Epoxy plastic

■ R/W Heads

V620-H01/H02

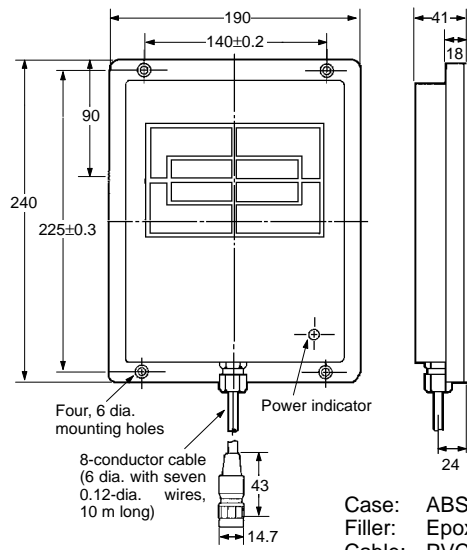

Case: ABS plastic
 Filler: Epoxy plastic
 Cable: PVC (oil-resistant)

■ ID Controllers

V620-CA□A (Multipurpose)

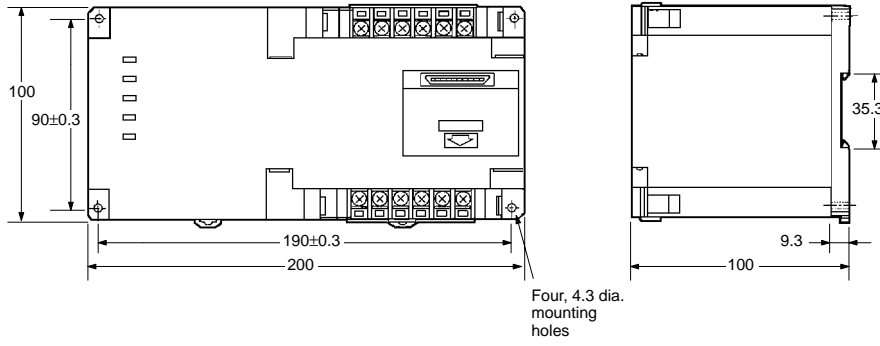

V600-P01 Monitor Unit
(For use with V600-CA□A and V620-CA□A Controllers)

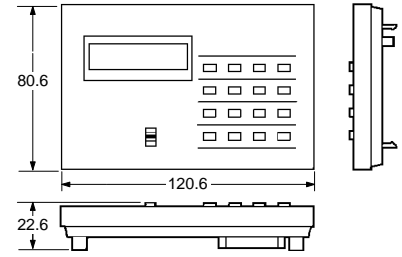

V620-CD1D (Compact)

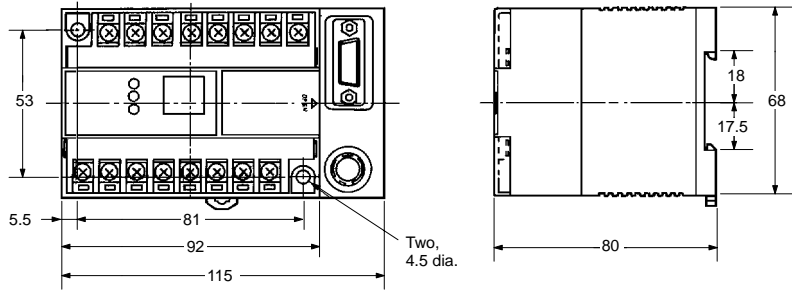

V620-CB-US Handheld ID Controller

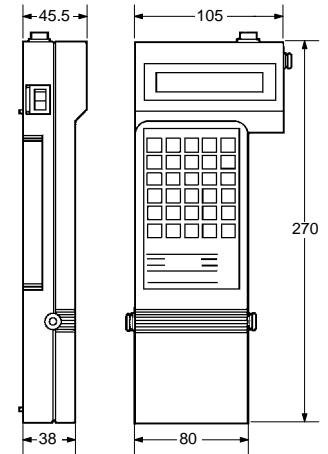

ID Sensor Units/ID Adapters

C500-IDS21/IDS22
C500-IDA22

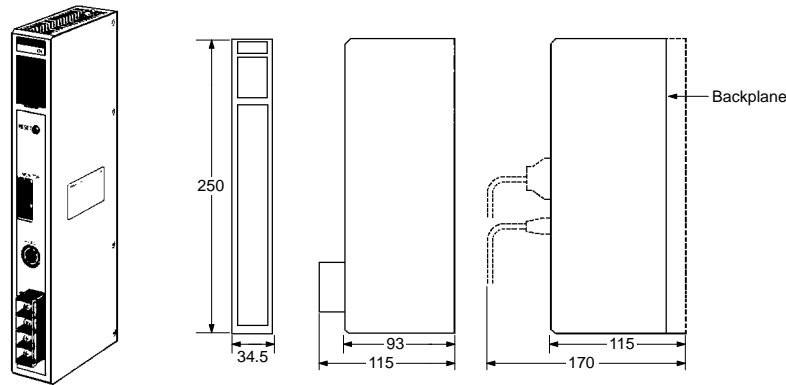

Rack Dimensions (Reference)

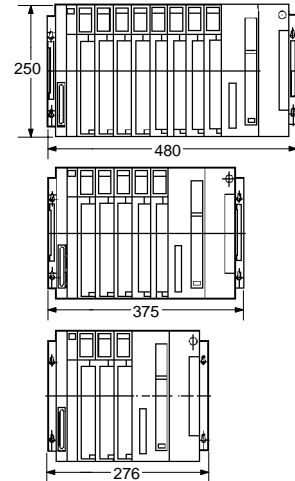

C200H-IDS21

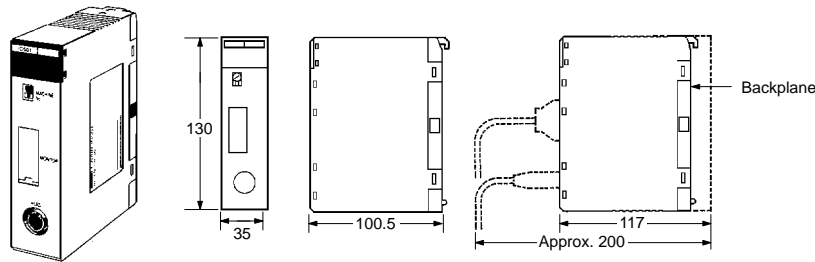

Rack Dimensions (Reference)

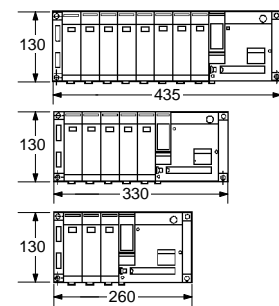



NOTE: DIMENSIONS SHOWN ARE IN MILLIMETERS. To convert millimeters to inches divide by 25.4.

OMRON[®]
OMRON ELECTRONICS, INC.
One East Commerce Drive
Schaumburg, IL 60173
1-800-55-OMRON

OMRON CANADA, INC.
885 Milner Avenue
Scarborough, Ontario M1B 5V8
416-286-6465

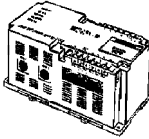
■ ID Controllers

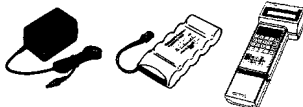
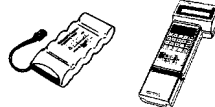
Type	Part number		Specifications/Design	
AC Power Supply	V620-CA1A		100 to 240 VAC, 50/60 Hz Two R/W antenna connectors Dimensions: 200 × 100 × 100 mm	RS-232C host interface
	V620-CA2A			RS-422 host interface
	V620-CA8A			Parallel PNP host interface
	V620-CA9A			Parallel NPN host interface
DC Power Supply	V620-CD1D		24 VDC R/W antenna connectors Dimensions: 165 × 68 × 80 mm	RS-232C host interface
Handheld	V620-CB-US-S (Kit)		A Battery Charger, Ni-Cd Battery Pack, Battery Case, and Carrying Belt are included	
	V620-CB-US-S1 (Kit)		Ni-cd Battery, Battery Case, and Carrying Belt are included	

■ ID Sensor Units/ID Adapters

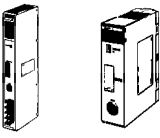
Part number		Specifications		
C500-IDS21	ID Sensor Unit		SYSMAC CV500, CV1000, CVM1, C500(F), C1000H(F), C2000H PLCs	General-purpose
C500-IDS22				Long-distance transmission
C200H-IDS21				General-purpose
C500-IDA22	ID Adapter		Required when using the C500-IDS22 ID Sensor Unit	Long-distance transmission

■ Accessories (Order Separately)

Item	Part number		Specifications/Design	
Extension Cable	V620-A40		Standard cable (Connectors are not water-resistant.)	10 m
	V620-A41			20 m
	V620-A42			30 m

■ RS-232C Cables (Order Separately)

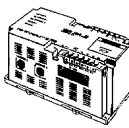
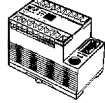
Part number	Cable length	Applicable ID Controller	
XW2Z-200P	2 m	V620-CA1A	
XW2Z-500P	5 m		
XW2Z-200S	2 m	V620-CD1D	
XW2Z-500S	5 m		

■ ID Controller Communications Connectors

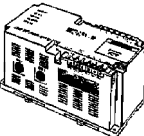
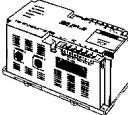
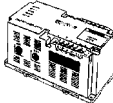
Part number	Name	Applicable ID Controller
XM2A-0901	Connector Plug	V620-CA2A V620-CD1D 
XM2S-0911	Connector Hood	
XM2A-2501	Connector Plug	V620-CA1A 
XM2S-2511	Connector Hood	
MR-50F (Honda Tsushin Kogyo)	Connector Plug	V620-CA8A V620-CA9A 
MR-50L (Honda Tsushin Kogyo)	Connector Hood	

System Configuration

Host System

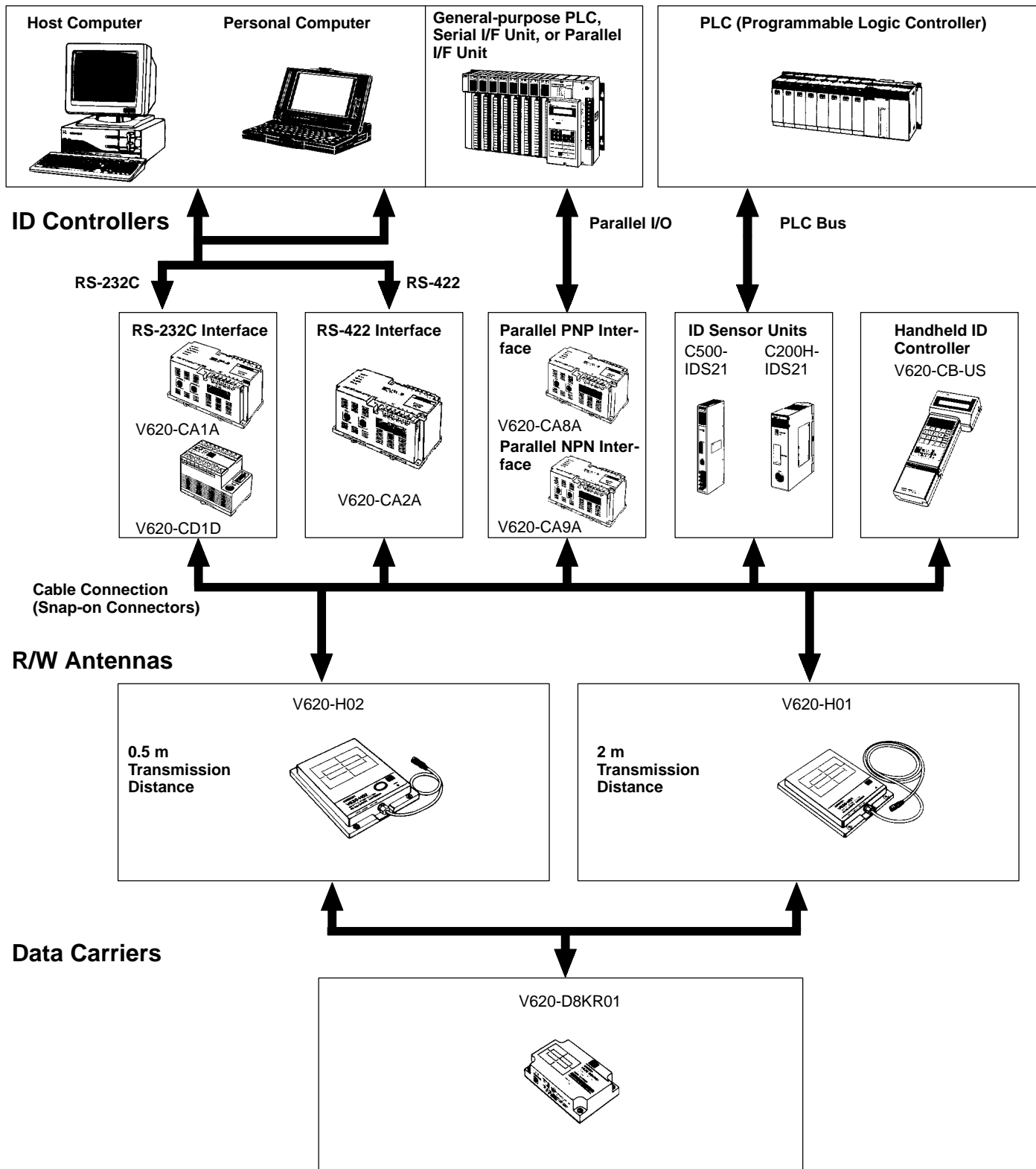

Specifications

■ Data Carriers

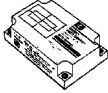
Item	V620-D8KR01 
Memory Capacity	8K byte
Battery life (see note)	Refer to <i>Battery Life vs. Amount of Data Transferred</i> below
Ambient temperature	Operating: -25° to 70°C
Ambient humidity	Operating: 35% to 95%
Protection ratings	IEC 60529 IP67
Vibration resistance	Destruction: 10 to 55 Hz, 1.5-mm double-amplitude for 2 hrs each in X, Y, and Z directions
Shock resistance	Destruction: 500 m/s ² (approx. 50G) for 3 times each in X, Y, and Z directions
Weight	Approx. 120 g

Note: A low battery detection function is built-in.

■ Read/Write (R/W) Antenna

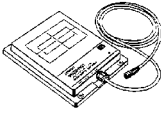
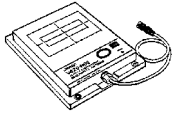
Item	V620-H01 	V620-H02 
Transmission frequency	2,450 MHz	
Antenna's supply power	3 mW max.	1 mW max.
Transmission beam width	±23°C (antenna gain: 12 dB)	±20°C (antenna gain: 13 dB)
Ambient temperature	Operating: -25° to 70°C	
Ambient humidity	Operating: 35% to 95%	
Insulation resistance	50 MΩ (at 500 VDC) between cable terminals and case	
Dielectric strength	500 VAC, 50/60 Hz for 1 min between cable terminals and case	
Protection ratings	IEC 60529 IP66	
Vibration resistance	Destruction: 10 to 55 Hz, 1.5-mm double amplitude for 2 hrs each in X, Y, and Z directions	
Shock resistance	Destruction: 500 m/s ² (approx. 50G) for 3 times each in X, Y, and Z directions (18 times total)	
Cable length (see note 2)	Standard lengths of 0.5 m and 10 m	
Weight	Approx. 2 kg (with 10-m cable, the R/W Antenna itself weighs 1.4 kg max.)	

Note: 1. Connectors are not water-resistant.

2. Various intermediate lengths of cable are available. (Total cable length: 30.5 m max.)

■ ID Controllers

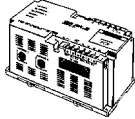
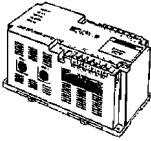
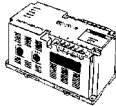
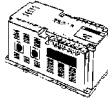
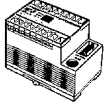
Item	V620-CA1A	V620-CA2A	V620-CA8A	V620-CA9A	V620-CD1D
					
Host interface	RS-232C	RS-422 (Max. of 16 Units can be connected.)	Parallel PNP output	Parallel NPN output	RS-232C
Possible number of R/W Antennas	2				1
Power supply voltage	100 to 240 VAC, 50/60 Hz				24 VDC
Acceptable power supply voltage	85 to 264 VAC				20.4 to 26.4 VDC
Power consumption	35 VA max.				7.2 W max.
Insulation resistance	50 MΩ min. (at 500 VDC) between power terminals and case, between I/O terminals and case, or between the power supply terminals and I/O terminals				
Dielectric strength	1,500 VAC, 50/60 Hz for 1 min between the points listed above; Leakage current: 10 mA max.				1,000 VAC, 50/60 Hz for 1 min between the points listed above. Leakage current: 10 mA max.
Noise immunity	1,500 V (p-p) pulses of 100 ns to 1 μs pulse width with a 1 ns rise time				
Vibration resistance	Destruction: 10 to 150 Hz, 0.3-mm double amplitude for 32 min each in X, Y, and Z directions Malfunction: 10 to 150 Hz, 0.2-mm double amplitude for 32 min each in X, Y, and Z directions				
Shock resistance	Destruction: 200 m/s ² (approx. 20G) for 3 times each in X, Y, and Z directions				
Ambient temperature	Operating: -10° to 55°C Storage: -25° to 65°C				
Ambient humidity	Operating: 35% to 85% (with no condensation)				
Operating conditions	No corrosive gases				
Memory back-up	A capacitor backs up the most recent error data and statistical error data for up to 20 days (at 25°C) after a power interruption				Memory is not backed up, but error information can be read from a host computer at start-up
Diagnostic functions	Checks for CPU errors, memory errors, power interruptions, and transmission errors				
Ground	Ground to 100 Ω or less				
Protection rating	For inter-panel installation (IEC 60529 IP30)				
Standards/Approvals	See Appendix B				
Weight	Approx. 890 g	Approx. 930 g	Approx. 960 g		Approx. 360 g

■ Handheld ID Controller

Item	V620-CB-US
	
Power supply	Built-in nickel-cadmium batteries (6 VDC) or 6 AA alkaline batteries (9 VDC)
Power consumption	700 mA max.
Continuous operating time (see note)	3 hrs min. when using the built-in nickel-cadmium batteries; 1.5 hrs min. when using the alkaline batteries
Automatic power-saver	The power is turned off automatically if a key input or response is not received in 10 min
Automatic command cancellation	A command will be cancelled automatically if a response is not received from a Data Carrier within 2 min
Low battery indicator	This display appears when the battery voltage falls below the minimum voltage required for operation
User memory	32K bytes (Data will be retained for at least 24 hrs after batteries are removed)
Vibration resistance	Destruction: 10 to 150 Hz, 0.15-mm single amplitude for 8 min each in X, Y, and Z directions
Shock resistance	Destruction: 200 m/s ² (approx. 20G) 3 times each in X, Y, and Z directions
Ambient temperature	Operating: 0° to 45°C Storage: -20° to +60°C (excluding the battery pack)
Ambient humidity	Operating: 35% to 85%
Operating conditions	No corrosive gases
Protection rating	IEC 60529 IP30
Weight	680 g max. (including the battery pack)

Note: The continuous operating time is for new, fully charged nickel cadmium batteries or new alkaline batteries used at room temperature. An English display and UL-compatible Battery Charger are included with the V620-CB-US-S. The Battery Charger is not included with the V620-CB-US-S1.

■ Monitor Unit

V600-P01 (for use with V620-CA□A Controllers)

The Monitor Unit is a monitoring device that can be mounted to an ID Controller. It can be used to test communications between the R/W Head and Data Carrier when the RFID System is started up, check the data in Data Carriers, and read error information or statistical error information.

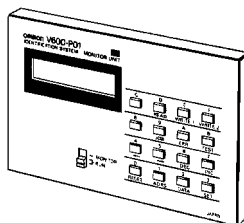



The specifications conform to those of the ID Controller, but the operating temperature range is 0°C to 40°C.

■ V620-CB-US-S Configuration

Model	Name	Remarks
V620-CB-US	Handheld ID Controller	Controller
V600-A11	Battery Case	Accessory (for alkaline batteries)
V600-A12	Battery Pack (Ni-Cd)	Accessory (built-in)
V600-A13	Carrying Belt	Accessory
V600-A14	Battery Charger (120 VAC)	Accessory

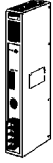
■ ID Sensor Units (PLC Modules)

Item	C500-IDS21 (for general use) C500-IDS22 (for long-distance transmission) (See note)	C200H-IDS21
		
Communications control	Dedicated time sharing	
Possible number of R/W Heads	1 R/W Head	
DC memory format	8-bit dedicated format	
Commands	The following 6 commands are used: Read, Write, Auto read, Auto write, Abort, Cancel auto-command processing	
Transmission capacity	Up to 502 bytes (251 words) of data can be batch-transferred using the Intelligent I/O instructions (READ/WRITE)	Up to 1024 bytes (512 words) of data can be transferred (at 20 words/PLC cycle)
Diagnostic functions	1. CPU watchdog timer 2. Detects transmission error with DC, absence of DC 3. Error log function, records transmission errors (with capacitor back-up)	
Monitoring functions	A Handheld Programming Console (with a special keysheet) can be used to monitor operation (max. cable length: 4 m). The following operations are possible: Read 1-byte, Write 1-byte, Continuous write, Test, and Monitor error log	
Memory back-up	The error information has a capacitor back-up. Data retained at least 15 days (at 25°C).	
I/O word allocation	Two words are allocated when the Intelligent I/O instructions (READ/WRITE) are used Four words are allocated when the Intelligent I/O instructions (READ/WRITE) are not used	Five words are allocated within the IR area (IR 100 to IR 199)
External power supply	250 mA min. at 24 VDC	---
Internal current consumption	400 mA max. at 5 VDC	250 mA max. at 5 VDC 120 mA max. at 26 VDC (to drive the R/W Head)
Weight	700 g max.	400 g max.

Note: C500-IDS22 ID Sensor Units must be used with C500-IDA22 ID Adapters. The maximum cable extension length is 200 m.

Transmission Distance Specifications

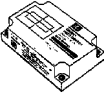
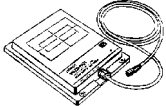
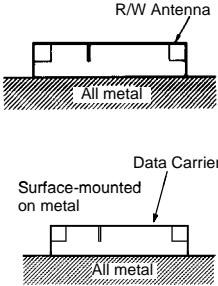
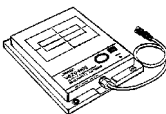
Recommended combinations		Installation		Transmission distance	Data Carrier and R/W Antenna Mounting
Data Carrier	R/W Head				
		Stationary	Surface-mounted on metal	0 to 2 m	
		Moving		0 to 2 m	
		Stationary	Surface-mounted on metal	0 to 0.5 m	
		Moving		0 to 0.5 m	

Transmission Time Specifications

The transmission time does not depend on the model of R/W Head or Data Carrier, although transmission times differ between Data Carriers with and without batteries.

The turn around time (TAT) is the total time required from the issuance of a command from the host device (for example, a host computer) until the reception of a response.

The lower-level communications time does not include the host communications; it is the time required for communications between the R/W Head and Data Carrier. The lower-level communications time is used in the equation for the DC speed.

$$\text{DC Speed} = (\text{Distance travelled in the transmission range}) / (\text{Lower-level communications time})$$

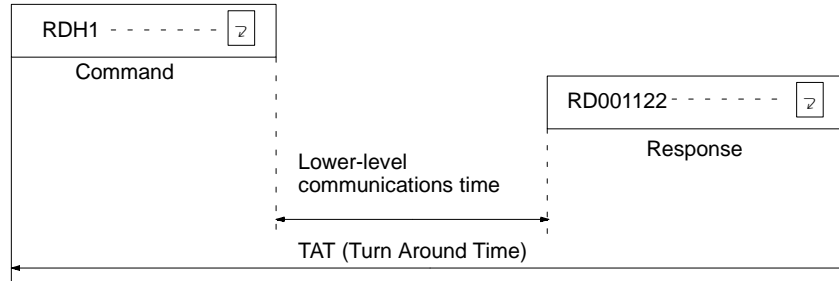

Transmission Time vs. Amount of Data Transferred

The following graph shows the relationship between the transmission time and the number of bytes transferred.

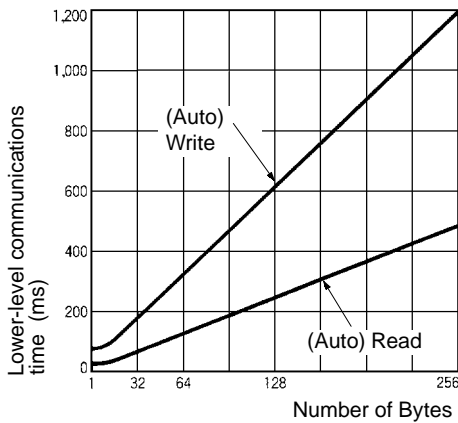

DC Speed vs. Amount of Data Transferred

The following graph shows the relationship between the speed of the DC and the number of bytes transferred for three different distances between the R/W Antenna (V620-H01) and the DC (V620-D8KR01).

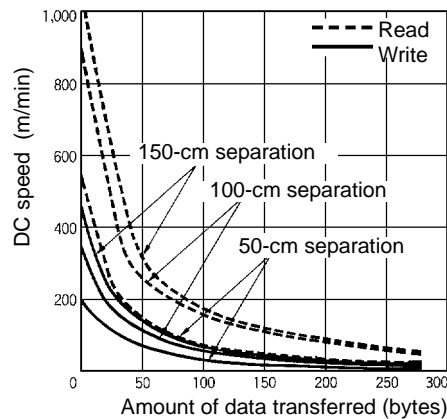

Transmission Range

V620-H01 & V620-D8KR01

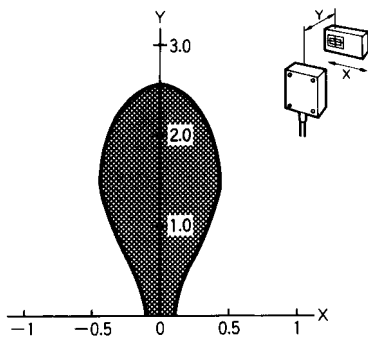

V620-H02 & V620-D8KR01

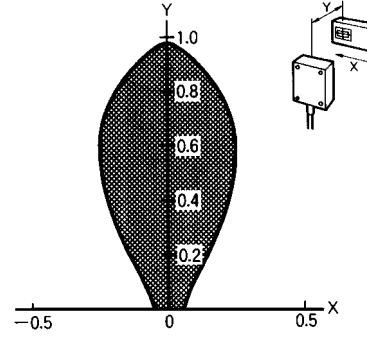

■ R/W range
Unit: m

Data Carrier Battery Life

The following graphs show the relationship between the number of bytes read/written and the battery life.

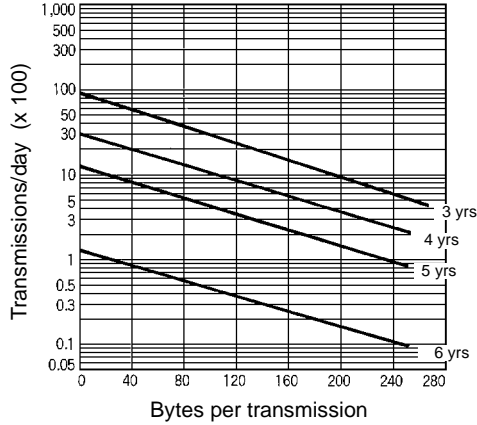

Mutual Interference

■ Mutual Interference between R/W Antennas

When using multiple R/W Antennas be sure to place R/W Antennas at the distances specified below to avoid malfunction caused by mutual interference. Test and adjust the position before using as the interference distance may increase due to ambient metal or reflective surfaces. Mutual interference can be avoided by using materials that absorb electronic waves.

V620-H01

Facing

RD/WT command and auto-command: 10 m min

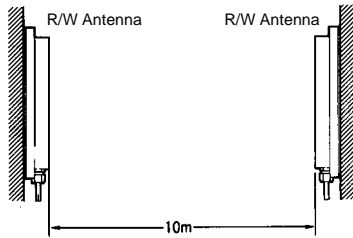

Side-by-side

RD/WT command and auto-command: 5 m min

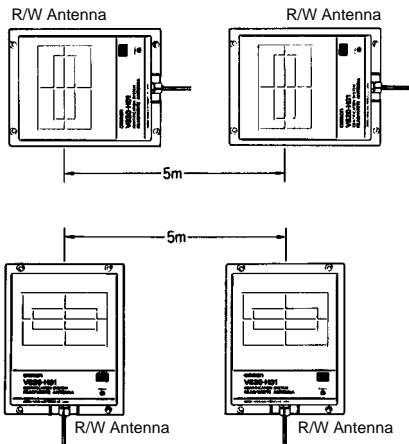

V620-H02

Facing

RD/WT command and auto-command: 4 m min

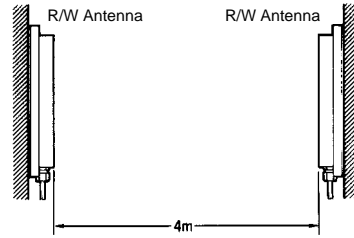

Side-by-side

RD/WT command and auto-command: 1.5 m min

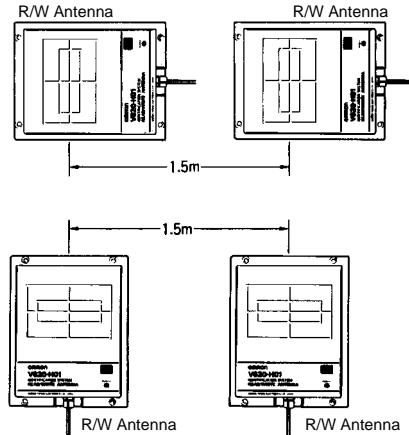

Precautions

Data Carrier Battery

Do not disassemble, deform by applying pressure, heat at temperatures exceeding 100°C, or burn. Doing so may cause the built-in lithium battery to combust or explode.

Dimensions

■ Data Carriers

V620-D8KR01

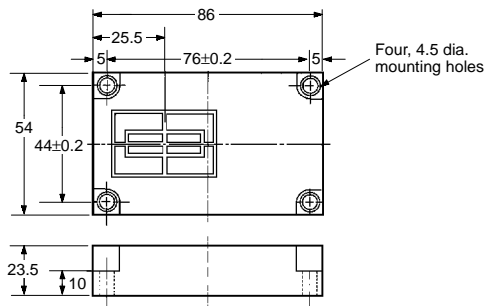

Case: ABS plastic
 Filler: Epoxy plastic

■ R/W Heads

V620-H01/H02

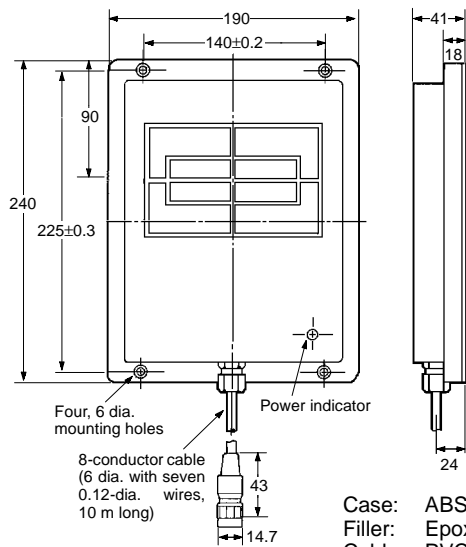

Case: ABS plastic
 Filler: Epoxy plastic
 Cable: PVC (oil-resistant)

■ ID Controllers

V620-CA□A (Multipurpose)

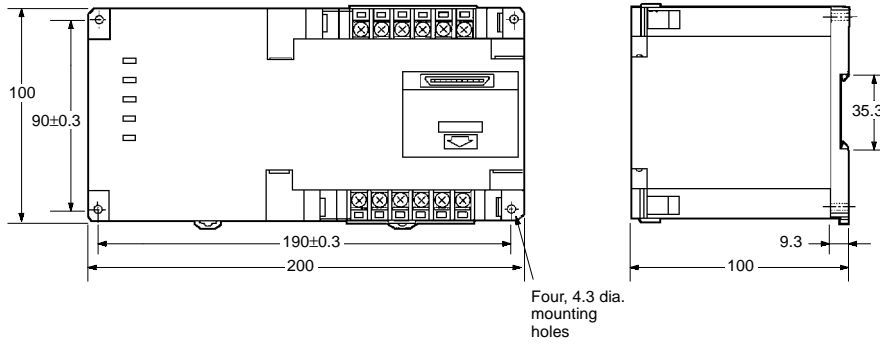

V600-P01 Monitor Unit
(For use with V600-CA□A and V620-CA□A Controllers)

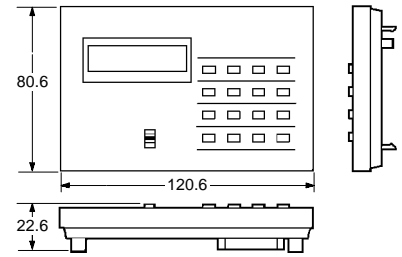

V620-CD1D (Compact)

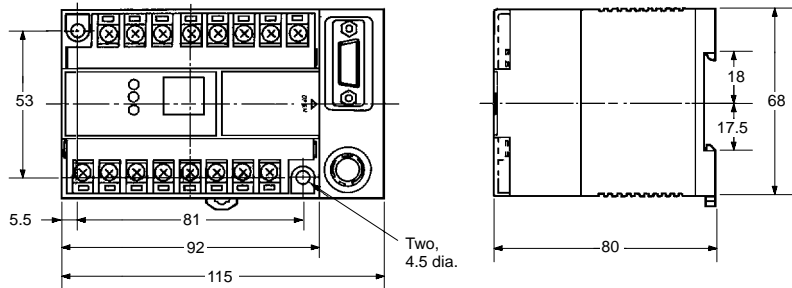

V620-CB-US Handheld ID Controller

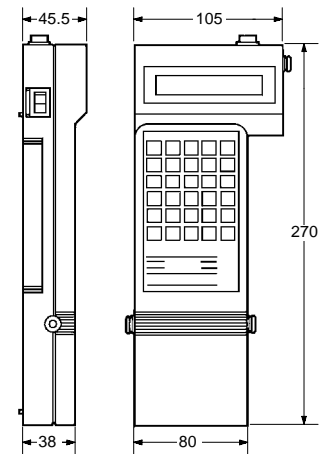

ID Sensor Units/ID Adapters

C500-IDS21/IDS22
C500-IDA22

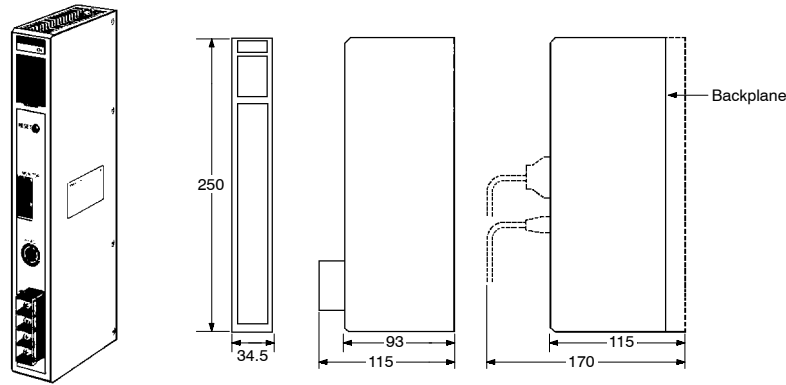

Rack Dimensions (Reference)

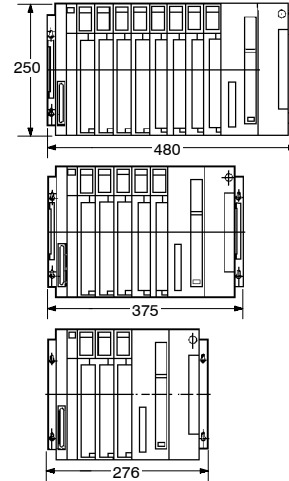

C200H-IDS21

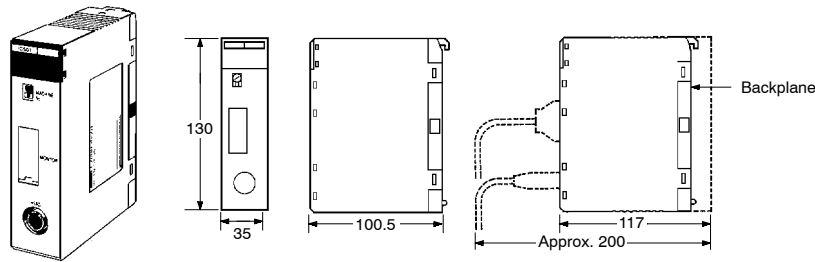

Rack Dimensions (Reference)

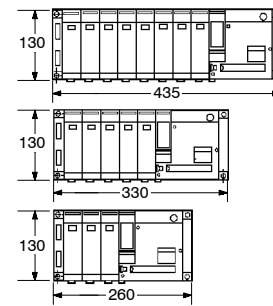

NOTE: DIMENSIONS SHOWN ARE IN MILLIMETERS. To convert millimeters to inches divide by 25.4.

OMRON[®]
OMRON ELECTRONICS, INC.
One East Commerce Drive
Schaumburg, IL 60173
1-800-55-OMRON

OMRON CANADA, INC.
885 Milner Avenue
Scarborough, Ontario M1B 5V8
416-286-6465

X-ON Electronics

Largest Supplier of Electrical and Electronic Components

Click to view similar products for [D-Sub Cables](#) category:

Click to view products by [Omron](#) manufacturer:

Other Similar products are found below :

[1200980218](#) [1200980067](#) [RB09P09P-006](#) [RB09P09P-012](#) [RB15P15P-006](#) [RB25P25P-006](#) [RB37P37P-024](#) [172-0906](#) [SHD15P15S-012](#)
[SHD15P15S-036](#) [SHD15P15S-060](#) [ACL-10137-2MM](#) [RB09P09P-024](#) [319285-3](#) [RS422-OM2](#) [SHD26P26S-060](#) [SHD44P44S-036](#) [73-](#)
[6210MM-6](#) [C200H-CN320-EU](#) [49725A 060S2](#) [73231-1321](#) [SDB-50AFFM-SL7A02](#) [49760A 060S2](#) [HDB-26AFFM-SL7A02](#) [30-9503P](#) [30-](#)
[9522P](#) [73-6220MM-6](#) [1200980058](#) [1200980066](#) [1200980078](#) [1200980052](#) [1200980093](#) [1200980028](#) [1200980021](#) [1200980127](#) [SDB-](#)
[09AFFM-SL7A02](#) [SDB-15AMMM-SL7A01](#) [BB-LDVYCBL](#) [83421-9286](#) [MLDM2L-21P-6K7-18B](#) [KSFD1](#) [MM-2J2-021-SS1-41WN](#) [HDB-](#)
[78AMMM-SL7A05](#) [SDB-37AMMM-SL7A03](#) [SDB-15AFFM-SL7A05](#) [ACC-500-163-R](#) [172-1910](#) [2900907/21.4](#) [VS-25-DSUB-20-LI-2,0](#)
[VS-25-DSUB-20-LI-5,0](#)