

XR2/XR3 IC Sockets

Highly Reliable Sockets That Withstand Instantaneous Signal Failures - Ideal for High-speed Data Processing Circuits

- Incorporate round pins with four-point contacts, ensuring high reliability with excellent vibration and shock-resistance characteristics.
- Highly effective in suppressing flux rising.

Connection Examples

● 2-Row Models

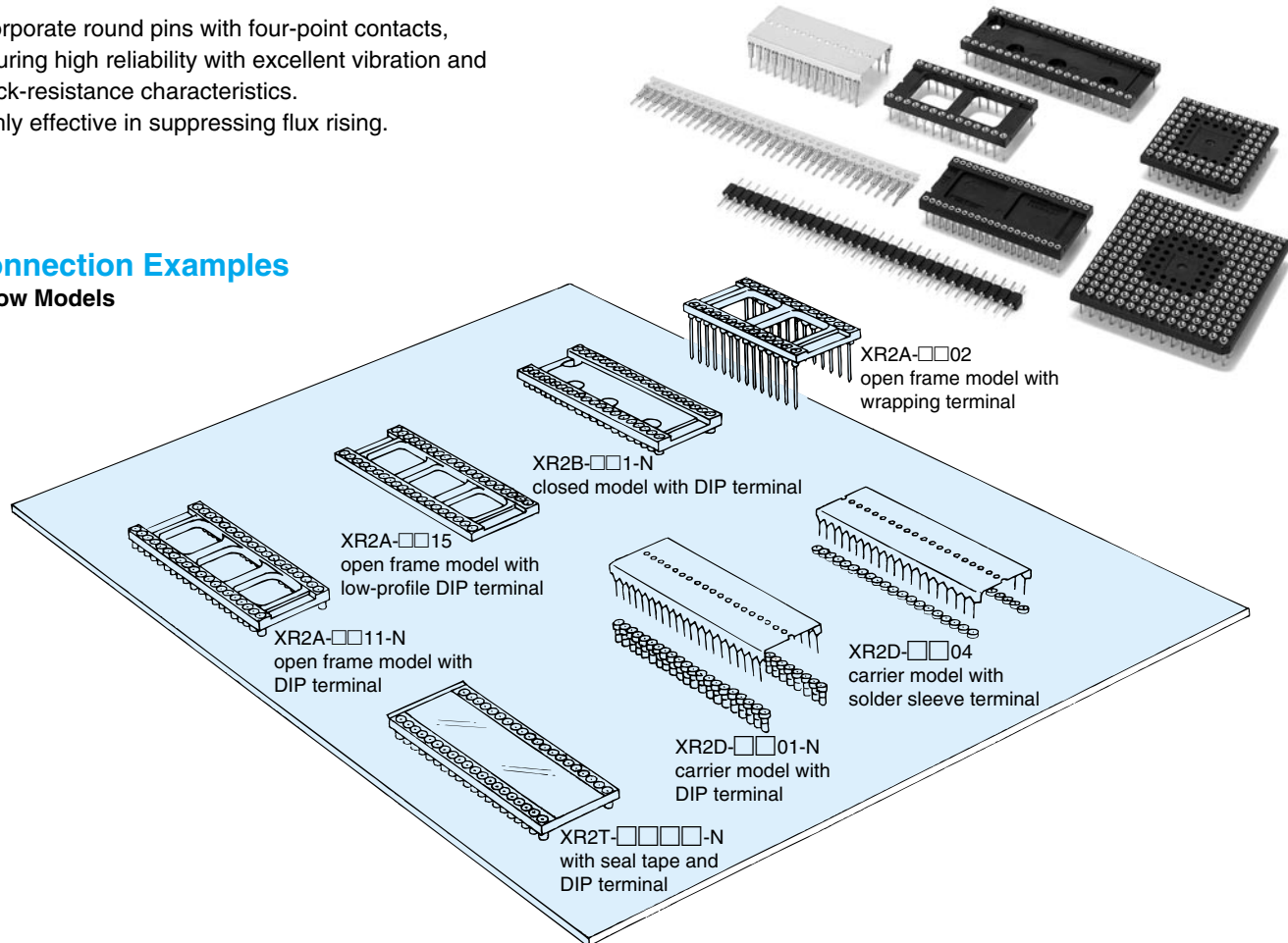

● 1-Row and Shrink Models

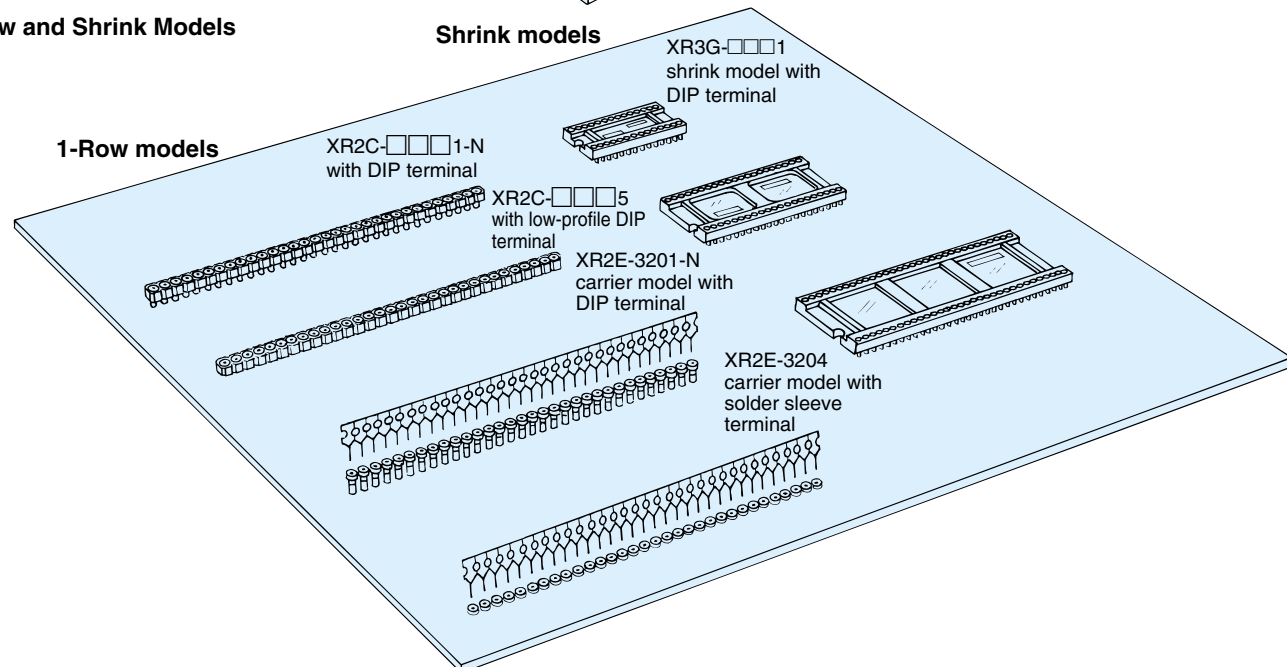

● PGA Sockets

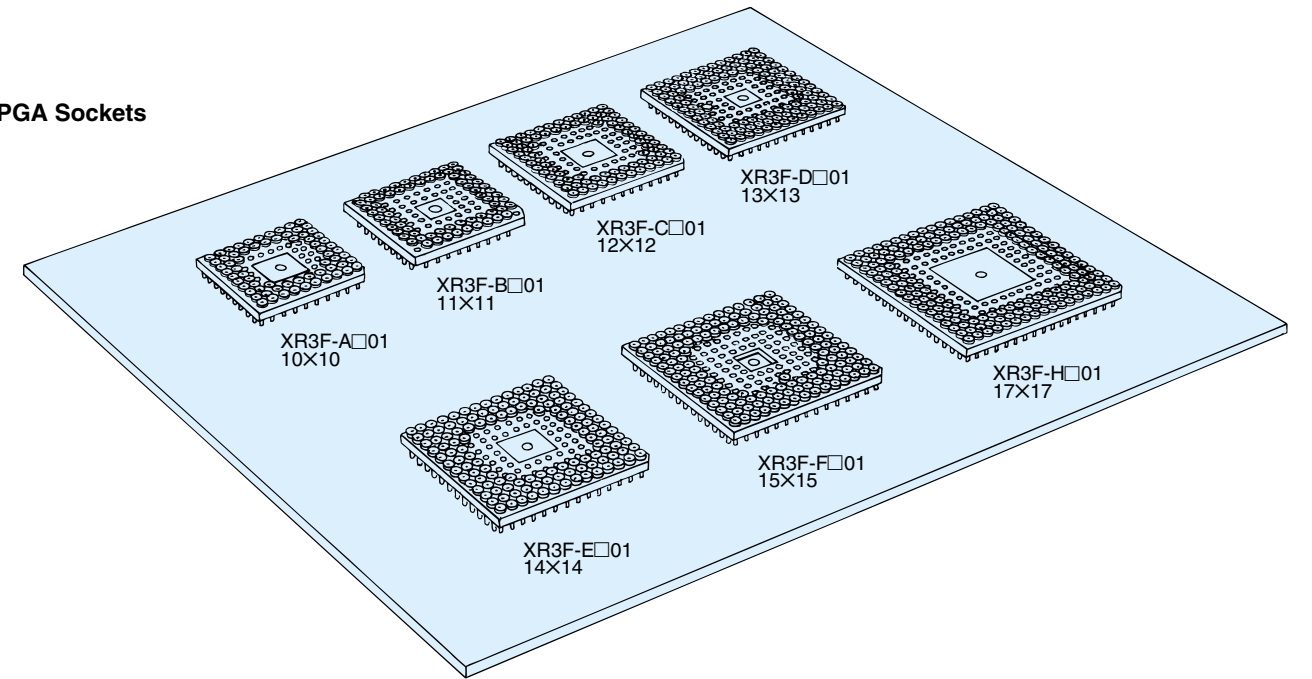

● (ZIP) Zigzag Sockets, Round-pin Plugs, and IC Clamps

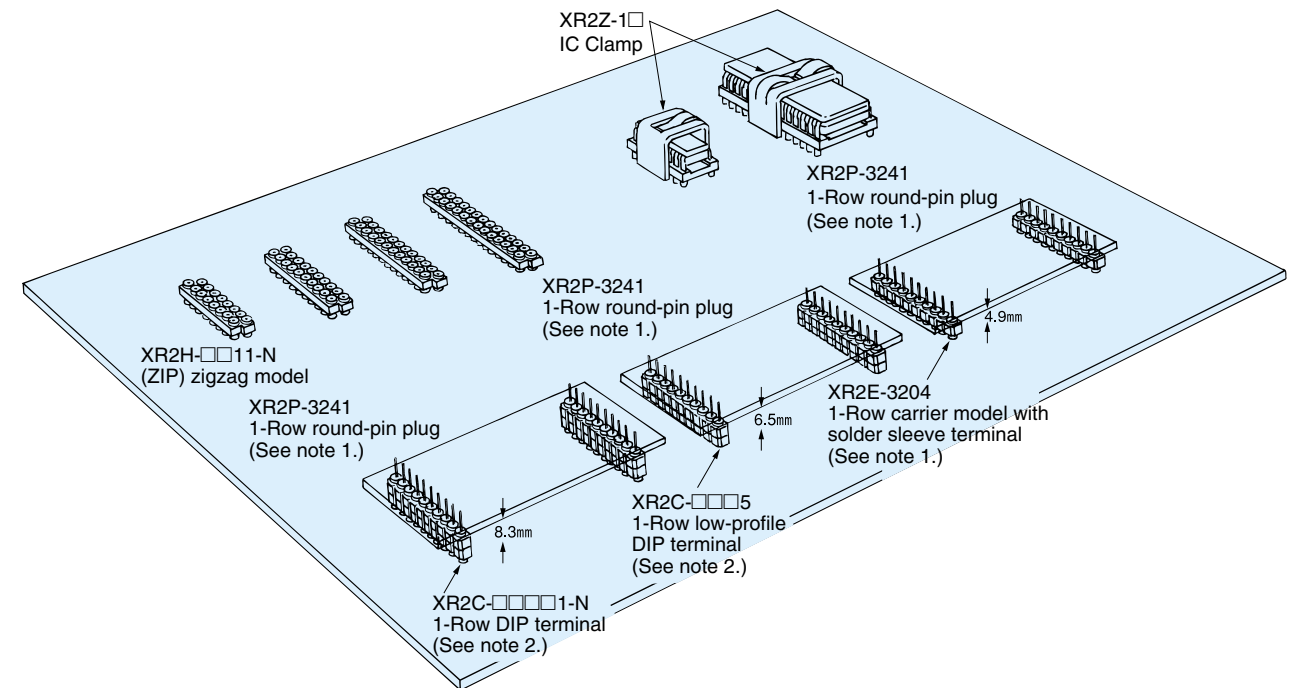

Note 1: A standard model has 32 poles. Cut the plug to the appropriate number of poles.
 Note 2: A standard model has 32 or 20 poles. Cut the plug to the appropriate number of poles.

XR2/XR3 IC Sockets

*1: Au 0.25 μ m *2: Au 0.75 μ m *3: Su plating

Ordering Information

XR2A Open frame models

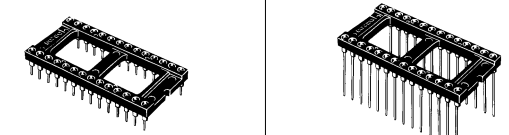
Shape	DIP terminal XR2A-□□11-N *1 XR2A-2463-N *1, 24** XR2A-2473-N *1, 24*** XR2A-□□01-N *2 XR2A-2461-N *2, 24** XR2A-2471-N *2, 24*** XR2A-□□21-N *3 XR2A-2467-N *3, 24** XR2A-2477-N *3, 24***	Wrapping terminal XR2A-□□02
		
Number of contacts	8,14,16,18,20,22,24,28,32,40,42,48,50,64	

XR2A Open frame models (Low-profile DIP terminal)

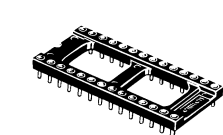
Shape	Low-profile DIP terminal XR2A-□□15 *1 XR2A-2466 *1, 24** XR2A-2476 *1, 24*** XR2A-□□05 *2 XR2A-2465 *2, 24** XR2A-2475 *2, 24*** XR2A-□□25 *3 XR2A-2468 *3, 24** XR2A-2478 *3, 24***
	
Number of contacts	8,14,16,18,20,22,24,28,32,40,42,48,64

XR2C 1-Row Connectors

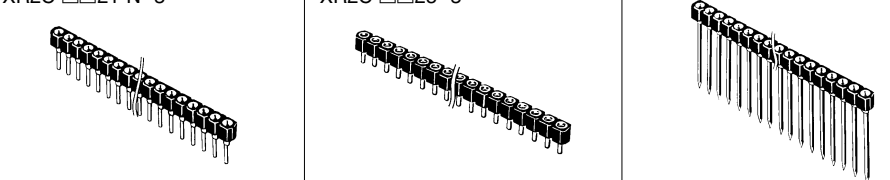
Shape	DIP terminal XR2C-□□11-N *1 XR2C-□□01-N *2 XR2C-□□21-N *3	Low-profile DIP terminal XR2C-□□15 *1 XR2C-□□05 *2 XR2C-□□25 *3	Wrapping terminal XR2C-□□02 *2
			
Number of contacts	10,16,20,32	20,32	20,32

XR2B Closed models

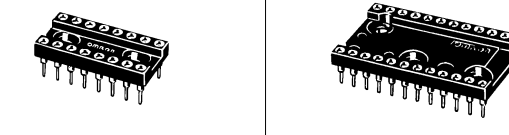
Shape	DIP terminal XR2B-1611-N *1 XR2B-1601-N *2	DIP terminal XR2B-□□11-N *1 XR2B-□□01-N *2
		
Number of contacts	16,24,28,32,40	

XR2T Open frame models with sealing tape

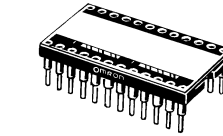
Shape	DIP terminal XR2T-□□11-N *1 XR2T-2463-N *1, 24** XR2T-2473-N *1, 24*** XR2T-□□01-N *2 XR2T-2461-N *2, 24** XR2T-2471-N *2, 24*** XR2T-□□21-N *3 XR2T-2467-N *3, 24** XR2T-2477-N *3, 24***
	
Number of contacts	8,14,16,18,20,22,24,28,32,40,48

XR2D 2-Row carrier models

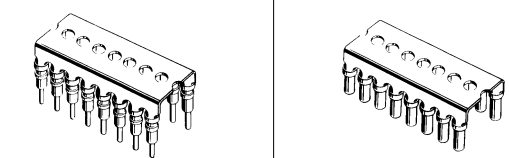
Shape	DIP terminal XR2D-□□01-N *2	Solder sleeve terminal XR2D-□□04 *2
		
Number of contacts	8,14,16,18,20,24,28,32,40	

XR2E 1-Row carrier models

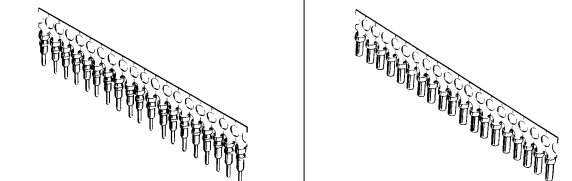
Shape	DIP terminal XR2E-3201-N *2	Solder sleeve terminal XR2E-3204 *2
		
Number of contacts	32	

XR2H ZIP (Zigzag) connectors

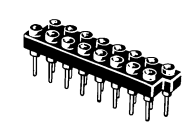
Shape	DIP terminal XR2H-□□11-N *1
	
Number of contacts	16,20,24,28

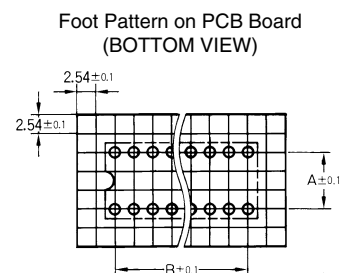

Number of contacts	Pitch (mm)	A	B
8	7.62	7.62	7.62
14	7.62	15.24	15.24
16	7.62	17.78	17.78
18	7.62	20.32	20.32
20	7.62	22.86	22.86
22	10.16	25.40	25.40
24	15.24	27.94	27.94
24**	10.16	27.94	27.94
24***	7.62	27.94	27.94
28	15.24	33.02	33.02
32	15.24	38.10	38.10
40	15.24	48.26	48.26
42	15.24	50.80	50.80
48	15.24	58.42	58.42
50	22.86	60.96	60.96
64	22.86	78.74	78.74

** : XR2□-246□
*** : XR2□-247□

XR2P 1-Row round-pin plugs

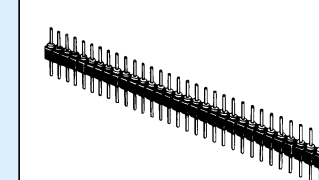
Shape	Straight terminal XR2P-□□41
	
Number of contacts	10,16,20,32

Accessory

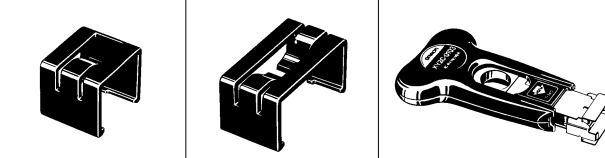
Shape	IC Clamps XR2Z-11	IC Clamps XR2Z-13	IC Puller XY2C-0101 *1 XY2C-0103 *2
			
*1: Number of contacts	14,16,18,20,24	24,28,32,40,42,48	14,16,18,20
*2: Number of contacts			24,28,32,40

XR2/XR3 IC Sockets

Ordering Information

XR3F PGA sockets (10x10)

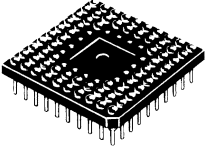
Shape	DIP terminal XR3F-A101 *1 XR3F-A201 *2 XR3F-A301 *3	
Number of contacts	64 (*1), 68 (*2), 84 (*3)	

XR3F PGA sockets (11x11)

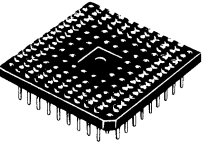
Shape	DIP terminal XR3F-B101 *1 XR3F-B201 *2 XR3F-B301 *3 XR3F-B401 *4 XR3F-B501 *5 XR3F-B601 *6 XR3F-B701 *7 XR3F-B801 *8	
Number of contacts	65 (*1), 68 (*2), 72 (*3 *4), 73 (*5), 84 (*6), 85 (*7), 96 (*8)	

XR3F PGA sockets (12x12)

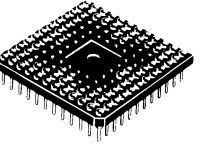
Shape	DIP terminal XR3F-C101 *1 XR3F-C201 *2 XR3F-C301 *3	
Number of contacts	84 (*1), 88 (*2), 89 (*3)	

XR3F PGA sockets (13x13)

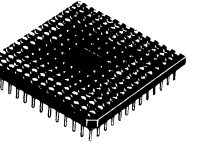
Shape	DIP terminal XR3F-D101 *1 XR3F-D201 *2 XR3F-D301 *3 XR3F-D401 *4 XR3F-D501 *5 XR3F-D601 *6 XR3F-D701 *7	
Number of contacts	88 (*1), 114 (*2), 120 (*3), 121 (*4), 124 (*5), 128 (*6), 132 (*7)	

XR3F PGA sockets (14x14)

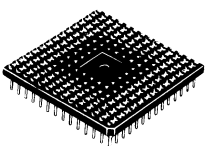
Shape	DIP terminal XR3F-E101 *1 XR3F-E201 *2 XR3F-E301 *3	
Number of contacts	132 (*1), 133 (*2), 135 (*3)	

XR3F PGA sockets (15x15)

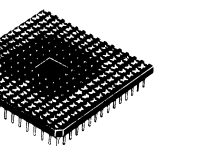
Shape	DIP terminal XR3F-F101 *1 XR3F-F201 *2 XR3F-F301 *3 XR3F-F401 *4 XR3F-F501 *5	
Number of contacts	149 (*1), 176 (*2), 177 (*3), 179 (*4), 180 (*5)	

XR3F PGA sockets (17x17)

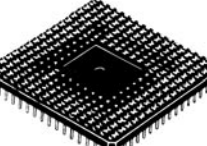
Shape	DIP terminal XR3F-H101 *1 XR3F-H201 *2	
Number of contacts	168 (*1), 169 (*2)	

PGA (BOTTOM VIEW)

10x10

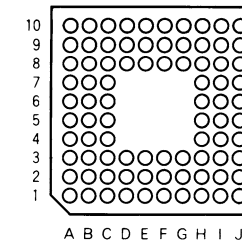

13x13

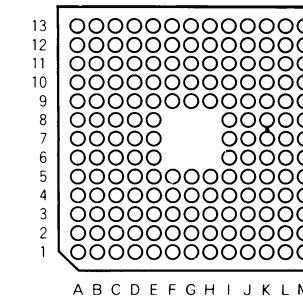

17x17

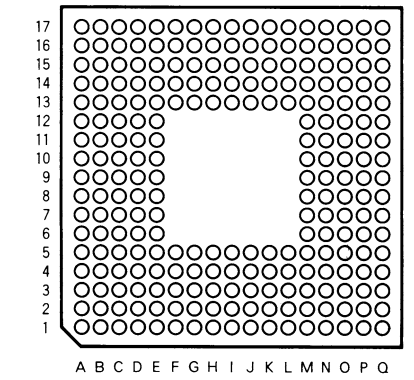

11x11

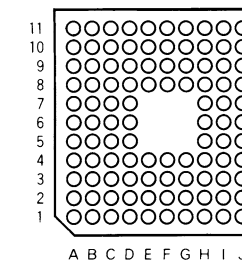

14x14

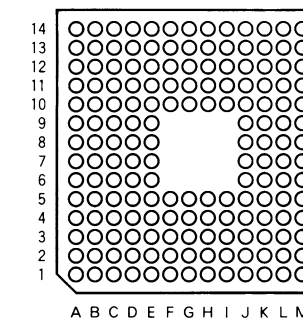

12x12

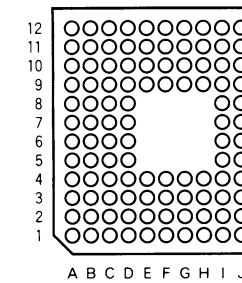

15x15

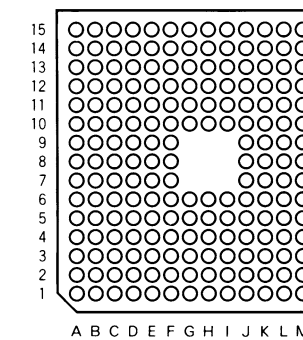

X-ON Electronics

Largest Supplier of Electrical and Electronic Components

Click to view similar products for [Extraction, Removal & Insertion Tools](#) category:

Click to view products by [Omron](#) manufacturer:

Other Similar products are found below :

[M8196914-08](#) [768211-2](#) [809-131](#) [844751-2](#) [8-59558-2](#) [91018-1](#) [12014013](#) [12093647](#) [1-21048-0](#) [R282867020](#) [12093078](#) [12180559](#) [1-21048-6](#) [12121897](#) [DCF.91.405.5LT](#) [1322](#) [15314260](#) [15350698](#) [15350707](#) [15430130](#) [1579018-4](#) [1643916-1](#) [1-679532-0](#) [1976593-3](#)
[OUTEXT-0321](#) [2-1579008-3](#) [2-1579008-4](#) [229694-7](#) [231106-1](#) [241469](#) [91040-3](#) [91040-7](#) [965004-000](#) [965069-000](#) [1738219-1](#) [ET-JL05-16](#)
[FG 0300 146 3000](#) [FIT-6](#) [210S048](#) [2-1579007-9](#) [231879-1](#) [312138-3](#) [RJ11FODE](#) [356-162](#) [M8196914-10](#) [4-1579018-0](#) [483249-1](#) [5-1579007-2](#) [5-1579007-9](#) [BPR10](#)