



ON Semiconductor®

<http://onsemi.com>

# 2SD1207

## Bipolar Transistor 50V, 2A, Low VCE(sat) NPN Single MP

### Applications

- Power supplies, relay drivers, lamp drivers, and automotive wiring

### Features

- FBET and MBIT processed
- Low saturation voltage
- Large current capacity and wide SOA

### Specifications

**Absolute Maximum Ratings** at  $T_a = 25^\circ\text{C}$

Parameter	Symbol	Conditions	Ratings	Unit
Collector to Base Voltage	$V_{CB0}$		60	V
Collector to Emitter Voltage	$V_{CEO}$		50	V
Emitter to Base Voltage	$V_{EBO}$		6	V
Collector Current	$I_C$		2	A
Collector Current (Pulse)	$I_{CP}$		4	A
Collector Dissipation	PC		1	W
Junction Temperature	$T_j$		150	$^\circ\text{C}$
Storage Temperature	$T_{stg}$		-55 to +150	$^\circ\text{C}$

Stresses exceeding Maximum Ratings may damage the device. Maximum Ratings are stress ratings only. Functional operation above the Recommended Operating Conditions is not implied. Extended exposure to stresses above the Recommended Operating Conditions may affect device reliability.

### Package Dimensions

unit : mm (typ)

7520-002

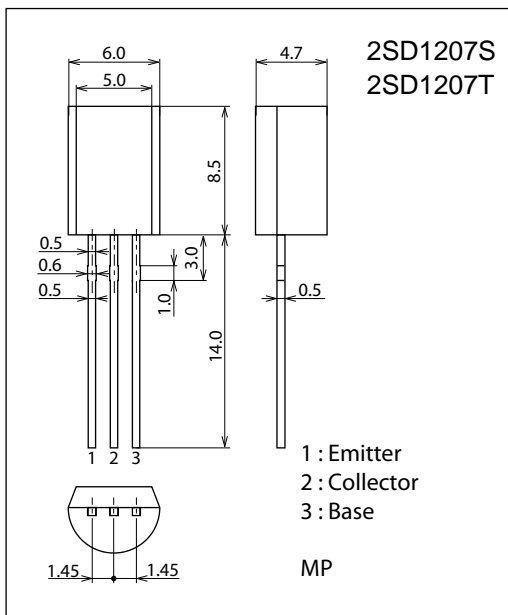

### Product & Package Information

- Package : MP
- JEITA, JEDEC : SC-51, TO-92(1-WATT), TO-226AE
- Minimum Packing Quantity : 1,000 pcs./box

### Marking

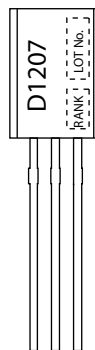

### Electrical Connection

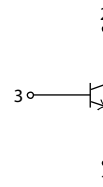

# 2SD1207

## Electrical Characteristics at Ta = 25°C

Parameter	Symbol	Conditions	Ratings			Unit
			min	typ	max	
Collector Cutoff Current	ICBO	V <sub>CB</sub> =50V, I <sub>E</sub> =0A			0.1	μA
Emitter Cutoff Current	IEBO	V <sub>EB</sub> =4V, I <sub>C</sub> =0A			0.1	μA
DC Current Gain	hFE1	V <sub>CE</sub> =2V, I <sub>C</sub> =100mA	140		400	
	hFE2	V <sub>CE</sub> =2V, I <sub>C</sub> =1.5A	40			
Gain-Bandwidth Product	f <sub>T</sub>	V <sub>CE</sub> =10V, I <sub>C</sub> =50mA		150		MHz
Output Capacitance	Cob	V <sub>CB</sub> =10V, f=1MHz		12		pF
Collector to Emitter Saturation Voltage	V <sub>CE(sat)</sub>	I <sub>C</sub> =1A, I <sub>B</sub> =50mA		0.15	0.4	V
Base to Emitter Saturation Voltage	V <sub>BE(sat)</sub>	I <sub>C</sub> =1A, I <sub>B</sub> =50mA		0.9	1.2	V
Collector to Base Breakdown Voltage	V <sub>(BR)CBO</sub>	I <sub>C</sub> =10μA, I <sub>E</sub> =0A	60			V
Collector to Emitter Breakdown Voltage	V <sub>(BR)CEO</sub>	I <sub>C</sub> =1mA, R <sub>BE</sub> =∞	50			V
Emitter to Base Breakdown Voltage	V <sub>(BR)EBO</sub>	I <sub>E</sub> =10μA, I <sub>C</sub> =0A	6			V

\*: The 2SD1207 is graded as follows by hFE at 100mA :

Rank	S	T
hFE	140 to 280	200 to 400

## Ordering Information

Device	Package	Shipping	Memo
2SD1207S	MP	500pcs./bag	Pb Free
2SD1207S-AE		1,000pcs./box	
2SD1207T		500pcs./bag	
2SD1207T-AE		1,000pcs./box	

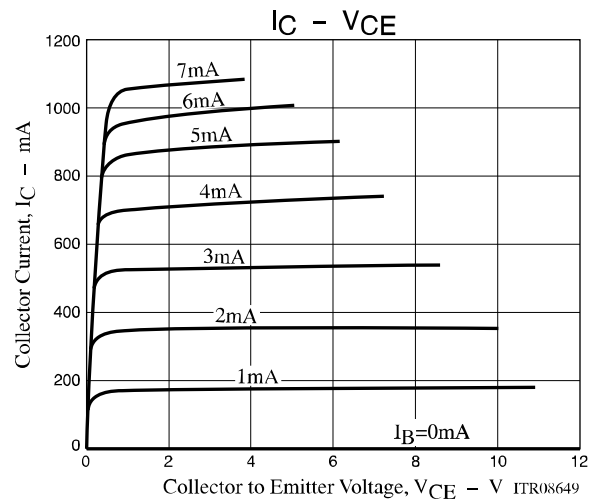
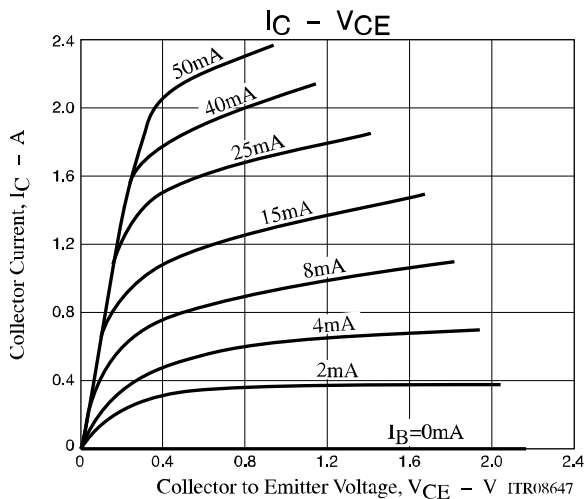

# 2SD1207

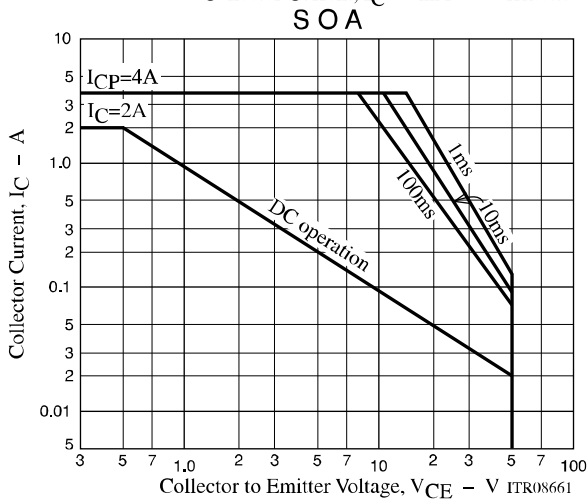
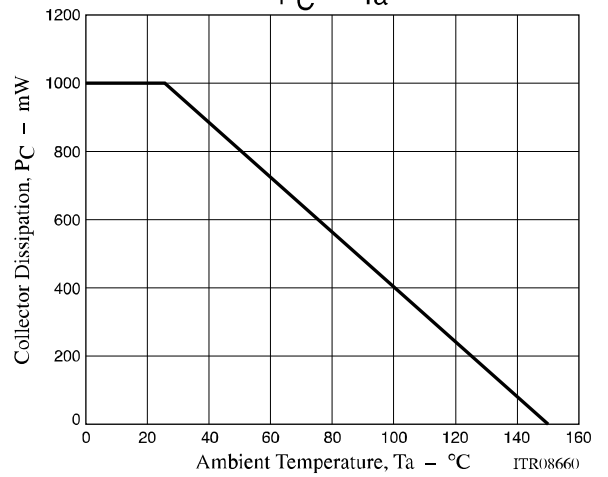
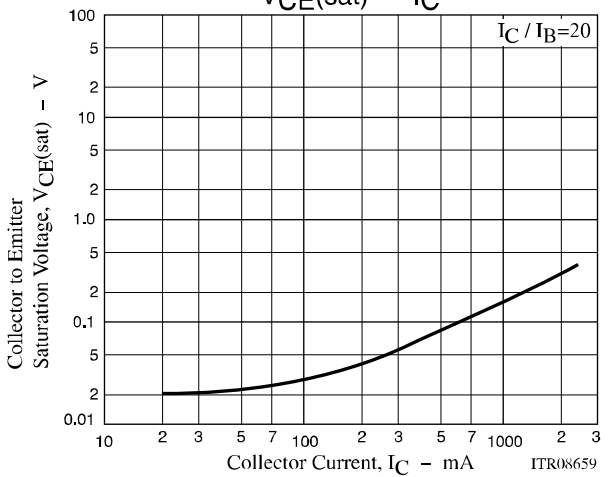
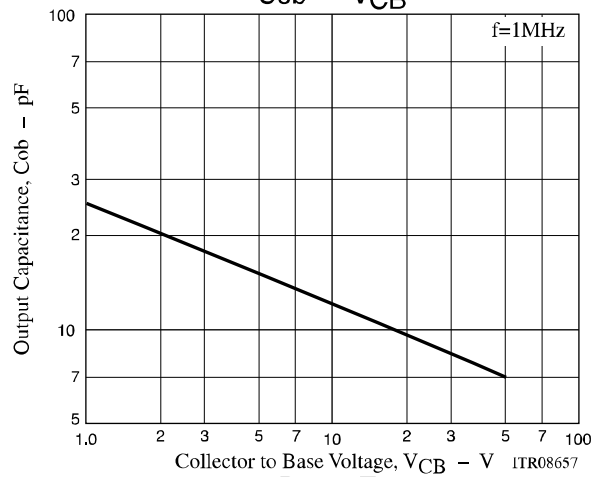
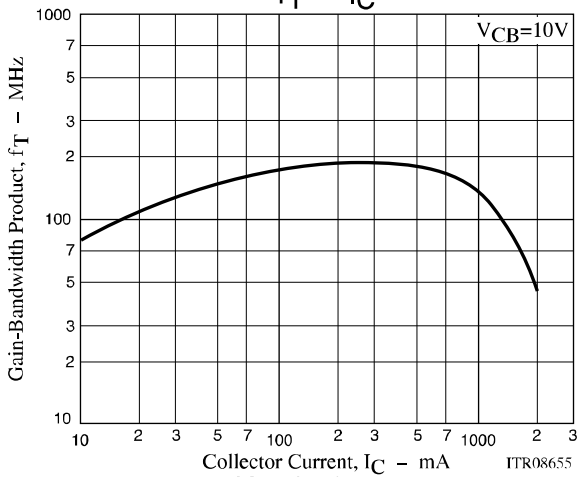
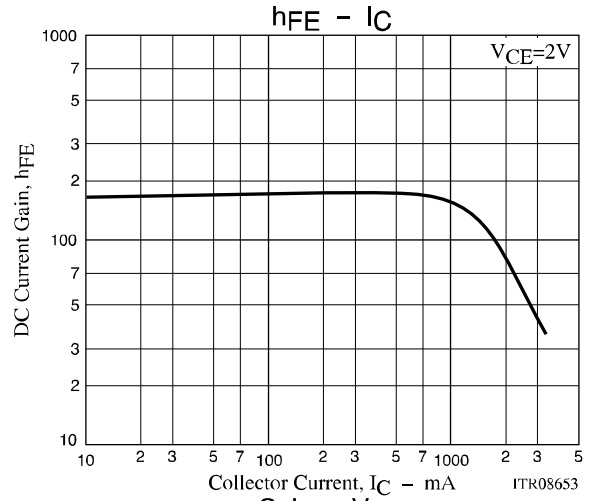
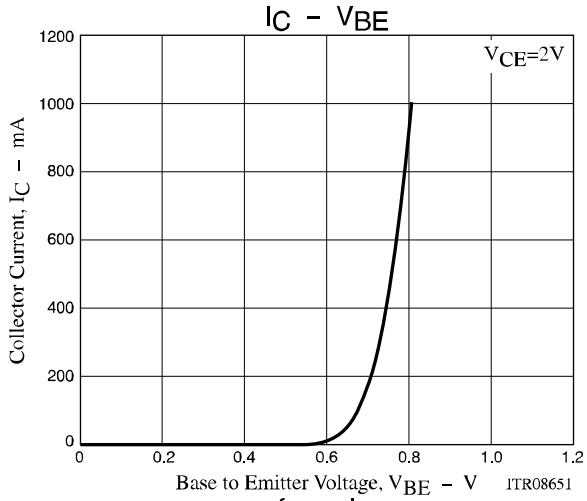

Outline Drawing

2SD1207S-AE

2SD1207T-AE

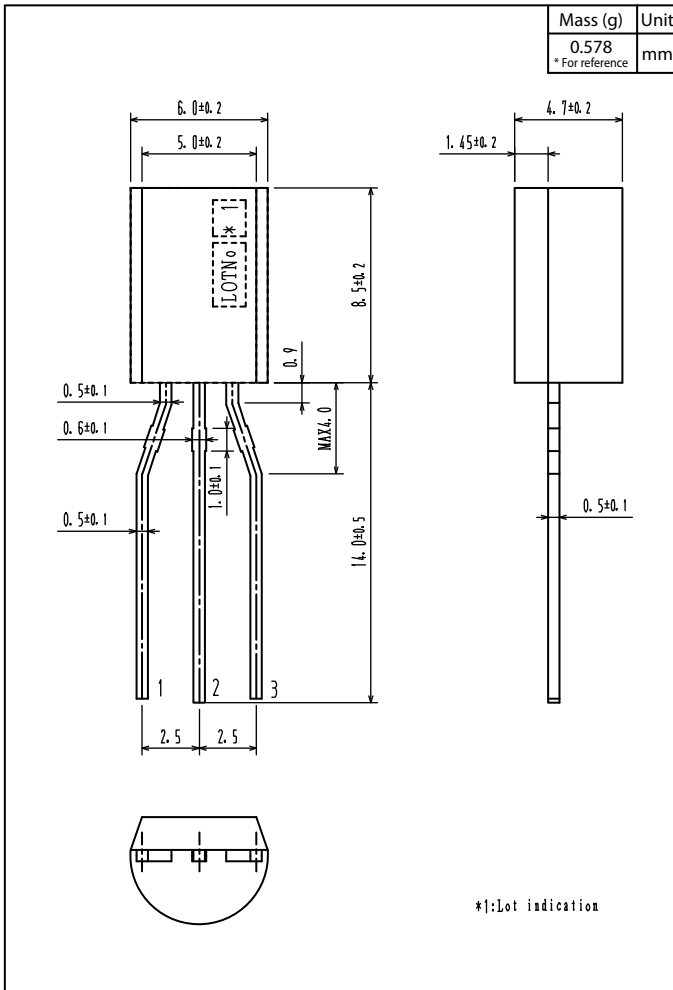

Outline Drawing

2SD1207S

2SD1207T

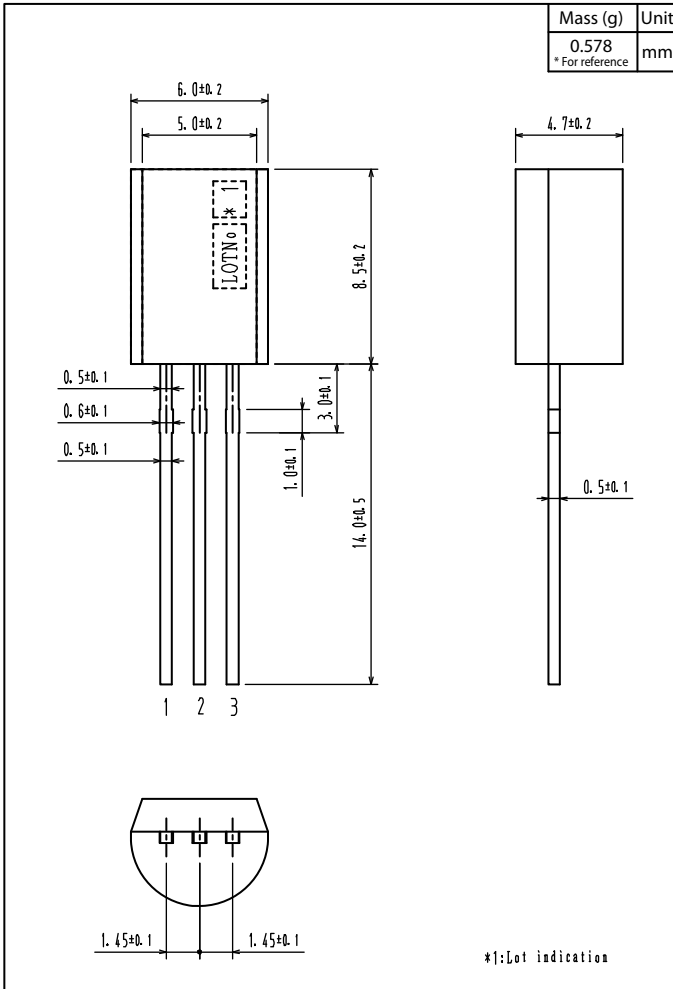

ON Semiconductor and the ON logo are registered trademarks of Semiconductor Components Industries, LLC (SCILLC). SCILLC owns the rights to a number of patents, trademarks, copyrights, trade secrets, and other intellectual property. A listing of SCILLC's product/patent coverage may be accessed at [www.onsemi.com/site/pdf/Patent-Marking.pdf](http://www.onsemi.com/site/pdf/Patent-Marking.pdf). SCILLC reserves the right to make changes without further notice to any products herein. SCILLC makes no warranty, representation or guarantee regarding the suitability of its products for any particular purpose, nor does SCILLC assume any liability arising out of the application or use of any product or circuit, and specifically disclaims any and all liability, including without limitation special, consequential or incidental damages. "Typical" parameters which may be provided in SCILLC data sheets and/or specifications can and do vary in different applications and actual performance may vary over time. All operating parameters, including "Typicals" must be validated for each customer application by customer's technical experts. SCILLC does not convey any license under its patent rights nor the rights of others. SCILLC products are not designed, intended, or authorized for use as components in systems intended for surgical implant into the body, or other applications intended to support or sustain life, or for any other application in which the failure of the SCILLC product could create a situation where personal injury or death may occur. Should Buyer purchase or use SCILLC products for any such unintended or unauthorized application, Buyer shall indemnify and hold SCILLC and its officers, employees, subsidiaries, affiliates, and distributors harmless against all claims, costs, damages, and expenses, and reasonable attorney fees arising out of, directly or indirectly, any claim of personal injury or death associated with such unintended or unauthorized use, even if such claim alleges that SCILLC was negligent regarding the design or manufacture of the part. SCILLC is an Equal Opportunity/Affirmative Action Employer. This literature is subject to all applicable copyright laws and is not for resale in any manner.

## X-ON Electronics

Largest Supplier of Electrical and Electronic Components

*Click to view similar products for [Bipolar Transistors - BJT category](#):*

*Click to view products by [ON Semiconductor manufacturer](#):*

Other Similar products are found below :

[619691C](#) [MCH4017-TL-H](#) [BC546/116](#) [BC557/116](#) [BSW67A](#) [NTE158](#) [NTE187A](#) [NTE195A](#) [NTE2302](#) [NTE2330](#) [NTE63](#) [C4460](#)  
[2SA1419T-TD-H](#) [2SA1721-O\(TE85L,F\)](#) [2SA2126-E](#) [2SB1204S-TL-E](#) [2SC5488A-TL-H](#) [2SD2150T100R](#) [SP000011176](#) [FMMTA92QTA](#)  
[2N2369ADCSM](#) [2SC2412KT146S](#) [2SC5490A-TL-H](#) [2SD1816S-TL-E](#) [2SD1816T-TL-E](#) [CMXT2207 TR](#) [CPH6501-TL-E](#) [MCH4021-TL-E](#)  
[US6T6TR](#) [732314D](#) [CMXT3906 TR](#) [CPH3121-TL-E](#) [CPH6021-TL-H](#) [873787E](#) [UMX21NTR](#) [EMT2T2R](#) [MCH6102-TL-E](#) [FP204-TL-E](#)  
[NJL0302DG](#) [2N3583](#) [2SA1434-TB-E](#) [2SC3143-4-TB-E](#) [2SD1621S-TD-E](#) [NTE103](#) [30A02MH-TL-E](#) [NSV40301MZ4T1G](#) [NTE101](#) [NTE13](#)  
[NTE15](#) [NTE16001](#)