

Schematic for the AR0134CSSC00SUEAH3-GEVB Evaluation Board

Block Diagram

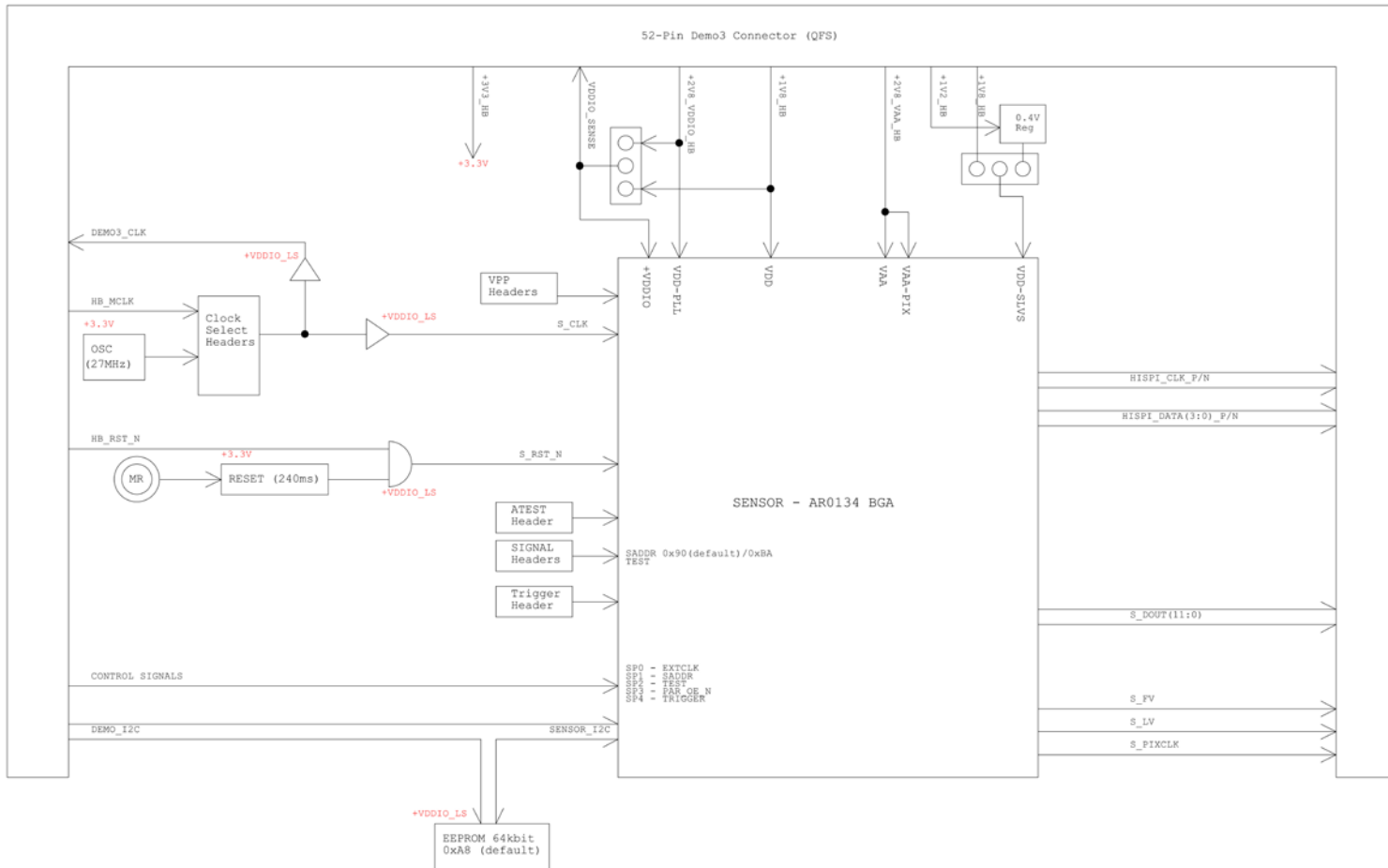

Sensor

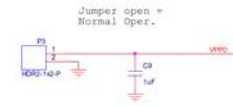
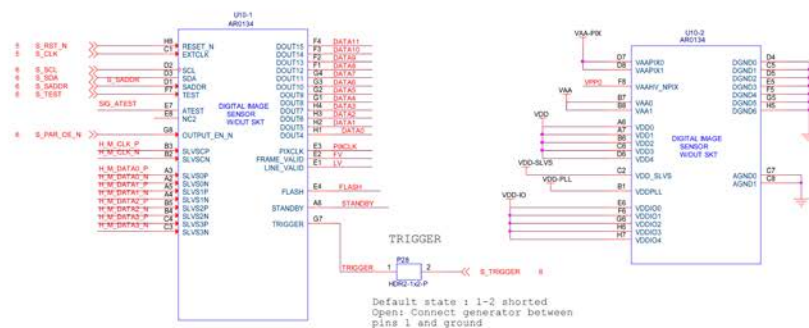

(Note for layout: - Place these testpads near the Dem0 I/F connector at the top side of PCB)

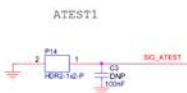
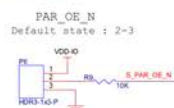
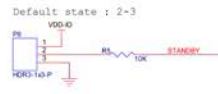
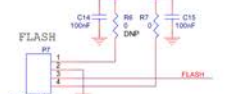

TRIPPOD MOUNT



Debug Headers: Cut away the shorted trace and mount header for power debugging

Power

VDD 1.8V SUPPLY



VDD-SLVS 1.8V SUPPLY

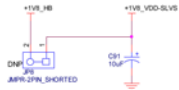

VDD-PLL 2.8V SUPPLY

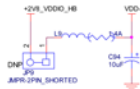

VAA 2.8V SUPPLY

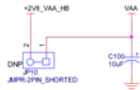

VAA-PIX 2.8V SUPPLY

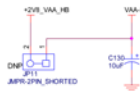

PERIPHERAL 5V SUPPLY

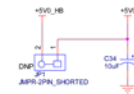

PERIPHERAL 3.3V SUPPLY

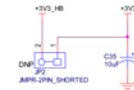

VDDIO & VDDIO LS 1.8V/2.8V SUPPLY

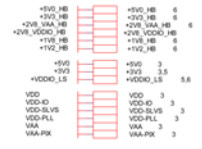
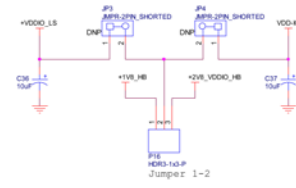

5V LED

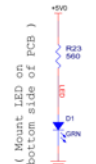

VDDSLVSPHY 0.4V SUPPLY

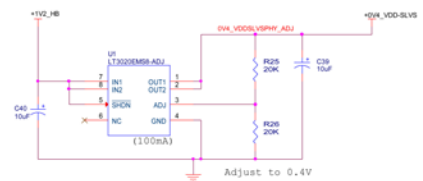

Selection of 0.4V or 1.2V/1V8 for VDDSLVSPHY supply

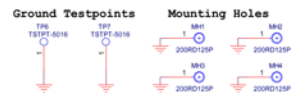
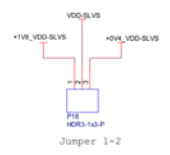

Clock and Reset

+5V0	3.4
+3V3	3.4
+VDDIO_LS	4.6

CLOCK CIRCUIT

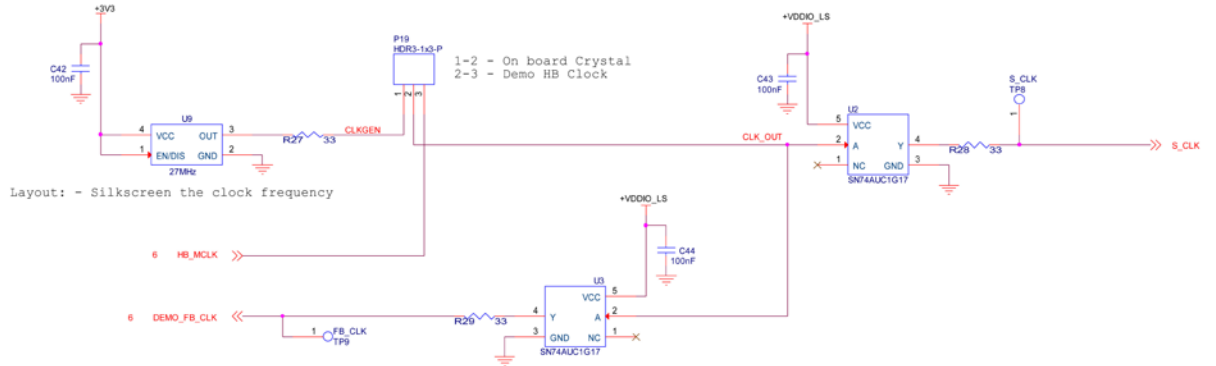

RESET CIRCUIT

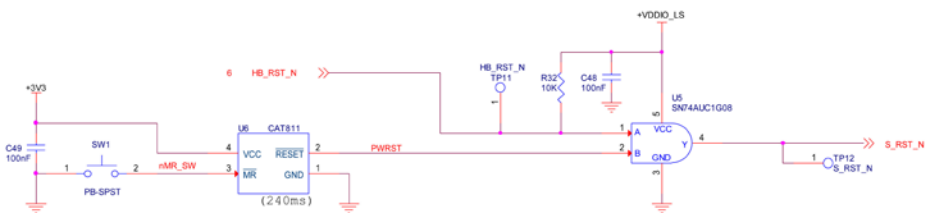

External Interface

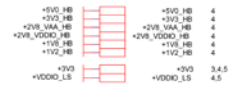

DEMO3 BASEBOARD I/F

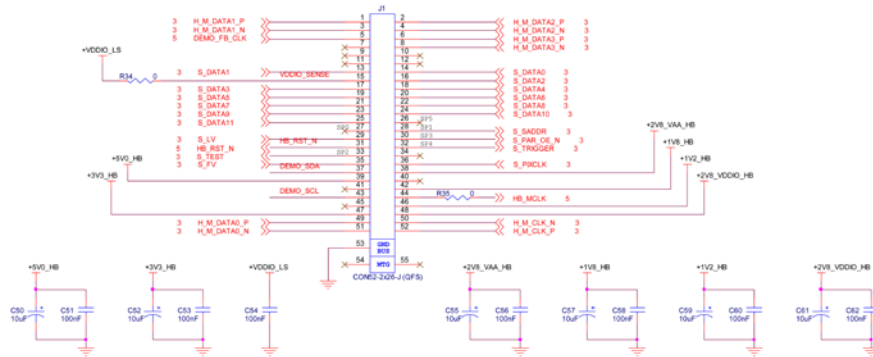

I2C DEBUG

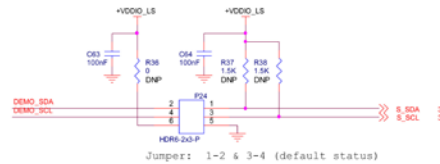

LENS CORRECTION EEPROM

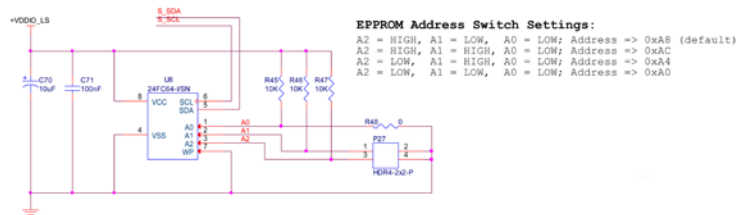

X-ON Electronics

Largest Supplier of Electrical and Electronic Components

Click to view similar products for [Optical Sensor Development Tools](#) category:

Click to view products by [ON Semiconductor](#) manufacturer:

Other Similar products are found below :

[MT9V034C12STCH-GEVB](#) [MT9V115EBKSTCH-GEVB](#) [416015300-3](#) [ISL29102IROZ-EVALZ](#) [MT9M021IA3XTMH-GEVB](#)
[AR1820HSSC12SHQAH3-GEVB](#) [AR1335CSSC11SMKAH3-GEVB](#) [MAXCAMOV10640#](#) [MT9M031I12STMH-GEVB](#) [TSL2581CS-DB](#)
[TMD3700-DB](#) [NANOUSB2.2](#) [ASX340AT3C00XPEDH3-GEVB](#) [AR0144ATSM20XUEAH3-GEVB](#) [AR0144CSSC00SUKAH3-GEVB](#)
[AR0522SRSC09SURAH3-GEVB](#) [AR0522SRSM09SURAH3-GEVB](#) [AR0521SR2C09SURAH3-GEVB](#) [MARS1-MAX9295A-GEVK](#)
[MARS1-MAX9296B-GEVB](#) [ISL29112IROZ-EVALZ](#) [AR0233AT2C17XUEAH3-GEVB](#) [AR0431CSSC14SMRAH3-GEVB](#) [MARS-DEMO3-](#)
[MIPI-GEVB](#) [TCS3430-DB](#) [AR0234CSSC00SUKAH3-GEVB](#) [AR0130CSSM00SPCAH-GEVB](#) [AR0330CM1C00SHAAH3-GEVB](#) [EVALZ-](#)
[ADPD2212](#) [TMD2772EVM](#) [TMG3993EVM](#) [MIKROE-2103](#) [TSL2672EVM](#) [1384](#) [MT9M114EBLSTCZDH-GEVB](#) [SEN0043](#) [SEN0162](#)
[TMD2771EVM](#) [TMD3782EVM](#) [TSL4531EVM](#) [1918](#) [AS7225](#) [DEMO KIT](#) [SEN0097](#) [SEN0212](#) [SEN0228](#) [AR0134CSSC00SUEAH3-GEVB](#)
[AP0100AT2L00XUGAH3-GEVB](#) [AR0144CSSM20SUKAH3-GEVB](#) [725-28915](#) [EVAL-ADPD1081Z-PPG](#)