

**ON Semiconductor®**



## **Schematic for the AR0135 Evaluation Board**



# AR0135\_BGA\_Demo3Head

Page	Description
1	Title Page
2	Block Diagram
3	Sensor
4	Power
5	Clock and Reset
6	External Interfaces

Rev	Who	Date	Description
Rev 0.0	aralex	05/07/14	Initial
Rev 0.0	aralex	05/08/14	Removed the 10nF Decaps on VDD and VDDIO for Sensor
		05/13/14	Updated the sensor with the new non socketed part, and added C-mount lens
		05/15/14	Updated the sensor with the new non socketed part, and added the socket for demo3 board
Rev 0.1	aralex	05/16/14	Removed text near R8 for TRIGGER signal Replaced R25 with a fixed resistor of 20K
	aralex	05/20/14	Removed Skip Block Fiducials FD4 and FD8.
Rev 1.0	aralex	04/23/15	Added a 2 pin header P28 for Trigger signal, deleted R8

# Block Diagram

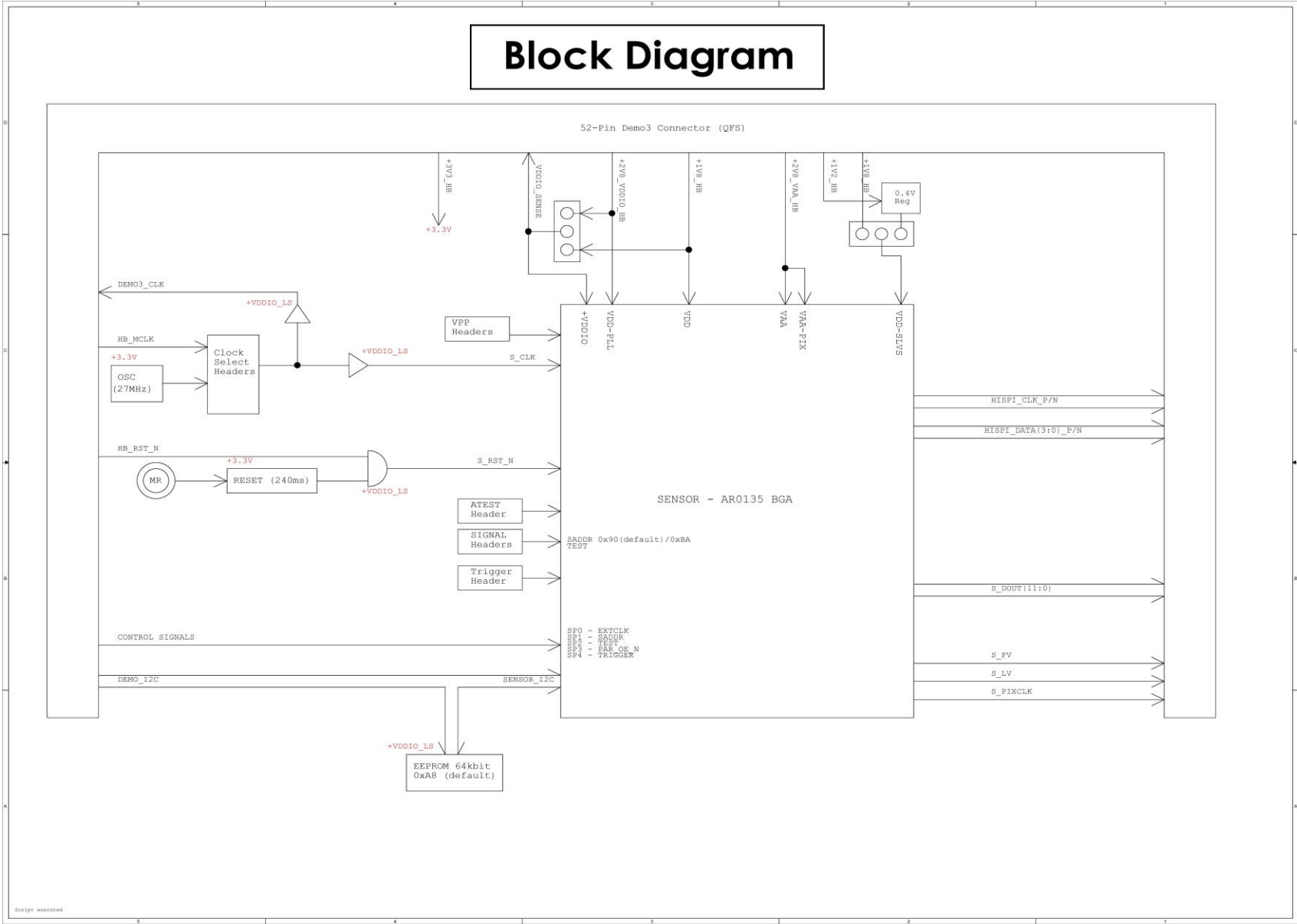



# Sensor

+SVD	4	+SVD	4
+VIO	4.5	+VIO	4.5
+VDDIO_LS	4.5.6	+VDDIO_LS	4.5.6
VDD	4	VDD	4
VDD-ID	4	VDD-ID	4
VDD-SLVS	4	VDD-SLVS	4
VDD-PLL	4	VDD-PLL	4
VAA	4	VAA	4
VAA-PK	4	VAA-PK	4

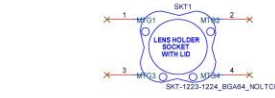
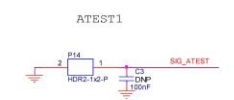
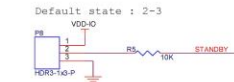
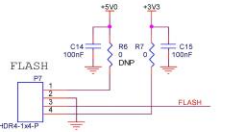
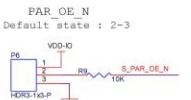
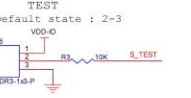
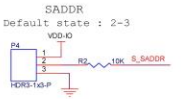
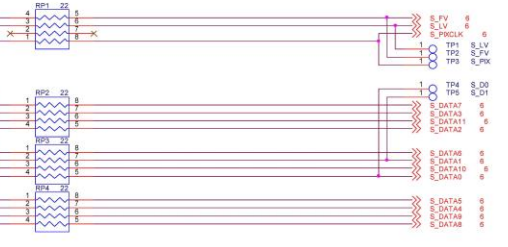
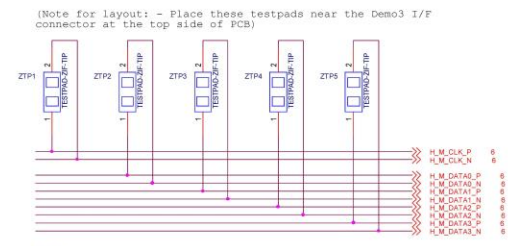
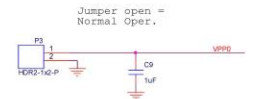
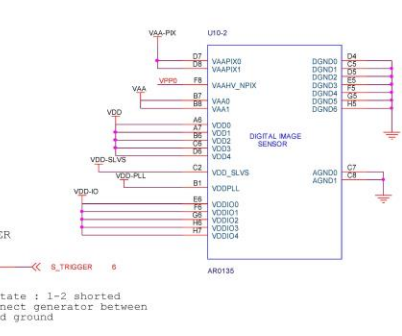
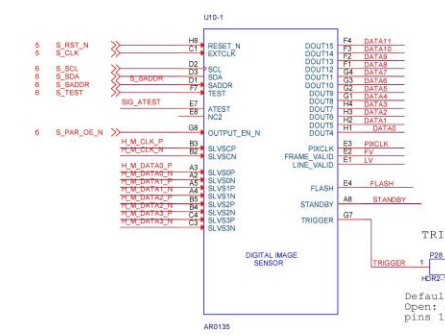

Debug Headers: Cut away the shorted trace and mount header for power debugging

# Power

## VDD 1.8V SUPPLY

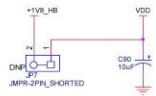

## VDD-SLVS 1.8V SUPPLY

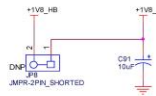

## VDD-PLL 2.8V SUPPLY

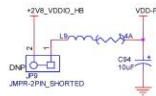

## VAA 2.8V SUPPLY

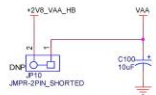

## VAA-PIX 2.8V SUPPLY

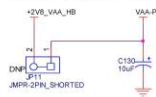

## PERIPHERAL 5V SUPPLY

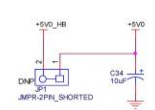

## PERIPHERAL 3.3V SUPPLY

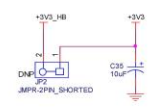

## VDDIO & VDDIO LS 1.8V/2.8V SUPPLY

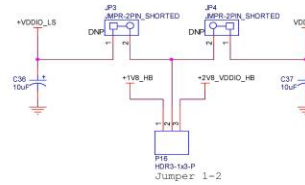

+5V0_HB	+5V0_HB	8
+3V3_HB	+3V3_HB	6
+2V8_VAA_HB	+2V8_VAA_HB	6
+2V8_VDDIO_HB	+2V8_VDDIO_HB	6
+1V8_HB	+1V8_HB	6
+1V2_HB	+1V2_HB	6
+5V0	+5V0	3
+3V3	+3V3	3,5
+VDDIO_LS	+VDDIO_LS	5,8
VDD	VDD	3
VDD-ID	VDD-ID	3
VDD-SLVS	VDD-SLVS	3
VDD-PLL	VDD-PLL	3
VAA	VAA	3
VAA-PIX	VAA-PIX	3

## 5V LED

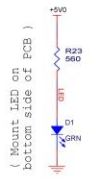

## VDDSLVSPHY 0.4V SUPPLY

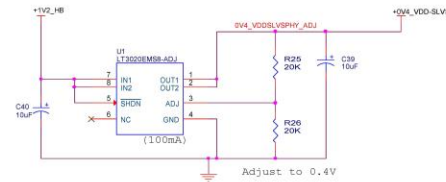

Selection of 0.4V or 1.2V/1V8 for VDDSLVSPHY supply

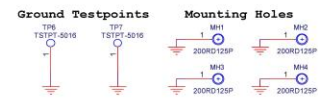
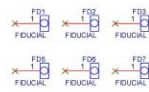
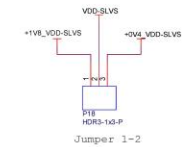

# Clock and Reset

+5V0	3.4
+3V3	3.4
+VDD0_L5	4.8

## CLOCK CIRCUIT

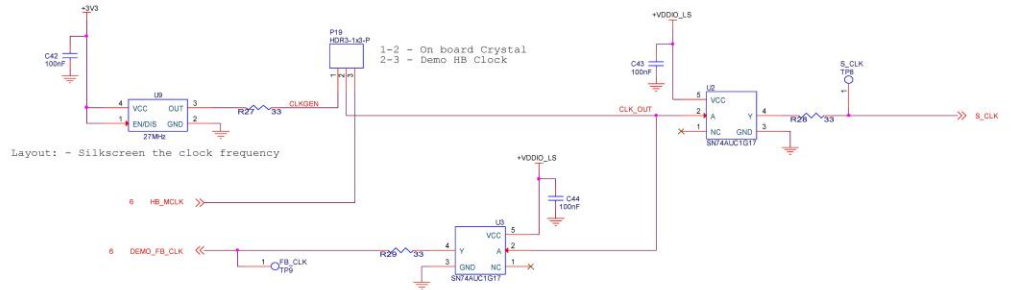

## RESET CIRCUIT

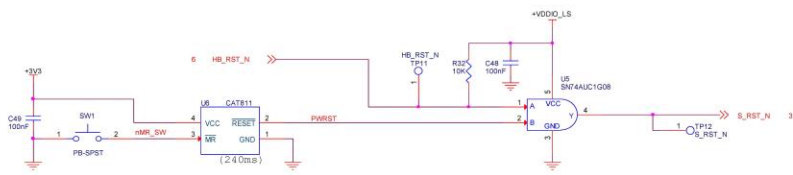

# External Interface

+5V0_HB	4	+5V0_HB	4
+5V0_HB	4	+2V8_HB	4
+2V8_VAA_HB	4	+3V0_VAA_HB	4
+2V8_VDDIO_HB	4	+2V8_VDDIO_HB	4
+1V2_HB	4	+1V2_HB	4
+1V2_HB	4	+1V2_HB	4
+3V3	3,4,5	+3V3	3,4,5
+VDDIO_LS	4,5	+VDDIO_LS	4,5

## DEMO3 BASEBOARD I/F

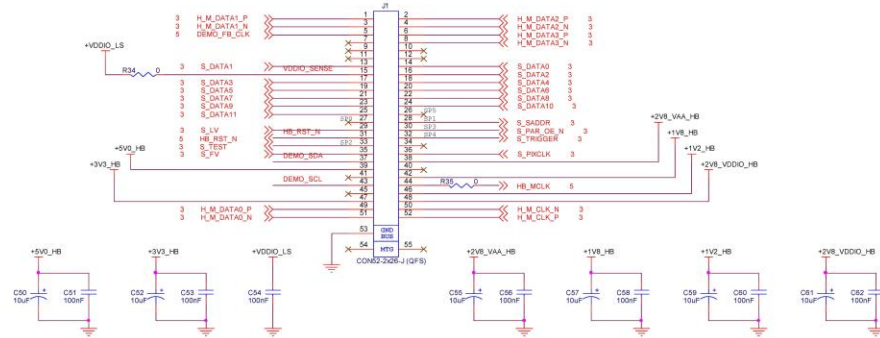

## I2C DEBUG

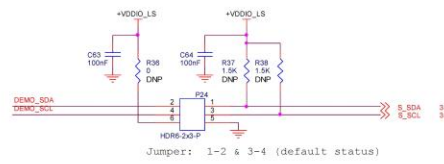

## LENS CORRECTION EEPROM

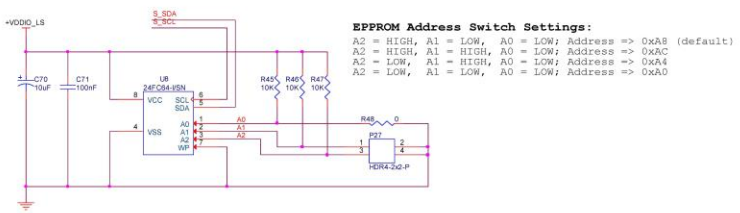

## X-ON Electronics

Largest Supplier of Electrical and Electronic Components

*Click to view similar products for [Optical Sensor Development Tools](#) category:*

*Click to view products by [ON Semiconductor](#) manufacturer:*

Other Similar products are found below :

[MT9V034C12STCH-GEVB](#) [MT9V115EBKSTCH-GEVB](#) [416015300-3](#) [ISL29102IROZ-EVALZ](#) [MT9M021IA3XTMH-GEVB](#)  
[AR1820HSSC12SHQAH3-GEVB](#) [AR1335CSSC11SMKAH3-GEVB](#) [MAXCAMOV10640#](#) [MT9M031I12STMH-GEVB](#) [TSL2581CS-DB](#)  
[TMD3700-DB](#) [NANOUSB2.2](#) [ASX340AT3C00XPEDH3-GEVB](#) [AR0144ATSM20XUEAH3-GEVB](#) [AR0144CSSC00SUKAH3-GEVB](#)  
[AR0522SRSC09SURAH3-GEVB](#) [AR0522SRSM09SURAH3-GEVB](#) [AR0521SR2C09SURAH3-GEVB](#) [MARS1-MAX9295A-GEVK](#)  
[MARS1-MAX9296B-GEVB](#) [ISL29112IROZ-EVALZ](#) [AR0233AT2C17XUEAH3-GEVB](#) [AR0431CSSC14SMRAH3-GEVB](#) [MARS-DEMO3-](#)  
[MIPI-GEVB](#) [TCS3430-DB](#) [AR0234CSSC00SUKAH3-GEVB](#) [AR0130CSSM00SPCAH-GEVB](#) [AR0330CM1C00SHAAH3-GEVB](#) [EVALZ-](#)  
[ADPD2212](#) [TMD2772EVM](#) [TMG3993EVM](#) [MIKROE-2103](#) [TSL2672EVM](#) [1384](#) [MT9M114EBLSTCZDH-GEVB](#) [SEN0043](#) [SEN0162](#)  
[TMD2771EVM](#) [TMD3782EVM](#) [TSL4531EVM](#) [1918](#) [AS7225](#) [DEMO KIT](#) [SEN0097](#) [SEN0212](#) [SEN0228](#) [AR0134CSSC00SUEAH3-GEVB](#)  
[AP0100AT2L00XUGAH3-GEVB](#) [AR0144CSSM20SUKAH3-GEVB](#) [725-28915](#) [EVAL-ADPD1081Z-PPG](#)