

Silicon Photomultiplier (SiPM) High Fill-Factor Arrays

ArrayJ Series

onsemi's range of J-Series SiPM sensors have been used to create high fill-factor, scalable arrays. The sensors are mounted onto PCB boards with minimal dead space, forming arrays with industry-leading fill factor of up to 90%.

The back of each ArrayJ has either one or more multi-way connectors, or a BGA (ball grid array). These allow access to the fast output* and standard I/O from each pixel in the array, and a common I/O from the summed substrates of the pixels.

The ArrayJ products with connectors can be used to interface with the user's own readout via a mating connector, or to a onsemi Breakout Board (BOB). The BOBs allow for easy access to the pixel signals and performance evaluation of the arrays.

ArrayJ products with the BGA can be reflow soldered to the user's readout boards, or purchased ready-mounted on a pinned PCB evaluation board for easy testing. A BGA ArrayJ cannot be removed from its PCB evaluation board. This contrasts with an ArrayJ with connectors, as multiple arrays can be evaluated with a single BOB.

ArrayJ Inputs and Outputs (I/O)

Figure 1 summarizes the array schematic for a portion of an ArrayJ. Each SiPM sensor in the array has three electrical connections: fast output, standard output and common.

The substrates (cathodes) of all sensors are summed together to form the common I/O.

Each individual fast output and standard I/O (anode) are routed to its own output pin.

The pixel-level performance of the sensors in the array can be found in the [J-Series datasheet](#).

Table of Contents

ARRAYJ-60035-64P-PCB (8 X 8 Array of 6 mm Pixels)	2
ARRAYX-BOB6-64P (Breakout Board for the ARRAYJ-60035-64P)	5
ARRAYX-BOB6-64S (Summed Breakout Board for the ARRAYJ-60035-64P)	7
ARRAYJ-60035-4P-BGA (2 X 2 Array of 6 mm Pixels)	9
ARRAYJ-60035-4P-PCB (2 X 2 Array of 6 mm Pixels)	12
ARRAYJ-300XX-16P-PCB (4 X 4 Array of 3 mm Pixels)	17
ARRAYJ-BOB3-16P (ARRAYJ-300XX-16P Breakout Board)	19
ARRAYJ-300XX-64P-PCB (8 X 8 Array of 3 mm Pixels)	21
ARRAYJ-BOB3-64P (ARRAYJ-300XX-64P & ARRAYJ-40035-64P Breakout Board)	25
Biasing and Readout from the Standard Breakout Boards	27
Appendix A	29
Appendix B	30
Appendix C	31
Ordering Information	32

* The fast output is not available on the 2x2 array (ARRAYJ-60035-4P).

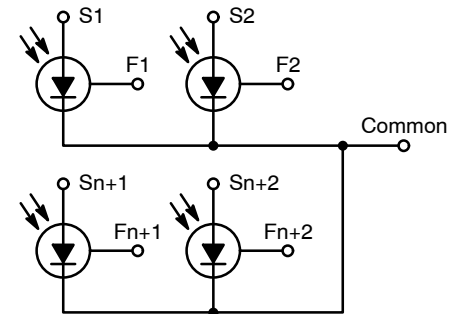
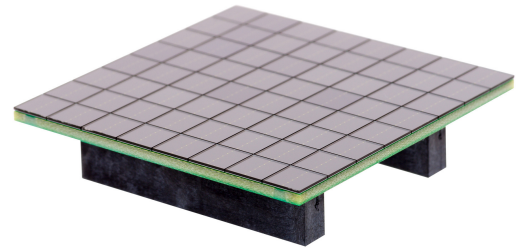

Figure 1. Signal connections at the pixel level on the ArrayJ products.

ATTENTION!

Great care should be taken when disconnecting the ArrayJ PCBs from the mating connectors, either on one of the BOBs, or the user's own boards.

The board should be gently levered up, working progressively around the board to lever the PCB from the connector a little on all sides, and then repeating the process until the connectors are free from each other.

Use of Scintillators with the ArrayJ Products

Please consult the [Application Note](#) on the use of scintillators with the TSV arrays.

ArrayJ Series

ARRAYJ-60035-64P-PCB (8 X 8 Array of 6 mm Pixels)

Array Size	Sensor Type	Readout	Board Size	Pixel Pitch	No. Connections	No. Connectors
8 x 8	60035	Pixel	50.44 x 50.44 mm ²	6.33 mm	160	2 x 80-way

The ARRAYJ-60035-64P is comprised of 64 individual 6 mm J-Series sensors arranged in a 8 x 8 array.

The performance of the individual pixels and details of the bias to apply can be found in the [J-Series datasheet](#).

The connections to each array are provided by two Samtec 80-way connectors, type QTE-040-03-F-D-A. These connectors mate with the Samtec QSE-040-01-F-D-A board-to-board connector and the Samtec EQCD High Speed Cable Assemblies. The 64 SiPM pixels all have substrate connections (cathode) summed to form a common I/O. The 80-way connectors provide connections as follows:

- 64 x fast output
- 64 x standard I/O
- 32 x common I/O
- 16 x shield contacts to the Common

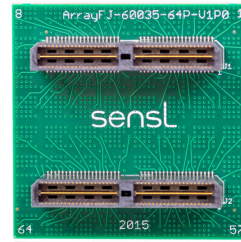
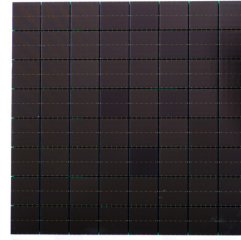

ARRAYJ-60035-64P Board Drawing

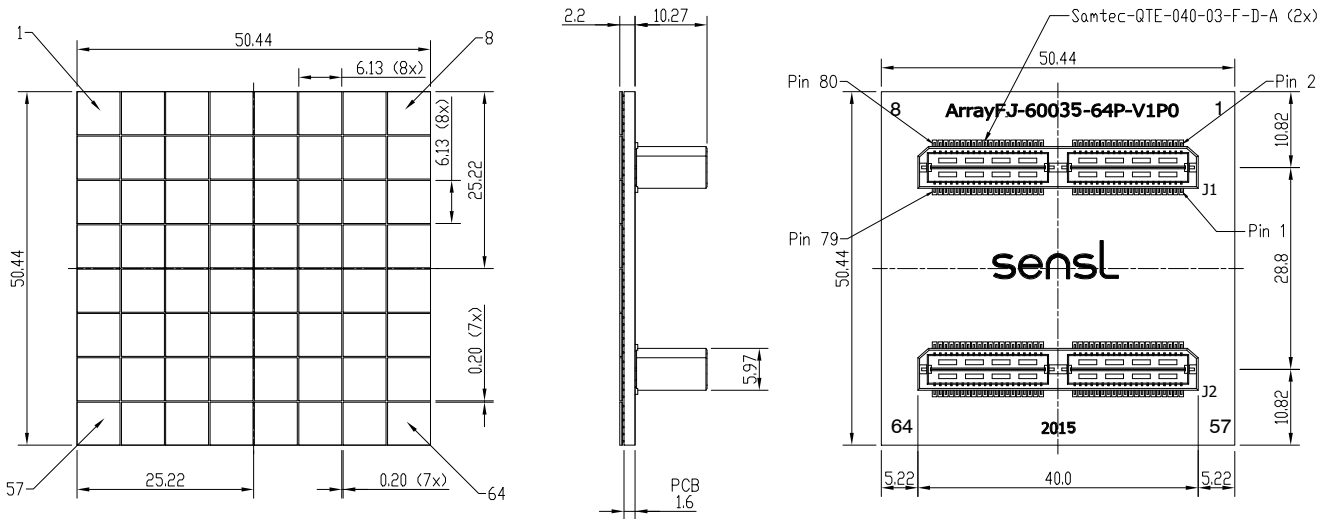

The complete ARRAYJ-60035-64P-PCB CAD is available to [download](#).

ArrayJ Series

Connector Schematic for the ARRAYJ-60035-64P-PCB

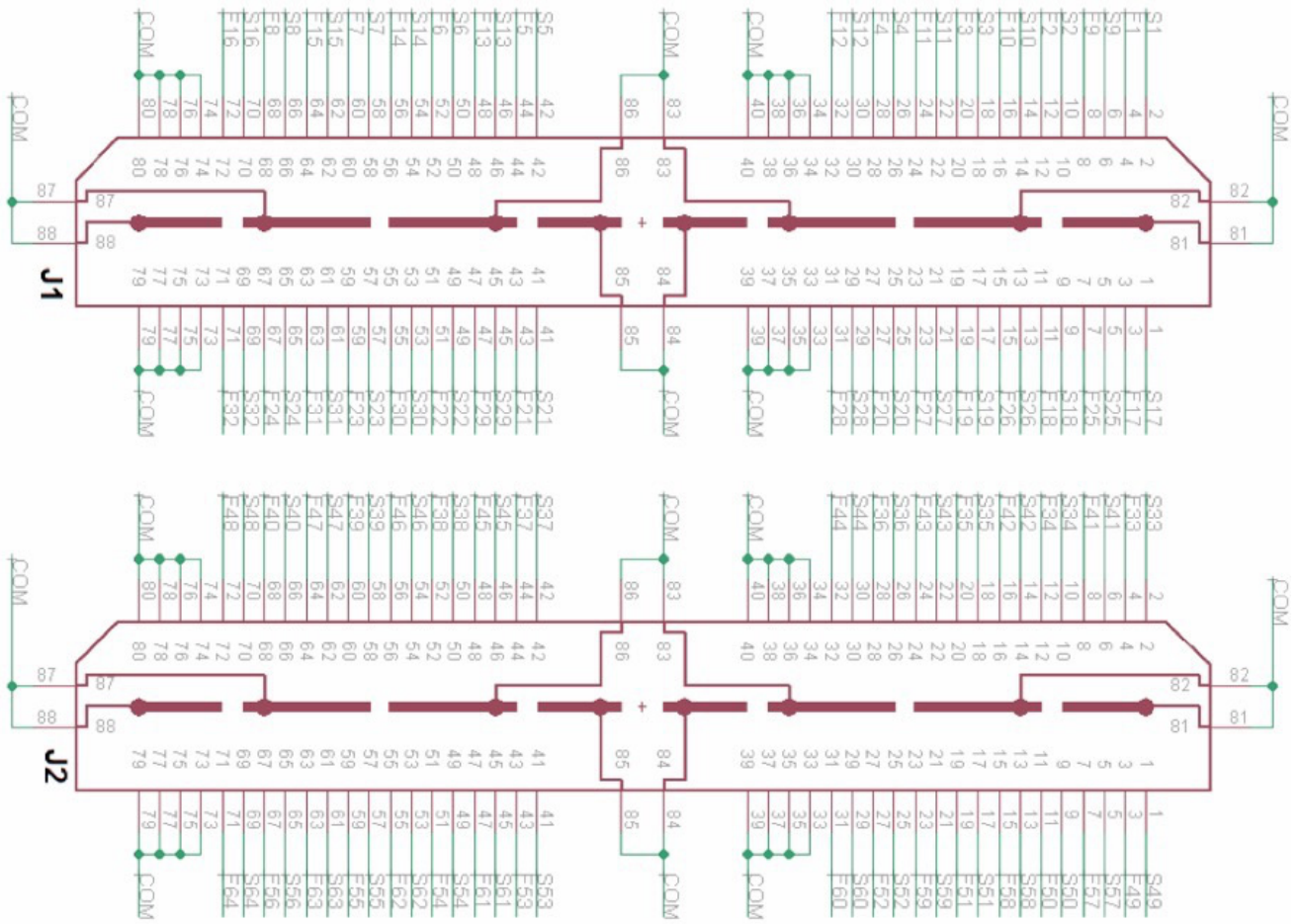

Figure 2. Connector schematic for the ARRAYJ-60035-64P

The connector location and array pixel numbering is indicated on the array schematics on the previous page.

ArrayJ Series

Table 1. CONNECTOR PIN-OUTS FOR THE ARRAYJ-60035-64P-PCB

J1				J2			
PIN	SIGNAL	PIN	SIGNAL	PIN	SIGNAL	PIN	SIGNAL
1	S17	2	S1	1	S49	2	S33
3	F17	4	F1	3	F49	4	F33
5	S25	6	S9	5	S57	6	S41
7	F25	8	F9	7	F57	8	F41
9	S18	10	S2	9	S50	10	S34
11	F18	12	F2	11	F50	12	F34
13	S26	14	S10	13	S58	14	S42
15	F26	16	F10	15	F58	16	F42
17	S19	18	S3	17	S51	18	S35
19	F19	20	F3	19	F51	20	F35
21	S27	22	S11	21	S59	22	S43
23	F27	24	F11	23	F59	24	F43
25	S20	26	S4	25	S52	26	S36
27	F20	28	F4	27	F52	28	F36
29	S28	30	S12	29	S60	30	S44
31	F28	32	F12	31	F60	32	F44
33	CM	34	CM	33	CM	34	CM
35	CM	36	CM	35	CM	36	CM
37	CM	38	CM	37	CM	38	CM
39	CM	40	CM	39	CM	40	CM
41	S21	42	S5	41	S53	42	S37
43	F21	44	F5	43	F53	44	F37
45	S29	46	S13	45	S61	46	S45
47	F29	48	F13	47	F61	48	F45
49	S22	50	S6	49	S54	50	S38
51	F22	52	F6	51	F54	52	F38
53	S30	54	S14	53	S62	54	S46
55	F30	56	F14	55	F62	56	F46
57	S23	58	S7	57	S55	58	S39
59	F23	60	F7	59	F55	60	F39
61	S31	62	S15	61	S63	62	S47
63	F31	64	F15	63	F63	64	F47
65	S24	66	S8	65	S56	66	S40
67	F24	68	F8	67	F56	68	F40
69	S32	70	S16	69	S64	70	S48
71	F32	72	F16	71	F64	72	F48
73	CM	74	CM	73	CM	74	CM
75	CM	76	CM	75	CM	76	CM
77	CM	78	CM	77	CM	78	CM
79	CM	80	CM	79	CM	80	CM

CM	Common I/O
Sn	Standard I/O of pixel n
Fn	Fast output of pixel n

ArrayJ Series

ARRAYX-BOB6-64P (Breakout Board for the ARRAYJ-60035-64P)

The ARRAYX-BOB6-64P is an evaluation board allowing easy access to all the signals of a **onsemi** ARRAYJ-60035-64P, 6 mm 8 x 8 TSV SiPM array.

The Breakout Board features two Samtec 80-way connectors, type QSE-040-01-F-D-A. These connectors mate with the Samtec QTE-040-03-F-D-A board-to-board connector on the array. Since the connectors are keyed, orientating the array on the BOB is straight-forward.

All signals on the array are routed via the mating connectors to header pins. These pins are formed of four 50-way (25 x 2 row) 2.54 mm pitch headers; J3, J4, J5 and J6. Each of the four headers also has 8 pins left unconnected to allow prototyping for evaluation purposes.

The three SMA connectors on the board can be connected via the supplied jumper cable to any of the array header pins and used for accessing signals or supplying bias voltage. Four 7 mm holes are aligned on a 25 mm grid to allow mounting of the board on an optical breadboard.

See Appendices A and B for examples of Breakout Board usage.

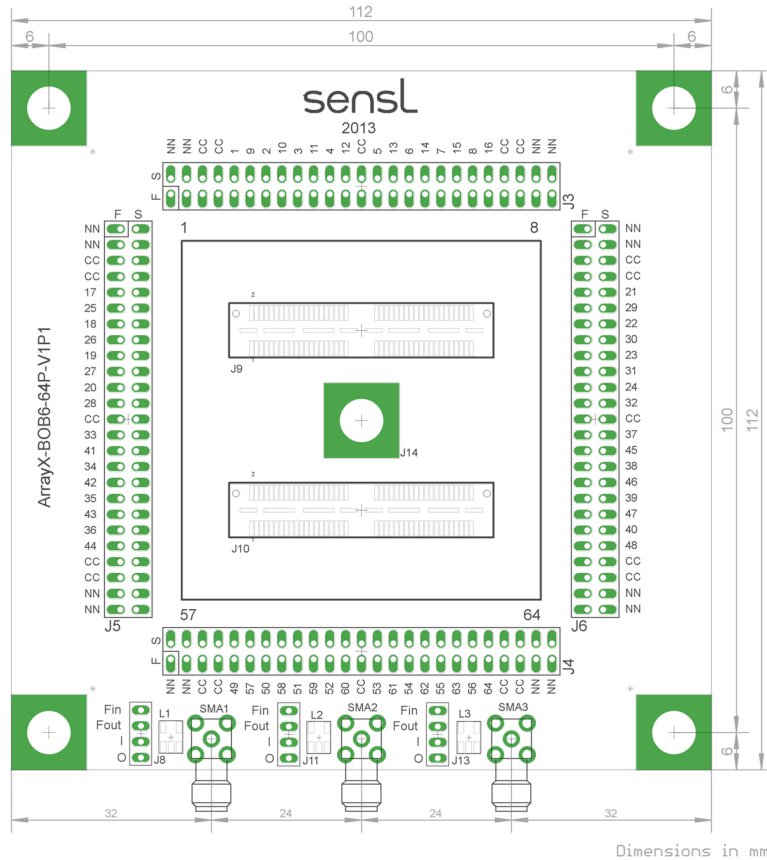
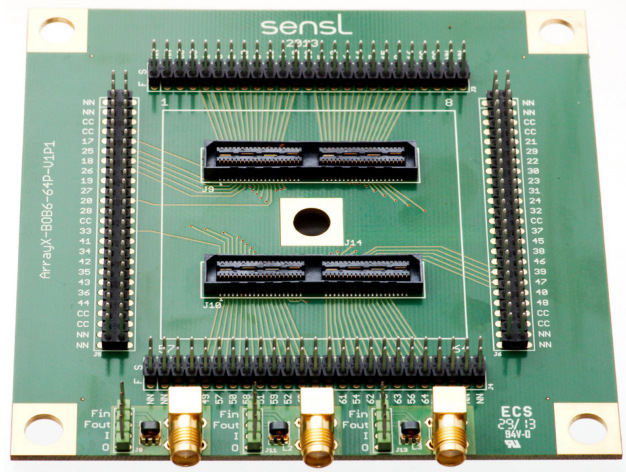

Figure 3. Layout of the ARRAYX-BOB6-64P. The dimensions of the board are 112 mm x 112 mm.

ArrayJ Series

Table 2. HEADER SIGNALS ON THE ARRAYX-BOB6-64P

Pin		J3		J4		J5		J6	
1	2	NC	NC	NC	NC	NC	NC	NC	NC
3	4	NC	NC	NC	NC	NC	NC	NC	NC
5	6	CM	CM	CM	CM	CM	CM	CM	CM
7	8	CM	CM	CM	CM	CM	CM	CM	CM
9	10	F1	S1	F49	S49	F17	S17	F21	S21
11	12	F9	S9	F57	S57	F25	S25	F29	S29
13	14	F2	S2	F50	S50	F18	S18	F22	S22
15	16	F10	S10	F58	S58	F26	S26	F30	S30
17	18	F3	S3	F51	S51	F19	S19	F23	S23
19	20	F11	S11	F59	S59	F27	S27	F31	S31
21	22	F4	S4	F52	S52	F20	S20	F24	S24
23	24	F12	S12	F60	S60	F28	S28	F32	S32
25	26	CM	CM	CM	CM	CM	CM	CM	CM
27	28	F5	S5	F53	S53	F33	S33	F37	S37
29	30	F13	S13	F61	S61	F41	S41	F45	S45
31	32	F6	S6	F54	S54	F34	S34	F38	S38
33	34	F14	S14	F62	S62	F42	S42	F46	S46
35	36	F7	S7	F55	S55	F35	S35	F39	S39
37	38	F15	S15	F63	S63	F43	S43	F47	S47
39	40	F8	S8	F56	S56	F36	S36	F40	S40
41	42	F16	S16	F64	S64	F44	S44	F48	S48
43	44	CM	CM	CM	CM	CM	CM	CM	CM
45	46	CM	CM	CM	CM	CM	CM	CM	CM
47	48	NC	NC	NC	NC	NC	NC	NC	NC
49	50	NC	NC	NC	NC	NC	NC	NC	NC

NC	Not Connected
CM	Common I/O
Sn	Standard I/O of pixel n
Fn	Fast output of pixel n

ArrayJ Series

ARRAYX-BOB6-64S (Summed Breakout Board for the ARRAYJ-60035-64P)

The ARRAYX-BOB6-64S is an evaluation board allowing easy access to the sum of all of standard pixel signals of a **onsemi** ARRAYJ-60035-64P, 6 mm 8 x 8 TSV array, in addition to all of the individual fast output signals. The Breakout Board features two Samtec 80-way connectors, type QSE-040-01-F-D-A. These connectors mate with the Samtec QTE-040-03-F-D-A board-to-board connector on the array. Since the connectors are keyed, orientating the array on the BOB is straightforward. A schematic of the board is shown in Figure 4 below.

Fast signals: All of the fast output signals (Fn) from the array are routed via the mating connectors to header pins. These pins are formed of four 50-way (25 x 2 row) 2.54 mm

pitch headers; J3, J4, J5 and J6. Each of the four headers also has 10 pins that connect to the common cathode (CM) and 8 pins left unconnected (NC) to allow prototyping for evaluation purposes.

Two SMA connectors and Balun transformers are provided with 4-pin headers to allow any fast signal to be connected directly to the SMA or via the transformer using jumper wires.

Summed output: A summed output (the anodes of pixels 1 to 64 connected together) is routed to jumper pins (SM) in close proximity to a third SMA connector. Four 7 mm holes are placed on a 25 mm grid to allow mounting of the board on an optical breadboard.

See Appendix C for an example of the use of the summed BOB.

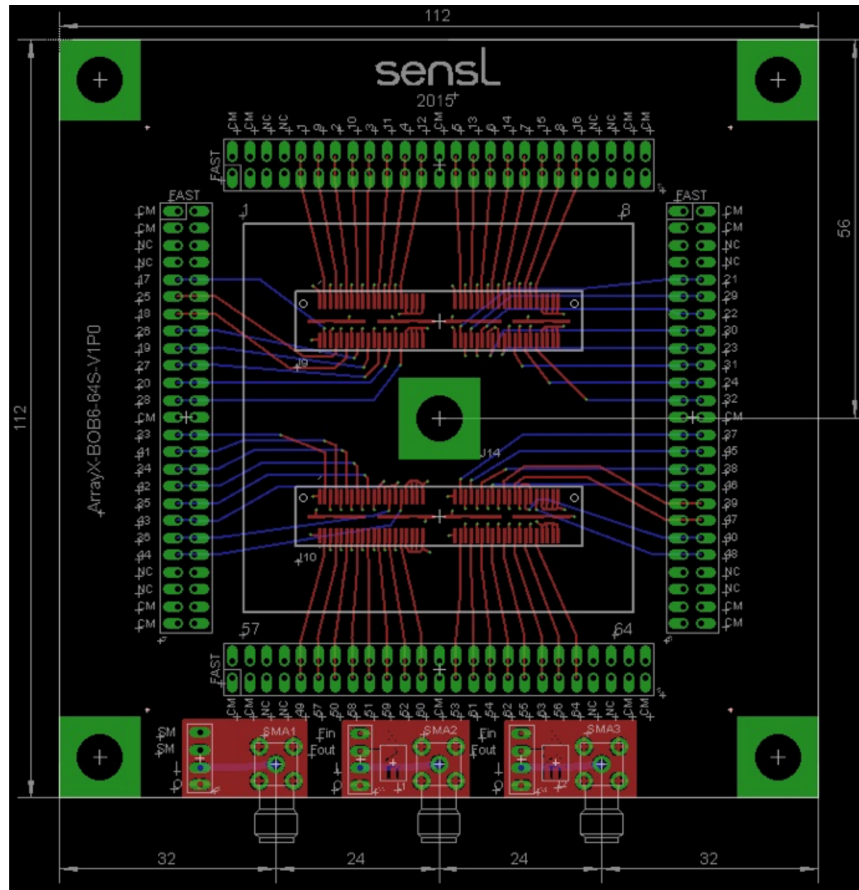

Figure 4. Layout of the ARRAYX-BOB6-64P. The dimensions of the board are 112 mm x 112 mm.

ArrayJ Series

Table 3. HEADER SIGNALS ON THE ARRAYX-BOB6-64S

Pin		J3		J4		J5		J6	
1	2	CM	CM	CM	CM	CM	CM	CM	CM
3	4	CM	CM	CM	CM	CM	CM	CM	CM
5	6	NC	NC	NC	NC	NC	NC	NC	NC
7	8	NC	NC	NC	NC	NC	NC	NC	NC
9	10	F1	F1	F49	F49	F17	F17	F21	F21
11	12	F9	F9	F57	F57	F25	F25	F29	F29
13	14	F2	F2	F50	F50	F18	F18	F22	F22
15	16	F10	F10	F58	F58	F26	F26	F30	F30
17	18	F3	F3	F51	F51	F19	F19	F23	F23
19	20	F11	F11	F59	F59	F27	F27	F31	F31
21	22	F4	F4	F52	F52	F20	F20	F24	F24
23	24	F12	F12	F60	F60	F28	F28	F32	F32
25	26	CM	CM	CM	CM	CM	CM	CM	CM
27	28	F5	F5	F53	F53	F33	F33	F37	F37
29	30	F13	F13	F61	F61	F41	F41	F45	F45
31	32	F6	F6	F54	F54	F34	F34	F38	F38
33	34	F14	F14	F62	F62	F42	F42	F46	F46
35	36	F7	F7	F55	F55	F35	F35	F39	F39
37	38	F15	F15	F63	F63	F43	F43	F47	F47
39	40	F8	F8	F56	F56	F36	F36	F40	F40
41	42	F16	F16	F64	F64	F44	F44	F48	F48
43	44	NC	NC	NC	NC	NC	NC	NC	NC
45	46	NC	NC	NC	NC	NC	NC	NC	NC
47	48	CM	CM	CM	CM	CM	CM	CM	CM
49	50	CM	CM	CM	CM	CM	CM	CM	CM

NC	Not Connected
CM	Common I/O
Fn	Fast output of pixel n

ArrayJ Series

ARRAYJ-60035-4P-BGA (2 X 2 Array of 6 mm Pixels)

Array Size	Sensor Type	Readout	Board Size	Pixel Pitch	No. Connections	No. Connectors
2 x 2	60035	Pixel	12.64 x 12.64 mm ²	6.33 mm	9	3 x 3 BGA

The ARRAYJ-60035-4P is comprised of 4 individual 6 mm J-Series sensors arranged in a 2 x 2 array.

The performance of the individual pixels and details of the bias to apply can be found in the [J-Series datasheet](#).

Connections to each sensor are provided by a BGA (ball grid array). The BGA can be reflow soldered onto the user's own readout board.

The 4 SiPM sensors have all substrate connections (cathodes) connected together to form a common I/O. The 3 x 3 BGA provides connections as follows:

- 4 x standard I/O
- 5 x common I/O
- There is NO fast output

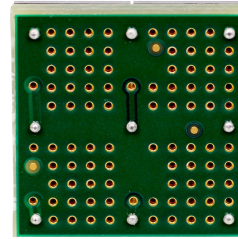
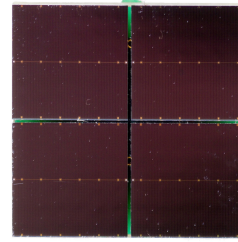

ARRAYJ-60035-4P-BGA Board Dimensions and Pin Location

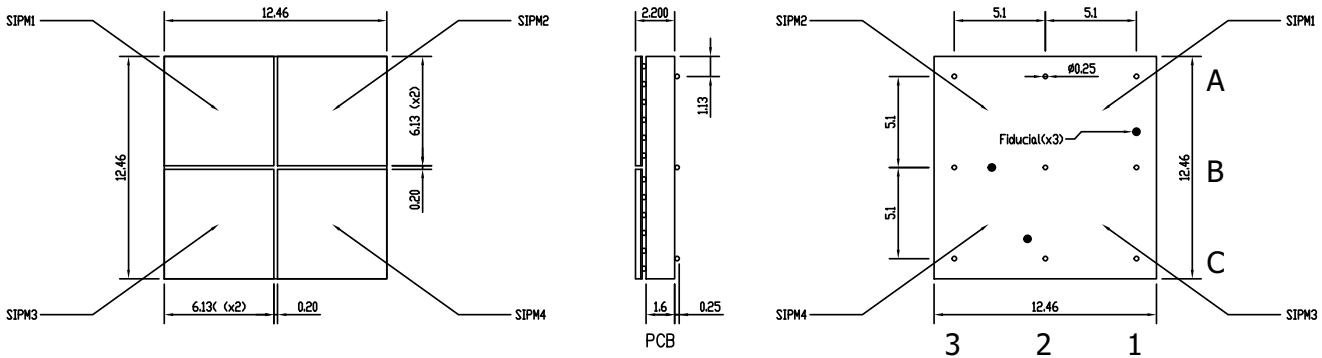

The complete ARRAYJ-60035-4P-BGA CAD and solder footprint is available to [download](#).

ArrayJ Series

BGA Connections for the ARRAYJ-60035-4P-BGA

The fiducial is indicated in the image below. It marks the location of both pin A1 and pixel 1.

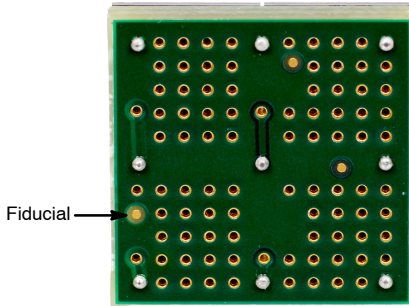

Pin. No	Function
A1	Anode 1
A2	Anode 2
A3	Common Cathode
B1	Anode 3
B2	Anode 4
B3	Common Cathode
C1	Common Cathode
C2	Common Cathode
C3	Common Cathode

ARRAYJ-60035-4P-BGA – Solder Footprint and Reflow Solder Profile

The BGA package is compatible with standard reflow solder processes (J-STD-20) and so is ideal for high-volume manufacturing.

The ARRAYJ-60035-4P-BGA should be mounted according to specified soldering pad patterns, as shown in Figure 5 and in the CAD file which can be downloaded here. The solder pads may be oversized to ease placement of the carrier on the PCB. Consult with your contract manufacturer

for recommendation based upon placement accuracy capability.

Solder paste (**onsemi** recommend using no-clean solder paste) must be evenly applied to each soldering pad to insure proper bonding and positioning of the array. After soldering, allow at least three minutes for the component to cool to room temperature before further operations.

Solder reflow conditions must be in compliance with J-STD-20, table 5.2. This is summarized in Figure 6. The number of passes should not be more than 2.

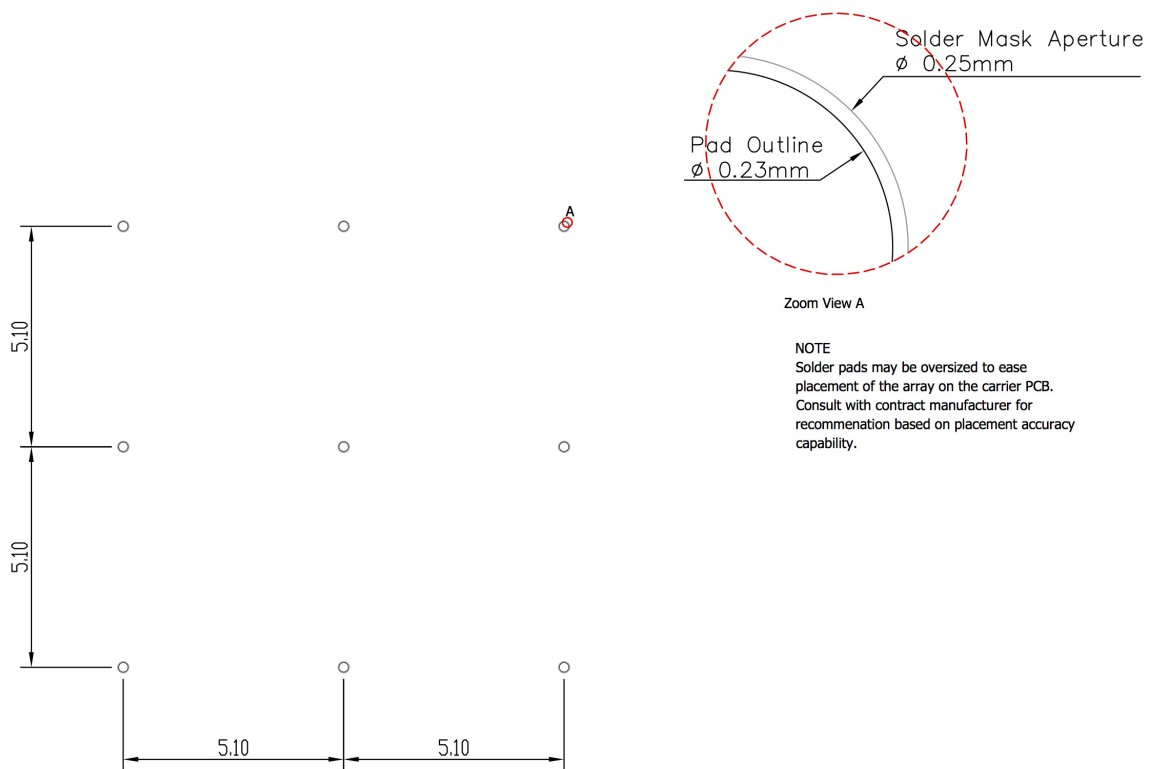

Figure 5. Recommended solder footprint for use with the ARRAYJ-60035-4P-BGA

ArrayJ Series

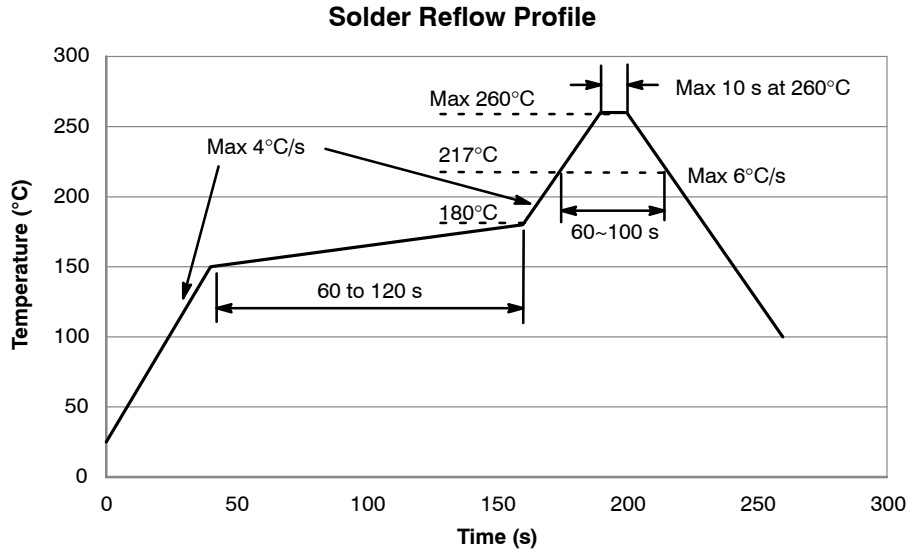

Figure 6. Solder reflow profile. Conditions must be in compliance with J-STD-20, table 5.2.

ArrayJ Series

ARRAYJ-60035-4P-PCB (2 x 2 Array of 6 mm Pixels)

The ARRAYJ-60035-4P-PCB is an evaluation board allowing easy access to the signals of a ARRAYJ-60035-4P-BGA via pins.

The ARRAYJ-60035-4P-PCB has the array on the front and pins on the back of the PCB. The pins are compatible with a standard 8-pin DIL socket for evaluation purposes. Alternatively, the pins can be directly soldered into through-holes in the user's readout PCB. Four of the pins are connected to the anodes of the individual pixels and the other four pins are connected to the common cathode. An example mating 8-pin DIL socket is the [110-93-308-41-001000 from Mill-Max](#).

The ARRAYJ-60035-4P-PCB does NOT provide access to the fast output.

ARRAYJ-60035-4P-PCB Pin-Outs

Pin. No	Function
1	Anode 1
2	Common Cathode
3	Anode 3
4	Common Cathode
5	Common Cathode
6	Anode 4
7	Common Cathode
8	Anode 2

The location of the pin 1 indicator is shown on the image on the right.

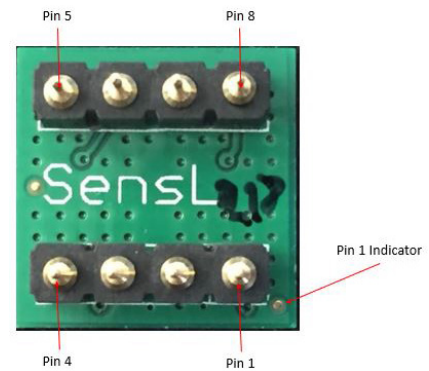
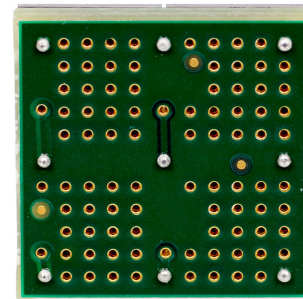
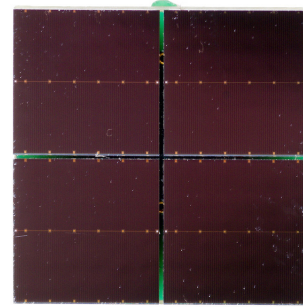

ARRAYJ-60035-4P-PCB Board Dimensions and Pin Locations

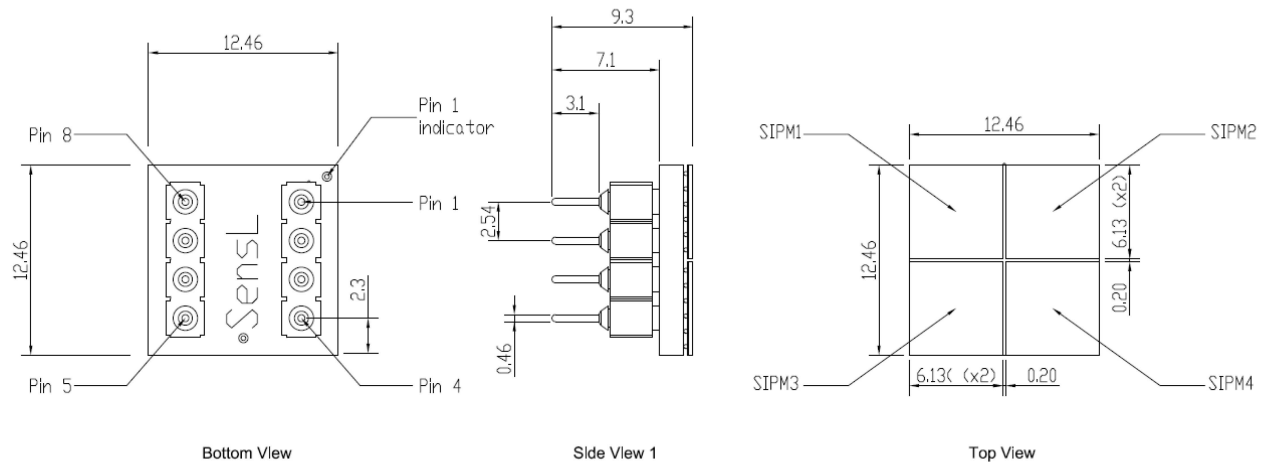

The complete ARRAYJ-60035-4P-PCB CAD is available to [download](#).

ArrayJ Series

ARRAYJ-40035-64P-PCB (8 X 8 Array of 4 mm Pixels)

Array Size	Sensor Type	Readout	Board Size	Pixel Pitch	No. Connections	No. Connectors
8 x 8	40035	Pixel	33.4 x 33.4 mm ²	4.2 mm	160	2 x 80-way

The ARRAYJ-40035-64P is comprised of 64 individual 4 mm J-Series sensors arranged in a 8 x 8 array. The performance of the individual pixels and details of the bias to apply can be found in the [J-Series datasheet](#).

Connections to each sensor are provided by two Hirose 80-way connectors, type DF17(2.0)-80DP-0.5v(57). These connectors mate with the Hirose DF17(2.0)-80DS-0.5v(57) board-to-board connectors. The 64 SiPM sensors have all substrate connections (cathodes) connected together to form a common I/O. The 2 x 80-way connectors provide connections as follows:

- 64 x fast output
- 64 x standard I/O
- 32 x common I/O
- 4 x shield contacts to the Common

ARRAYJ-40035-64P Breakout Board

The breakout board for the ARRAYJ-40035-64P-PCB is the same as for the ARRAYJ-300XX-64P-PCB; the ARRAYJ-BOB3-64P. Please see page 25 for details.

ARRAYJ-40035-64P-PCB Board Drawing

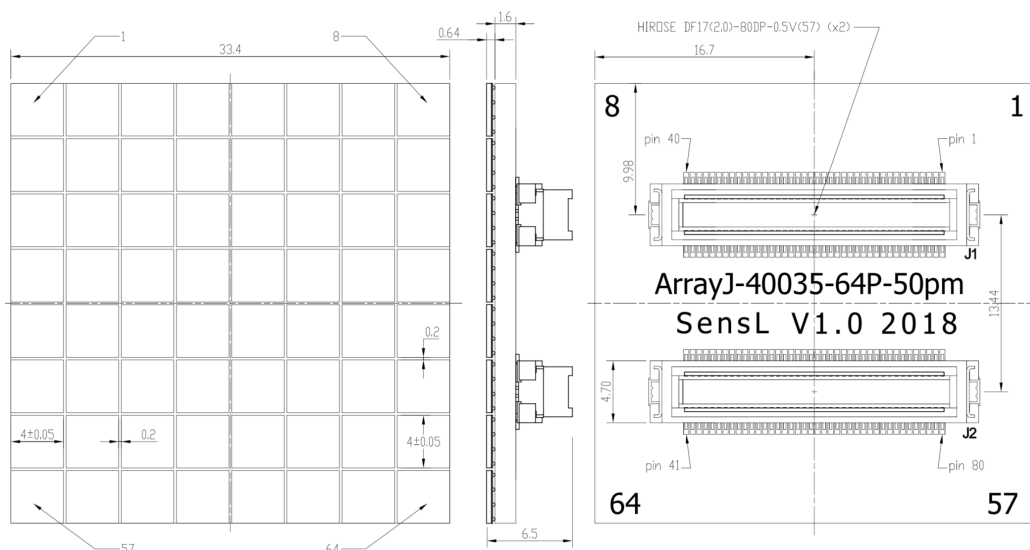

The complete ARRAYJ-40035-64P-PCB CAD is available to [download](#).

ArrayJ Series

Connector Schematics for the ARRAYJ-40035-64P

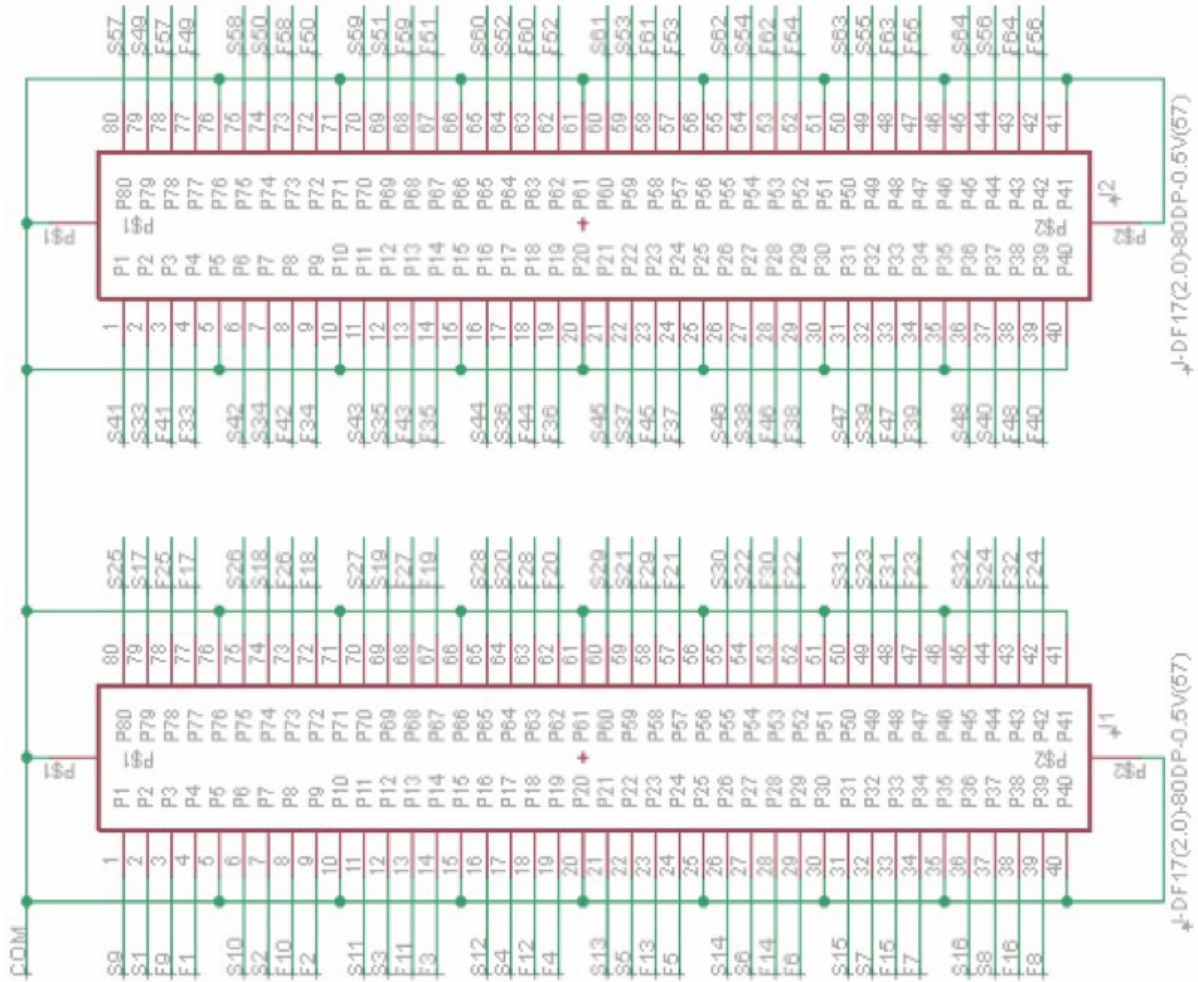

Figure 7. Schematic of the ARRAYJ-40035-64P connectors.

ArrayJ Series

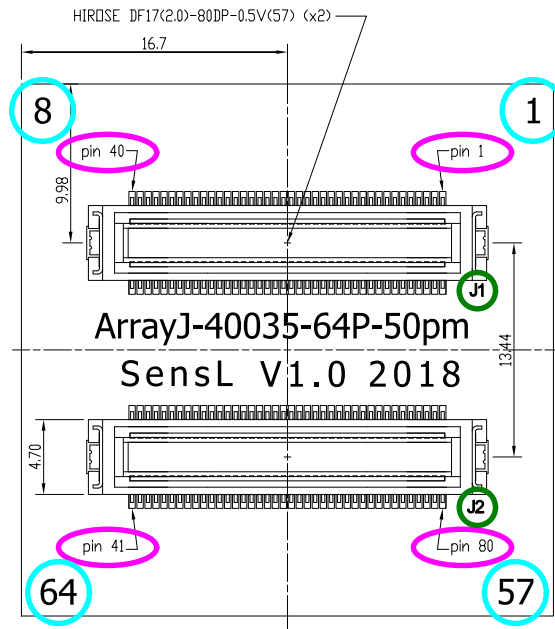

Figure 8. Highlighting the location of the connector, pin and array pixel numbering on the ARRAYJ-40035-64P.

ArrayJ Series

Table 4. CONNECTOR PIN-OUTS FOR THE ARRAYJ-40035-64P

J1				J2			
PIN	SIGNAL	PIN	SIGNAL	PIN	SIGNAL	PIN	SIGNAL
1	S9	2	S1	1	S41	2	S33
3	F9	4	F1	3	F41	4	F33
5	CM	6	S10	5	CM	6	S42
7	S2	8	F10	7	S34	8	F42
9	F2	10	CM	9	F34	10	CM
11	S11	12	S3	11	S43	12	S35
13	F11	14	F3	13	F43	14	F35
15	CM	16	S12	15	CM	16	S44
17	S4	18	F12	17	S36	18	F44
19	F4	20	CM	19	F36	20	CM
21	S13	22	S5	21	S45	22	S37
23	F13	24	F5	23	F45	24	F37
25	CM	26	S14	25	CM	26	S46
27	S6	28	F14	27	S38	28	F46
29	F6	30	CM	29	F38	30	CM
31	S15	32	S7	31	S47	32	S39
33	F15	34	F7	33	F47	34	F39
35	CM	36	S16	35	CM	36	S48
37	S8	38	F16	37	S40	38	F48
39	F8	40	CM	39	F40	40	CM
41	CM	42	F24	41	CM	42	F56
43	F32	44	S24	43	F64	44	S56
45	S32	46	CM	45	S64	46	CM
47	F23	48	F31	47	F55	48	F63
49	S23	50	S31	49	S55	50	S63
51	CM	52	F22	51	CM	52	F54
53	F30	54	S22	53	F62	54	S54
55	S30	56	CM	55	S62	56	CM
57	F21	58	F29	57	F53	58	F61
59	S21	60	S29	59	S53	60	S61
61	CM	62	F20	61	CM	62	F52
63	F28	64	S20	63	F60	64	S52
65	S28	66	CM	65	S60	66	CM
67	F19	68	F27	67	F51	68	F59
69	S19	70	S27	69	S51	70	S59
71	CM	72	F18	71	CM	72	F50
73	F26	74	S18	73	F58	74	S50
75	S26	76	CM	75	S58	76	CM
77	F17	78	F25	77	F49	78	F57
79	S17	80	S25	79	S49	80	S57

CM	Common I/O
Sn	Standard I/O of pixel n
Fn	Fast output of pixel n

ArrayJ Series

ARRAYJ-300XX-16P-PCB (4 X 4 Array of 3 mm Pixels)

Array Size	Sensor Type	Readout	Board Size	Pixel Pitch	No. Connections	No. Connectors
4 x 4	30035	Pixel	13.24 x 13.24 mm ²	3.36 mm	40	2 x 20-way
	30020					

The ARRAYJ-300XX-16P is comprised of 16 individual 3 mm J-Series sensors arranged in a 4 x 4 array. There are two types: The ARRAYJ-30035-16P has pixels which are formed of 35 um microcells, and the ARRAYJ-30020-16P has pixels that are formed of 20 um microcells.

The performance of the individual pixels and details of the bias to apply can be found in the [J-Series datasheet](#).

Connections to each sensor are provided by two 20-way Hirose plug-type board-to-board connectors, DF17(2.0)-20DP-0.5V(57). These connectors mate with the Hirose DF17(3.0)-20DS-0.5V(57). The 16 SiPM pixels have all substrates (cathodes) connected together to form a common I/O. The 20-way connector provides connections as follows:

- 16 x fast output
- 16 x standard I/O
- 8 x common I/O
- 4 x shield contacts to the Common

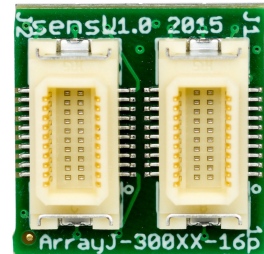
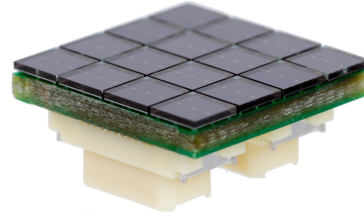

ARRAYJ-300XX-16P-PCB Board Drawing

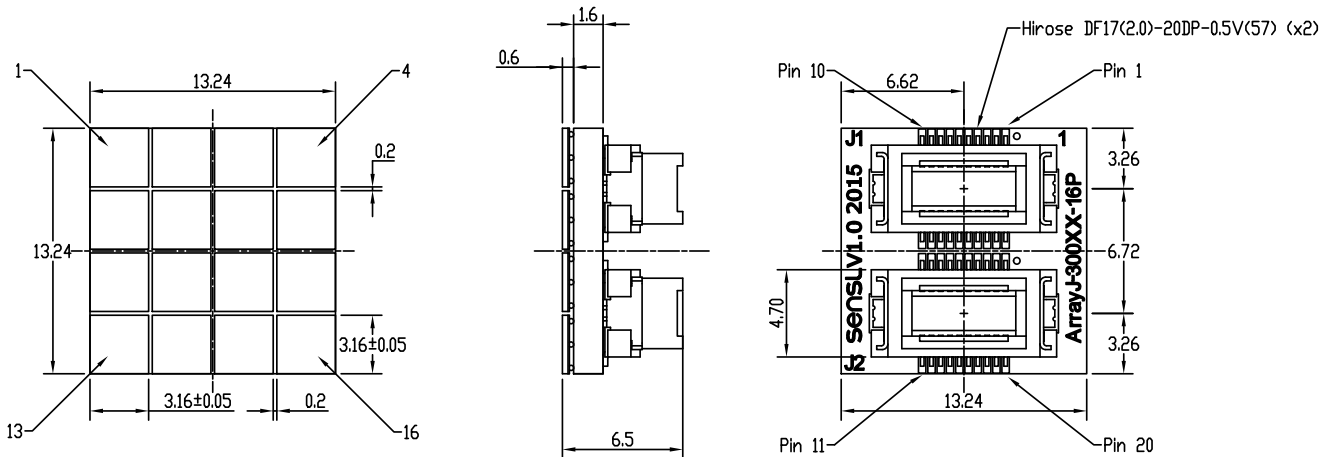

The complete ARRAYJ-300XX-16P-PCB CAD is available to [download](#).

ArrayJ Series

Connector Schematic for the ARRAYJ-300XX-16P-PCB

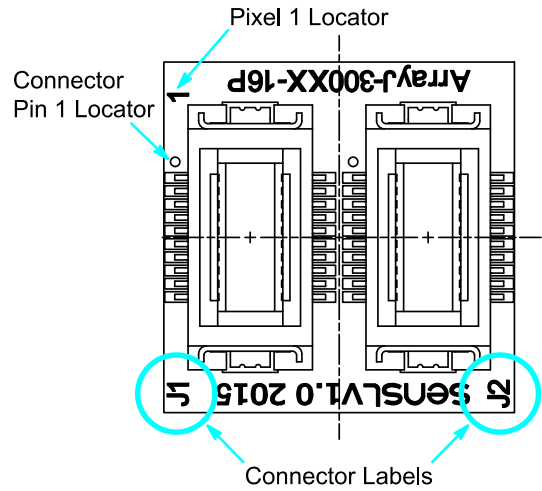
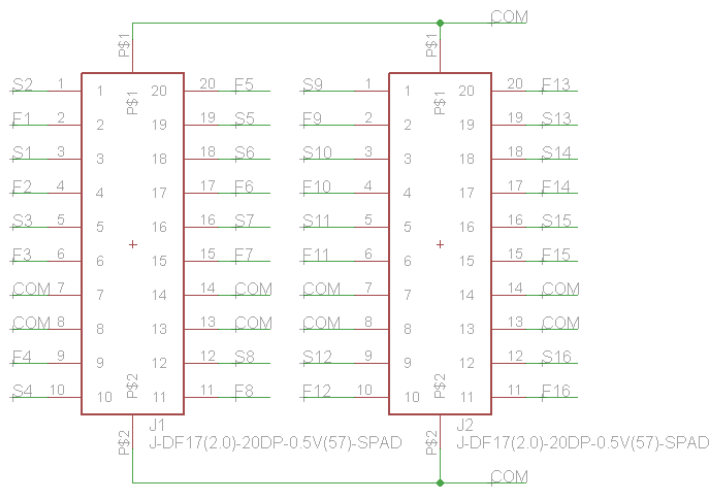

Figure 9. Connector pin-outs for the ARRAYJ-300XX-16P (left), and the location of the connectors (right).

Connector Schematic for the ARRAYJ-300XX-16P-PCB

The array pixel numbering is indicated on the drawing on the previous page.

J1				J2			
PIN	SIGNAL	PIN	SIGNAL	PIN	SIGNAL	PIN	SIGNAL
1	S2	2	F1	1	S9	2	F9
3	S1	4	F2	3	S10	4	F10
5	S3	6	F3	5	S11	6	F11
7	CM	8	CM	7	CM	8	CM
9	F4	10	S4	9	S12	10	F12
11	F8	12	S8	11	F16	12	S16
13	CM	14	CM	13	CM	14	CM
15	F7	16	S7	15	F15	16	S15
17	F6	18	S6	17	F14	18	S14
19	S5	20	F5	19	S13	20	F13

CM	Common I/O
Sn	Standard I/O of pixel n
Fn	Fast output of pixel n

ArrayJ Series

ARRAYJ-BOB3-16P (ARRAYJ-300XX-16P Breakout Board)

The ARRAYJ-BOB3-16P is an evaluation board allowing easy access to the signals from a **onsemi** ARRAYJ-300XX-16P, 3 mm 4 x 4 SiPM array.

The Breakout Board has two HIROSE 20-way connectors DF17(3.0)-20DS-0.5v(57). These connectors mate with the Samtec DF17(2.0)-20DP-0.5v(57) board-to-board connectors on the array. All signals on the array are

routed via the mating connectors to header pins. These pins are formed by two 20-way (10 x 2 row) 2.54 mm pitch headers.

Three SMA connectors and Balun transformers are provided with 4-pin headers to allow any signal to be connected directly to the SMA or via the transformer using jumper wires. Four 7 mm holes are aligned on a 25 mm grid to allow mounting of the board on an optical breadboard.

See Appendices A and B for examples of Breakout Board usage.

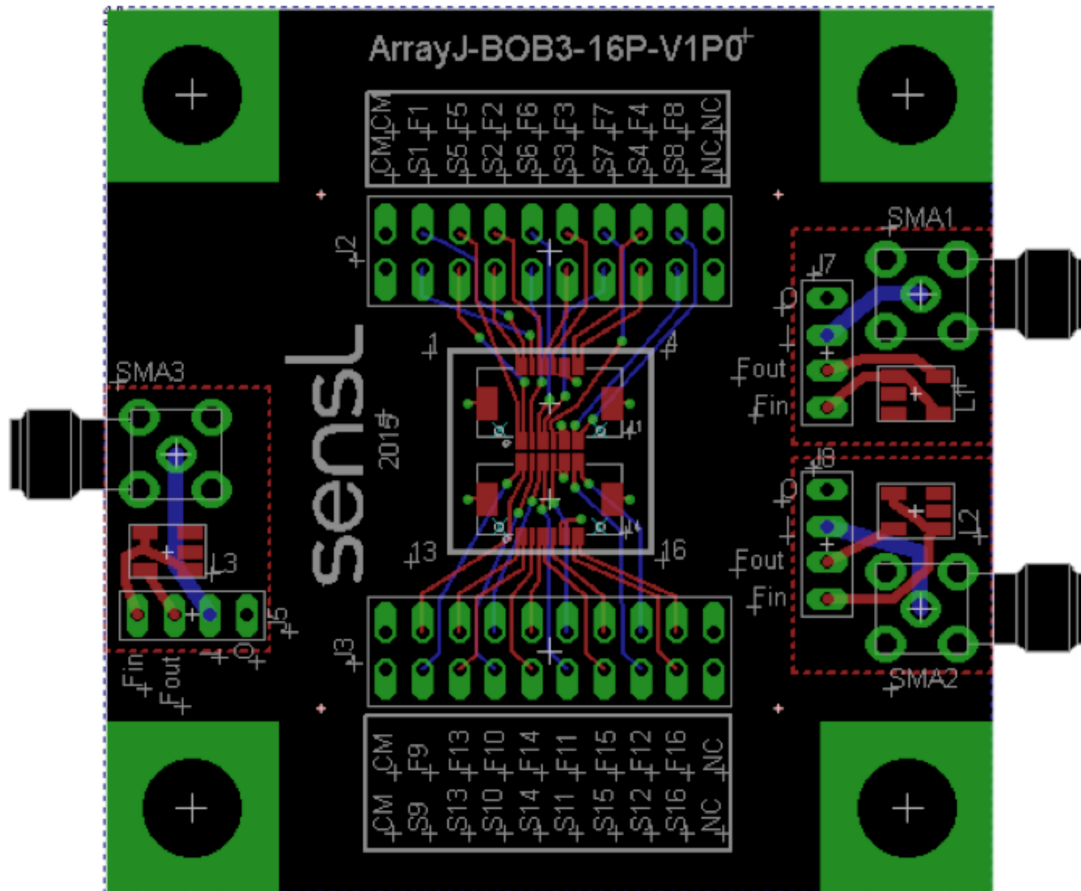

Figure 10. Layout of the ARRAYJ-BOB3-16P. Note that the array corner pixel numbers are shown on the silkscreen of the PCB to ensure correct orientation of the array.

ArrayJ Series

Header Signals for the ARRAYX-BOB3-16P

PIN		J2		J3	
1	2	CM	CM	CM	CM
3	4	S1	F1	S9	F9
5	6	S5	F5	S13	F13
7	8	S2	F2	S10	F10
9	10	S6	F6	S14	F14
11	12	S3	F3	S11	F11
13	14	S7	F17	S15	F15
15	16	S4	F4	S12	F12
17	18	S8	F6	S16	F16
19	20	NC	NC	NC	NC

NC	Not Connected
CM	Common I/O
Sn	Standard I/O of pixel n
Fn	Fast output of pixel n

ArrayJ Series

ARRAYJ-300XX-64P-PCB (8 X 8 Array of 3 mm Pixels)

Array Size	Sensor Type	Readout	Board Size	Pixel Pitch	No. Connections	No. Connectors
8 x 8	30035	Pixel	26.68 x 26.68 mm ²	3.36 mm	160	2 x 80-way
	30020					

The ARRAYJ-300XX-64P is comprised of 64 individual 3 mm J-Series sensors arranged in a 8 x 8 array. There are two types: The ARRAYJ-30035-64P has pixels which are formed of 35 um microcells, and the ARRAYJ-30020-64P has pixels that are formed of 20 um microcells.

The performance of the individual pixels and details of the bias to apply can be found in the [J-Series datasheet](#).

Connections to each sensor are provided by two Hirose 80-way connectors, type DF17(2.0)-80DP-0.5v(57). These connectors mate with the Hirose DF17(2.0)-80DS-0.5v(57) board-to-board connectors. The 64 SiPM sensors have all substrate connections (cathodes) connected together to form a common I/O. The 2 x 80-way connectors provide connections as follows:

- 64 x fast output
- 64 x standard I/O
- 32 x common I/O
- 4 x shield contacts to the Common

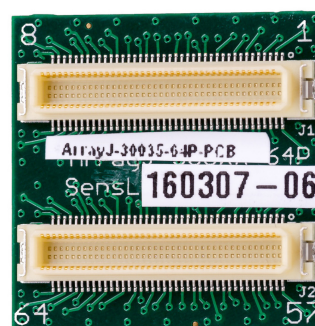
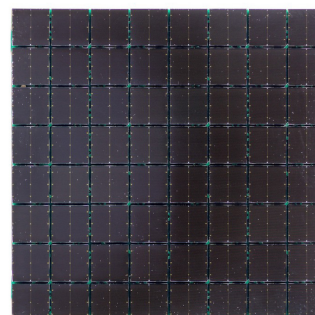

ARRAYJ-300XX-64P-PCB Board Drawing

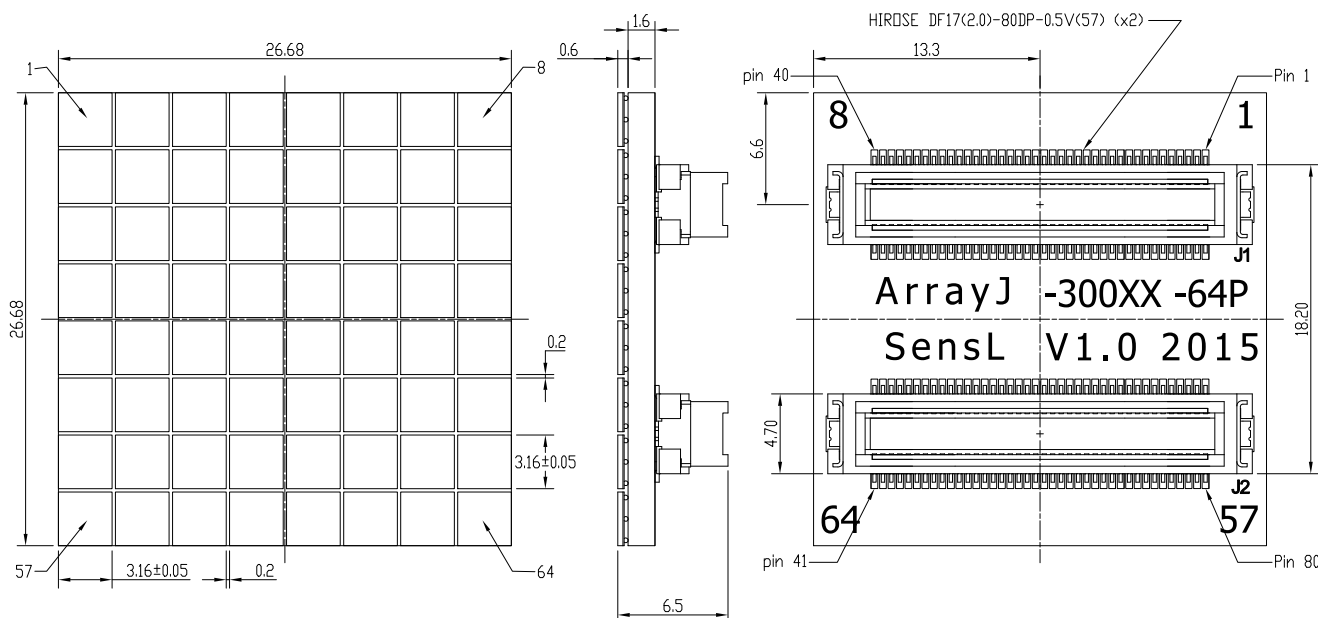

The complete ARRAYJ-300XX-64P-PCB CAD is available to [download](#).

ArrayJ Series

Connector Schematics for the ARRAYJ-300XX-64P

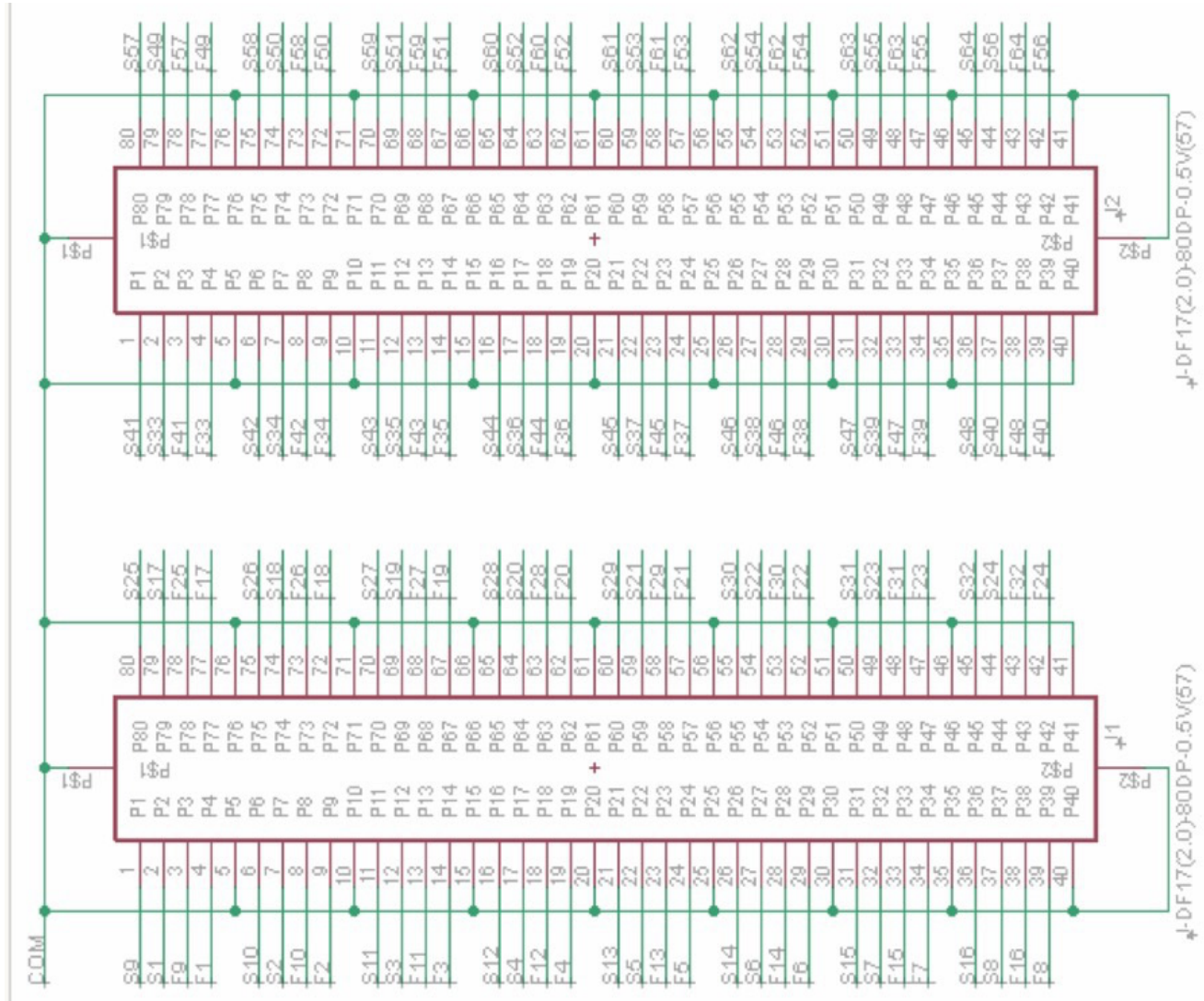

Figure 11. Schematic of the ARRAYJ-300XX-64P connectors.

ArrayJ Series

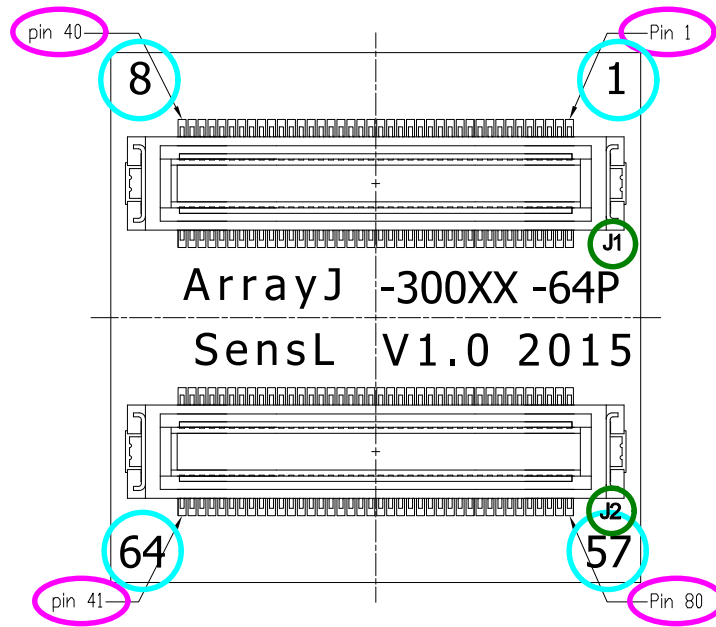

Figure 12. Highlighting the location of the connector, pin and array pixel numbering on the ARRAYJ-300XX-64P.

ArrayJ Series

Table 5. CONNECTOR PIN-OUTS FOR THE ARRAYJ-300XX-64P

J1				J2			
PIN	SIGNAL	PIN	SIGNAL	PIN	SIGNAL	PIN	SIGNAL
1	S9	2	S1	1	S41	2	S33
3	F9	4	F1	3	F41	4	F33
5	CM	6	S10	5	CM	6	S42
7	S2	8	F10	7	S34	8	F42
9	F2	10	CM	9	F34	10	CM
11	S11	12	S3	11	S43	12	S35
13	F11	14	F3	13	F43	14	F35
15	CM	16	S12	15	CM	16	S44
17	S4	18	F12	17	S36	18	F44
19	F4	20	CM	19	F36	20	CM
21	S13	22	S5	21	S45	22	S37
23	F13	24	F5	23	F45	24	F37
25	CM	26	S14	25	CM	26	S46
27	S6	28	F14	27	S38	28	F46
29	F6	30	CM	29	F38	30	CM
31	S15	32	S7	31	S47	32	S39
33	F15	34	F7	33	F47	34	F39
35	CM	36	S16	35	CM	36	S48
37	S8	38	F16	37	S40	38	F48
39	F8	40	CM	39	F40	40	CM
41	CM	42	F24	41	CM	42	F56
43	F32	44	S24	43	F64	44	S56
45	S32	46	CM	45	S64	46	CM
47	F23	48	F31	47	F55	48	F63
49	S23	50	S31	49	S55	50	S63
51	CM	52	F22	51	CM	52	F54
53	F30	54	S22	53	F62	54	S54
55	S30	56	CM	55	S62	56	CM
57	F21	58	F29	57	F53	58	F61
59	S21	60	S29	59	S53	60	S61
61	CM	62	F20	61	CM	62	F52
63	F28	64	S20	63	F60	64	S52
65	S28	66	CM	65	S60	66	CM
67	F19	68	F27	67	F51	68	F59
69	S19	70	S27	69	S51	70	S59
71	CM	72	F18	71	CM	72	F50
73	F26	74	S18	73	F58	74	S50
75	S26	76	CM	75	S58	76	CM
77	F17	78	F25	77	F49	78	F57
79	S17	80	S25	79	S49	80	S57

CM	Common I/O
Sn	Standard I/O of pixel n
Fn	Fast output of pixel n

ArrayJ Series

ARRAYJ-BOB3-64P (ARRAYJ-300XX-64P & ARRAYJ-40035-64P Breakout Board)

The ARRAYJ-BOB3-64P is an evaluation board allowing easy access to the signals from either a **onsemi** ARRAYJ-300XX-64P (3 mm pixel 8 x 8 SiPM array) or a **onsemi** ARRAYJ-40035-64P (4mm pixel, 8 x 8 SiPM array).

The Breakout Board has two Hirose 80-way connectors, type DF17(3.0)-80DS-0.5v(57). These connectors mate with the Hirose DF17(3.0)-80DP-0.5v(57) board-to-board connector on the array.

All signals on the array are routed via the mating connectors to header pins. These pins are formed by four 32-way (16 x 2 row) 2.54 mm pitch headers. Four additional header pin-pairs are provided for connection to the Common.

Three SMA connectors and Balun transformers are provided with 4-pin headers to allow any signal to be connected directly to the SMA or via the transformer using jumper wires. Four 7 mm holes are placed on a 25 mm grid to allow mounting of the board on an optical breadboard.

See Appendices A and B for examples of Breakout Board usage.

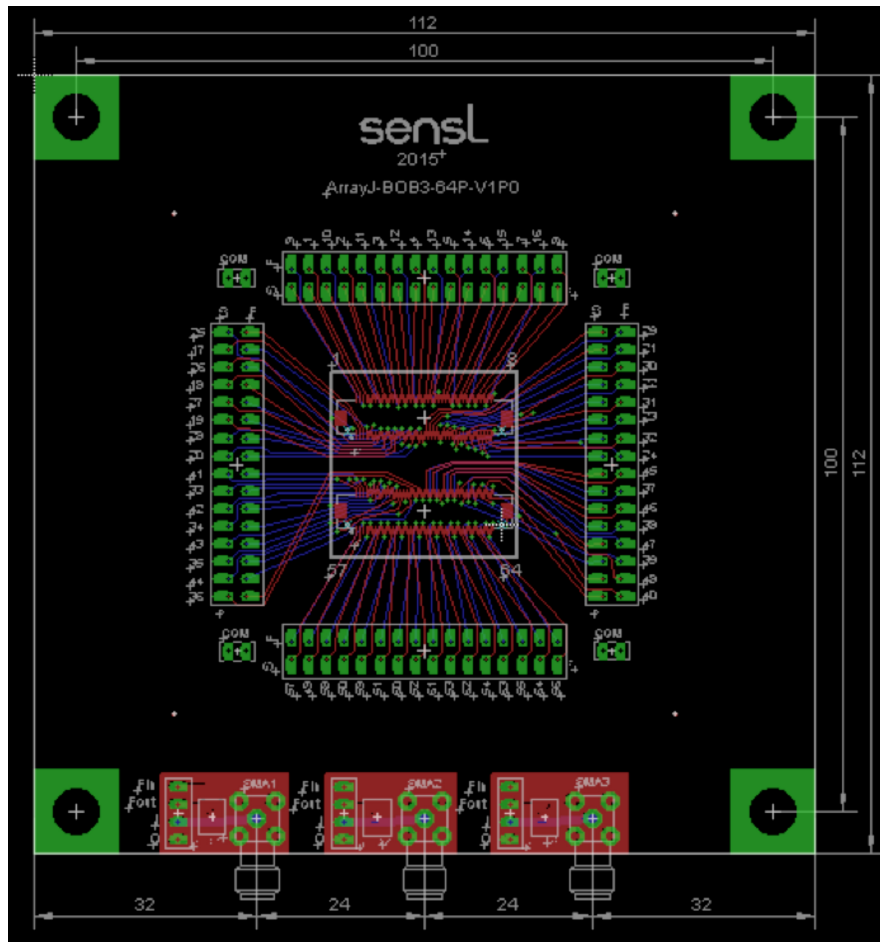

Figure 13. Layout of the ARRAYJ-BOB3-64P. Note that the array corner pixel numbers are shown on the silkscreen of the PCB to ensure correct orientation of the array.

ArrayJ Series

Header Signals for the ARRAYJ-BOB3-64P

PIN		J3		J4		J5		J6	
1	2	S9	F9	S57	F57	S25	F25	S29	F29
3	4	S1	F1	S49	F49	S17	F17	S21	F21
5	6	S10	F10	S58	F58	S26	F26	S30	F30
7	8	S2	F2	S50	F50	S18	F18	S22	F22
9	10	S11	F11	S59	F59	S27	F27	S31	F31
11	12	S3	F3	S51	F51	S19	F19	S23	F23
13	14	S12	F12	S60	F60	S28	F28	S32	F32
15	16	S4	F4	S52	F52	S20	F20	S24	F24
17	18	S13	F13	S61	F61	S41	F41	S45	F45
19	20	S5	F5	S53	F53	S33	F33	S37	F37
21	22	S14	F14	S62	F62	S42	F42	S46	F46
23	24	S6	F6	S54	F54	S34	F34	S38	F38
25	26	S15	F15	S63	F63	S43	F43	S47	F47
27	28	S7	F7	S55	F55	S35	F35	S39	F39
29	30	S16	F16	S64	F64	S44	F44	S48	F48
31	32	S8	F8	S56	F56	S36	F36	S40	F40

S _n	Standard I/O of pixel n
F _n	Fast output of pixel n

ArrayJ Series

Biasing and Readout from the Standard Breakout Boards

The purpose of the Breakout Boards is to allow easy access to either standard or fast I/O from individual pixels for testing purposes. It should be stressed that the breakout boards are for evaluation purposes only and do not allow for full readout of all pixels simultaneously.

The various Breakout Boards described in this document have features in common. All pixel fast and standard signals are brought out to headers. The header pins can be interfaced with the SMA connectors with the option of routing the signal via a balun transformer. The common I/O consists of all of the substrate connections summed together. It is not recommended to apply the bias to the common I/O.

The Breakout Boards are each shipped with 3 x shunt jumpers and 6 x 10 cm wire cables (3 x red, 3 x black) with crimp sockets at each end.

All header pins are suitable for use with wire wrapping in addition to the jumpers and crimp socket leads supplied.

The 'NC' signals are unconnected pins that can be used for prototyping.

SMA Connector

Each Breakout Board has three SMA connectors that can be used for supplying bias voltage and accessing signals. In

addition, each SMA has a balun transformer in close proximity for impedance matching of the fast signals, shown in Figure 13. To interface signals from the array to the SMA connectors, there is a 4-pin header, shown in Figure 12. The pins are labelled; **Fin**, **Fout**, **I** (Inner) and **O** (Outer).

- **Fin** provides the input to the balun transformer.
- **Fout** is the output of the balun transformer.
- **I** provides direct connection to the inner part of the SMA connector.
- **O** provides direct connection to the outer part of the SMA connector.

Balun Transformer

The Balun transformer (RFMD RFXF9503) allows impedance matching of the fast output signal to the readout electronics. For a customer considering their own design, the Balun is not required if the readout amplifiers are placed in close proximity to the sensor pixels of the array.

For optimized timing performance, the impedance matching and signal propagation from the SiPM sensor to the readout electronics must be carefully considered.

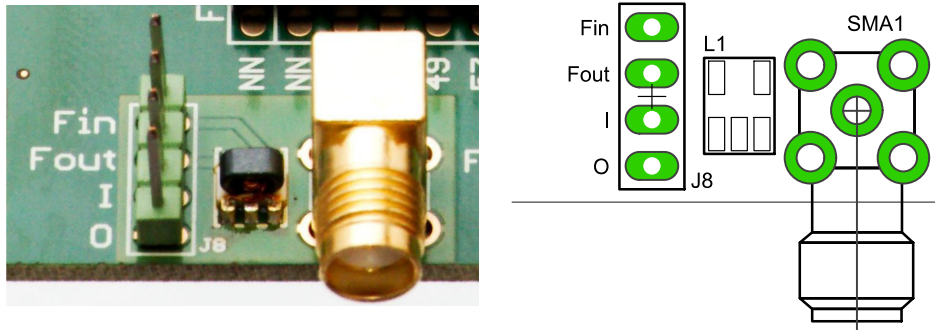
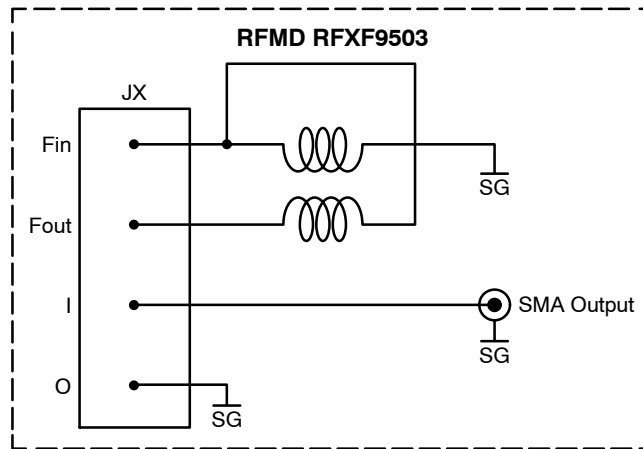

Figure 14. (right) photo and (left) schematic of the BOB SMA, balun transformer and 4-pin header arrangement.

ArrayJ Series



SG = Local signal ground

Each SMT/Balun/4 Way Header circuits has its own local signal ground

Figure 15. Schematic of the 4-pin header and balun transformer

EMI Considerations

It has been shown that the EMI (Electromagnetic Interference) can be picked up on the unshielded wires on the BOB. It is recommended that customers who experience excessive EMI seek to reduce the EMI in their lab, ideally at the EMI source. If this is not possible then improved shielding should be used. In all cases, testing of the SiPM sensor should be performed in total darkness.

For a system design, it is recommended that the customer consider shielding of all lines. The readout requirements for a SiPM are similar to that of a PMT and similar care should be taken with both sensor types. In comparison to an APD which has significantly lower gain than a SiPM, the SiPM will provide much improved resistance to EMI due to the higher gain of the SiPM sensor.

ArrayJ Series

APPENDIX A – EXAMPLE OF USING THE BREAKOUT BOARD TO READOUT FAST SIGNALS

The Figure 16 shows the ARRAYX–BOB6–64P set up for readout of fast signals from pixel 49

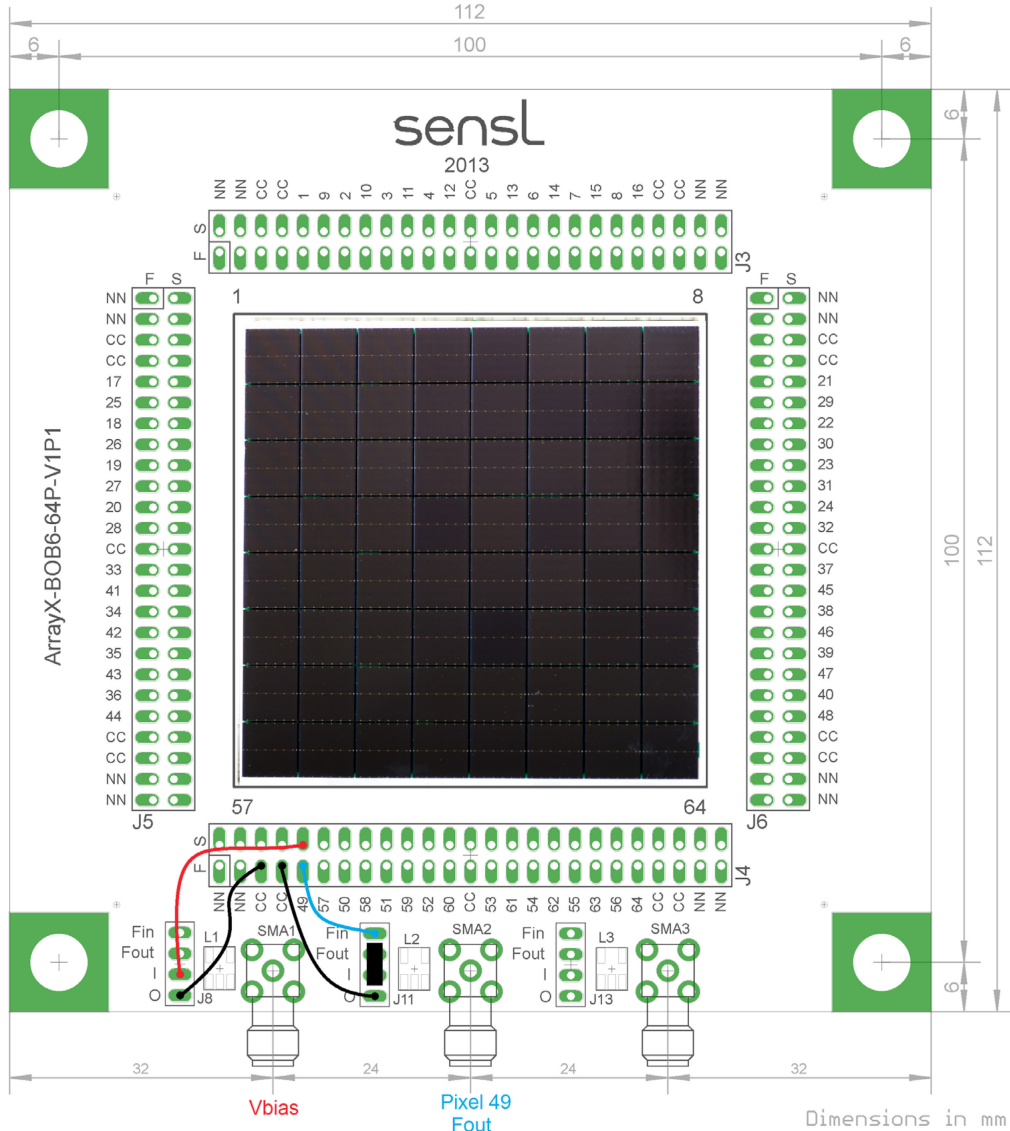

Figure 16. Example of an ARRAYJ–60035–64P connected to an ARRAYX–BOB6–64P for the readout of the fast signal from pixel 49.

Here, SMA1 is used for supplying Vbias and SMA2 for reading out the fast output from pixel 49. In this example an ARRAYJ–60035–64P is assumed and so the “S” (standard I/O) is the anode.

To bias the array, the inner (“I”) of SMA1 is connected to the S49 header pin. The cathode is common to all pixels and is connected via a “C” pin on the header to the outer (“O”) of SMA1. Refer to Figure 1 for signal connections for the J–Series array. Vbias is then applied to SMA1, which for an ArrayJ sensors has a negative polarity with respect to the common cathode.

To access the fast output from pixel 49, the F49 header pin is then connected to the Fin of SMA2. This is the input to the balun transformer for impedance matching of the fast signals. Fout (the output of the balun transformer) is then connected via a shunt jumper to the inner (“I”) of SMA2, with the outer (“O”) again connected to the common cathode (“C”). The schematic of the balun transformer is shown in Figure 15. The fast output from SMA2 will need amplification if the signal amplitudes are small.

ArrayJ Series

APPENDIX B – EXAMPLE OF USING THE BREAKOUT BOARD TO READOUT STANDARD SIGNALS

The Figure 17 shows the ARRAYX–BOB6–64P set up for readout of standard signals (anode–cathode) from pixel 49.

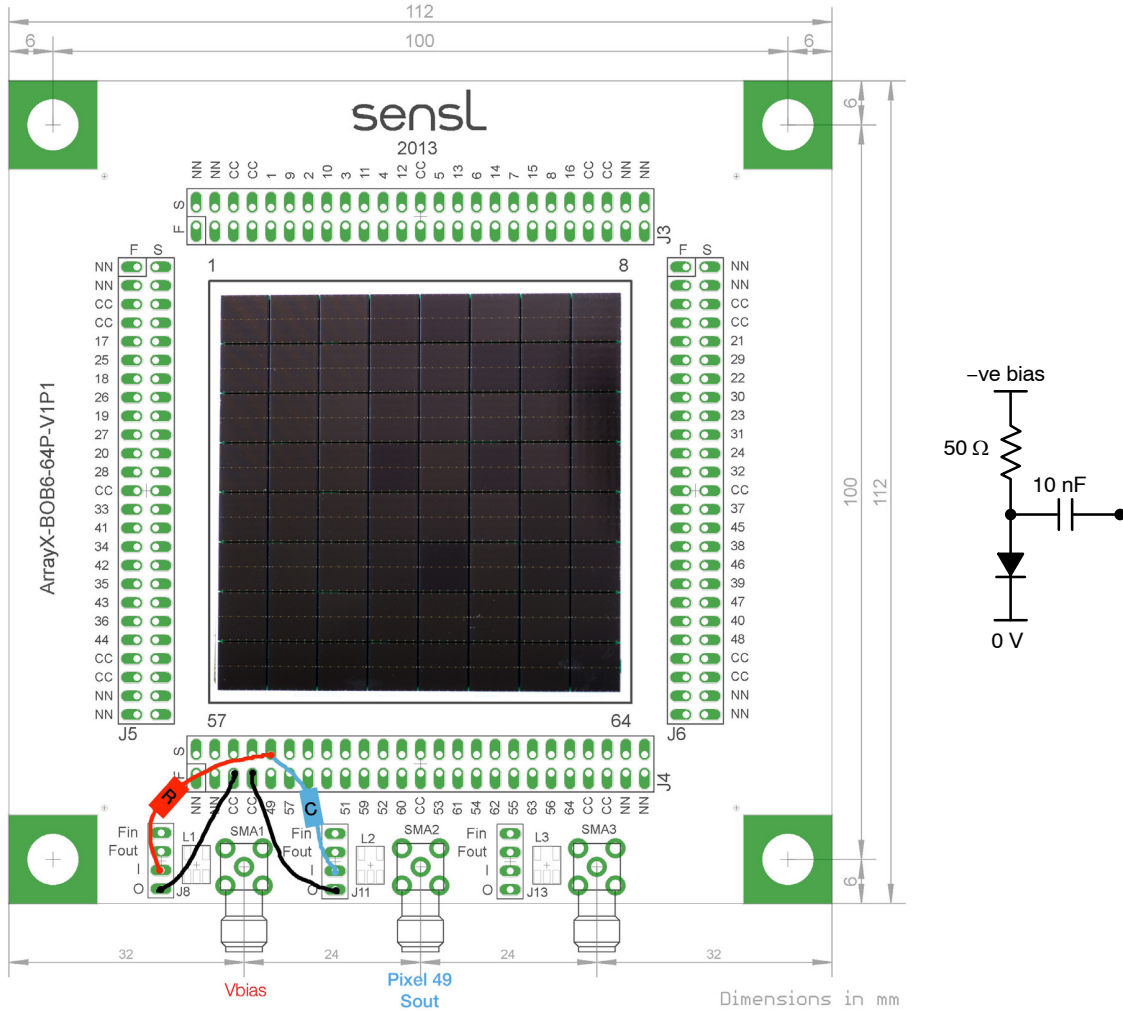

Figure 17. Example of an ARRAYJ–60035–64P connected to an ARRAYX–BOB6–64P for the readout of the fast signal from pixel 49.

Here, SMA 1 is used for supplying Vbias and SMA2 for reading out the standard output from pixel 49. In this example an ARRAYJ–60035–64P is assumed and so the “S” (standard I/O) is the anode.

To bias the array, the inner (“I”) of SMA1 is connected to the S49 (anode) header pin via a load resistor of 50 Ω. The cathode is common to all pixels and is connected via a “C” pin on the header to the outer (“O”) of SMA1. Vbias is then applied to SMA1, which for an ArrayJ sensors has a negative polarity with respect to the common cathode.

To access the standard output, the S49 header pin is then connected to the inner (“I”) of SMA2 via a decoupling capacitor of 10nF. The outer (“O”) of SMA 2 is again connected to the common cathode (“C”). The standard signal is then available from SMA2.

ArrayJ Series

APPENDIX C – EXAMPLE OF USING THE SUMMED BREAKOUT BOARD

The Figure 18 shows the ARRAYX–BOB6–64S set up for readout of all of the pixels summed together.

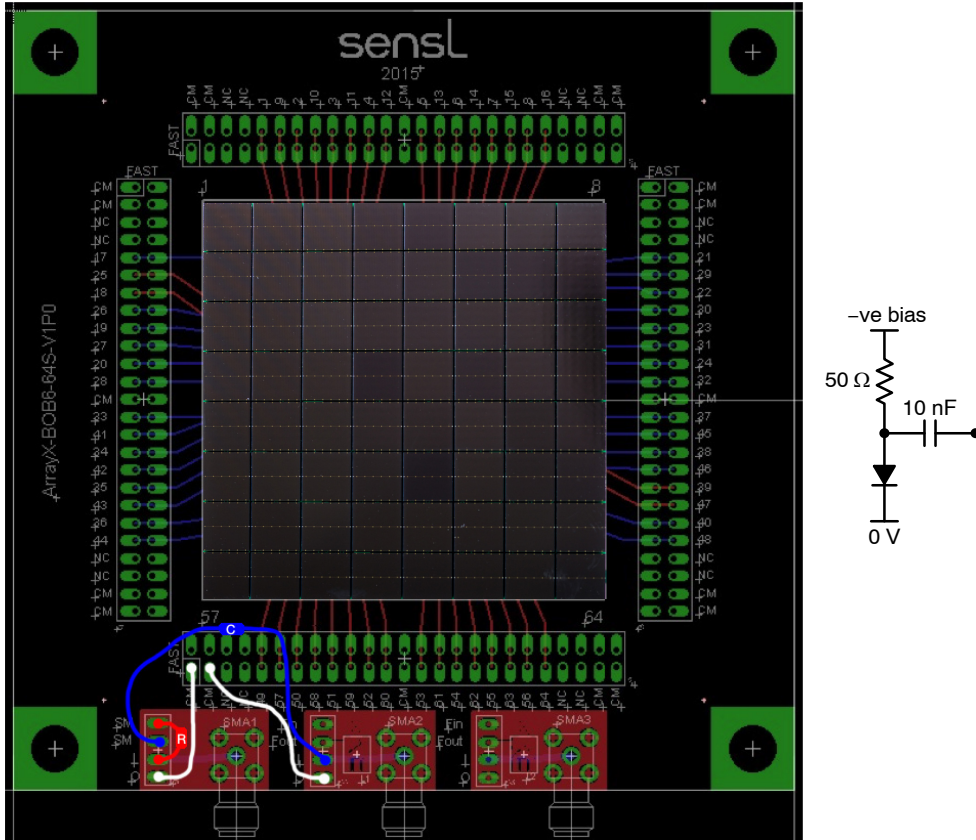

Figure 18. Example of an ARRAYJ–60035–64P connected to an ARRAYX–BOB6–64S for the summed readout of all of the pixels.

SMA 1 is used for supplying V_{bias} and SMA2 for reading out the summed standard output from all pixels in the ARRAYJ–60035–64P.

To bias the array, the inner (“I”) of SMA1 is connected to the SM (summed anode) pin on the same header, via a load resistor of $50\ \Omega$. The cathode is also common to all pixels and is connected via a “CM” pin to the outer (“O”) of SMA1.

V_{bias} is then applied to SMA1, which for an ArrayJ has a negative polarity with respect to the common.

To access the summed standard output, the second SM header pin is then connected to the inner (“I”) of SMA2 via a decoupling capacitor of 10 nF . The outer (“O”) of SMA2 is again connected to the common cathode (“CM”). The summed signal is then available from SMA2.

ArrayJ Series

ORDERING INFORMATION

Product Code	Microcell Size (Total Number per Pixel)	Array Size	I/O Interface
6 mm Sensor Arrays			
ARRAYJ-60035-4P-BGA	35 μ m (22,292 microcells)	2 x 2	BGA
ARRAYJ-60035-64P-PCB		8 x 8	Connector
4 mm Sensor Arrays			
ARRAYJ-40035-64P-PCB	35 μ m (9,260 microcells)	8 x 8	Connector
3 mm Sensor Arrays			
ARRAYJ-30035-16P-PCB	35 μ m (5,676 microcells)	4 x 4	Connector
ARRAYJ-30035-64P-PCB		8 x 8	Connector
ARRAYJ-30020-16P-PCB	20 μ m (14,850 microcells)	4 x 4	Connector
ARRAYJ-30020-64P-PCB		8 x 8	Connector
Optional Breakout Boards			
ARRAYX-BOB6-64P-GEVK	Breakout board for use with the ARRAYJ-60035-64P-PCB		
ARRAYJ-BOB3-16P-GEVK	Breakout board for use with the ARRAYJ-300XX-16P-PCB		
ARRAYJ-BOB3-64P-GEVK	Breakout board for use with the ARRAYJ-300XX-64P-PCB & ARRAYJ-40035-64P-PCB		
Optional Summed Breakout Boards			
ARRAYX-BOB6-64S-GEVK	Summed breakout board for use with the ARRAYJ-60035-64P-PCB		
Evaluation Board with ARRAYJ Permanently Attached			
ARRAYJ-60035-4P-PCB	Evaluation board with a permanently attached ARRAYJ-60035-4P-BGA and output pins		

SensL is a registered trademark of Semiconductor Components Industries, LLC dba "onsemi" or its affiliates and/or subsidiaries in the United States and/or other countries.

onsemi, **Onsemi**, and other names, marks, and brands are registered and/or common law trademarks of Semiconductor Components Industries, LLC dba "**onsemi**" or its affiliates and/or subsidiaries in the United States and/or other countries. **onsemi** owns the rights to a number of patents, trademarks, copyrights, trade secrets, and other intellectual property. A listing of **onsemi**'s product/patent coverage may be accessed at www.onsemi.com/site/pdf/Patent-Marking.pdf. **onsemi** reserves the right to make changes at any time to any products or information herein, without notice. The information herein is provided "as-is" and **onsemi** makes no warranty, representation or guarantee regarding the accuracy of the information, product features, availability, functionality, or suitability of its products for any particular purpose, nor does **onsemi** assume any liability arising out of the application or use of any product or circuit, and specifically disclaims any and all liability, including without limitation special, consequential or incidental damages. Buyer is responsible for its products and applications using **onsemi** products, including compliance with all laws, regulations and safety requirements or standards, regardless of any support or applications information provided by **onsemi**. "Typical" parameters which may be provided in **onsemi** data sheets and/or specifications can and do vary in different applications and actual performance may vary over time. All operating parameters, including "Typicals" must be validated for each customer application by customer's technical experts. **onsemi** does not convey any license under any of its intellectual property rights nor the rights of others. **onsemi** products are not designed, intended, or authorized for use as a critical component in life support systems or any FDA Class 3 medical devices or medical devices with a same or similar classification in a foreign jurisdiction or any devices intended for implantation in the human body. Should Buyer purchase or use **onsemi** products for any such unintended or unauthorized application, Buyer shall indemnify and hold **onsemi** and its officers, employees, subsidiaries, affiliates, and distributors harmless against all claims, costs, damages, and expenses, and reasonable attorney fees arising out of, directly or indirectly, any claim of personal injury or death associated with such unintended or unauthorized use, even if such claim alleges that **onsemi** was negligent regarding the design or manufacture of the part. **onsemi** is an Equal Opportunity/Affirmative Action Employer. This literature is subject to all applicable copyright laws and is not for resale in any manner.

PUBLICATION ORDERING INFORMATION

LITERATURE FULFILLMENT:

Email Requests to: orderlit@onsemi.com

onsemi Website: www.onsemi.com

TECHNICAL SUPPORT

North American Technical Support:

Voice Mail: 1 800-282-9855 Toll Free USA/Canada

Phone: 011 421 33 790 2910

Europe, Middle East and Africa Technical Support:

Phone: 00421 33 790 2910

For additional information, please contact your local Sales Representative

X-ON Electronics

Largest Supplier of Electrical and Electronic Components

Click to view similar products for [Photodiodes](#) category:

Click to view products by [ON Semiconductor](#) manufacturer:

Other Similar products are found below :

[LTR-526AD](#) [OED-SP-7L](#) [LTR-536AB](#) [LTR-743DBM1-TA](#) [67-21SYGC-S349-TR8](#) [SFH 2200 A01](#) [HFD3081-108-XBA](#) [BPW 34 S E9601](#)
[SFH 2713](#) [SFH 2703](#) [LTR-546AD](#) [BPV23FL](#) [BPW 34 FAS](#) [BPW 34 FS](#) [IG22X250S4I](#) [VTD205H](#) [VTD205KH](#) [VTP1220FBH](#) [VTP1232FH](#)
[VTP4085H](#) [SFH 2400](#) [OP913WSL](#) [OPF794](#) [PD70-01C/TR7](#) [LTR-536AD](#) [VTP8651H](#) [VTD206KH](#) [VTB1013H](#) [BPV23NF](#) [OP905](#) [LTR-](#)
[516AD](#) [BPW 34 FS-Z](#) [VTD34FH](#) [QSB34CGR](#) [SFH 2500 FA](#) [SFH 213 FA](#) [PD15-22C/TR8](#) [VEMD5510C](#) [SFH 2200](#) [VEMD5510CF](#)
[APS5130PD7C-P22](#) [SAH230M](#) [SAH230M2](#) [SAH500M2](#) [BP 104 FS](#) [BPV22F-AS12](#) [BPW 21](#) [BPW 34 SR-Z](#) [BPX 65](#) [HSDL-5400#011](#)