

BAT54CXV3

Dual Series Schottky Barrier Diodes

These Schottky barrier diodes are designed for high speed switching applications, circuit protection, and voltage clamping. Extremely low forward voltage reduces conduction loss. Miniature surface mount package is excellent for hand held and portable applications where space is limited.

Features

- Extremely Fast Switching Speed
- Low Forward Voltage – 0.35 V (Typ) @ $I_F = 10$ mA
- These Devices are Pb-Free, Halogen Free/BFR Free and are RoHS Compliant

MAXIMUM RATINGS ($T_J = 125^\circ\text{C}$ unless otherwise noted)

Rating	Symbol	Value	Unit
Reverse Voltage	V_R	30	V
Forward Power Dissipation @ $T_A = 25^\circ\text{C}$ Derate above 25°C	P_F	240 1.9	mW mW/ $^\circ\text{C}$
Forward Current (DC)	I_F	200 Max	mA
Non-Repetitive Peak Forward Current, $t_p < 10$ msec	I_{FSM}	600	mA
Repetitive Peak Forward Current Pulse Wave = 1 sec, Duty Cycle = 66%	I_{FRM}	300	mA
Junction Temperature	T_J	-55 to 125	$^\circ\text{C}$
Storage Temperature Range	T_{stg}	-55 to +150	$^\circ\text{C}$
Thermal Resistance, Junction-to-Ambient (Note 1)	$R_{\theta JA}$	525	$^\circ\text{C}/\text{W}$

Stresses exceeding those listed in the Maximum Ratings table may damage the device. If any of these limits are exceeded, device functionality should not be assumed, damage may occur and reliability may be affected.

1. FR-4 board with minimum mounting pad.



ON Semiconductor®

www.onsemi.com

30 VOLT DUAL COMMON CATHODE SCHOTTKY BARRIER DIODES



SC-89
CASE 463C
STYLE 3

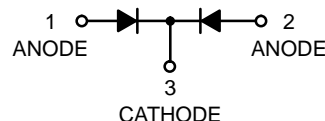

MARKING DIAGRAM

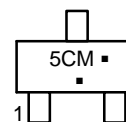

5C = Device Code
M = Date Code
▪ = Pb-Free Package

(Note: Microdot may be in either location)

ORDERING INFORMATION

Device	Package	Shipping†
BAT54CXV3T1G	SC-89 (Pb-Free)	3000 / Tape & Reel

†For information on tape and reel specifications, including part orientation and tape sizes, please refer to our Tape and Reel Packaging Specifications Brochure, BRD8011/D.

BAT54CXV3

ELECTRICAL CHARACTERISTICS ($T_A = 25^\circ\text{C}$ unless otherwise noted) (EACH DIODE)

Characteristic	Symbol	Min	Typ	Max	Unit
Reverse Breakdown Voltage ($I_R = 10 \mu\text{A}$)	$V_{(BR)R}$	30	–	–	V
Total Capacitance ($V_R = 1.0 \text{ V}$, $f = 1.0 \text{ MHz}$)	C_T	–	7.6	10	pF
Reverse Leakage ($V_R = 25 \text{ V}$)	I_R	–	0.5	2.0	μA_{dc}
Forward Voltage ($I_F = 0.1 \text{ mA}$) ($I_F = 1.0 \text{ mA}$) ($I_F = 10 \text{ mA}$) ($I_F = 30 \text{ mA}$) ($I_F = 100 \text{ mA}$)	V_F	– – – – –	0.22 0.29 0.35 0.41 0.52	0.24 0.32 0.40 0.50 0.80	V
Reverse Recovery Time ($I_F = I_R = 10 \text{ mA}_{dc}$, $I_{R(REC)} = 1.0 \text{ mA}_{dc}$, Figure 1)	t_{rr}	–	–	5.0	ns

Product parametric performance is indicated in the Electrical Characteristics for the listed test conditions, unless otherwise noted. Product performance may not be indicated by the Electrical Characteristics if operated under different conditions.

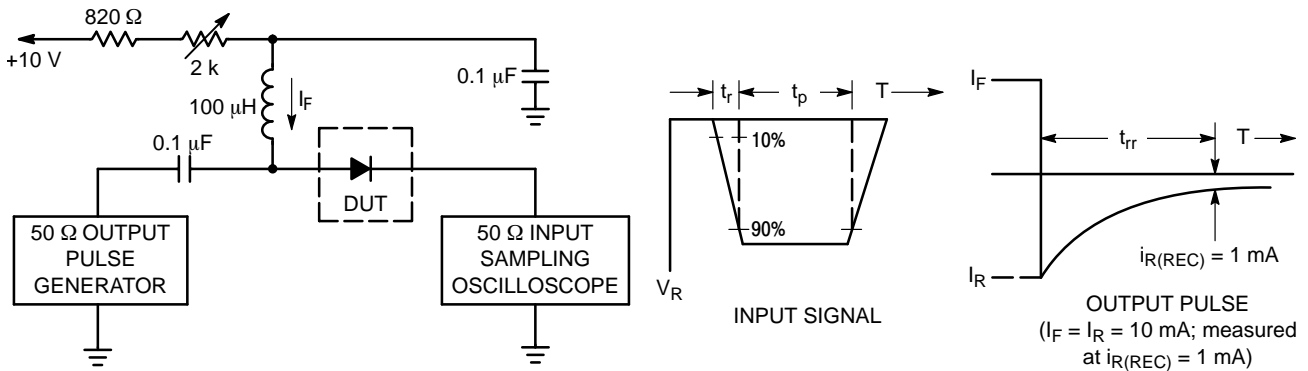

- Notes: 1. A 2.0 k Ω variable resistor adjusted for a Forward Current (I_F) of 10 mA.
2. Input pulse is adjusted so $I_{R(\text{peak})}$ is equal to 10 mA.
3. $t_p \gg t_{rr}$

Figure 1. Recovery Time Equivalent Test Circuit

BAT54CXV3

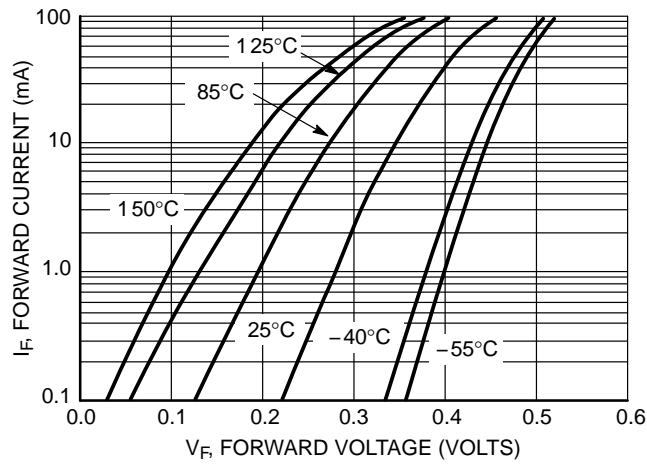

Figure 2. Forward Voltage

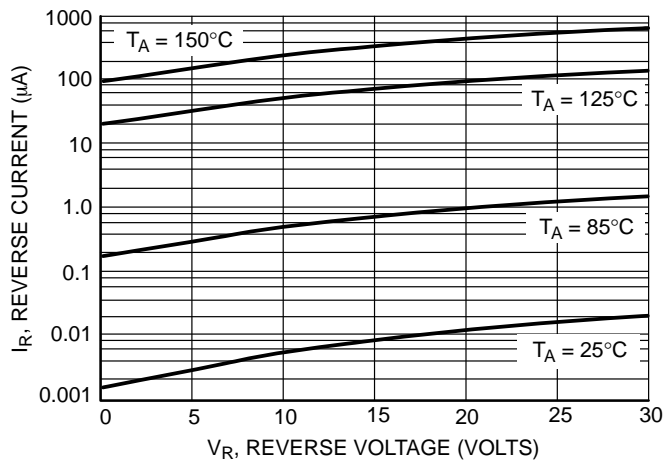

Figure 3. Leakage Current

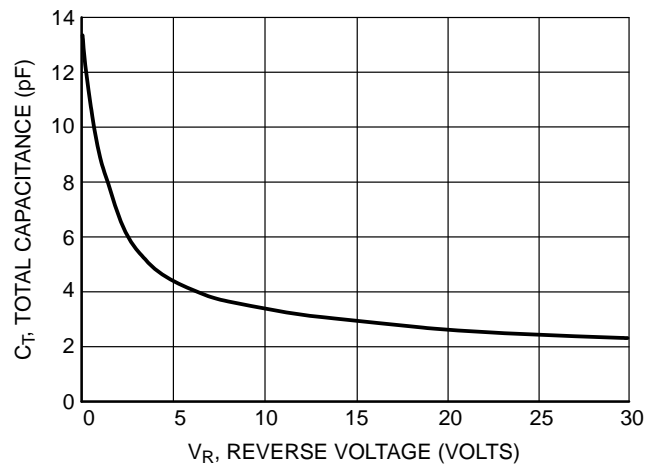

Figure 4. Total Capacitance

MECHANICAL CASE OUTLINE

PACKAGE DIMENSIONS

ON Semiconductor®



SCALE 4:1

SC-89, 3 LEAD CASE 463C-03 ISSUE C

DATE 31 JUL 2003

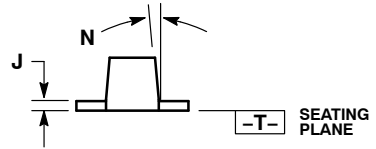
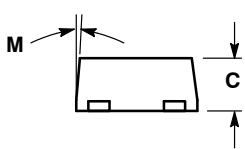
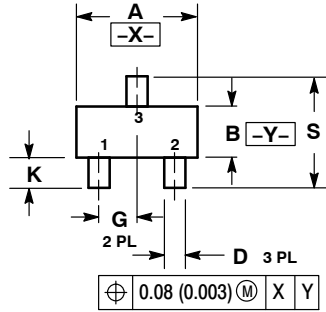

- STYLE 1:
PIN 1. BASE
2. EMITTER
3. COLLECTOR
- STYLE 2:
PIN 1. ANODE
2. N/C
3. CATHODE
- STYLE 3:
PIN 1. ANODE
2. ANODE
3. CATHODE
- STYLE 4:
PIN 1. CATHODE
2. CATHODE
3. ANODE

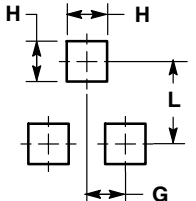

RECOMMENDED PATTERN OF SOLDER PADS

- NOTES:
- DIMENSIONING AND TOLERANCING PER ANSI Y14.5M, 1982.
 - CONTROLLING DIMENSION: MILLIMETERS
 - MAXIMUM LEAD THICKNESS INCLUDES LEAD FINISH THICKNESS. MINIMUM LEAD THICKNESS IS THE MINIMUM THICKNESS OF BASE MATERIAL.
 - 463C-01 OBSOLETE, NEW STANDARD 463C-02.

DIM	MILLIMETERS			INCHES		
	MIN	NOM	MAX	MIN	NOM	MAX
A	1.50	1.60	1.70	0.059	0.063	0.067
B	0.75	0.85	0.95	0.030	0.034	0.040
C	0.60	0.70	0.80	0.024	0.028	0.031
D	0.23	0.28	0.33	0.009	0.011	0.013
G	0.50 BSC			0.020 BSC		
H	0.53 REF			0.021 REF		
J	0.10	0.15	0.20	0.004	0.006	0.008
K	0.30	0.40	0.50	0.012	0.016	0.020
L	1.10 REF			0.043 REF		
M	---	---	10	---	---	10
N	---	---	10	---	---	10
S	1.50	1.60	1.70	0.059	0.063	0.067

GENERIC MARKING DIAGRAM*

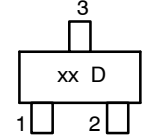

xx = Specific Device Code
D = Date Code

*This information is generic. Please refer to device data sheet for actual part marking.

DOCUMENT NUMBER:	98AON11472D	Electronic versions are uncontrolled except when accessed directly from the Document Repository. Printed versions are uncontrolled except when stamped "CONTROLLED COPY" in red.
DESCRIPTION:	SC-89, 3 LEAD	PAGE 1 OF 1

ON Semiconductor and are trademarks of Semiconductor Components Industries, LLC dba ON Semiconductor or its subsidiaries in the United States and/or other countries. ON Semiconductor reserves the right to make changes without further notice to any products herein. ON Semiconductor makes no warranty, representation or guarantee regarding the suitability of its products for any particular purpose, nor does ON Semiconductor assume any liability arising out of the application or use of any product or circuit, and specifically disclaims any and all liability, including without limitation special, consequential or incidental damages. ON Semiconductor does not convey any license under its patent rights nor the rights of others.

onsemi, **Onsemi**, and other names, marks, and brands are registered and/or common law trademarks of Semiconductor Components Industries, LLC dba "**onsemi**" or its affiliates and/or subsidiaries in the United States and/or other countries. **onsemi** owns the rights to a number of patents, trademarks, copyrights, trade secrets, and other intellectual property. A listing of **onsemi**'s product/patent coverage may be accessed at www.onsemi.com/site/pdf/Patent-Marking.pdf. **onsemi** reserves the right to make changes at any time to any products or information herein, without notice. The information herein is provided "as-is" and **onsemi** makes no warranty, representation or guarantee regarding the accuracy of the information, product features, availability, functionality, or suitability of its products for any particular purpose, nor does **onsemi** assume any liability arising out of the application or use of any product or circuit, and specifically disclaims any and all liability, including without limitation special, consequential or incidental damages. Buyer is responsible for its products and applications using **onsemi** products, including compliance with all laws, regulations and safety requirements or standards, regardless of any support or applications information provided by **onsemi**. "Typical" parameters which may be provided in **onsemi** data sheets and/or specifications can and do vary in different applications and actual performance may vary over time. All operating parameters, including "Typicals" must be validated for each customer application by customer's technical experts. **onsemi** does not convey any license under any of its intellectual property rights nor the rights of others. **onsemi** products are not designed, intended, or authorized for use as a critical component in life support systems or any FDA Class 3 medical devices or medical devices with a same or similar classification in a foreign jurisdiction or any devices intended for implantation in the human body. Should Buyer purchase or use **onsemi** products for any such unintended or unauthorized application, Buyer shall indemnify and hold **onsemi** and its officers, employees, subsidiaries, affiliates, and distributors harmless against all claims, costs, damages, and expenses, and reasonable attorney fees arising out of, directly or indirectly, any claim of personal injury or death associated with such unintended or unauthorized use, even if such claim alleges that **onsemi** was negligent regarding the design or manufacture of the part. **onsemi** is an Equal Opportunity/Affirmative Action Employer. This literature is subject to all applicable copyright laws and is not for resale in any manner.

PUBLICATION ORDERING INFORMATION

LITERATURE FULFILLMENT:

Email Requests to: orderlit@onsemi.com

onsemi Website: www.onsemi.com

TECHNICAL SUPPORT

North American Technical Support:

Voice Mail: 1 800-282-9855 Toll Free USA/Canada

Phone: 011 421 33 790 2910

Europe, Middle East and Africa Technical Support:

Phone: 00421 33 790 2910

For additional information, please contact your local Sales Representative

X-ON Electronics

Largest Supplier of Electrical and Electronic Components

Click to view similar products for [Schottky Diodes & Rectifiers](#) category:

Click to view products by [ON Semiconductor](#) manufacturer:

Other Similar products are found below :

[MA4E2039](#) [D1FH3-5063](#) [MBR10100CT-BP](#) [MBR1545CT](#) [MMBD301M3T5G](#) [RB160M-50TR](#) [RB551V-30](#) [BAS16E6433HTMA1](#) [BAT](#)
[54-02LRH E6327](#) [NSR05F40QNXT5G](#) [NTE555](#) [JANS1N6640](#) [SB07-03C-TB-H](#) [SB1003M3-TL-W](#) [SK310-T](#) [SK32A-LTP](#) [SK34B-TP](#)
[SS3003CH-TL-E](#) [GA01SHT18](#) [CRS10I30A\(TE85L,QM](#) [MA4E2501L-1290](#) [MBRB30H30CT-1G](#) [SB007-03C-TB-E](#) [SK32A-TP](#) [SK33B-TP](#)
[SK38B-TP](#) [NRVBM120LT1G](#) [NTE505](#) [NTSB30U100CT-1G](#) [SS15E-TP](#) [VS-6CWQ10FNHM3](#) [ACDBA1100LR-HF](#) [ACDBA1200-HF](#)
[ACDBA140-HF](#) [ACDBA2100-HF](#) [ACDBA3100-HF](#) [CDBQC0530L-HF](#) [ACDBA340-HF](#) [ACDBA260LR-HF](#) [ACDBA1100-HF](#) [SK310B-TP](#)
[MA4E2502L-1246](#) [MA4E2502H-1246](#) [NRVBM120ET1G](#) [NSR01L30MXT5G](#) [NTE573](#) [NTE6081](#) [SB560](#) [PMAD1108-LF](#) [SD103ATW-TP](#)