

BC846BPDW1, BC847BPDW1, BC848CPDW1 Series



ON Semiconductor®

www.onsemi.com

Dual General Purpose Transistors

NPN/PNP Duals (Complementary)

These transistors are designed for general purpose amplifier applications. They are housed in the SOT-363/SC-88 which is designed for low power surface mount applications.

Features

- S Prefix for Automotive and Other Applications Requiring Unique Site and Control Change Requirements; AEC-Q101 Qualified and PPAP Capable
- These Devices are Pb-Free, Halogen Free/BFR Free and are RoHS Compliant

MAXIMUM RATINGS – NPN

Rating	Symbol	Value	Unit
Collector-Emitter Voltage BC846, SBC846 BC847, SBC847 BC848	V_{CEO}	65 45 30	V
Collector-Base Voltage BC846, SBC846 BC847, SBC847 BC848	V_{CBO}	80 50 30	V
Emitter-Base Voltage	V_{EBO}	6.0	V
Collector Current – Continuous	I_C	100	mAdc
Collector Current – Peak	I_{CM}	200	mAdc

MAXIMUM RATINGS – PNP

Rating	Symbol	Value	Unit
Collector-Emitter Voltage BC846, SBC846 BC847, SBC847 BC848	V_{CEO}	-65 -45 -30	V
Collector-Base Voltage BC846, SBC846 BC847, SBC847 BC848	V_{CBO}	-80 -50 -30	V
Emitter-Base Voltage	V_{EBO}	-6.0	V
Collector Current – Continuous	I_C	-100	mAdc
Collector Current – Peak	I_{CM}	-200	mAdc

Stresses exceeding those listed in the Maximum Ratings table may damage the device. If any of these limits are exceeded, device functionality should not be assumed, damage may occur and reliability may be affected.



SOT-363
CASE 419B
STYLE 1

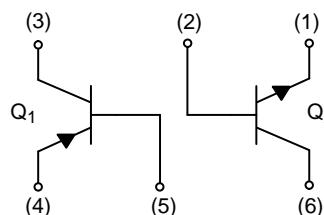

MARKING DIAGRAM

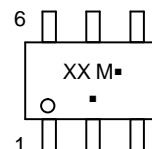

XX = Device Code
M = Date Code
▪ = Pb-Free Package

(Note: Microdot may be in either location)

ORDERING INFORMATION

Device	Mark	Package	Shipping†
BC846BPDW1T1G, SBC846BPDW1T1G	BB	SOT-363 (Pb-Free)	3,000 / Tape & Reel
SBC846BPDW1T2G	BB	SOT-363 (Pb-Free)	3,000 / Tape & Reel
BC847BPDW1T1G	BF	SOT-363 (Pb-Free)	3,000 / Tape & Reel
SBC847BPDW1T1G	BF	SOT-363 (Pb-Free)	3,000 / Tape & Reel
SBC847BPDW1T3G	BF	SOT-363 (Pb-Free)	10,000 / Tape & Reel
BC847BPDW1T2G	BF	SOT-363 (Pb-Free)	3,000 / Tape & Reel
BC848CPDW1T1G	BL	SOT-363 (Pb-Free)	3,000 / Tape & Reel

†For information on tape and reel specifications, including part orientation and tape sizes, please refer to our Tape and Reel Packaging Specification Brochure, BRD8011/D.

BC846BPDW1, BC847BPDW1, BC848CPDW1 Series

THERMAL CHARACTERISTICS

Characteristic	Symbol	Max	Unit
Total Device Dissipation Per Device FR-5 Board (Note 1) $T_A = 25^\circ\text{C}$ Derate above 25°C	P_D	380 250 3.0	mW mW/ $^\circ\text{C}$ mW/ $^\circ\text{C}$
Thermal Resistance, Junction-to-Ambient	$R_{\theta JA}$	328	$^\circ\text{C/W}$
Junction and Storage Temperature	T_J, T_{stg}	-55 to +150	$^\circ\text{C}$

1. FR-5 = 1.0 x 0.75 x 0.062 in.

ELECTRICAL CHARACTERISTICS (NPN) ($T_A = 25^\circ\text{C}$ unless otherwise noted)

Characteristic	Symbol	Min	Typ	Max	Unit
----------------	--------	-----	-----	-----	------

OFF CHARACTERISTICS

Collector-Emitter Breakdown Voltage ($I_C = 10\text{ mA}$) BC846, SBC846 Series BC847, SBC847 Series BC848 Series	$V_{(BR)CEO}$	65 45 30	- - -	- - -	V
Collector-Emitter Breakdown Voltage ($I_C = 10\ \mu\text{A}, V_{EB} = 0$) BC846, SBC846 Series BC847B, SBC847B Only BC848 Series	$V_{(BR)CES}$	80 50 30	- - -	- - -	V
Collector-Base Breakdown Voltage ($I_C = 10\ \mu\text{A}$) BC846, SBC846 Series BC847, SBC847 Series BC848 Series	$V_{(BR)CBO}$	80 50 30	- - -	- - -	V
Emitter-Base Breakdown Voltage ($I_E = 1.0\ \mu\text{A}$) BC846, SBC846 Series BC847, SBC847 Series BC848 Series	$V_{(BR)EBO}$	6.0 6.0 6.0	- - -	- - -	V
Collector Cutoff Current ($V_{CB} = 30\text{ V}$) ($V_{CB} = 30\text{ V}, T_A = 150^\circ\text{C}$)	I_{CBO}	- -	- -	15 5.0	nA μA

ON CHARACTERISTICS

DC Current Gain ($I_C = 10\ \mu\text{A}, V_{CE} = 5.0\text{ V}$) BC846B, SBC846B, BC847B, SBC847B BC848C ($I_C = 2.0\text{ mA}, V_{CE} = 5.0\text{ V}$) BC846B, SBC846B, BC847B, SBC847B BC848C	h_{FE}	- - 200 420	150 270 290 520	- - 475 800	-
Collector-Emitter Saturation Voltage ($I_C = 10\text{ mA}, I_B = 0.5\text{ mA}$) All devices except SBC847BPDW1T1G SBC847BPDW1T1G only ($I_C = 100\text{ mA}, I_B = 5.0\text{ mA}$) All devices ($I_C = 2\text{ mA}, I_B = 0.5\text{ mA}$) SBC847BPDW1T1G only	$V_{CE(sat)}$	- - - -	- - - 0.024	0.25 0.1 0.6 -	V
Base-Emitter Saturation Voltage ($I_C = 10\text{ mA}, I_B = 0.5\text{ mA}$) ($I_C = 100\text{ mA}, I_B = 5.0\text{ mA}$)	$V_{BE(sat)}$	- -	0.7 0.9	- -	V
Base-Emitter Voltage ($I_C = 2.0\text{ mA}, V_{CE} = 5.0\text{ V}$) ($I_C = 10\text{ mA}, V_{CE} = 5.0\text{ V}$)	$V_{BE(on)}$	580 -	660 -	700 770	mV

SMALL-SIGNAL CHARACTERISTICS

Current-Gain - Bandwidth Product ($I_C = 10\text{ mA}, V_{CE} = 5.0\text{ Vdc}, f = 100\text{ MHz}$)	f_T	100	-	-	MHz
Output Capacitance ($V_{CB} = 10\text{ V}, f = 1.0\text{ MHz}$)	C_{obo}	-	-	4.5	pF
Noise Figure ($I_C = 0.2\text{ mA}, V_{CE} = 5.0\text{ Vdc}, R_S = 2.0\text{ k}\Omega, f = 1.0\text{ kHz}, BW = 200\text{ Hz}$)	NF	-	-	10	dB

BC846BPDW1, BC847BPDW1, BC848CPDW1 Series

ELECTRICAL CHARACTERISTICS (PNP) ($T_A = 25^\circ\text{C}$ unless otherwise noted)

Characteristic	Symbol	Min	Typ	Max	Unit
OFF CHARACTERISTICS					
Collector–Emitter Breakdown Voltage ($I_C = -10\text{ mA}$) BC846, SBC846 Series BC847, SBC847 Series BC848 Series	$V_{(BR)CEO}$	-65 -45 -30	-	-	V
Collector–Emitter Breakdown Voltage ($I_C = -10\ \mu\text{A}$, $V_{EB} = 0$) BC846, SBC846 Series BC847, SBC847 Series BC848 Series	$V_{(BR)CES}$	-80 -50 -30	-	-	V
Collector–Base Breakdown Voltage ($I_C = -10\ \mu\text{A}$) BC846, SBC846 Series BC847, SBC847 Series BC848 Series	$V_{(BR)CBO}$	-80 -50 -30	-	-	V
Emitter–Base Breakdown Voltage ($I_E = -1.0\ \mu\text{A}$) BC846, SBC846 Series BC847, SBC847 Series BC848 Series	$V_{(BR)EBO}$	-6.0 -6.0 -6.0	-	-	V
Collector Cutoff Current ($V_{CB} = -30\text{ V}$) ($V_{CB} = -30\text{ V}$, $T_A = 150^\circ\text{C}$)	I_{CBO}	- -	- -	-15 -4.0	nA μA
ON CHARACTERISTICS					
DC Current Gain ($I_C = -10\ \mu\text{A}$, $V_{CE} = -5.0\text{ V}$) BC846B, SBC846B, BC847B, SBC847B BC848C ($I_C = -2.0\text{ mA}$, $V_{CE} = -5.0\text{ V}$) BC846B, SBC846B, BC847B, SBC847B BC848C	h_{FE}	- - 200 420	150 270 290 520	- - 475 800	-
Collector–Emitter Saturation Voltage ($I_C = -10\text{ mA}$, $I_B = -0.5\text{ mA}$) All devices except SBC847BPDW1T1G SBC847BPDW1T1G only ($I_C = -100\text{ mA}$, $I_B = -5.0\text{ mA}$) All devices ($I_C = -2\text{ mA}$, $I_B = -0.5\text{ mA}$) SBC847BPDW1T1G only	$V_{CE(sat)}$	- - - -	- - - -0.024	-0.3 -0.1 -0.65 -	V
Base–Emitter Saturation Voltage ($I_C = -10\text{ mA}$, $I_B = -0.5\text{ mA}$) ($I_C = -100\text{ mA}$, $I_B = -5.0\text{ mA}$)	$V_{BE(sat)}$	- -	-0.7 -0.9	- -	V
Base–Emitter On Voltage ($I_C = -2.0\text{ mA}$, $V_{CE} = -5.0\text{ V}$) ($I_C = -10\text{ mA}$, $V_{CE} = -5.0\text{ V}$)	$V_{BE(on)}$	-0.6 -	- -	-0.75 -0.82	V
SMALL–SIGNAL CHARACTERISTICS					
Current–Gain – Bandwidth Product ($I_C = -10\text{ mA}$, $V_{CE} = -5.0\text{ Vdc}$, $f = 100\text{ MHz}$)	f_T	100	-	-	MHz
Output Capacitance ($V_{CB} = -10\text{ V}$, $f = 1.0\text{ MHz}$)	C_{ob}	-	-	4.5	pF
Noise Figure ($I_C = -0.2\text{ mA}$, $V_{CE} = -5.0\text{ Vdc}$, $R_S = 2.0\text{ k}\Omega$, $f = 1.0\text{ kHz}$, $BW = 200\text{ Hz}$)	NF	-	-	10	dB

BC846BPDW1, BC847BPDW1, BC848CPDW1 Series

TYPICAL NPN CHARACTERISTICS – BC846/SBC846

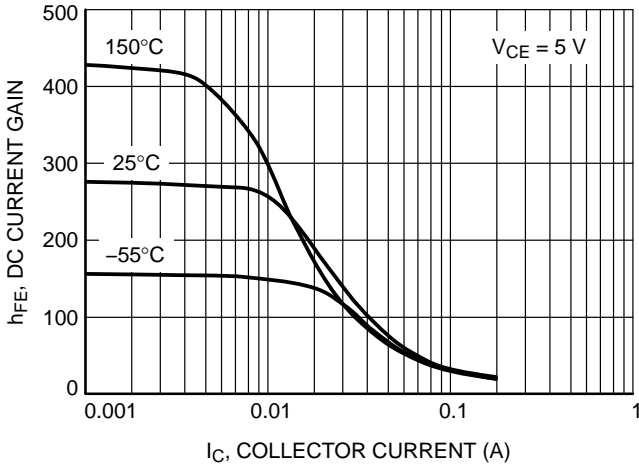

Figure 1. DC Current Gain vs. Collector Current

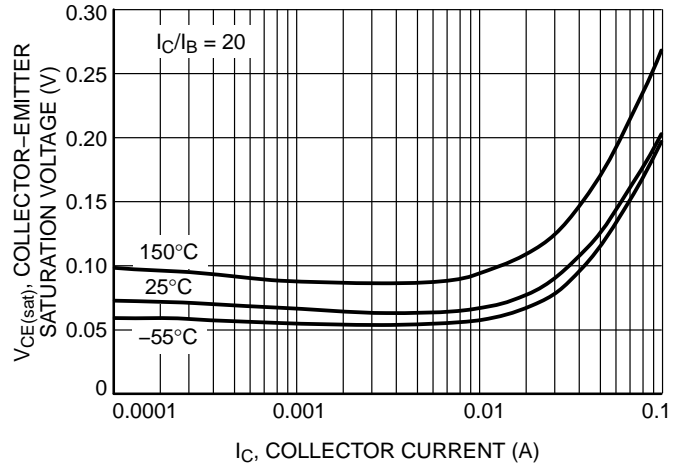

Figure 2. Collector Emitter Saturation Voltage vs. Collector Current

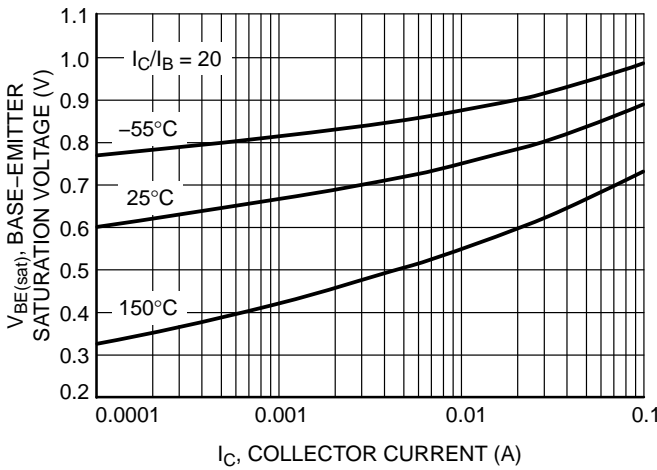

Figure 3. Base Emitter Saturation Voltage vs. Collector Current

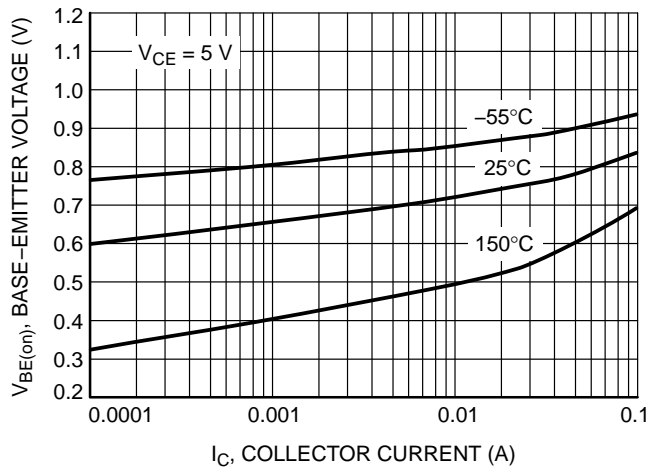

Figure 4. Base Emitter Voltage vs. Collector Current

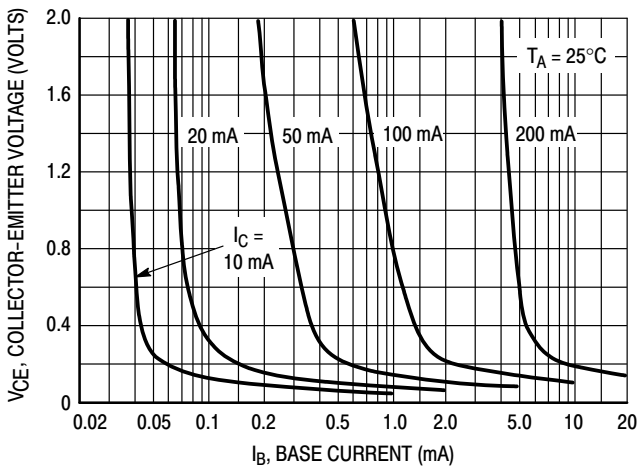

Figure 5. Collector Saturation Region

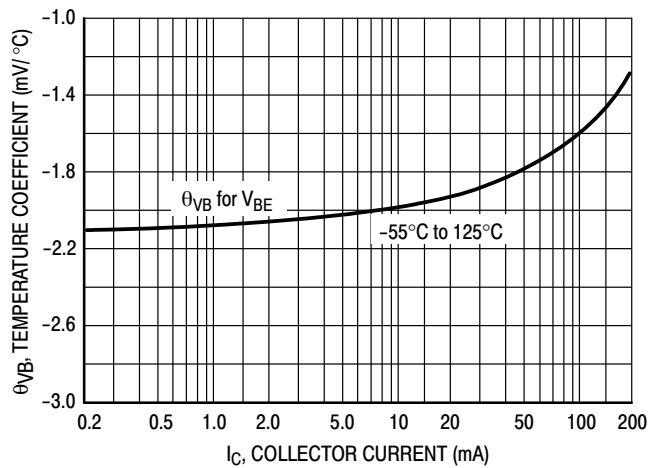

Figure 6. Base-Emitter Temperature Coefficient

BC846BPDW1, BC847BPDW1, BC848CPDW1 Series

TYPICAL NPN CHARACTERISTICS – BC846/SBC846

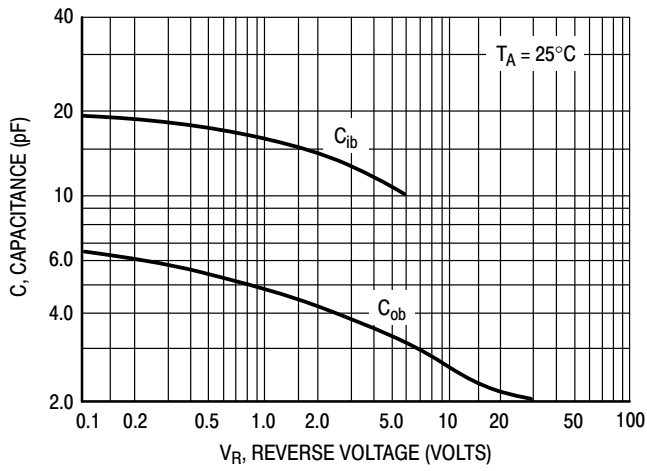

Figure 7. Capacitance

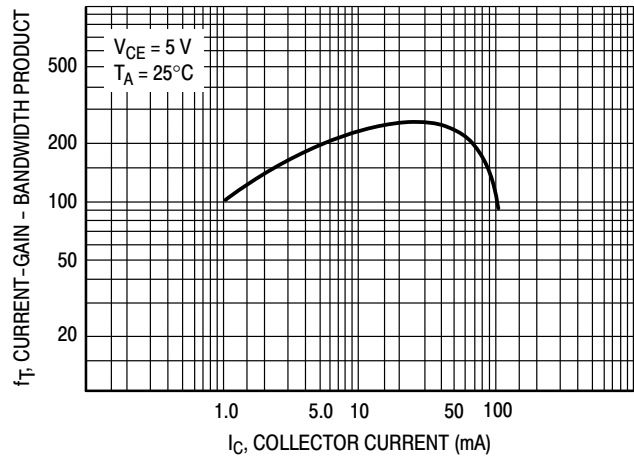

Figure 8. Current-Gain - Bandwidth Product

BC846BPDW1, BC847BPDW1, BC848CPDW1 Series

TYPICAL PNP CHARACTERISTICS — BC846/SBC846

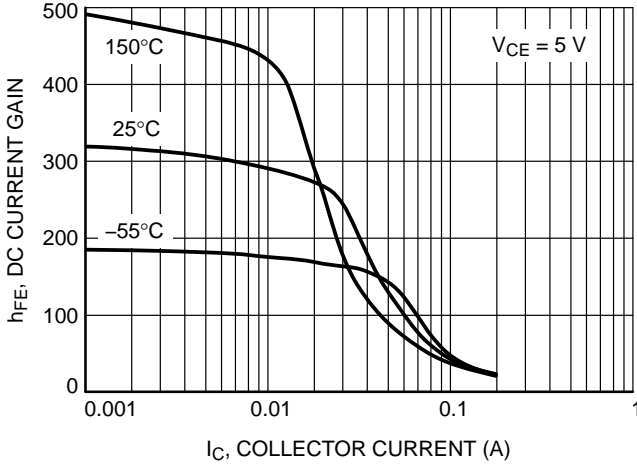

Figure 9. DC Current Gain vs. Collector Current

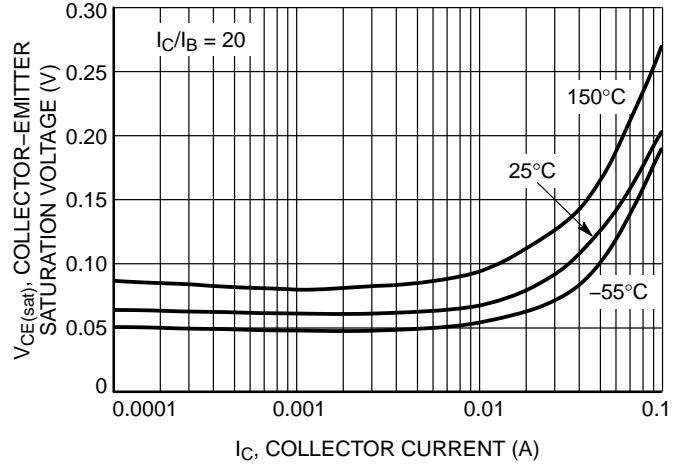

Figure 10. Collector Emitter Saturation Voltage vs. Collector Current

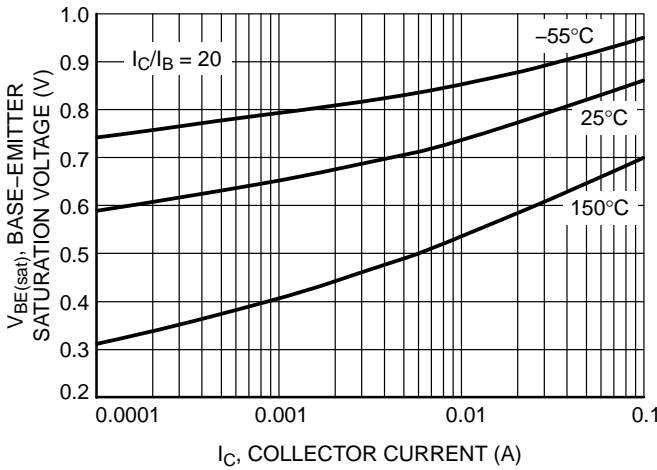

Figure 11. Base Emitter Saturation Voltage vs. Collector Current

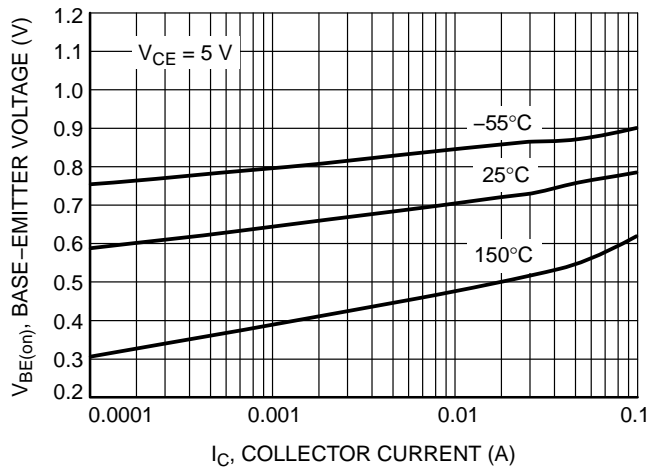

Figure 12. Base Emitter Voltage vs. Collector Current

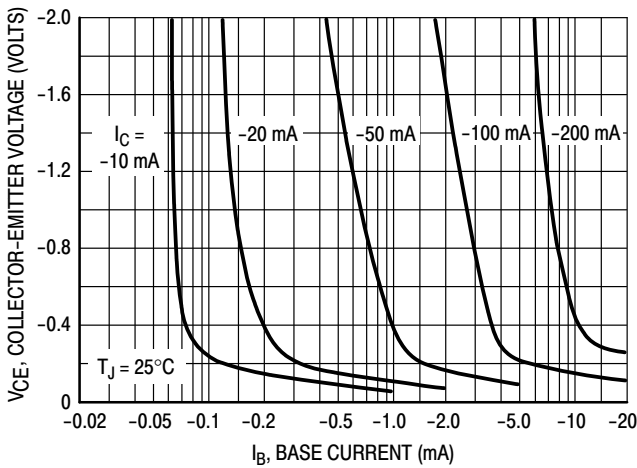

Figure 13. Collector Saturation Region

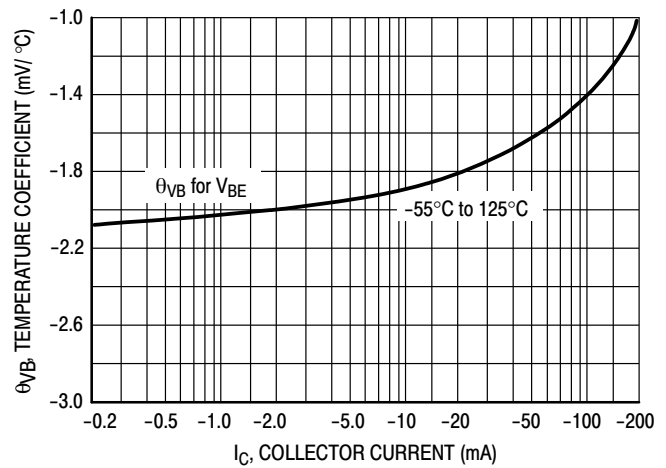

Figure 14. Base-Emitter Temperature Coefficient

BC846BPDW1, BC847BPDW1, BC848CPDW1 Series

TYPICAL PNP CHARACTERISTICS — BC846/SBC846

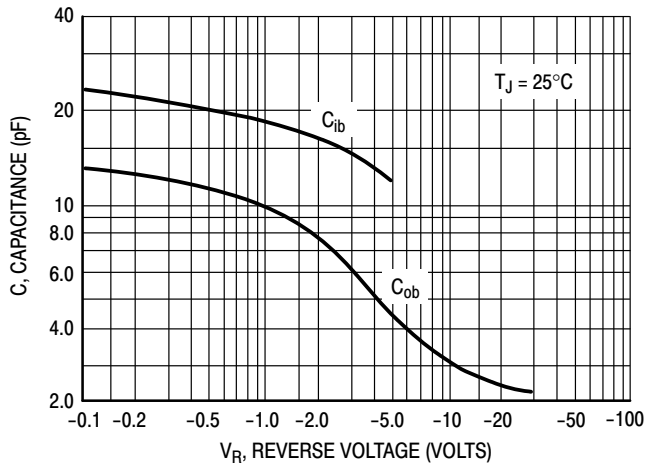

Figure 15. Capacitance

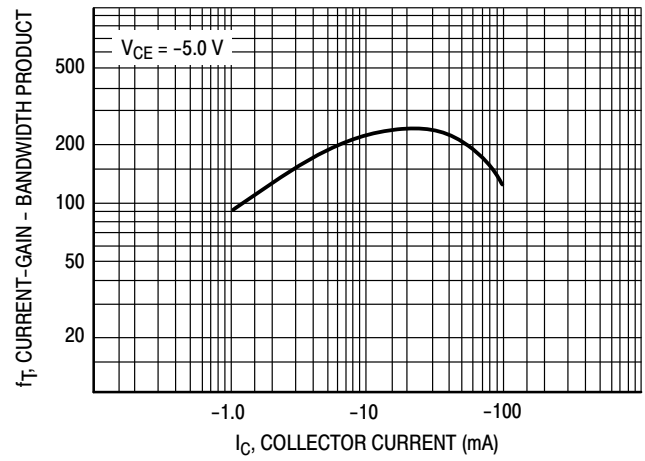

Figure 16. Current-Gain - Bandwidth Product

BC846BPDW1, BC847BPDW1, BC848CPDW1 Series

TYPICAL NPN CHARACTERISTICS – BC847/SBC847 SERIES

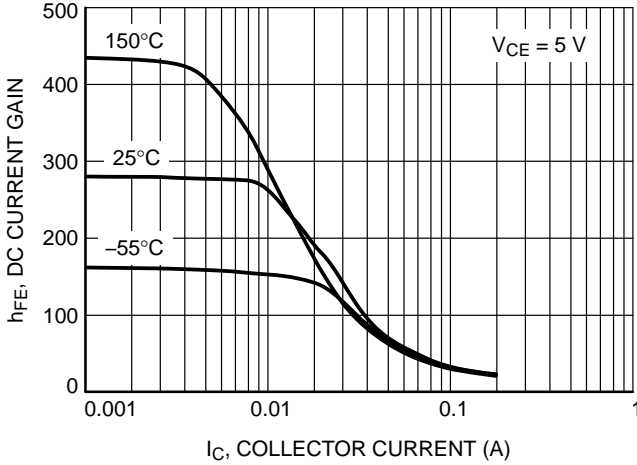

Figure 17. DC Current Gain vs. Collector Current

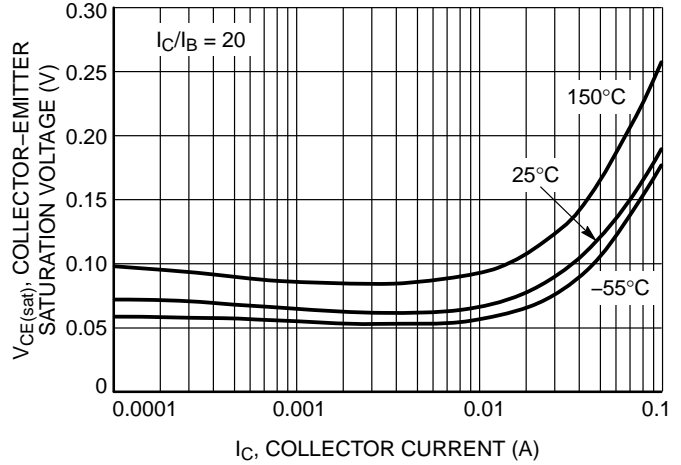

Figure 18. Collector Emitter Saturation Voltage vs. Collector Current

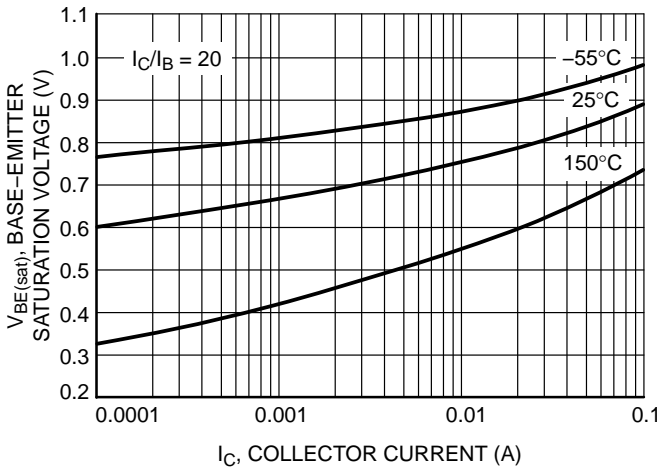

Figure 19. Base Emitter Saturation Voltage vs. Collector Current

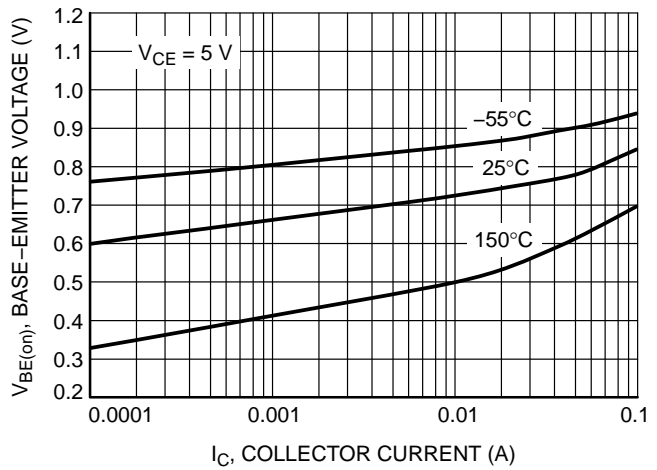

Figure 20. Base Emitter Voltage vs. Collector Current

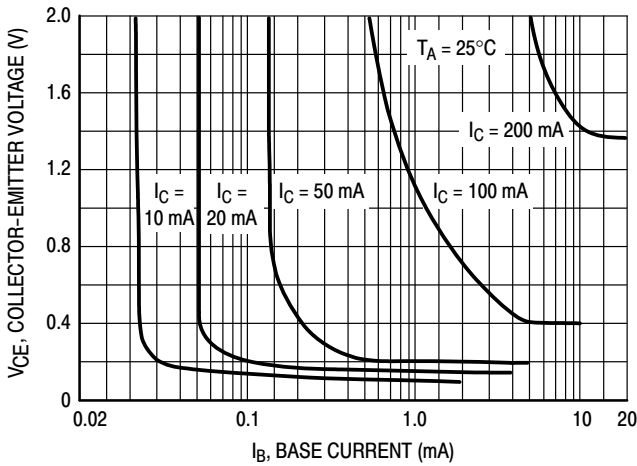

Figure 21. Collector Saturation Region

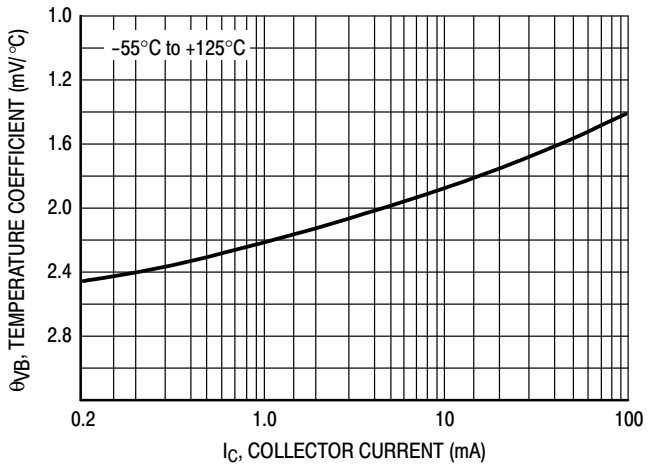

Figure 22. Base-Emitter Temperature Coefficient

BC846BPDW1, BC847BPDW1, BC848CPDW1 Series

TYPICAL NPN CHARACTERISTICS – BC847/SBC847 SERIES

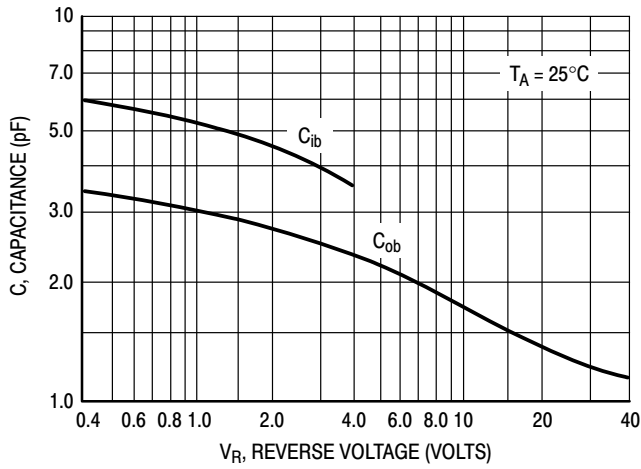

Figure 23. Capacitances

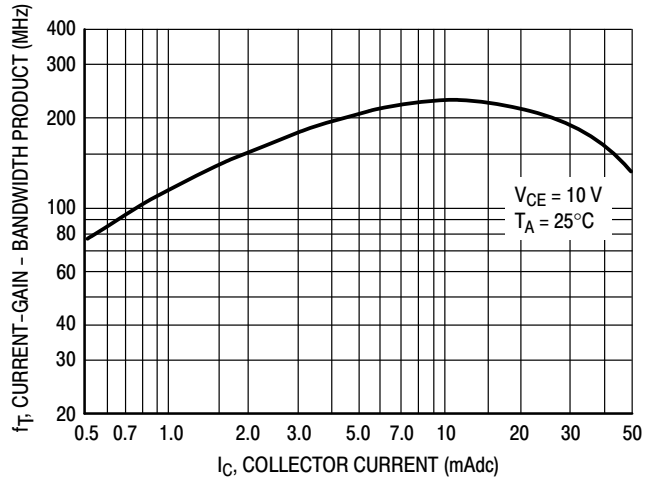

Figure 24. Current-Gain - Bandwidth Product

BC846BPDW1, BC847BPDW1, BC848CPDW1 Series

TYPICAL PNP CHARACTERISTICS – BC847/SBC847 SERIES

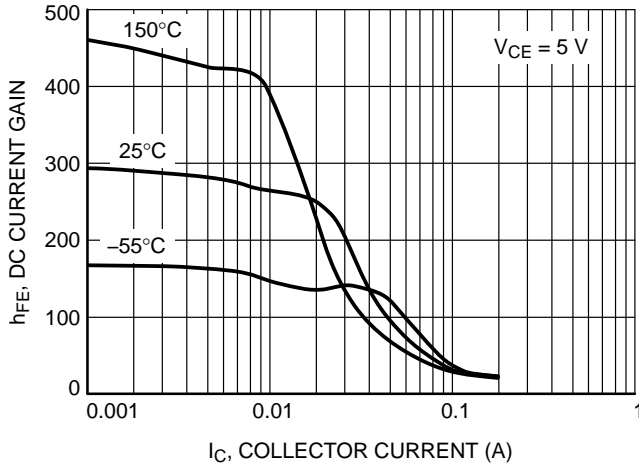

Figure 25. DC Current Gain vs. Collector Current

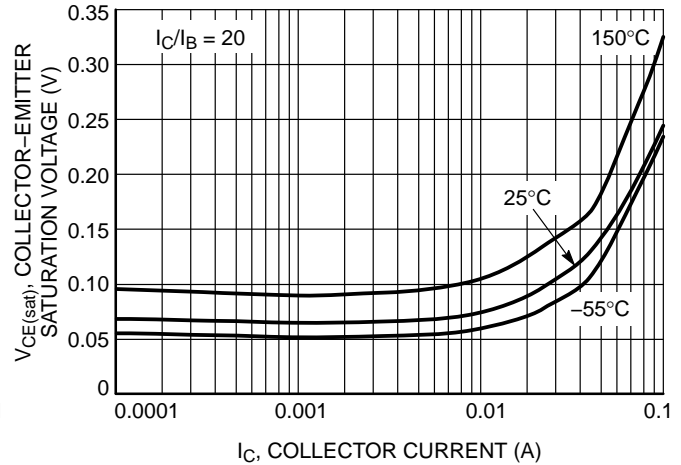

Figure 26. Collector Emitter Saturation Voltage vs. Collector Current

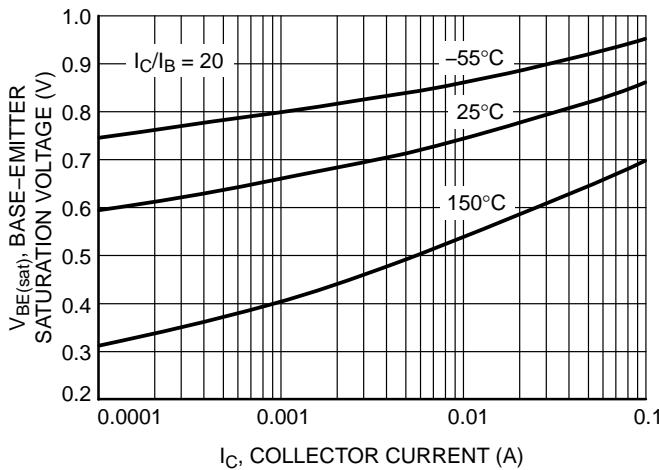

Figure 27. Base Emitter Saturation Voltage vs. Collector Current

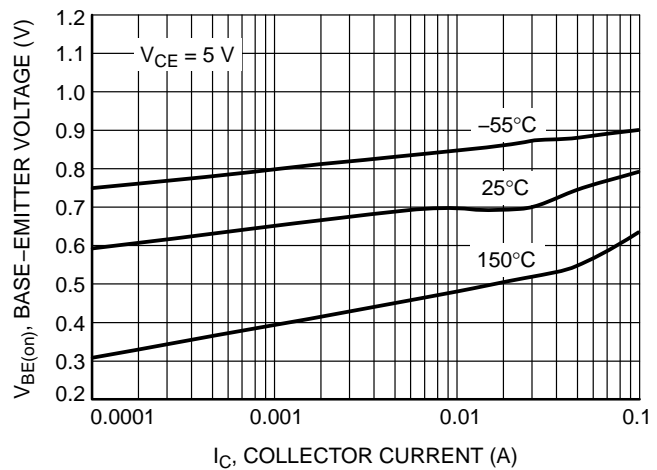

Figure 28. Base Emitter Voltage vs. Collector Current

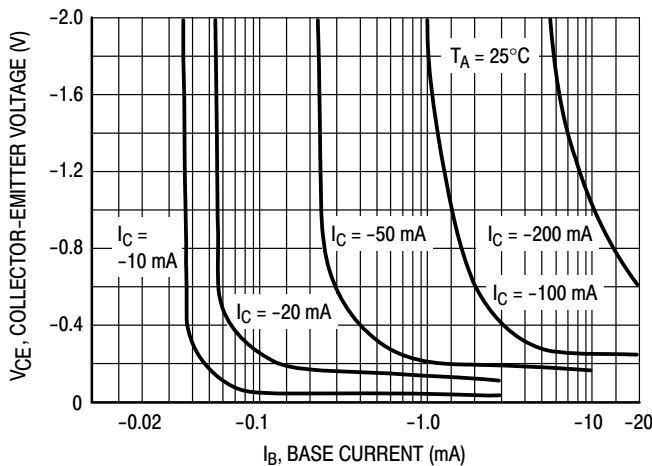

Figure 29. Collector Saturation Region

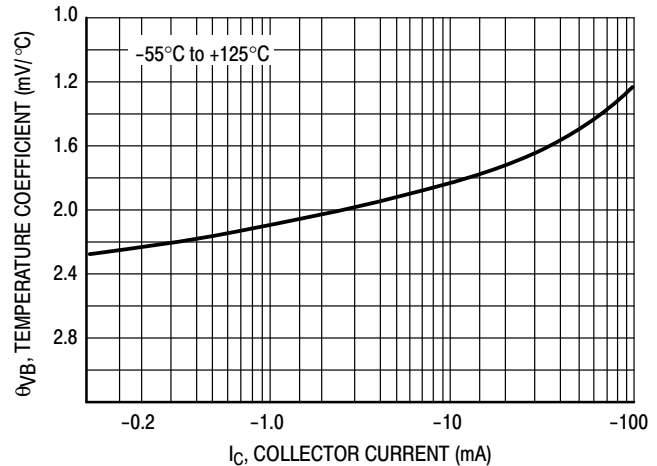

Figure 30. Base-Emitter Temperature Coefficient

BC846BPDW1, BC847BPDW1, BC848CPDW1 Series

TYPICAL PNP CHARACTERISTICS – BC847/SBC847 SERIES

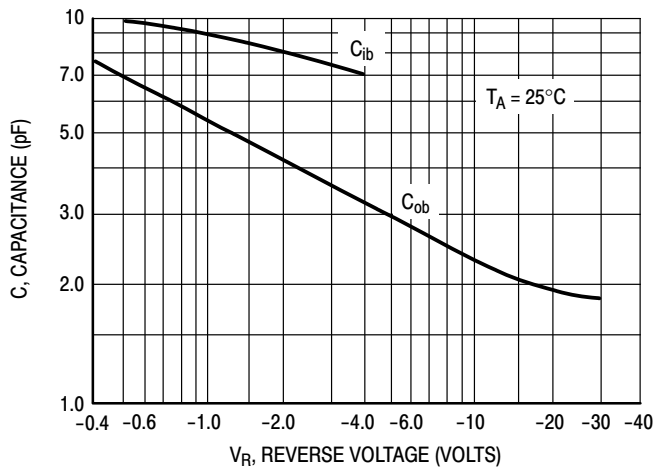

Figure 31. Capacitances

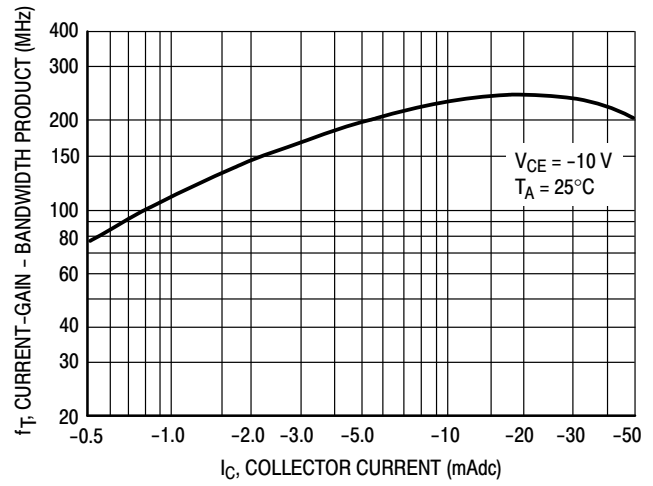

Figure 32. Current-Gain - Bandwidth Product

BC846BPDW1, BC847BPDW1, BC848CPDW1 Series

TYPICAL NPN CHARACTERISTICS – BC848 SERIES

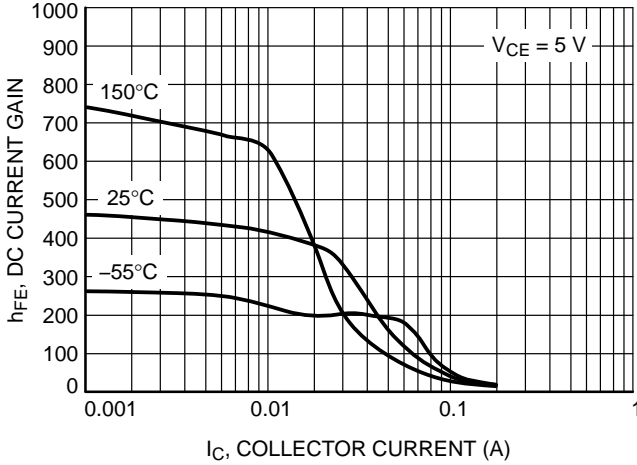

Figure 33. DC Current Gain vs. Collector Current

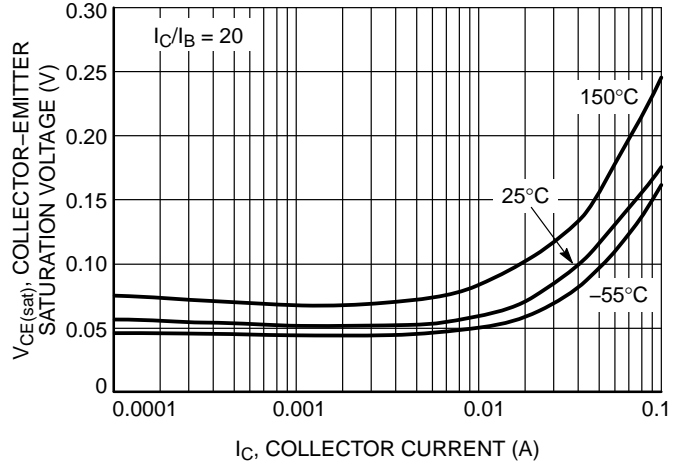

Figure 34. Collector Emitter Saturation Voltage vs. Collector Current

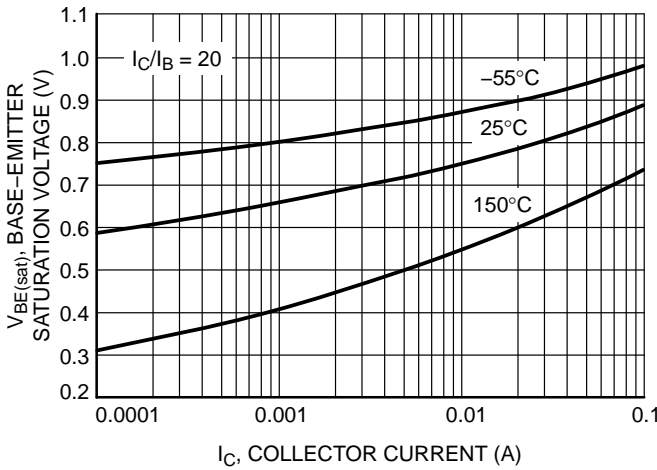

Figure 35. Base Emitter Saturation Voltage vs. Collector Current

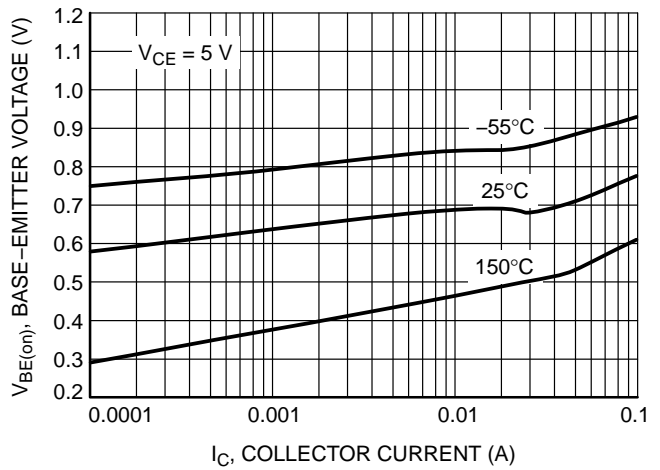

Figure 36. Base Emitter Voltage vs. Collector Current

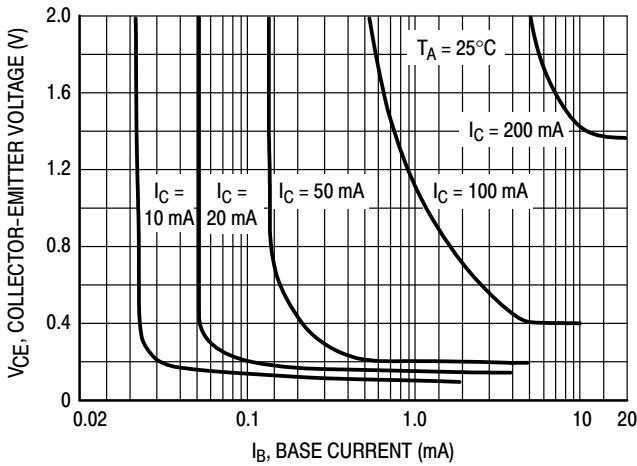

Figure 37. Collector Saturation Region

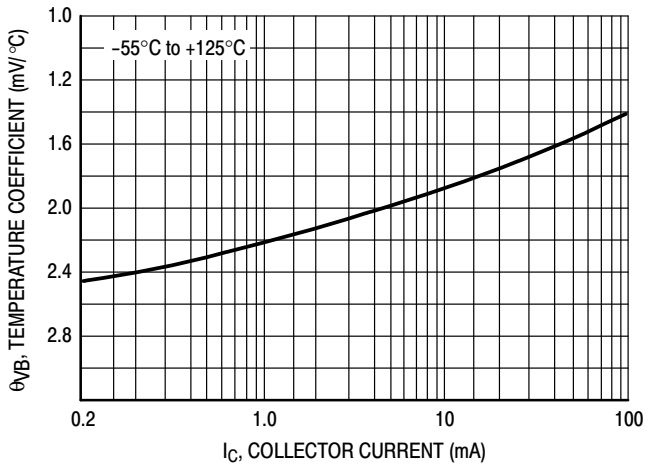

Figure 38. Base-Emitter Temperature Coefficient

BC846BPDW1, BC847BPDW1, BC848CPDW1 Series

TYPICAL NPN CHARACTERISTICS – BC848 SERIES

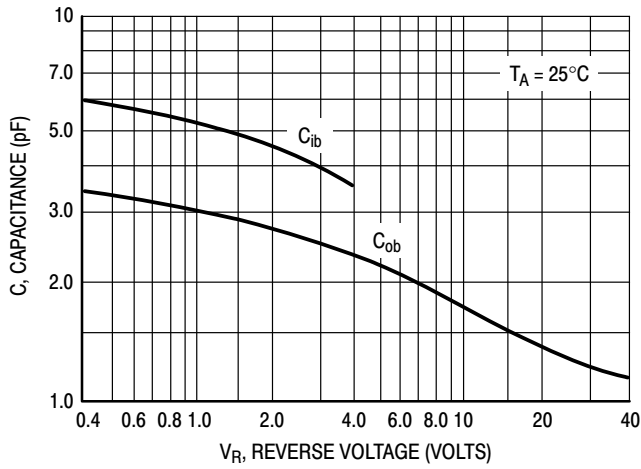

Figure 39. Capacitances

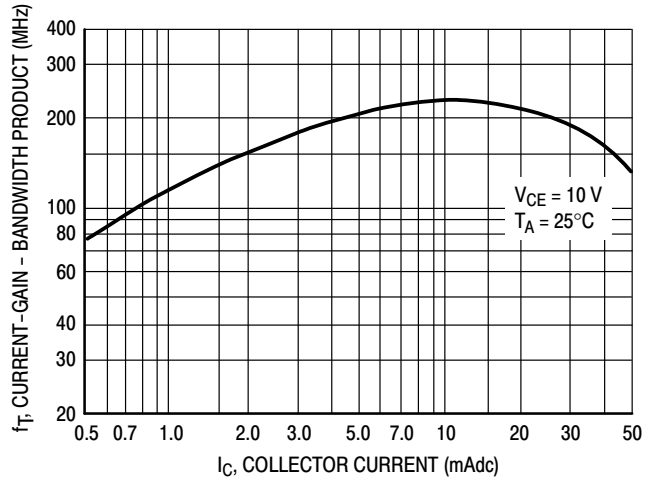

Figure 40. Current-Gain - Bandwidth Product

BC846BPDW1, BC847BPDW1, BC848CPDW1 Series

TYPICAL PNP CHARACTERISTICS – BC848 SERIES

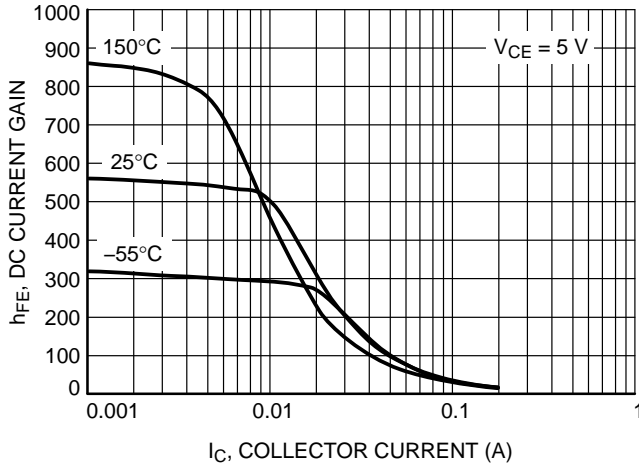

Figure 41. DC Current Gain vs. Collector Current

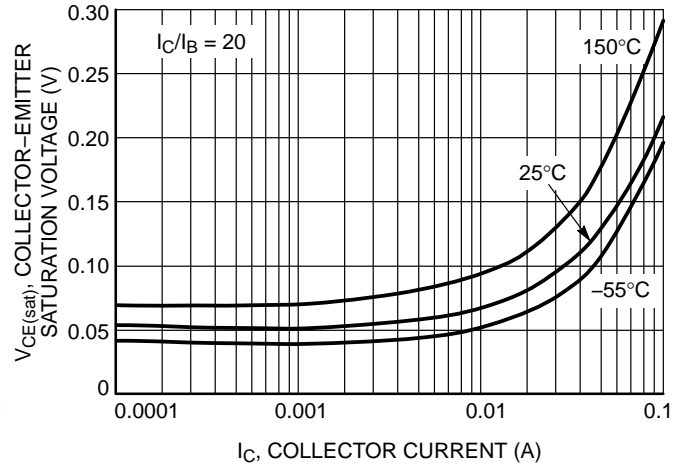

Figure 42. Collector Emitter Saturation Voltage vs. Collector Current

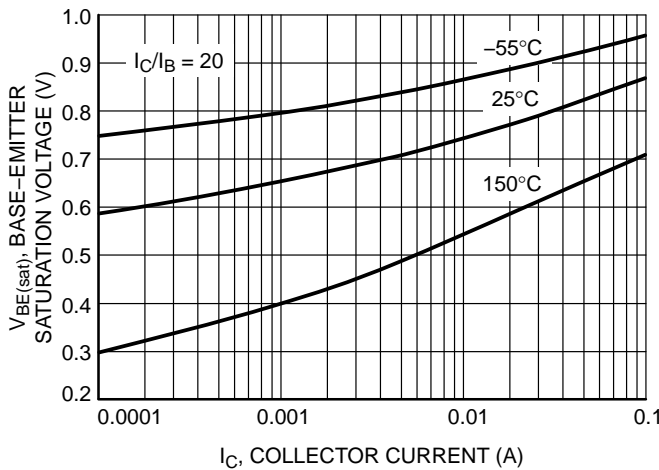

Figure 43. Base Emitter Saturation Voltage vs. Collector Current

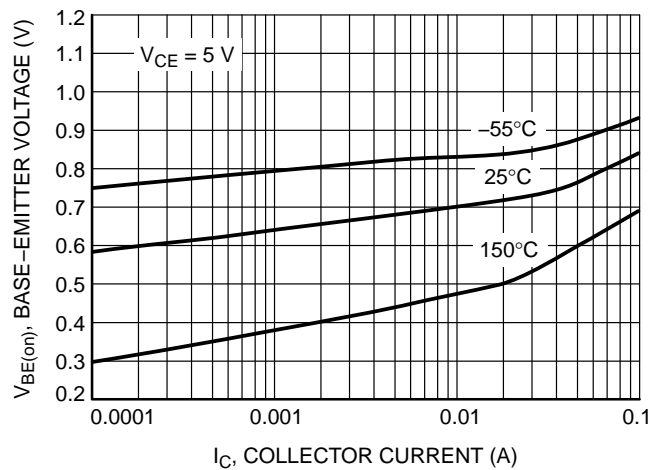

Figure 44. Base Emitter Voltage vs. Collector Current

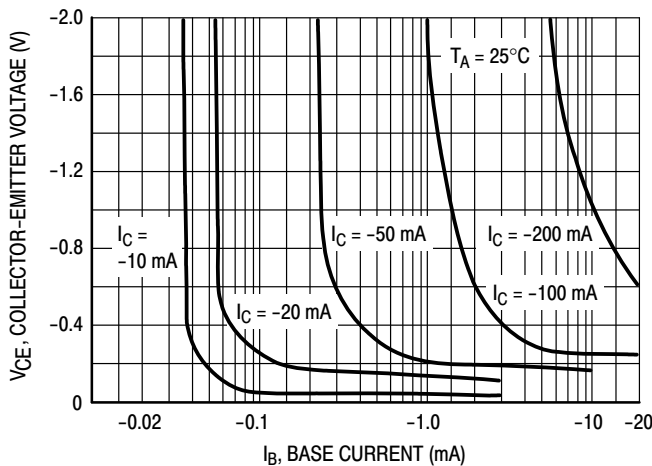

Figure 45. Collector Saturation Region

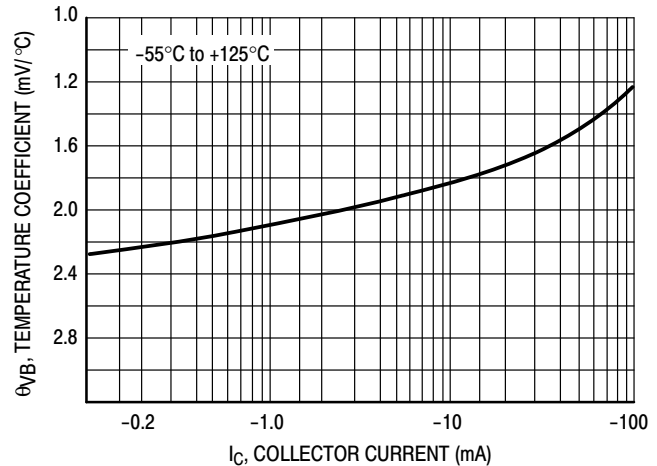

Figure 46. Base-Emitter Temperature Coefficient

BC846BPDW1, BC847BPDW1, BC848CPDW1 Series

TYPICAL PNP CHARACTERISTICS – BC848 SERIES

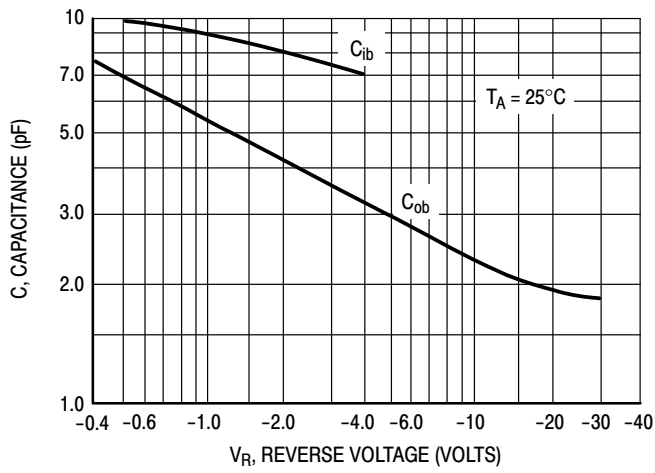

Figure 47. Capacitances

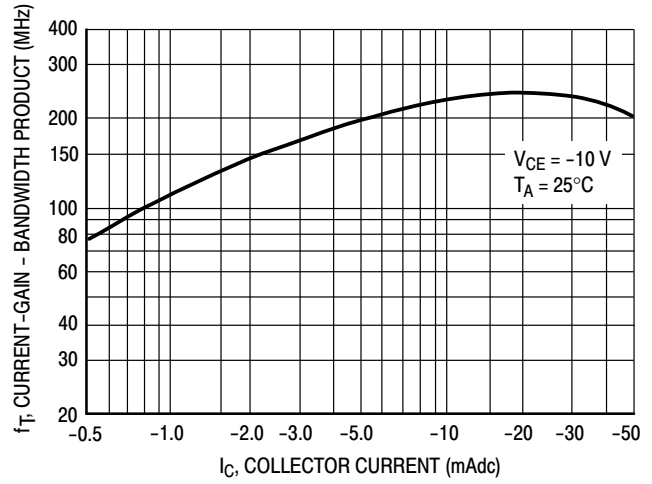

Figure 48. Current-Gain - Bandwidth Product

BC846BPDW1, BC847BPDW1, BC848CPDW1 Series

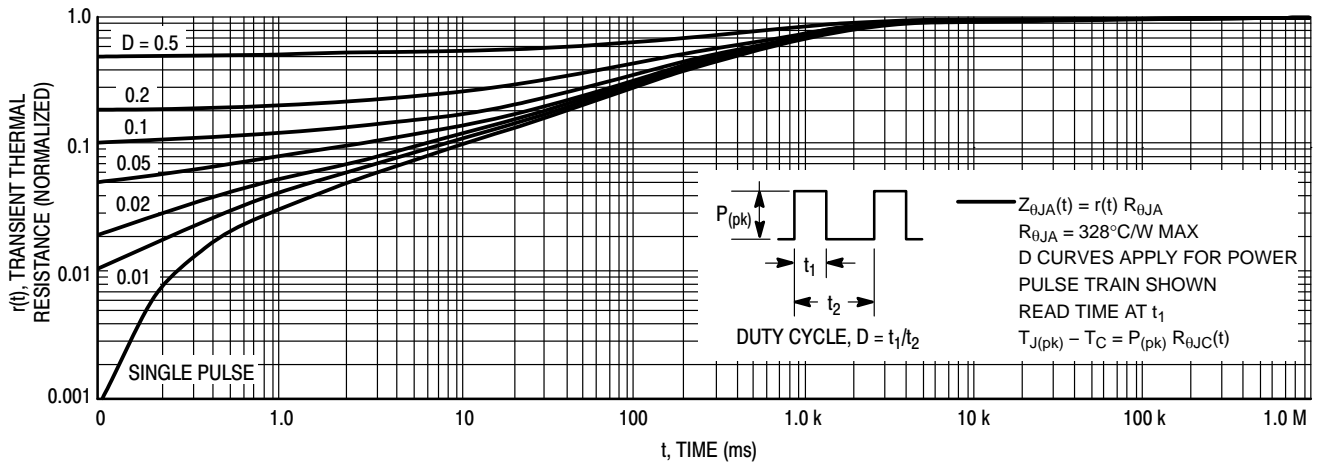

Figure 49. Thermal Response

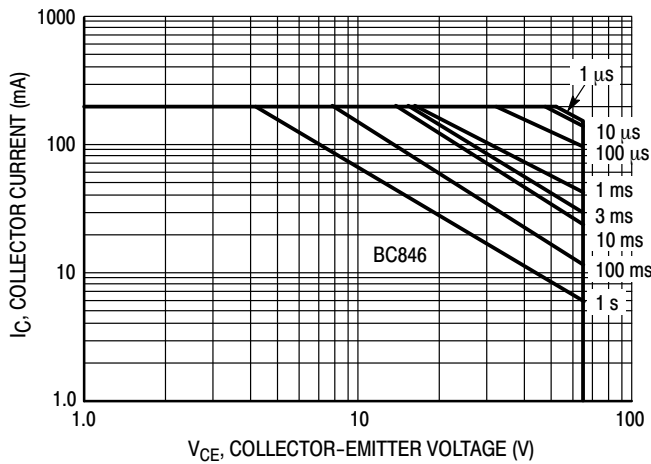

Figure 50. Safe Operating Area – BC846

The safe operating area curves indicate I_C - V_{CE} limits of the transistor that must be observed for reliable operation. Collector load lines for specific circuits must fall below the limits indicated by the applicable curve.

The data of Figure 50 is based upon $T_{J(pk)} = 150^\circ\text{C}$; T_C or T_A is variable depending upon conditions. Pulse curves are valid for duty cycles to 10% provided $T_{J(pk)} \leq 150^\circ\text{C}$. $T_{J(pk)}$ may be calculated from the data in Figure 49. At high case or ambient temperatures, thermal limitations will reduce the power that can be handled to values less than the limitations imposed by the secondary breakdown.

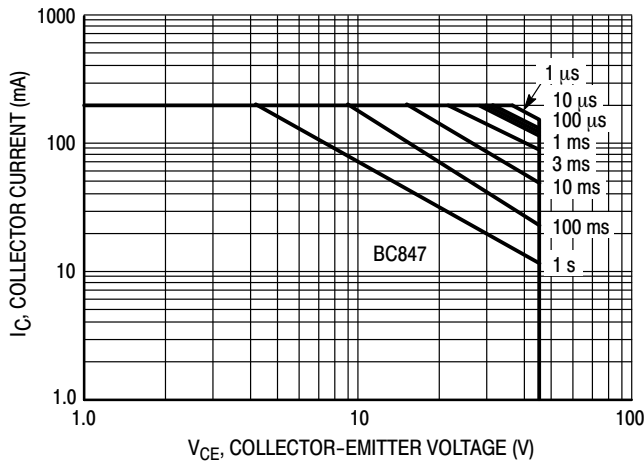

Figure 51. Safe Operating Area – BC847

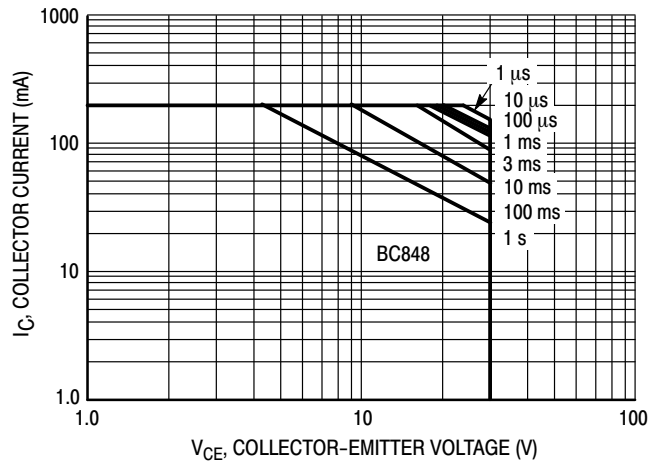

Figure 52. Safe Operating Area – BC848



1
 SCALE 2:1

SC-88/SC70-6/SOT-363
 CASE 419B-02
 ISSUE Y

DATE 11 DEC 2012

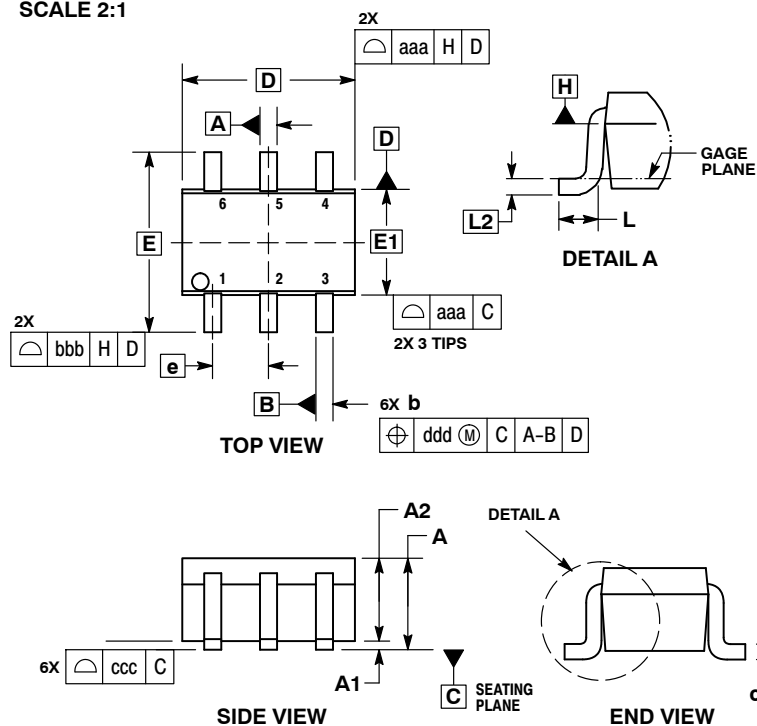

- NOTES:
1. DIMENSIONING AND TOLERANCING PER ASME Y14.5M, 1994.
 2. CONTROLLING DIMENSION: MILLIMETERS.
 3. DIMENSIONS D AND E1 DO NOT INCLUDE MOLD FLASH, PROTRUSIONS, OR GATE BURRS. MOLD FLASH, PROTRUSIONS, OR GATE BURRS SHALL NOT EXCEED 0.20 PER END.
 4. DIMENSIONS D AND E1 AT THE OUTERMOST EXTREMES OF THE PLASTIC BODY AND DATUM H.
 5. DATUMS A AND B ARE DETERMINED AT DATUM H.
 6. DIMENSIONS b AND c APPLY TO THE FLAT SECTION OF THE LEAD BETWEEN 0.08 AND 0.15 FROM THE TIP.
 7. DIMENSION b DOES NOT INCLUDE DAMBAR PROTRUSION. ALLOWABLE DAMBAR PROTRUSION SHALL BE 0.08 TOTAL IN EXCESS OF DIMENSION b AT MAXIMUM MATERIAL CONDITION. THE DAMBAR CANNOT BE LOCATED ON THE LOWER RADIUS OF THE FOOT.

DIM	MILLIMETERS			INCHES		
	MIN	NOM	MAX	MIN	NOM	MAX
A	---	---	1.10	---	---	0.043
A1	0.00	---	0.10	0.000	---	0.004
A2	0.70	0.90	1.00	0.027	0.035	0.039
b	0.15	0.20	0.25	0.006	0.008	0.010
C	0.08	0.15	0.22	0.003	0.006	0.009
D	1.80	2.00	2.20	0.070	0.078	0.086
E	2.00	2.10	2.20	0.078	0.082	0.086
E1	1.15	1.25	1.35	0.045	0.049	0.053
e	0.65 BSC			0.026 BSC		
L	0.26	0.36	0.46	0.010	0.014	0.018
L2	0.15 BSC			0.006 BSC		
aaa	0.15			0.006		
bbb	0.30			0.012		
ccc	0.10			0.004		
ddd	0.10			0.004		

GENERIC MARKING DIAGRAM*

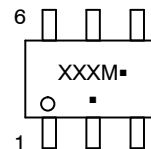

- XXX = Specific Device Code
- M = Date Code*
- = Pb-Free Package

(Note: Microdot may be in either location)

*Date Code orientation and/or position may vary depending upon manufacturing location.

*This information is generic. Please refer to device data sheet for actual part marking. Pb-Free indicator, "G" or microdot "▪", may or may not be present. Some products may not follow the Generic Marking.

RECOMMENDED SOLDERING FOOTPRINT*

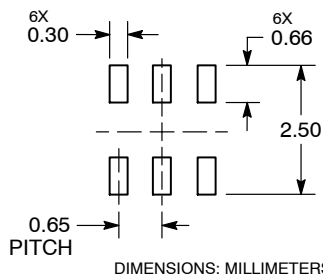

*For additional information on our Pb-Free strategy and soldering details, please download the ON Semiconductor Soldering and Mounting Techniques Reference Manual, SOLDERRM/D.

STYLES ON PAGE 2

DOCUMENT NUMBER:	98ASB42985B	Electronic versions are uncontrolled except when accessed directly from the Document Repository. Printed versions are uncontrolled except when stamped "CONTROLLED COPY" in red.
DESCRIPTION:	SC-88/SC70-6/SOT-363	PAGE 1 OF 2

ON Semiconductor and ON are trademarks of Semiconductor Components Industries, LLC dba ON Semiconductor or its subsidiaries in the United States and/or other countries. ON Semiconductor reserves the right to make changes without further notice to any products herein. ON Semiconductor makes no warranty, representation or guarantee regarding the suitability of its products for any particular purpose, nor does ON Semiconductor assume any liability arising out of the application or use of any product or circuit, and specifically disclaims any and all liability, including without limitation special, consequential or incidental damages. ON Semiconductor does not convey any license under its patent rights nor the rights of others.

SC-88/SC70-6/SOT-363
CASE 419B-02
ISSUE Y

DATE 11 DEC 2012

STYLE 1: PIN 1. EMITTER 2 2. BASE 2 3. COLLECTOR 1 4. EMITTER 1 5. BASE 1 6. COLLECTOR 2	STYLE 2: CANCELLED	STYLE 3: CANCELLED	STYLE 4: PIN 1. CATHODE 2. CATHODE 3. COLLECTOR 4. EMITTER 5. BASE 6. ANODE	STYLE 5: PIN 1. ANODE 2. ANODE 3. COLLECTOR 4. EMITTER 5. BASE 6. CATHODE	STYLE 6: PIN 1. ANODE 2 2. N/C 3. CATHODE 1 4. ANODE 1 5. N/C 6. CATHODE 2
STYLE 7: PIN 1. SOURCE 2 2. DRAIN 2 3. GATE 1 4. SOURCE 1 5. DRAIN 1 6. GATE 2	STYLE 8: CANCELLED	STYLE 9: PIN 1. EMITTER 2 2. EMITTER 1 3. COLLECTOR 1 4. BASE 1 5. BASE 2 6. COLLECTOR 2	STYLE 10: PIN 1. SOURCE 2 2. SOURCE 1 3. GATE 1 4. DRAIN 1 5. DRAIN 2 6. GATE 2	STYLE 11: PIN 1. CATHODE 2 2. CATHODE 2 3. ANODE 1 4. CATHODE 1 5. CATHODE 1 6. ANODE 2	STYLE 12: PIN 1. ANODE 2 2. ANODE 2 3. CATHODE 1 4. ANODE 1 5. ANODE 1 6. CATHODE 2
STYLE 13: PIN 1. ANODE 2. N/C 3. COLLECTOR 4. EMITTER 5. BASE 6. CATHODE	STYLE 14: PIN 1. VREF 2. GND 3. GND 4. IOUT 5. VEN 6. VCC	STYLE 15: PIN 1. ANODE 1 2. ANODE 2 3. ANODE 3 4. CATHODE 3 5. CATHODE 2 6. CATHODE 1	STYLE 16: PIN 1. BASE 1 2. EMITTER 2 3. COLLECTOR 2 4. BASE 2 5. EMITTER 1 6. COLLECTOR 1	STYLE 17: PIN 1. BASE 1 2. EMITTER 1 3. COLLECTOR 2 4. BASE 2 5. EMITTER 2 6. COLLECTOR 1	STYLE 18: PIN 1. VIN1 2. VCC 3. VOUT2 4. VIN2 5. GND 6. VOUT1
STYLE 19: PIN 1. IOUT 2. GND 3. GND 4. V CC 5. V EN 6. V REF	STYLE 20: PIN 1. COLLECTOR 2. COLLECTOR 3. BASE 4. EMITTER 5. COLLECTOR 6. COLLECTOR	STYLE 21: PIN 1. ANODE 1 2. N/C 3. ANODE 2 4. CATHODE 2 5. N/C 6. CATHODE 1	STYLE 22: PIN 1. D1 (i) 2. GND 3. D2 (i) 4. D2 (c) 5. VBUS 6. D1 (c)	STYLE 23: PIN 1. Vn 2. CH1 3. Vp 4. N/C 5. CH2 6. N/C	STYLE 24: PIN 1. CATHODE 2. ANODE 3. CATHODE 4. CATHODE 5. CATHODE 6. CATHODE
STYLE 25: PIN 1. BASE 1 2. CATHODE 3. COLLECTOR 2 4. BASE 2 5. EMITTER 6. COLLECTOR 1	STYLE 26: PIN 1. SOURCE 1 2. GATE 1 3. DRAIN 2 4. SOURCE 2 5. GATE 2 6. DRAIN 1	STYLE 27: PIN 1. BASE 2 2. BASE 1 3. COLLECTOR 1 4. EMITTER 1 5. EMITTER 2 6. COLLECTOR 2	STYLE 28: PIN 1. DRAIN 2. DRAIN 3. GATE 4. SOURCE 5. DRAIN 6. DRAIN	STYLE 29: PIN 1. ANODE 2. ANODE 3. COLLECTOR 4. EMITTER 5. BASE/ANODE 6. CATHODE	STYLE 30: PIN 1. SOURCE 1 2. DRAIN 2 3. DRAIN 2 4. SOURCE 2 5. GATE 1 6. DRAIN 1

Note: Please refer to datasheet for style callout. If style type is not called out in the datasheet refer to the device datasheet pinout or pin assignment.

DOCUMENT NUMBER:	98ASB42985B	Electronic versions are uncontrolled except when accessed directly from the Document Repository. Printed versions are uncontrolled except when stamped "CONTROLLED COPY" in red.
DESCRIPTION:	SC-88/SC70-6/SOT-363	PAGE 2 OF 2

ON Semiconductor and  are trademarks of Semiconductor Components Industries, LLC dba ON Semiconductor or its subsidiaries in the United States and/or other countries. ON Semiconductor reserves the right to make changes without further notice to any products herein. ON Semiconductor makes no warranty, representation or guarantee regarding the suitability of its products for any particular purpose, nor does ON Semiconductor assume any liability arising out of the application or use of any product or circuit, and specifically disclaims any and all liability, including without limitation special, consequential or incidental damages. ON Semiconductor does not convey any license under its patent rights nor the rights of others.

onsemi, **Onsemi**, and other names, marks, and brands are registered and/or common law trademarks of Semiconductor Components Industries, LLC dba "**onsemi**" or its affiliates and/or subsidiaries in the United States and/or other countries. **onsemi** owns the rights to a number of patents, trademarks, copyrights, trade secrets, and other intellectual property. A listing of **onsemi**'s product/patent coverage may be accessed at www.onsemi.com/site/pdf/Patent-Marking.pdf. **onsemi** reserves the right to make changes at any time to any products or information herein, without notice. The information herein is provided "as-is" and **onsemi** makes no warranty, representation or guarantee regarding the accuracy of the information, product features, availability, functionality, or suitability of its products for any particular purpose, nor does **onsemi** assume any liability arising out of the application or use of any product or circuit, and specifically disclaims any and all liability, including without limitation special, consequential or incidental damages. Buyer is responsible for its products and applications using **onsemi** products, including compliance with all laws, regulations and safety requirements or standards, regardless of any support or applications information provided by **onsemi**. "Typical" parameters which may be provided in **onsemi** data sheets and/or specifications can and do vary in different applications and actual performance may vary over time. All operating parameters, including "Typicals" must be validated for each customer application by customer's technical experts. **onsemi** does not convey any license under any of its intellectual property rights nor the rights of others. **onsemi** products are not designed, intended, or authorized for use as a critical component in life support systems or any FDA Class 3 medical devices or medical devices with a same or similar classification in a foreign jurisdiction or any devices intended for implantation in the human body. Should Buyer purchase or use **onsemi** products for any such unintended or unauthorized application, Buyer shall indemnify and hold **onsemi** and its officers, employees, subsidiaries, affiliates, and distributors harmless against all claims, costs, damages, and expenses, and reasonable attorney fees arising out of, directly or indirectly, any claim of personal injury or death associated with such unintended or unauthorized use, even if such claim alleges that **onsemi** was negligent regarding the design or manufacture of the part. **onsemi** is an Equal Opportunity/Affirmative Action Employer. This literature is subject to all applicable copyright laws and is not for resale in any manner.

PUBLICATION ORDERING INFORMATION

LITERATURE FULFILLMENT:

Email Requests to: orderlit@onsemi.com

onsemi Website: www.onsemi.com

TECHNICAL SUPPORT

North American Technical Support:

Voice Mail: 1 800-282-9855 Toll Free USA/Canada

Phone: 011 421 33 790 2910

Europe, Middle East and Africa Technical Support:

Phone: 00421 33 790 2910

For additional information, please contact your local Sales Representative

X-ON Electronics

Largest Supplier of Electrical and Electronic Components

Click to view similar products for [Bipolar Transistors - BJT category](#):

Click to view products by [ON Semiconductor manufacturer](#):

Other Similar products are found below :

[619691C](#) [MCH4017-TL-H](#) [BC546/116](#) [BC557/116](#) [BSW67A](#) [NTE158](#) [NTE187A](#) [NTE195A](#) [NTE2302](#) [NTE2330](#) [NTE63](#) [C4460](#)
[2SA1419T-TD-H](#) [2SA1721-O\(TE85L,F\)](#) [2SA2126-E](#) [2SB1204S-TL-E](#) [2SC5488A-TL-H](#) [2SD2150T100R](#) [SP000011176](#) [FMMTA92QTA](#)
[2N2369ADCSM](#) [2SC2412KT146S](#) [2SC5490A-TL-H](#) [2SD1816S-TL-E](#) [2SD1816T-TL-E](#) [CMXT2207 TR](#) [CPH6501-TL-E](#) [MCH4021-TL-E](#)
[US6T6TR](#) [732314D](#) [CMXT3906 TR](#) [CPH3121-TL-E](#) [CPH6021-TL-H](#) [873787E](#) [UMX21NTR](#) [EMT2T2R](#) [MCH6102-TL-E](#) [FP204-TL-E](#)
[NJL0302DG](#) [2N3583](#) [2SA1434-TB-E](#) [2SC3143-4-TB-E](#) [2SD1621S-TD-E](#) [NTE103](#) [30A02MH-TL-E](#) [NSV40301MZ4T1G](#) [NTE101](#) [NTE13](#)
[NTE15](#) [NTE16001](#)