



Is Now Part of



**ON Semiconductor®**

To learn more about ON Semiconductor, please visit our website at  
[www.onsemi.com](http://www.onsemi.com)

Please note: As part of the Fairchild Semiconductor integration, some of the Fairchild orderable part numbers will need to change in order to meet ON Semiconductor's system requirements. Since the ON Semiconductor product management systems do not have the ability to manage part nomenclature that utilizes an underscore (\_), the underscore (\_) in the Fairchild part numbers will be changed to a dash (-). This document may contain device numbers with an underscore (\_). Please check the ON Semiconductor website to verify the updated device numbers. The most current and up-to-date ordering information can be found at [www.onsemi.com](http://www.onsemi.com). Please email any questions regarding the system integration to [Fairchild\\_questions@onsemi.com](mailto:Fairchild_questions@onsemi.com).

ON Semiconductor and the ON Semiconductor logo are trademarks of Semiconductor Components Industries, LLC dba ON Semiconductor or its subsidiaries in the United States and/or other countries. ON Semiconductor owns the rights to a number of patents, trademarks, copyrights, trade secrets, and other intellectual property. A listing of ON Semiconductor's product/patent coverage may be accessed at [www.onsemi.com/site/pdf/Patent-Marking.pdf](http://www.onsemi.com/site/pdf/Patent-Marking.pdf). ON Semiconductor reserves the right to make changes without further notice to any products herein. ON Semiconductor makes no warranty, representation or guarantee regarding the suitability of its products for any particular purpose, nor does ON Semiconductor assume any liability arising out of the application or use of any product or circuit, and specifically disclaims any and all liability, including without limitation special, consequential or incidental damages. Buyer is responsible for its products and applications using ON Semiconductor products, including compliance with all laws, regulations and safety requirements or standards, regardless of any support or applications information provided by ON Semiconductor. "Typical" parameters which may be provided in ON Semiconductor data sheets and/or specifications can and do vary in different applications and actual performance may vary over time. All operating parameters, including "Typicals" must be validated for each customer application by customer's technical experts. ON Semiconductor does not convey any license under its patent rights nor the rights of others. ON Semiconductor products are not designed, intended, or authorized for use as a critical component in life support systems or any FDA Class 3 medical devices or medical devices with a same or similar classification in a foreign jurisdiction or any devices intended for implantation in the human body. Should Buyer purchase or use ON Semiconductor products for any such unintended or unauthorized application, Buyer shall indemnify and hold ON Semiconductor and its officers, employees, subsidiaries, affiliates, and distributors harmless against all claims, costs, damages, and expenses, and reasonable attorney fees arising out of, directly or indirectly, any claim of personal injury or death associated with such unintended or unauthorized use, even if such claim alleges that ON Semiconductor was negligent regarding the design or manufacture of the part. ON Semiconductor is an Equal Opportunity/Affirmative Action Employer. This literature is subject to all applicable copyright laws and is not for resale in any manner.

## BCP54

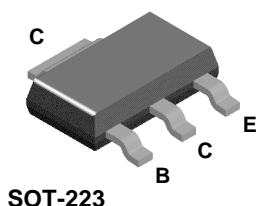

### NPN General Purpose Amplifier

This device is designed for general purpose medium power amplifiers and switching circuits requiring collector currents to 1.2 A. Sourced from Process 38.

#### Absolute Maximum Ratings\* TA = 25°C unless otherwise noted

Symbol	Parameter	Value	Units
$V_{CEO}$	Collector-Emitter Voltage	45	V
$V_{CBO}$	Collector-Base Voltage	45	V
$V_{EBO}$	Emitter-Base Voltage	5.0	V
$I_C$	Collector Current - Continuous	1.5	A
$T_J, T_{stg}$	Operating and Storage Junction Temperature Range	-55 to +150	°C

\*These ratings are limiting values above which the serviceability of any semiconductor device may be impaired.

**NOTES:**

- 1) These ratings are based on a maximum junction temperature of 150 degrees C.
- 2) These are steady state limits. The factory should be consulted on applications involving pulsed or low duty cycle operations.

#### Thermal Characteristics TA = 25°C unless otherwise noted

Symbol	Characteristic	Max	Units
		BCP54	
$P_D$	Total Device Dissipation	1.5	W
	Derate above 25°C	12	mW/°C
$R_{\theta JA}$	Thermal Resistance, Junction to Ambient	83.3	°C/W

# NPN General Purpose Amplifier

(continued)

BCP54

## Electrical Characteristics

TA = 25°C unless otherwise noted

Symbol	Parameter	Test Conditions	Min	Max	Units
<b>OFF CHARACTERISTICS</b>					
$V_{(BR)CEO}$	Collector-Emitter Breakdown Voltage	$I_C = 10 \text{ mA}, I_B = 0$	45		V
$V_{(BR)CBO}$	Collector-Base Breakdown Voltage	$I_C = 100 \mu\text{A}, I_E = 0$	45		V
$V_{(BR)EBO}$	Emitter-Base Breakdown Voltage	$I_E = 10 \mu\text{A}, I_C = 0$	5.0		V
$I_{CBO}$	Collector-Cutoff Current	$V_{CB} = 30 \text{ V}, I_E = 0$ $V_{CB} = 30 \text{ V}, I_E = 0, T_A = 125^\circ\text{C}$		100 10	nA $\mu\text{A}$
$I_{EBO}$	Emitter-Cutoff Current	$V_{EB} = 5.0 \text{ V}, I_C = 0$		10	$\mu\text{A}$

## ON CHARACTERISTICS

$h_{FE}$	DC Current Gain	$I_C = 5.0 \text{ mA}, V_{CE} = 2.0 \text{ V}$ $I_C = 150 \text{ mA}, V_{CE} = 2.0 \text{ V}$ $I_C = 500 \text{ mA}, V_{CE} = 2.0 \text{ V}$	25 40 25	250	
$V_{CE(sat)}$	Collector-Emitter Saturation Voltage	$I_C = 500 \text{ mA}, I_B = 50 \text{ mA}$		0.5	V
$V_{BE(on)}$	Base-Emitter On Voltage	$I_C = 500 \text{ mA}, V_{CE} = 2.0 \text{ V}$		1.0	V

## Typical Characteristics

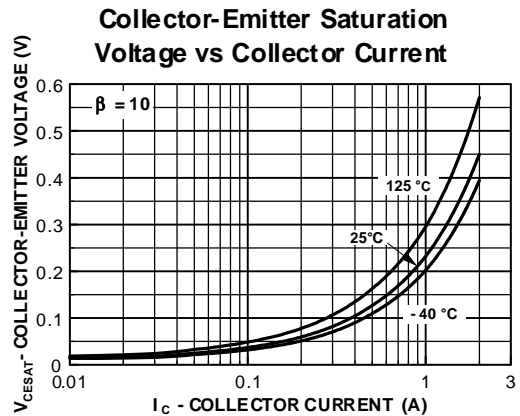
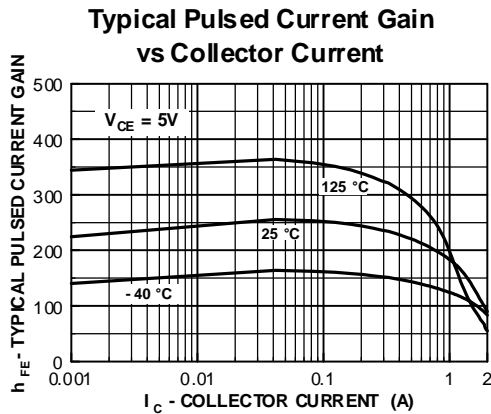

Typical Characteristics (continued)

Base-Emitter Saturation Voltage vs Collector Current

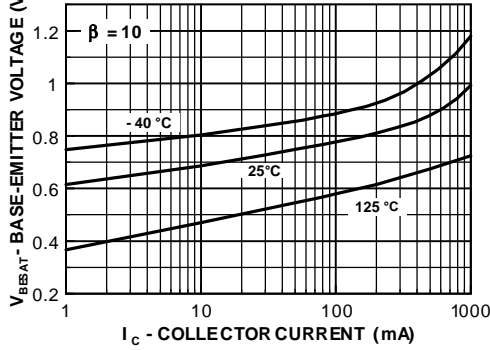

Base-Emitter ON Voltage vs Collector Current

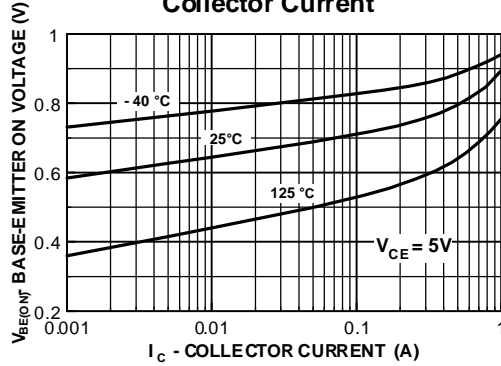

Collector-Cutoff Current vs Ambient Temperature

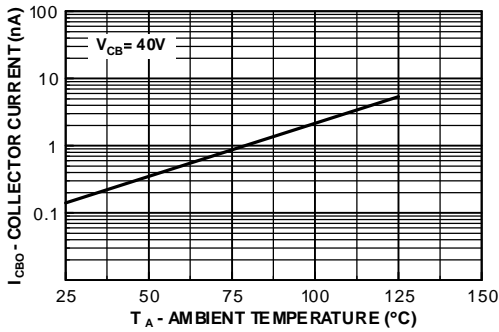

Collector-Base Capacitance vs Collector-Base Voltage

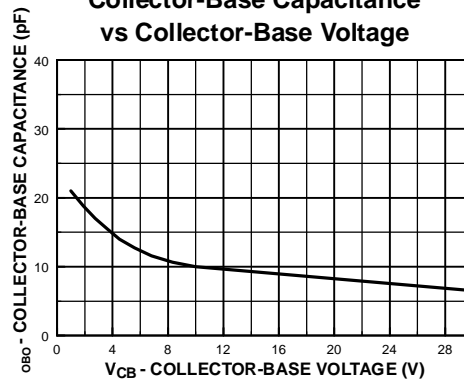

Gain Bandwidth Product vs Collector Current

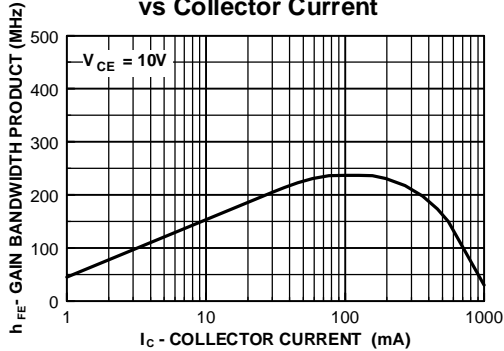

Power Dissipation vs Ambient Temperature

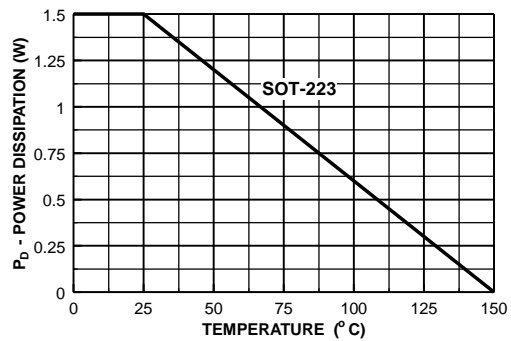

# SOT-223 Tape and Reel Data



## SOT-223 Packaging Configuration: Figure 1.0

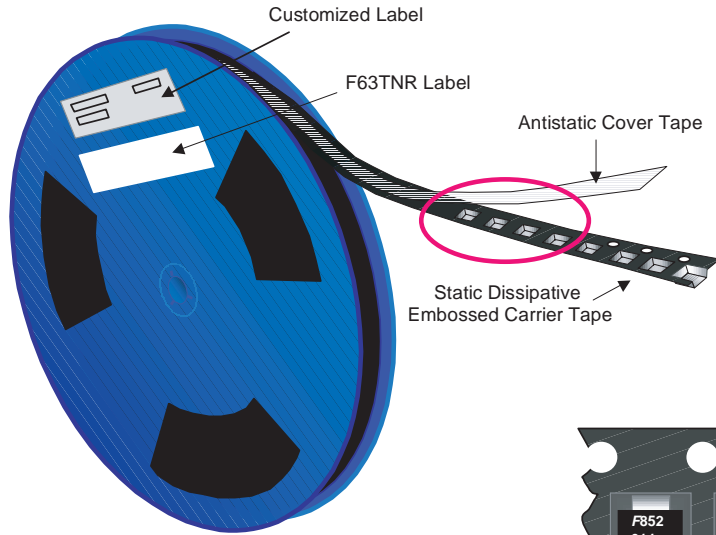

**Packaging Description:**  
 SOT-223 parts are shipped in tape. The carrier tape is made from a dissipative (carbon filled) polycarbonate resin. The cover tape is a multilayer film (Heat Activated Adhesive in nature) primarily composed of polyester film, adhesive layer, sealant, and anti-static sprayed agent. These reeled parts in standard option are shipped with 2,500 units per 13" or 330cm diameter reel. The reels are dark blue in color and is made of polystyrene plastic (anti-static coated). Other option comes in 500 units per 7" or 177cm diameter reel. This and some other options are further described in the Packaging Information table.  
 These full reels are individually barcode labeled and placed inside a standard intermediate box (illustrated in figure 1.0) made of recyclable corrugated brown paper. One box contains two reels maximum. And these boxes are placed inside a barcode labeled shipping box which comes in different sizes depending on the number of parts shipped.

SOT-223 Packaging Information		
Packaging Option	Standard (no flow code)	D84Z
Packaging type	TNR	TNR
Qty per Reel/Tube/Bag	2,500	500
Reel Size	13" Dia	7" Dia
Box Dimension (mm)	343x64x343	184x187x47
Max qty per Box	5,000	1,000
Weight per unit (gm)	0.1246	0.1246
Weight per Reel (kg)	0.7250	0.1532
Note/Comments		

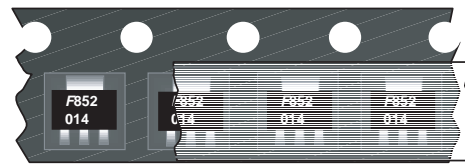

### SOT-223 Unit Orientation

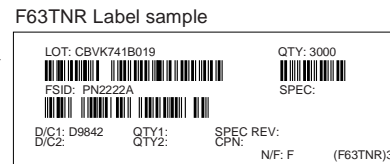
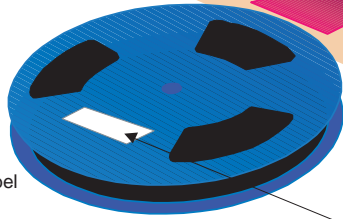
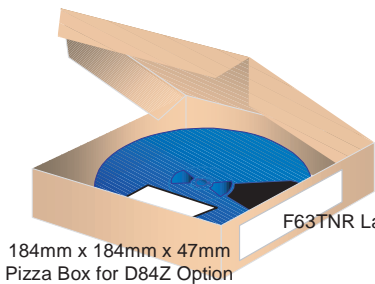
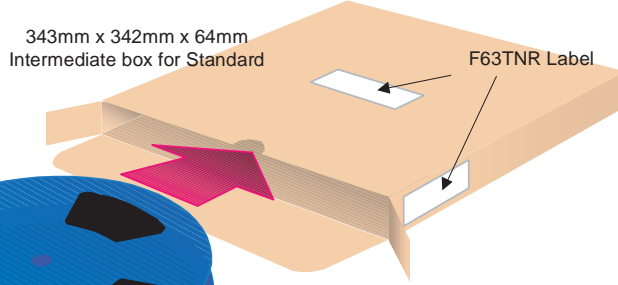

## SOT-223 Tape Leader and Trailer Configuration: Figure 2.0

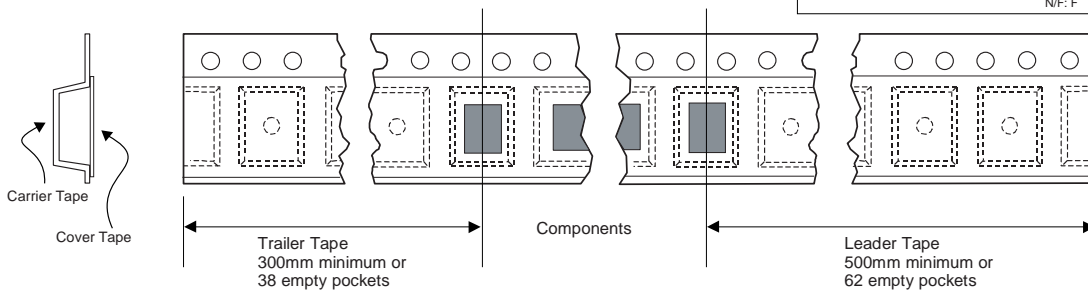

# SOT-223 Tape and Reel Data, continued

## SOT-223 Embossed Carrier Tape Configuration: Figure 3.0

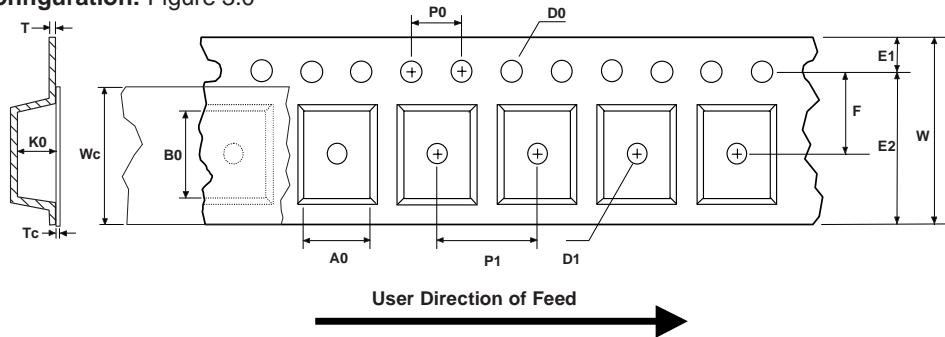

Dimensions are in millimeter														
Pkg type	A0	B0	W	D0	D1	E1	E2	F	P1	P0	K0	T	Wc	Tc
SOT-223 (12mm)	6.83 +/-0.10	7.42 +/-0.10	12.0 +/-0.3	1.55 +/-0.05	1.50 +/-0.10	1.75 +/-0.10	10.25 min	5.50 +/-0.05	8.0 +/-0.1	4.0 +/-0.1	1.88 +/-0.10	0.292 +/- 0.0130	9.5 +/-0.025	0.06 +/-0.02

Notes: A0, B0, and K0 dimensions are determined with respect to the EIA/Jedec RS-481 rotational and lateral movement requirements (see sketches A, B, and C).

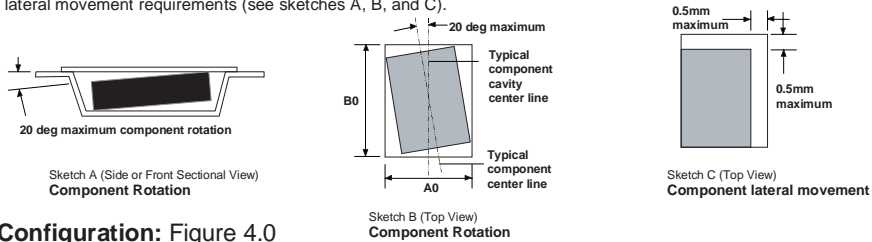

## SOT-223 Reel Configuration: Figure 4.0

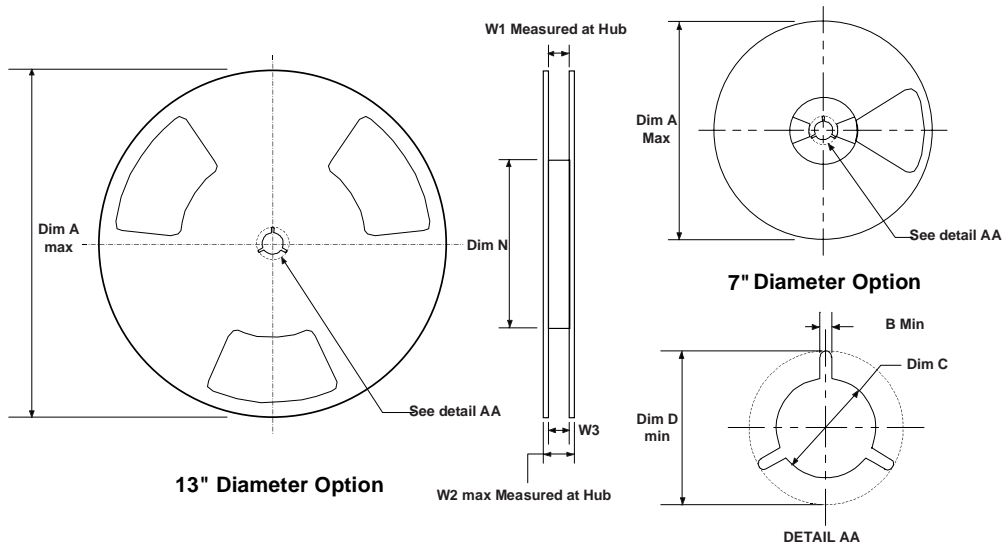

Dimensions are in inches and millimeters									
Tape Size	Reel Option	Dim A	Dim B	Dim C	Dim D	Dim N	Dim W1	Dim W2	Dim W3 (LSL-USL)
12mm	7" Dia	7.00 177.8	0.059 1.5	512 +0.020/-0.008 13 +0.5/-0.2	0.795 20.2	5.906 150	0.488 +0.078/-0.000 12.4 +2/0	0.724 18.4	0.469 - 0.606 11.9 - 15.4
12mm	13" Dia	13.00 330	0.059 1.5	512 +0.020/-0.008 13 +0.5/-0.2	0.795 20.2	7.00 178	0.488 +0.078/-0.000 12.4 +2/0	0.724 18.4	0.469 - 0.606 11.9 - 15.4

# SOT-223 Package Dimensions



## SOT-223 (FS PKG Code 47)

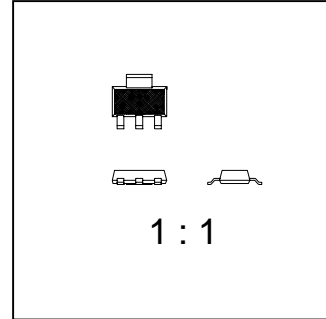
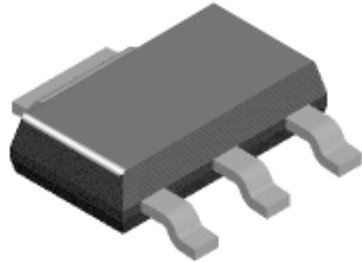

Scale 1:1 on letter size paper

Part Weight per unit (gram): 0.1246

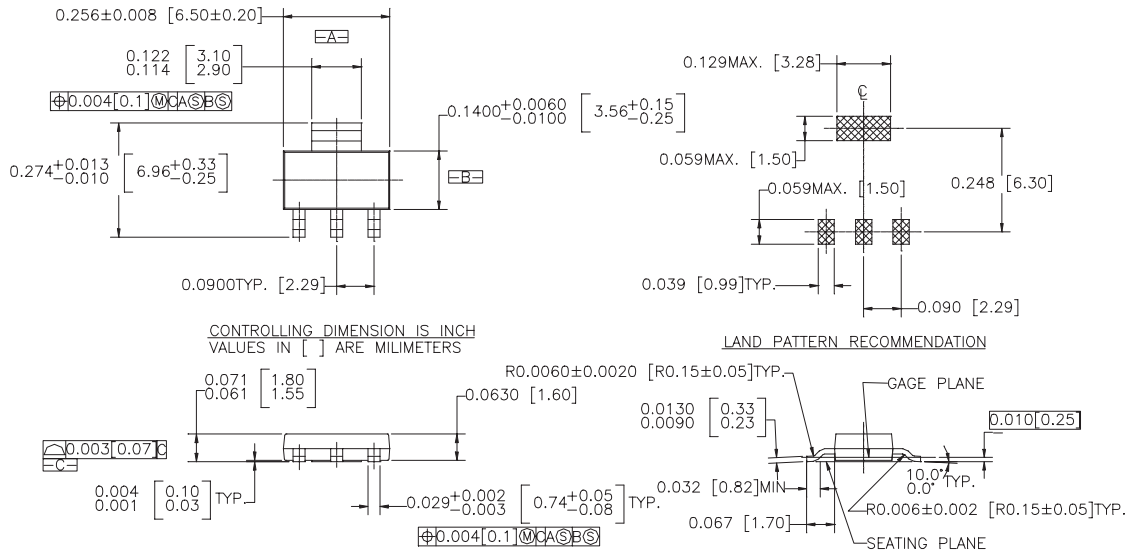

- NOTES : UNLESS OTHERWISE SPECIFIED
- STANDARD LEAD FINISH TO BE 150 MICRONS/ 3.81 MICROMETERS MINIMUM TIN/LEAD (SOLDER) ON COPPER.
  - REFERENCE JEDEC REGISTRATION TO-261, VARIATION AA, ISSUE A, DATED JAN 1990

## TRADEMARKS

The following are registered and unregistered trademarks Fairchild Semiconductor owns or is authorized to use and is not intended to be an exhaustive list of all such trademarks.

ACEx™	FASTr™	PowerTrench®	SyncFET™
Bottomless™	GlobalOptoisolator™	QFET™	TinyLogic™
CoolFET™	GTO™	QS™	UHC™
CROSSVOLT™	HiSeC™	QT Optoelectronics™	VCX™
DOME™	ISOPLANAR™	Quiet Series™	
E <sup>2</sup> CMOS™	MICROWIRE™	SILENT SWITCHER®	
EnSigna™	OPTOLOGIC™	SMART START™	
FACT™	OPTOPLANAR™	SuperSOT™-3	
FACT Quiet Series™	PACMAN™	SuperSOT™-6	
FAST®	POP™	SuperSOT™-8	

## DISCLAIMER

FAIRCHILD SEMICONDUCTOR RESERVES THE RIGHT TO MAKE CHANGES WITHOUT FURTHER NOTICE TO ANY PRODUCTS HEREIN TO IMPROVE RELIABILITY, FUNCTION OR DESIGN. FAIRCHILD DOES NOT ASSUME ANY LIABILITY ARISING OUT OF THE APPLICATION OR USE OF ANY PRODUCT OR CIRCUIT DESCRIBED HEREIN; NEITHER DOES IT CONVEY ANY LICENSE UNDER ITS PATENT RIGHTS, NOR THE RIGHTS OF OTHERS.

## LIFE SUPPORT POLICY

FAIRCHILD'S PRODUCTS ARE NOT AUTHORIZED FOR USE AS CRITICAL COMPONENTS IN LIFE SUPPORT DEVICES OR SYSTEMS WITHOUT THE EXPRESS WRITTEN APPROVAL OF FAIRCHILD SEMICONDUCTOR CORPORATION. As used herein:

1. Life support devices or systems are devices or systems which, (a) are intended for surgical implant into the body, or (b) support or sustain life, or (c) whose failure to perform when properly used in accordance with instructions for use provided in the labeling, can be reasonably expected to result in significant injury to the user.
2. A critical component is any component of a life support device or system whose failure to perform can be reasonably expected to cause the failure of the life support device or system, or to affect its safety or effectiveness.

## PRODUCT STATUS DEFINITIONS

### Definition of Terms

Datasheet Identification	Product Status	Definition
Advance Information	Formative or In Design	This datasheet contains the design specifications for product development. Specifications may change in any manner without notice.
Preliminary	First Production	This datasheet contains preliminary data, and supplementary data will be published at a later date. Fairchild Semiconductor reserves the right to make changes at any time without notice in order to improve design.
No Identification Needed	Full Production	This datasheet contains final specifications. Fairchild Semiconductor reserves the right to make changes at any time without notice in order to improve design.
Obsolete	Not In Production	This datasheet contains specifications on a product that has been discontinued by Fairchild semiconductor. The datasheet is printed for reference information only.



ON Semiconductor and  are trademarks of Semiconductor Components Industries, LLC dba ON Semiconductor or its subsidiaries in the United States and/or other countries. ON Semiconductor owns the rights to a number of patents, trademarks, copyrights, trade secrets, and other intellectual property. A listing of ON Semiconductor's product/patent coverage may be accessed at [www.onsemi.com/site/pdf/Patent-Marking.pdf](http://www.onsemi.com/site/pdf/Patent-Marking.pdf). ON Semiconductor reserves the right to make changes without further notice to any products herein. ON Semiconductor makes no warranty, representation or guarantee regarding the suitability of its products for any particular purpose, nor does ON Semiconductor assume any liability arising out of the application or use of any product or circuit, and specifically disclaims any and all liability, including without limitation special, consequential or incidental damages. Buyer is responsible for its products and applications using ON Semiconductor products, including compliance with all laws, regulations and safety requirements or standards, regardless of any support or applications information provided by ON Semiconductor. "Typical" parameters which may be provided in ON Semiconductor data sheets and/or specifications can and do vary in different applications and actual performance may vary over time. All operating parameters, including "Typicals" must be validated for each customer application by customer's technical experts. ON Semiconductor does not convey any license under its patent rights nor the rights of others. ON Semiconductor products are not designed, intended, or authorized for use as a critical component in life support systems or any FDA Class 3 medical devices or medical devices with a same or similar classification in a foreign jurisdiction or any devices intended for implantation in the human body. Should Buyer purchase or use ON Semiconductor products for any such unintended or unauthorized application, Buyer shall indemnify and hold ON Semiconductor and its officers, employees, subsidiaries, affiliates, and distributors harmless against all claims, costs, damages, and expenses, and reasonable attorney fees arising out of, directly or indirectly, any claim of personal injury or death associated with such unintended or unauthorized use, even if such claim alleges that ON Semiconductor was negligent regarding the design or manufacture of the part. ON Semiconductor is an Equal Opportunity/Affirmative Action Employer. This literature is subject to all applicable copyright laws and is not for resale in any manner.

## PUBLICATION ORDERING INFORMATION

### LITERATURE FULFILLMENT:

Literature Distribution Center for ON Semiconductor  
19521 E. 32nd Pkwy, Aurora, Colorado 80011 USA  
**Phone:** 303-675-2175 or 800-344-3860 Toll Free USA/Canada  
**Fax:** 303-675-2176 or 800-344-3867 Toll Free USA/Canada  
**Email:** [orderlit@onsemi.com](mailto:orderlit@onsemi.com)

**N. American Technical Support:** 800-282-9855 Toll Free  
USA/Canada  
**Europe, Middle East and Africa Technical Support:**  
Phone: 421 33 790 2910  
**Japan Customer Focus Center**  
Phone: 81-3-5817-1050

**ON Semiconductor Website:** [www.onsemi.com](http://www.onsemi.com)  
**Order Literature:** <http://www.onsemi.com/orderlit>  
For additional information, please contact your local  
Sales Representative

## X-ON Electronics

Largest Supplier of Electrical and Electronic Components

*Click to view similar products for [Bipolar Transistors - BJT category](#):*

*Click to view products by [ON Semiconductor manufacturer](#):*

Other Similar products are found below :

[619691C](#) [MCH4017-TL-H](#) [BC546/116](#) [BC557/116](#) [BSW67A](#) [NTE158](#) [NTE187A](#) [NTE195A](#) [NTE2302](#) [NTE2330](#) [NTE63](#) [C4460](#)  
[2SA1419T-TD-H](#) [2SA1721-O\(TE85L,F\)](#) [2SA2126-E](#) [2SB1204S-TL-E](#) [2SC5488A-TL-H](#) [2SD2150T100R](#) [SP000011176](#) [FMMTA92QTA](#)  
[2N2369ADCSM](#) [2SC2412KT146S](#) [2SC5490A-TL-H](#) [2SD1816S-TL-E](#) [2SD1816T-TL-E](#) [CMXT2207 TR](#) [CPH6501-TL-E](#) [MCH4021-TL-E](#)  
[US6T6TR](#) [732314D](#) [CMXT3906 TR](#) [CPH3121-TL-E](#) [CPH6021-TL-H](#) [873787E](#) [IMZ2AT108](#) [UMX21NTR](#) [EMT2T2R](#) [MCH6102-TL-E](#)  
[FP204-TL-E](#) [NJL0302DG](#) [2N3583](#) [2SA1434-TB-E](#) [2SC3143-4-TB-E](#) [2SD1621S-TD-E](#) [NTE103](#) [30A02MH-TL-E](#) [NSV40301MZ4T1G](#)  
[NTE101](#) [NTE13](#) [NTE15](#)