

CAT6201, CAV6201B

LDO Regulator - Adjustable CMOS

300 mA, 13 V

Description

The CAT6201/CAV6201B is a 13 V rated 300 mA CMOS low dropout regulator that provides fast response time to load current and line voltage changes in an automotive environment.

CAT6201/CAV6201B features a low R_{ON} P-channel pass element with internal control circuitry which prevents reverse current flow should the voltage at V_{OUT} exceed V_{IN} as in the case of the car's battery voltage accidentally being applied to V_{OUT} .

Thermal protection and current limiting circuitry combine to protect the pass device against faults and abuse. Current limiting is user controlled through a single resistor to ground. A fault output (\overline{FLT}) provides an alert should an over-current event or thermal shutdown occur.

CAT6201/CAV6201B comes on-line gracefully even though it may be driving heavy capacitive loads thanks to built-in soft-start circuitry. Its output is protected against accidental connection to voltages greater than V_{IN} and will not conduct current backwards into its supply.

CAT6201/CAV6201B is available in 8-pad 2 mm x 3 mm TDFN package.

Features

- Guaranteed 300 mA Continuous Output Current
- Low Dropout Voltage of 250 mV Typical at 300 mA
- Input Voltage Range: 3.3 V to 13.5 V
- User Adjustable Output Voltage
- User Programmable Current Limit
- Fault Output to Indicate Under-voltage, Current Limiting or Thermal Shutdown has Occurred
- Fault Blanking: 3 ms
- V_{OUT} Withstands Battery Fault Voltages of up to 14 V
- Soft-Start Prevents Current Surges
- Stable with Ceramic Output Capacitor
- $\pm 1.5\%$ Output Voltage Initial Accuracy
- $\pm 2.5\%$ Accuracy Over Temperature
- Thermal Protection
- 8 Pad TDFN Package
- CAV Prefix for Automotive and Other Applications Requiring Unique Site and Control Change Requirements; AEC-Q100 Qualified and PPAP Capable
- These Devices are Pb-Free, Halogen Free/BFR Free and are RoHS Compliant



ON Semiconductor®

<http://onsemi.com>



**TDFN-8
VP2 SUFFIX
CASE 511AK**

PIN CONNECTIONS

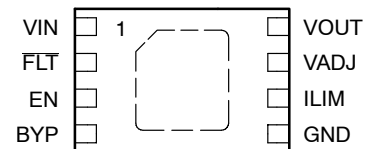

TDFN-8
(Top View)

MARKING DIAGRAMS

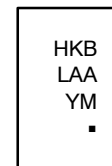

- HKB = CAT6201VP2-GT3 or CAV6201BVP2-GT3
- L = Assembly Location
- AA = Last Two Digits of Assembly Lot Number
- Y = Production Year (Last Digit)
- M = Production Month (1-9, O, N, D)
- = Pb-Free Microdot

ORDERING INFORMATION

See detailed ordering and shipping information in the package dimensions section on page 10 of this data sheet.

CAT6201, CAV6201B

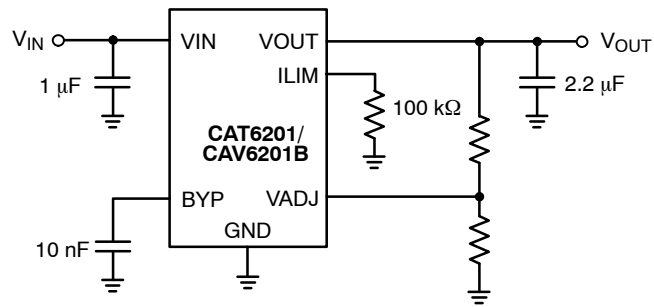

Figure 1. CAT6201/CAV6201B Typical Application

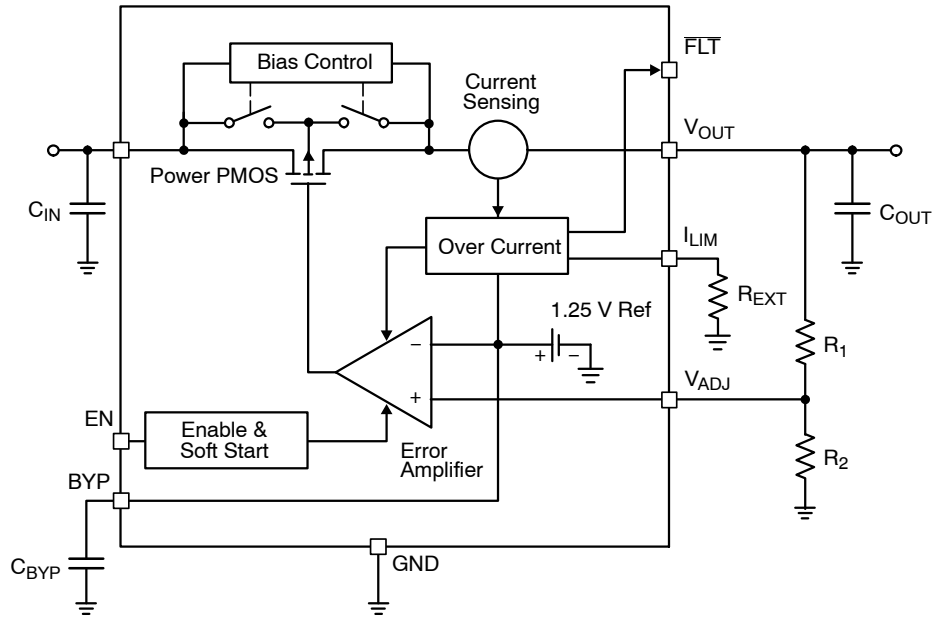

Figure 2. CAT6201/CAV6201B Functional Block Diagram

CAT6201, CAV6201B

Table 1. PIN FUNCTION DESCRIPTION

Pin No.	Pin Name	Description
1	VIN	Supply voltage input
2	FLT	Fault indicator (active low)
3	EN	Enable input (active high)
4	BYP	A capacitor between BYP and GND controls the regulator's turn-on speed and improves PSRR
5	GND	Ground reference
6	ILIM	Current limit control pin
7	VADJ	Output voltage adjustment
8	VOUT	LDO Output Voltage
Pad	-	Backside pad in center of package provides thermal contact for cooling, typically via the PCB ground plane. This pad is electrically active and connected to GND internally. An external Ground connection is not required and the pad may be left floating.

Table 2. ABSOLUTE MAXIMUM RATINGS

Rating	Value	Unit
V _{IN} , V _{OUT} , EN	0 to 16	V
All other pins	-0.3 to +6.0	V
Junction Temperature, T _J	+150	°C
Power Dissipation, P _D	Internally Limited (Note 1)	mW
Storage Temperature Range, T _S	-65 to +150	°C
Lead Temperature (soldering, 5 sec.)	260	°C
ESD Rating (Human Body Model)	1000	V
ESD Rating (Machine Model)	200	V

Stresses exceeding Maximum Ratings may damage the device. Maximum Ratings are stress ratings only. Functional operation above the Recommended Operating Conditions is not implied. Extended exposure to stresses above the Recommended Operating Conditions may affect device reliability.

- The maximum allowable power dissipation at any T_A (ambient temperature) is $P_{Dmax} = (T_{Jmax} - T_A) / \theta_{JA}$. Exceeding the maximum allowable power dissipation will result in excessive die temperature, and the regulator will go into thermal shutdown.

Table 3. RECOMMENDED OPERATING CONDITIONS (Note 2)

Parameter	Range	Unit
V _{IN} , V _{OUT} , EN	3.3 to 13.5	V
All other pins	0 to 6.0	V
Junction Temperature Range, T _J	-40 to +125	°C
Package Thermal Resistance (SOIC), θ_{JA}	235	°C/W
Package Thermal Resistance (TDFN), θ_{JA}	92	°C/W

- The device is not guaranteed to work outside its operating rating.

Pin Function

VIN is the supply pin for both the LDO’s operation and the load the LDO is driving. It is recommended that a 1 μF ceramic bypass capacitor be placed between the VIN pin and ground in close proximity to the device. When using longer connections to the power supply, CIN value can be increased without limit. The operating input voltage range is from 3.3 V to 13.5 V.

FLT is an active low open–drain output indicating one of 3 fault conditions:

1. Input under–voltage: input is below the intended output voltage
2. Over–current. Brief over–current events are masked by a 3 ms time delay.
CAT6201/CAV6201B will limit current anytime the load tries to draw more than the maximum allowed, however reporting of this event will occur only if the event lasts longer than the delay timer. Events terminating before the timer reaches its full count are ignored and the timer is reset.
3. Over–temperature shutdown has occurred.

EN is an active HIGH logic level input for switching the regulator’s output between ON and OFF. A weak internal pull down assures that if EN pin is left open, the circuit is disabled.

BYP controls the soft–start feature for the regulator. When large capacitive loads are present at the regulator’s output, enabling the regulator will produce large current surges on the VIN supply line. To reduce these surges the regulator can be turned on gently by connecting a capacitor between the BYP pin and ground. The larger the capacitance value the more slowly VOUT approaches its programmed value. The table below gives a list of common capacitor values and their resulting turn–on times. If the soft–start feature is not desired, this pin should be left floating.

Capacitance [nF]	tON [ms]
0	0.2
10	1
100	10

GND is the ground reference for the LDO in the TDFN package, center metal pad is internally connected to GND. If electrical contact is made with this pad, it should be to GND and/or the ground plane of the PCB. Connection to the ground plane enhances thermal conductivity drawing heat out of the package and into the surrounding PCB.

ILIM stands for Current Limit and is the control input for setting the point at which the current limit is invoked. ILIM is defined as the current at which VOUT is still within 80% of its nominal value and should not be confused with ISC, the

short circuit current, measured at VOUT = 0 V, which is typically 100 mA greater than ILIM.

A resistor REXT placed between ILIM and GND selects the trip current according to a formula:

$$I_{LIM} = I_{LIM0} + \frac{\text{Current_Limit_Factor}(CLF)}{R_{EXT}} \quad (\text{eq. 1})$$

ILIM0 is the built–in minimum current limit (typically 150 mA), and CLF is a numerical value (typical 30,000 Volts) which relates the allowable load current to a resistance value. The value of this resistor is determined by the following equation:

$$R_{EXT}(\Omega) = \frac{CLF(V)}{I_{LIM}(A) - I_{LIM0}(A)} \quad (\text{eq. 2})$$

It is recommended that ILIM be set to at least 50% higher than the maximum intended continuous IOUT.

Example: Set ILIMIT = 600 mA

$$R_{EXT}(\Omega) = \frac{30,000 V}{0.6 A - 0.15 A} = 68 K\Omega \quad (\text{eq. 3})$$

VADJ is the output voltage control pin. A resistor divider placed between VOUT and GND whose center point connects to VADJ sets the LDO regulator’s output voltage. Typical VADJ value is 1.25 V. The current through the resistor divider can be anywhere between 10 μA and 1 mA. The higher this current is, the lower the noise.

For best performance R1 and R2 should have similar temperature coefficients, otherwise output voltage accuracy will be compromised.

$$V_{OUT} = V_{ADJ} \left(1 + \frac{R_1}{R_2} \right) \quad (\text{eq. 4})$$

VOUT is the LDO regulator output. A small 2.2 μF ceramic bypass capacitor is required between VOUT and ground. For better transient response, its value can be increased to 4.7 μF. This capacitor should be located near the device.

VOUT is protected against short circuits and over–temp operation by internal circuitry. In the event of an over–current, the LDO behaves like a current source, limiting current at the output. The maximum current allowed is set by REXT, the resistor between ILIM and GND. If the load attempts to draw more than the allowed current, VOUT and IOUT decrease together and thus limit the total power delivered.

VOUT is protected against the application of voltages greater than VIN. For example, in automotive applications, if CAT6201/CAV6201B is powering a remote load and damage occurs to a wiring harness shorting a powered line, Battery + for instance, to VOUT, CAT6201/CAV6201B will not be damaged by this higher voltage being applied to VOUT.

CAT6201, CAV6201B

Table 4. ELECTRICAL CHARACTERISTICS

($V_{IN} = V_{OUT} + 1\text{ V}$, $V_{EN} = \text{High}$, $I_{OUT} = 1\text{ mA}$, $C_{IN} = 1\text{ }\mu\text{F}$, $C_{OUT} = 2.2\text{ }\mu\text{F}$, $R_{EXT} = 68\text{ k}\Omega$, ambient temperature of 25°C (over recommended operating conditions unless specified otherwise). **Bold numbers** apply for the entire junction temperature range.)

Symbol	Parameter	Conditions	Min	Typ	Max	Unit
V_{IN}	Input Voltage		3.3		13.5	V
V_{OUT}	Output Voltage		V_{ADJ}		12.5	
V_{ADJ}	ADJ Voltage		1.232	1.250	1.268	V
I_{ADJ}	ADJ Input Current			0.5	2.0	μA
TC_{OUT}	Output Voltage Temp. Coefficient	$I_{OUT} = 10\text{ mA}$		100		ppm/ $^\circ\text{C}$
V_{R-LINE}	Line Regulation	$V_{OUT} + 1\text{ V} < V_{IN} < 13.5\text{ V}$	-0.2	± 0.1	+0.2	%/ V
			-0.4		+0.4	
V_{R-LOAD}	Load Regulation	$I_{OUT} = 1\text{ mA to }300\text{ mA}$		0.7	2	%
V_{DROP}	Dropout Voltage (Note 3)	$I_{OUT} = 300\text{ mA}$		250	350	mV
I_{GND}	Ground Current	$I_{OUT} = 0\text{ mA}$		100	150	μA
		$I_{OUT} = 300\text{ mA}$		160	300	
I_{GND-SD}	Shutdown Ground Current	$V_{EN} < 0.4\text{ V}$		0.5	2	μA
PSRR	Power Supply Rejection Ratio	$f = 1\text{ kHz}$, $C_{BYP} = 10\text{ nF}$		62		dB
		$f = 20\text{ kHz}$, $C_{BYP} = 10\text{ nF}$		52		
T_{ON}	Turn-On Time	$C_{BYP} = 10\text{ nF}$ $V_{OUT} = 0\% - 100\%$		700		μs
I_{SC}	Output short circuit current	$V_{OUT} < 0.8\text{ V}$ $R_{EXT} = 68\text{ K}$	500	650	800	mA
		$V_{OUT} < 0.8\text{ V}$ $I_{LIM} = \text{OPEN}$		200		
I_{LIM}	Output current limit	$V_{OUT} = 80\%$ of V_{OUT} measured at a load of 1 mA $R_{EXT} = 68\text{ K}$	400	450	600	mA
		$V_{OUT} = 80\%$ of V_{OUT} measured at a load of 1 mA $I_{LIM} = \text{OPEN}$	120	150	180	
CLF	Current Limit Factor	$V_{OUT} < 0.8\text{ V}$	24	30	36	KV
t_{FD}	Fault Delay		1.5	3	6	ms
$V_{IN-UVLO}$	Under voltage lockout threshold		2.85	3.1	3.25	V
ESR	R_{OUT} equivalent series resistance		5		500	$\text{m}\Omega$

ENABLE INPUT

V_{HI}	Logic High Level	$V_{IN} = 3.3\text{ to }13.5\text{ V}$	2			V
V_{LO}	Logic Low Level	$V_{IN} = 3.3\text{ to }13.5\text{ V}$			0.4	V
I_{EN}	Enable Input Current	$V_{EN} = 0.4\text{ V}$		0.15	1	μA
		$V_{EN} = V_{IN}$		3	5	

THERMAL PROTECTION

T_{SD}	Thermal Shutdown			140		$^\circ\text{C}$
T_{HYS}	Thermal Hysteresis			10		$^\circ\text{C}$

3. Dropout voltage is defined as the input-to-output differential at which the output voltage drops 2% below its nominal value. During test, the input voltage stays always above the minimum 3.3 V. The given values are for $V_{OUT} = 7.5\text{ V}$.

CAT6201, CAV6201B

TYPICAL CHARACTERISTICS (shown for 7.5 V output)

($V_{IN} = 8.5\text{ V}$, $R_1 = 5.1\text{ k}\Omega$, $R_2 = 1\text{ k}\Omega$, $C_{IN} = 1\text{ }\mu\text{F}$, $C_{OUT} = 2.2\text{ }\mu\text{F}$, $C_{BYP} = 10\text{ nF}$, $R_{EXT} = 68\text{ k}\Omega$, FLT not connected, $T_A = 25^\circ\text{C}$ unless otherwise specified.)

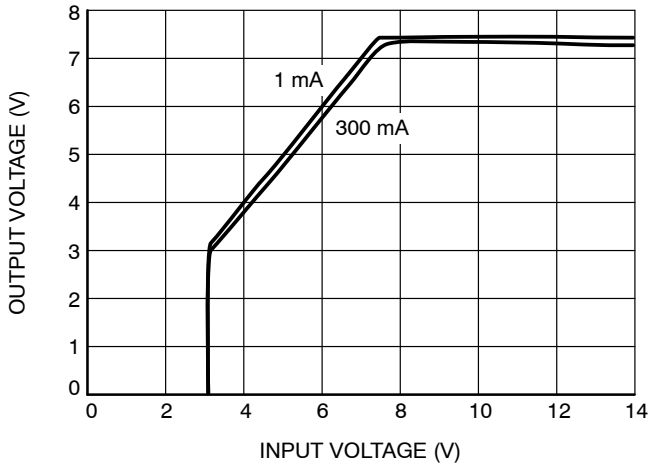

Figure 3. Dropout Characteristics

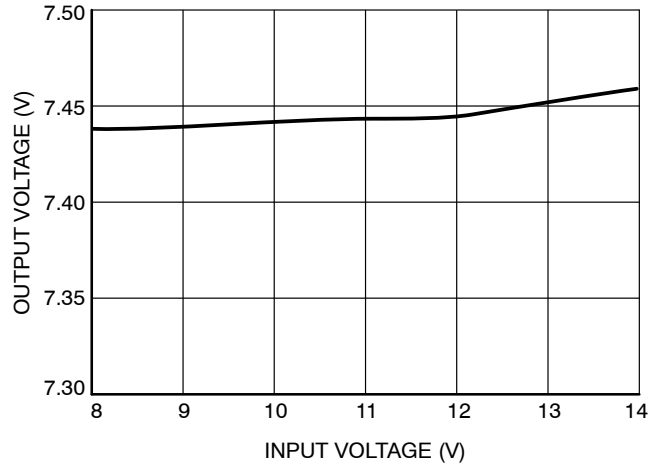

Figure 4. Line Regulation

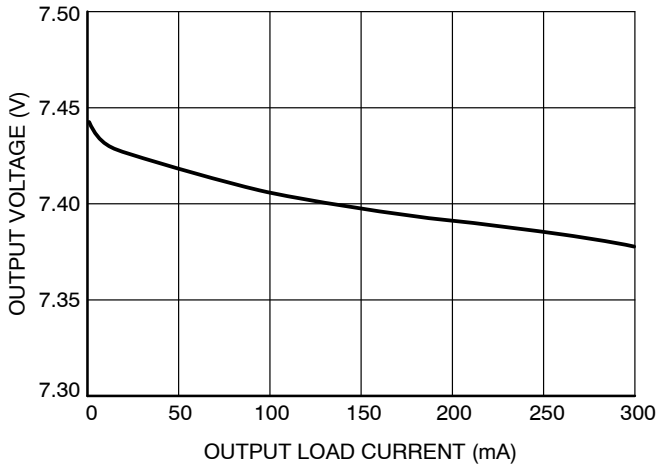

Figure 5. Load Regulation

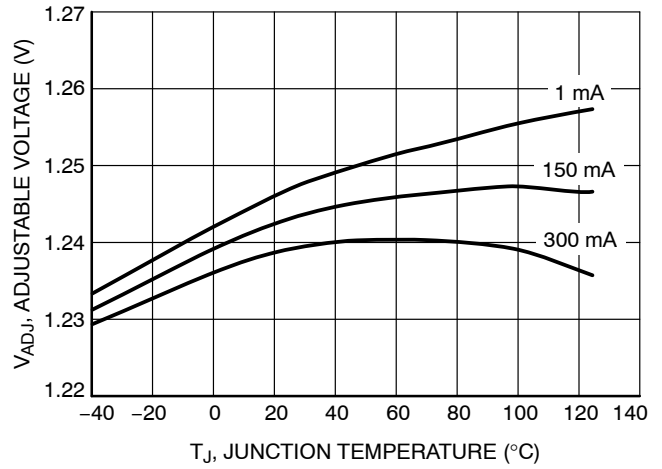

Figure 6. Adjustable Voltage vs. Temperature

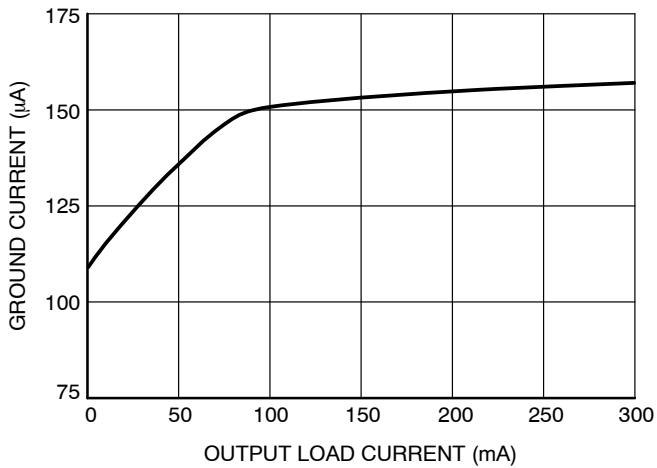

Figure 7. Ground Current vs. Load Current

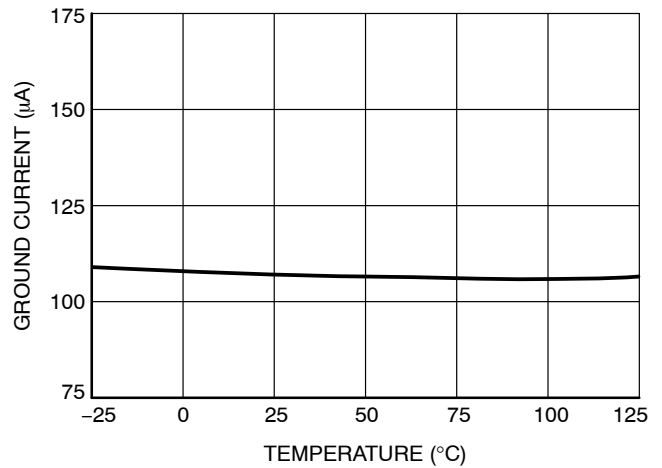

Figure 8. Ground Current vs. Temperature

CAT6201, CAV6201B

TYPICAL CHARACTERISTICS (shown for 7.5 V output)

($V_{IN} = 8.5\text{ V}$, $R_1 = 5.1\text{ k}\Omega$, $R_2 = 1\text{ k}\Omega$, $C_{IN} = 1\text{ }\mu\text{F}$, $C_{OUT} = 2.2\text{ }\mu\text{F}$, $C_{BYP} = 10\text{ nF}$, $R_{EXT} = 68\text{ k}\Omega$, FLT not connected, $T_A = 25^\circ\text{C}$ unless otherwise specified.)

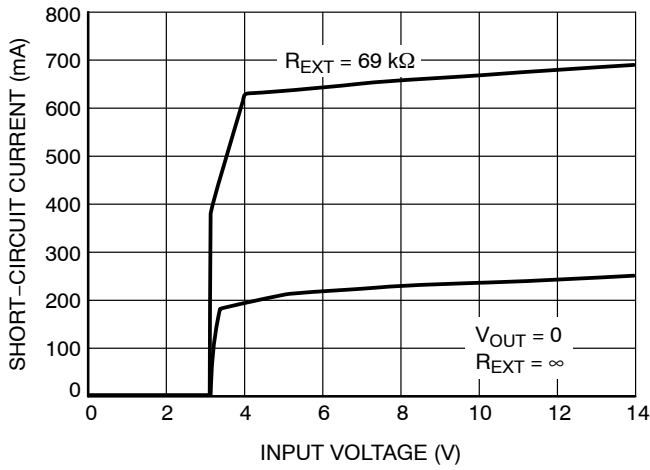

Figure 9. Output Short-circuit Current vs. Input Voltage

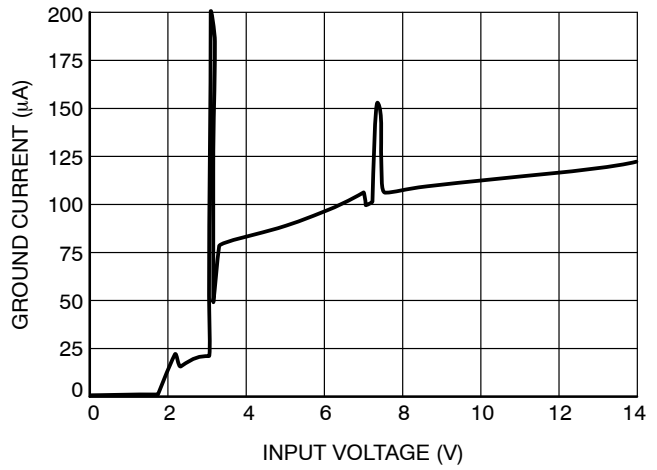

Figure 10. Ground Current vs. Input Voltage

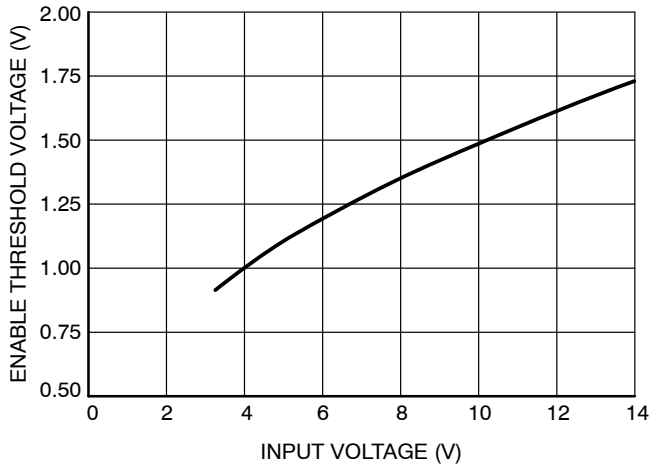

Figure 11. Enable Threshold vs. Input Voltage

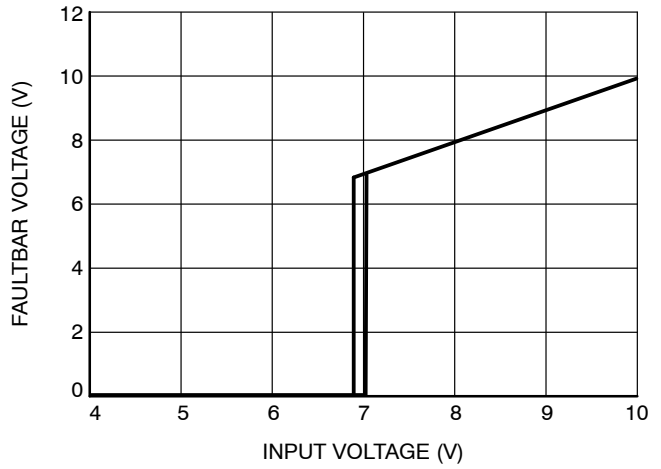

Figure 12. Fault Bar Voltage vs. Input Voltage

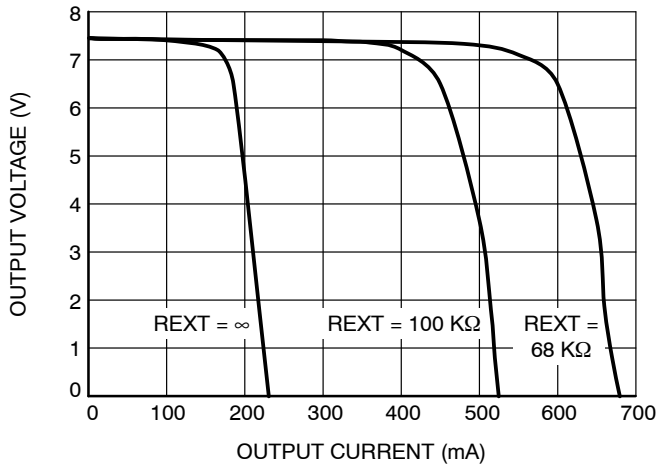

Figure 13. Output Voltage vs. Load Current

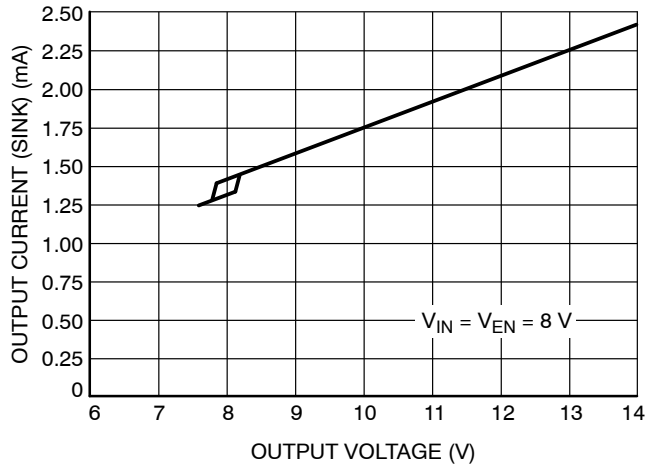

Figure 14. Output Current (Sink) vs. Output Voltage

CAT6201, CAV6201B

TYPICAL CHARACTERISTICS (shown for 7.5 V output)

($V_{IN} = 8.5\text{ V}$, $R_1 = 5.1\text{ k}\Omega$, $R_2 = 1\text{ k}\Omega$, $C_{IN} = 1\text{ }\mu\text{F}$, $C_{OUT} = 2.2\text{ }\mu\text{F}$, $C_{BYP} = 10\text{ nF}$, $R_{EXT} = 68\text{ k}\Omega$,
 $T_A = 25^\circ\text{C}$ unless otherwise specified. All transient characteristics are generated using the evaluation board CAT6201EVAL1.)

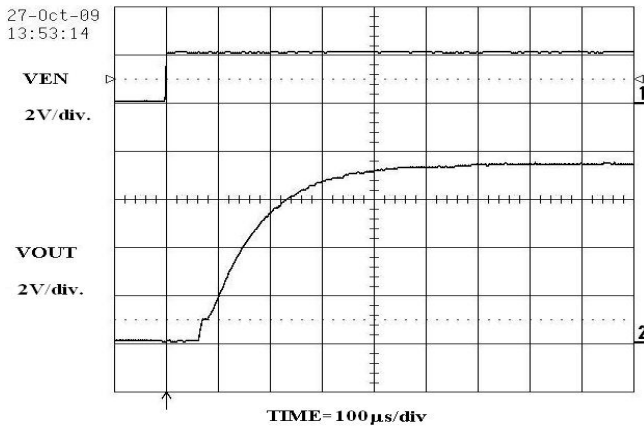

Figure 15. Enable Turn-On (No Load)

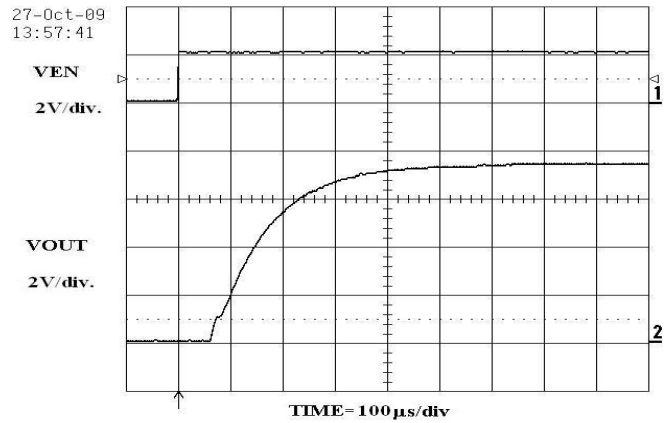

Figure 16. Enable Turn-On (22 Ω Load)

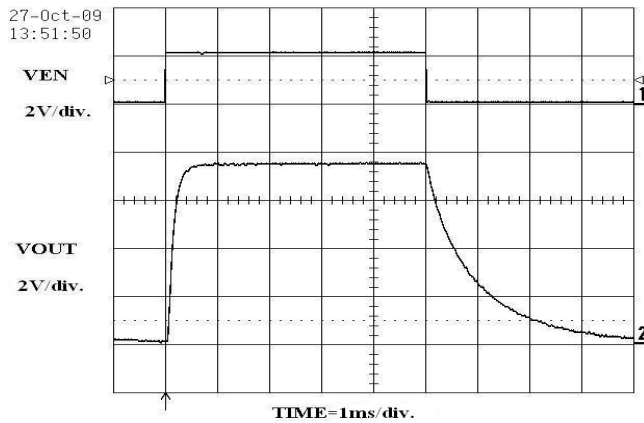

Figure 17. Enable Operation (No Load)

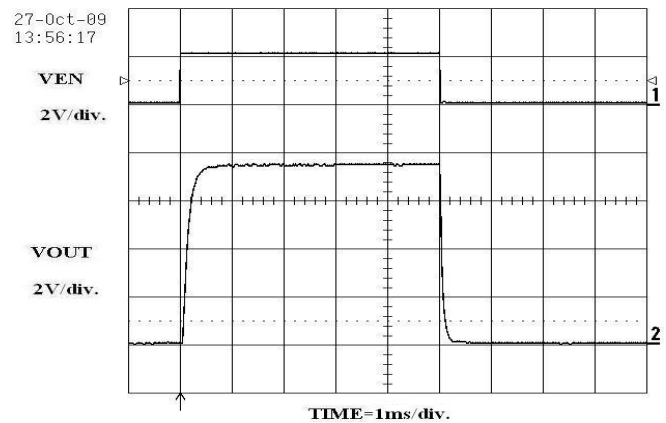

Figure 18. Enable Operation (22 Ω Load)

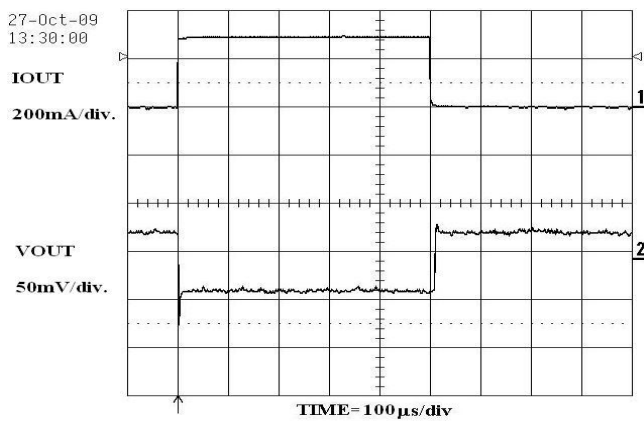

Figure 19. Load Transient Response
(1 mA to 330 mA)

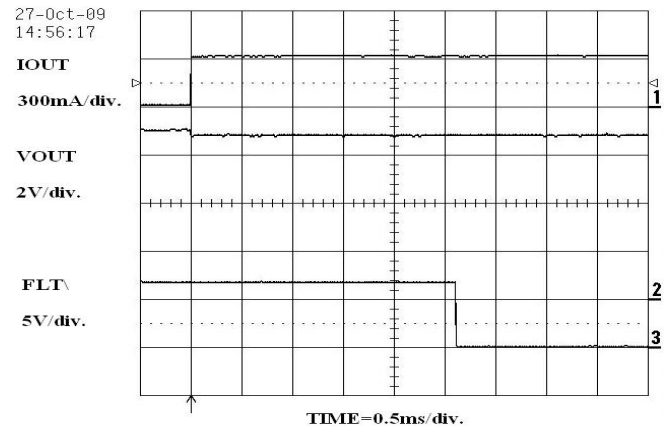

Figure 20. Fault Operation
($V_{IN} = 7\text{ V}$ and 22 Ω Load)

CAT6201, CAV6201B

ORDERING INFORMATION

Device Order Number	Specific Device Marking	Package Type	Lead Finish	Shipping (Note 5)
CAT6201VP2-GT3	HKB	TDFN-8	NiPdAu	3,000 / Tape & Reel
CAV6201BVP2-GT3	HKB	TDFN-8	NiPdAu	3,000 / Tape & Reel

4. For additional package and temperature options, please contact your nearest ON Semiconductor Sales office.
5. For information on tape and reel specifications, including part orientation and tape sizes, please refer to our Tape and Reel Packaging Specifications Brochure, BRD8011/D.
6. For detailed information and a breakdown of device nomenclature and numbering systems, please see the ON Semiconductor Device Nomenclature document, TND310/D, available at www.onsemi.com.

MECHANICAL CASE OUTLINE

PACKAGE DIMENSIONS

ON Semiconductor®



SCALE 2:1

TDFN8, 2x3, 0.5P
CASE 511AK
ISSUE B

DATE 18 MAR 2015

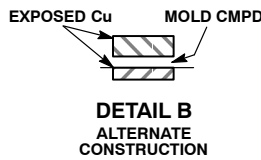
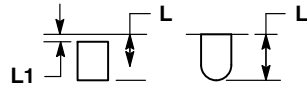
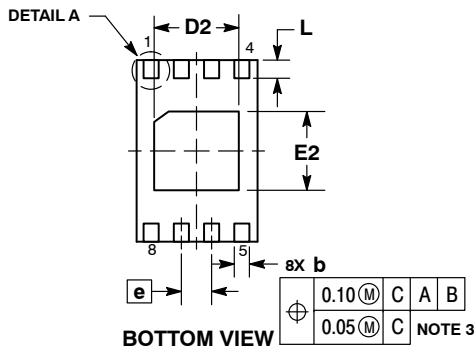
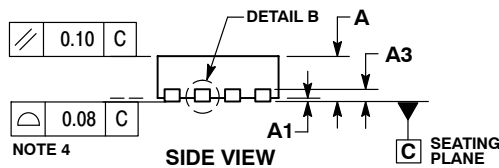
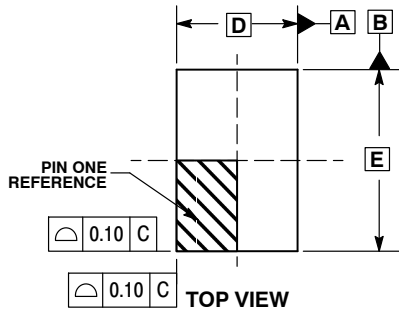

NOTES:

1. DIMENSIONING AND TOLERANCING PER ASME Y14.5M, 1994.
2. CONTROLLING DIMENSION: MILLIMETERS.
3. DIMENSION b APPLIES TO PLATED TERMINAL AND IS MEASURED BETWEEN 0.15 AND 0.25MM FROM THE TERMINAL TIP.
4. COPLANARITY APPLIES TO THE EXPOSED PAD AS WELL AS THE TERMINALS.

DIM	MILLIMETERS	
	MIN	MAX
A	0.70	0.80
A1	0.00	0.05
A3	0.20 REF	
b	0.20	0.30
D	2.00 BSC	
D2	1.30	1.50
E	3.00 BSC	
E2	1.20	1.40
e	0.50 BSC	
L	0.20	0.40
L1	---	0.15

GENERIC MARKING DIAGRAM*

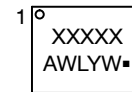

- XXXXX = Specific Device Code
- A = Assembly Location
- WL = Wafer Lot
- Y = Year
- W = Work Week
- = Pb-Free Package

*This information is generic. Please refer to device data sheet for actual part marking. Pb-Free indicator, "G" or microdot "▪", may or may not be present.

RECOMMENDED SOLDERING FOOTPRINT*

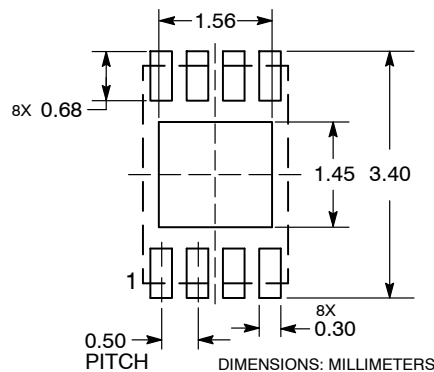

*For additional information on our Pb-Free strategy and soldering details, please download the ON Semiconductor Soldering and Mounting Techniques Reference Manual, SOLDERRM/D.

DOCUMENT NUMBER:	98AON34336E	Electronic versions are uncontrolled except when accessed directly from the Document Repository. Printed versions are uncontrolled except when stamped "CONTROLLED COPY" in red.
DESCRIPTION:	TDFN8, 2X3, 0.5P	PAGE 1 OF 1

ON Semiconductor and ON are trademarks of Semiconductor Components Industries, LLC dba ON Semiconductor or its subsidiaries in the United States and/or other countries. ON Semiconductor reserves the right to make changes without further notice to any products herein. ON Semiconductor makes no warranty, representation or guarantee regarding the suitability of its products for any particular purpose, nor does ON Semiconductor assume any liability arising out of the application or use of any product or circuit, and specifically disclaims any and all liability, including without limitation special, consequential or incidental damages. ON Semiconductor does not convey any license under its patent rights nor the rights of others.

onsemi, **Onsemi**, and other names, marks, and brands are registered and/or common law trademarks of Semiconductor Components Industries, LLC dba "**onsemi**" or its affiliates and/or subsidiaries in the United States and/or other countries. **onsemi** owns the rights to a number of patents, trademarks, copyrights, trade secrets, and other intellectual property. A listing of **onsemi**'s product/patent coverage may be accessed at www.onsemi.com/site/pdf/Patent-Marking.pdf. **onsemi** reserves the right to make changes at any time to any products or information herein, without notice. The information herein is provided "as-is" and **onsemi** makes no warranty, representation or guarantee regarding the accuracy of the information, product features, availability, functionality, or suitability of its products for any particular purpose, nor does **onsemi** assume any liability arising out of the application or use of any product or circuit, and specifically disclaims any and all liability, including without limitation special, consequential or incidental damages. Buyer is responsible for its products and applications using **onsemi** products, including compliance with all laws, regulations and safety requirements or standards, regardless of any support or applications information provided by **onsemi**. "Typical" parameters which may be provided in **onsemi** data sheets and/or specifications can and do vary in different applications and actual performance may vary over time. All operating parameters, including "Typicals" must be validated for each customer application by customer's technical experts. **onsemi** does not convey any license under any of its intellectual property rights nor the rights of others. **onsemi** products are not designed, intended, or authorized for use as a critical component in life support systems or any FDA Class 3 medical devices or medical devices with a same or similar classification in a foreign jurisdiction or any devices intended for implantation in the human body. Should Buyer purchase or use **onsemi** products for any such unintended or unauthorized application, Buyer shall indemnify and hold **onsemi** and its officers, employees, subsidiaries, affiliates, and distributors harmless against all claims, costs, damages, and expenses, and reasonable attorney fees arising out of, directly or indirectly, any claim of personal injury or death associated with such unintended or unauthorized use, even if such claim alleges that **onsemi** was negligent regarding the design or manufacture of the part. **onsemi** is an Equal Opportunity/Affirmative Action Employer. This literature is subject to all applicable copyright laws and is not for resale in any manner.

PUBLICATION ORDERING INFORMATION

LITERATURE FULFILLMENT:

Email Requests to: orderlit@onsemi.com

onsemi Website: www.onsemi.com

TECHNICAL SUPPORT

North American Technical Support:

Voice Mail: 1 800-282-9855 Toll Free USA/Canada

Phone: 011 421 33 790 2910

Europe, Middle East and Africa Technical Support:

Phone: 00421 33 790 2910

For additional information, please contact your local Sales Representative

X-ON Electronics

Largest Supplier of Electrical and Electronic Components

Click to view similar products for [LDO Voltage Controllers](#) category:

Click to view products by [ON Semiconductor](#) manufacturer:

Other Similar products are found below :

[CAT6201VP2-GT3](#) [AS1360-18-T](#) [MIC5156-5.0YN](#) [MIC5191YML-T5](#) [MIC5191YMM](#) [LT3150CGN#PBF](#) [MAX1649CPA+](#) [MIC5158YM](#)
[MIC5157YM](#) [MIC5158YM TR](#) [MAX8563EEE+](#) [MAX8564AEUB+](#) [MAX8564EUB+](#) [MIC5156YN](#) [MIC5158YN](#) [MIC5190YMM](#)
[MIC5156-5.0YM](#) [MIC5156YM](#) [MIC5156-3.3YN](#) [MIC5157YN](#) [MIC5159-1.8YM6-TR](#) [MIC5159YM6 TR](#) [NCV33269DR2G](#)
[MAX1651ESA+](#) [MAX1651CSA+](#) [MAX1649CSA+](#) [MAX1649ESA+](#) [MAX1649ESA+T](#) [RN5RF33BA-TR-FE](#) [BD00IC0WEFJ-E2](#)
[BD10IC0WEFJ-E2](#) [BD12IA5WEFJ-E2](#) [BD15IA5WEFJ-E2](#) [BD18GC0WEFJ-E2](#) [BD18HC5WEFJ-E2](#) [BD18IC0WEFJ-E2](#) [BD18IC0WHFV-](#)
[GTR](#) [BD30GC0WEFJ-E2](#) [BD30IA5WEFJ-E2](#) [BD33GA3WEFJ-E2](#) [BD33IA5WEFJ-E2](#) [BD33IC0WEFJ-E2](#) [BD50GA3WEFJ-E2](#)
[BD50GA5WEFJ-E2](#) [BD50HC5WEFJ-E2](#) [BD60GA3WEFJ-E2](#) [BD60GA5WEFJ-E2](#) [BD60GC0WEFJ-E2](#) [BD60HC5WEFJ-E2](#)
[BD70GA3WEFJ-E2](#)