



Is Now Part of



ON Semiconductor®

To learn more about ON Semiconductor, please visit our website at
www.onsemi.com

Please note: As part of the Fairchild Semiconductor integration, some of the Fairchild orderable part numbers will need to change in order to meet ON Semiconductor's system requirements. Since the ON Semiconductor product management systems do not have the ability to manage part nomenclature that utilizes an underscore (_), the underscore (_) in the Fairchild part numbers will be changed to a dash (-). This document may contain device numbers with an underscore (_). Please check the ON Semiconductor website to verify the updated device numbers. The most current and up-to-date ordering information can be found at www.onsemi.com. Please email any questions regarding the system integration to Fairchild_questions@onsemi.com.

ON Semiconductor and the ON Semiconductor logo are trademarks of Semiconductor Components Industries, LLC dba ON Semiconductor or its subsidiaries in the United States and/or other countries. ON Semiconductor owns the rights to a number of patents, trademarks, copyrights, trade secrets, and other intellectual property. A listing of ON Semiconductor's product/patent coverage may be accessed at www.onsemi.com/site/pdf/Patent-Marking.pdf. ON Semiconductor reserves the right to make changes without further notice to any products herein. ON Semiconductor makes no warranty, representation or guarantee regarding the suitability of its products for any particular purpose, nor does ON Semiconductor assume any liability arising out of the application or use of any product or circuit, and specifically disclaims any and all liability, including without limitation special, consequential or incidental damages. Buyer is responsible for its products and applications using ON Semiconductor products, including compliance with all laws, regulations and safety requirements or standards, regardless of any support or applications information provided by ON Semiconductor. "Typical" parameters which may be provided in ON Semiconductor data sheets and/or specifications can and do vary in different applications and actual performance may vary over time. All operating parameters, including "Typicals" must be validated for each customer application by customer's technical experts. ON Semiconductor does not convey any license under its patent rights nor the rights of others. ON Semiconductor products are not designed, intended, or authorized for use as a critical component in life support systems or any FDA Class 3 medical devices or medical devices with a same or similar classification in a foreign jurisdiction or any devices intended for implantation in the human body. Should Buyer purchase or use ON Semiconductor products for any such unintended or unauthorized application, Buyer shall indemnify and hold ON Semiconductor and its officers, employees, subsidiaries, affiliates, and distributors harmless against all claims, costs, damages, and expenses, and reasonable attorney fees arising out of, directly or indirectly, any claim of personal injury or death associated with such unintended or unauthorized use, even if such claim alleges that ON Semiconductor was negligent regarding the design or manufacture of the part. ON Semiconductor is an Equal Opportunity/Affirmative Action Employer. This literature is subject to all applicable copyright laws and is not for resale in any manner.



November 2014



D44H8 / NZT44H8 NPN Power Amplifier

Features

- This device is designed for power amplifier, regulator and switching circuits where speed is important.
- Sourced from process 4Q.

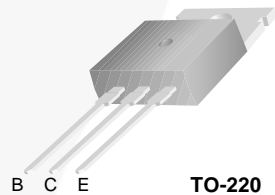

Figure 1. D44H8 Device Package

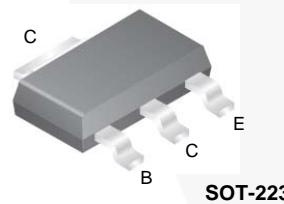

Figure 2. NZT44H8 Device Package

Ordering Information

Part Number	Marking	Package	Packing Method
D44H8	D44H8	TO-220 3L	Rail
NZT44H8	44H8	SOT-223 4L	Tape and Reel

Absolute Maximum Ratings^{(1),(2)}

Stresses exceeding the absolute maximum ratings may damage the device. The device may not function or be operable above the recommended operating conditions and stressing the parts to these levels is not recommended. In addition, extended exposure to stresses above the recommended operating conditions may affect device reliability. The absolute maximum ratings are stress ratings only. Values are at $T_A = 25^\circ\text{C}$ unless otherwise noted.

Symbol	Parameter	Value	Unit
V_{CEO}	Collector-Emitter Voltage	60	V
I_C	Collector Current - Continuous	8.0	A
T_J, T_{STG}	Operating and Storage Junction Temperature Range	-55 to +150	$^\circ\text{C}$

Notes:

1. These ratings are based on a maximum junction temperature of 150°C .
2. These are steady-state limits. Fairchild Semiconductor should be consulted on applications involving pulsed or low-duty-cycle operations.

Thermal Characteristics⁽³⁾

Values are at $T_A = 25^\circ\text{C}$ unless otherwise noted.

Symbol	Parameter	Max.		Unit
		D44H8	NZT44H8	
P_D	Total Device Dissipation	60	1.5	W
	Derate Above 25°C	480	12	mW/ $^\circ\text{C}$
$R_{\theta\text{JC}}$	Thermal Resistance, Junction-to-Case	2.1		$^\circ\text{C}/\text{W}$
$R_{\theta\text{JA}}$	Thermal Resistance, Junction-to-Ambient	62.5	83.3	$^\circ\text{C}/\text{W}$

Note:

3. PCB size: FR-4, 76 mm x 114 mm x 1.57 mm (3.0 inch x 4.5 inch x 0.062 inch) with minimum land pattern size.

Electrical Characteristics

Values are at $T_A = 25^\circ\text{C}$ unless otherwise noted.

Symbol	Parameter	Conditions	Min.	Max.	Unit
$V_{(\text{BR})\text{CEO}}$	Collector-Emitter Breakdown Voltage	$I_C = 100 \text{ mA}, I_B = 0$	60		V
I_{CBO}	Collector-Base Cut-Off Current	$V_{\text{CB}} = 60 \text{ V}, I_E = 0$		10	μA
I_{EBO}	Emitter-Base Cut-Off Current	$V_{\text{EB}} = 5 \text{ V}, I_C = 0$		100	μA
h_{FE}	DC Current Gain	$V_{\text{CE}} = 1 \text{ V}, I_C = 2 \text{ A}$	60		
		$V_{\text{CE}} = 1 \text{ V}, I_C = 4 \text{ A}$	40		
$V_{\text{CE(sat)}}$	Collector-Emitter Saturation Voltage	$I_C = 8 \text{ A}, I_B = 0.4 \text{ A}$		1.0	V
$V_{\text{BE(sat)}}$	Base-Emitter Saturation Voltage	$I_C = 8 \text{ A}, I_B = 0.8 \text{ A}$		1.5	V
$V_{\text{BE(on)}}$	Base-Emitter On Voltage	$V_{\text{CE}} = 2 \text{ V}, I_C = 10 \text{ mA}$	0.52	0.65	V
f_T	Current Gain-Bandwidth Product	$I_C = 500 \text{ mA}, V_{\text{CE}} = 10 \text{ V}$	50		MHz

Typical Performance Characteristics

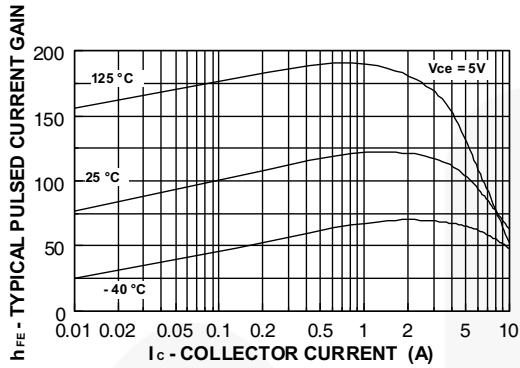

Figure 3. Typical Pulsed Current Gain vs. Collector Current

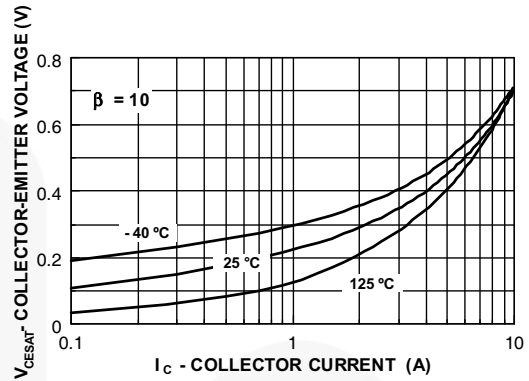

Figure 4. Collector-Emitter Saturation Voltage vs. Collector Current

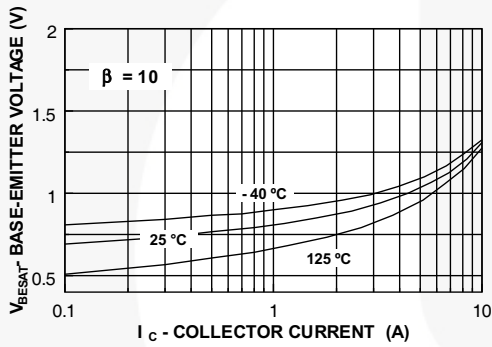

Figure 5. Base-Emitter Saturation Voltage vs. Collector Current

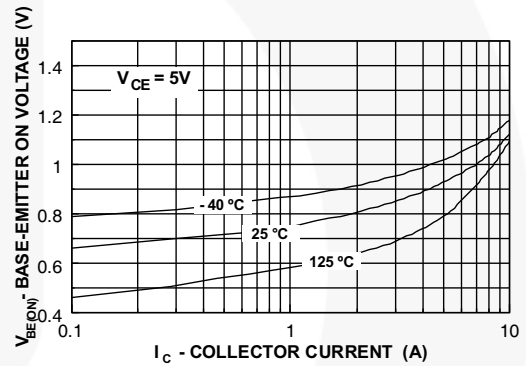

Figure 6. Base-Emitter On Voltage vs. Collector Current

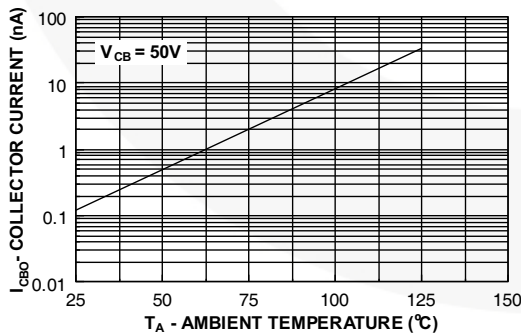

Figure 7. Current Cut-Off Current vs. Ambient Temperature

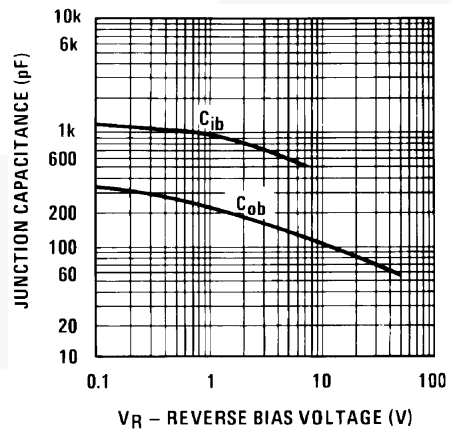

Figure 8. Junction Capacitance vs. Reverse Bias Voltage

Typical Performance Characteristics (Continued)

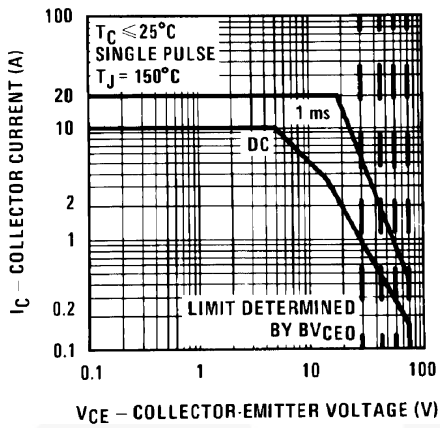

Figure 9. Safe Operating Area TO-220

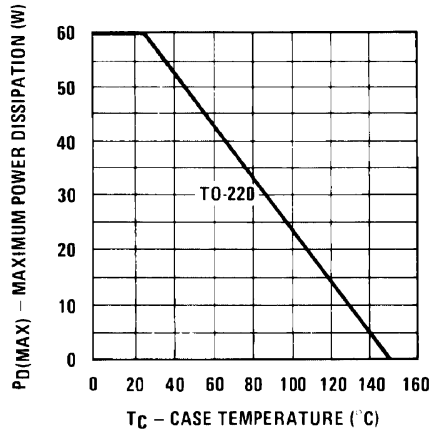

Figure 10. Maximum Power Dissipation vs. Case Temperature

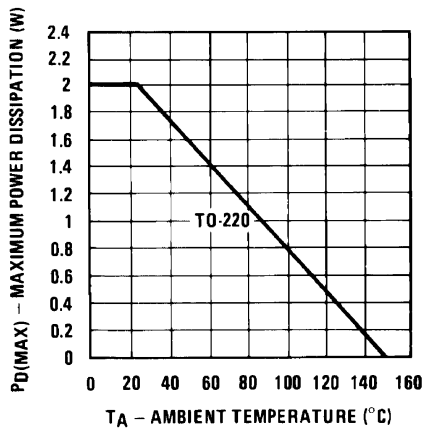

Figure 11. Maximum Power Dissipation vs. Ambient Temperature

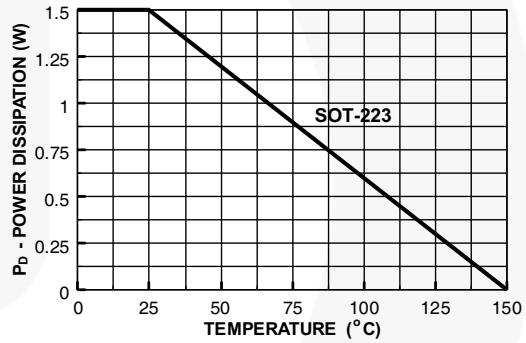

Figure 12. Power Dissipation vs. Ambient Temperature

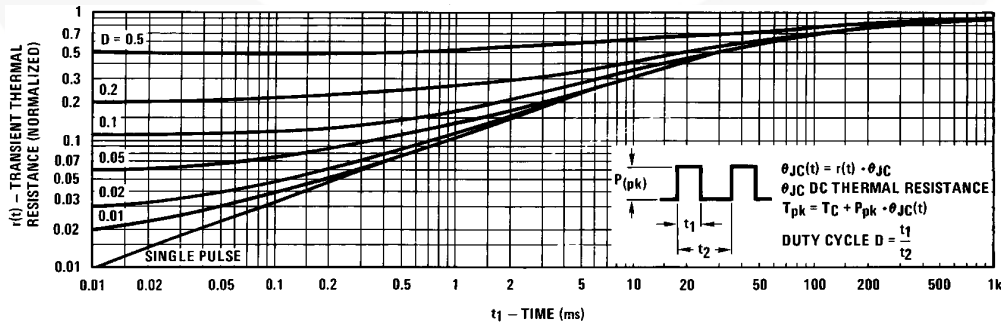
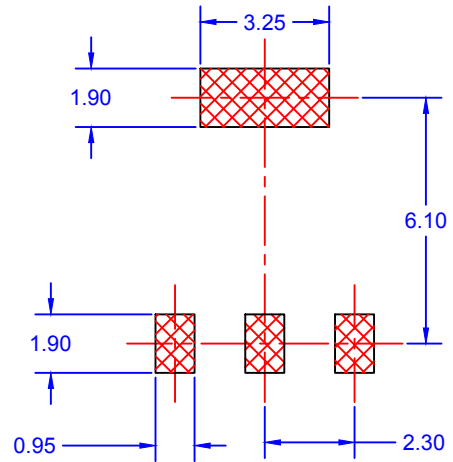
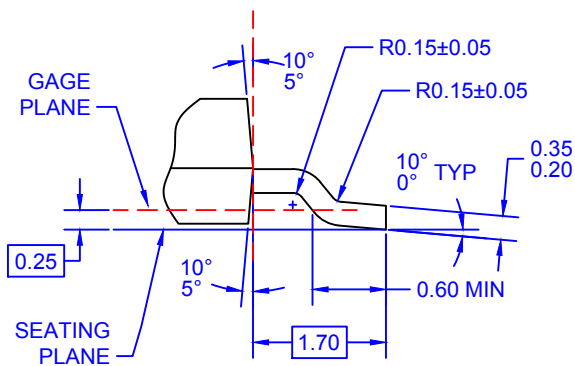
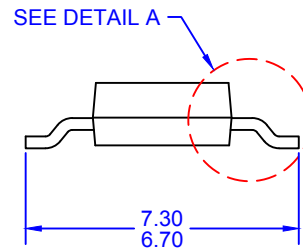
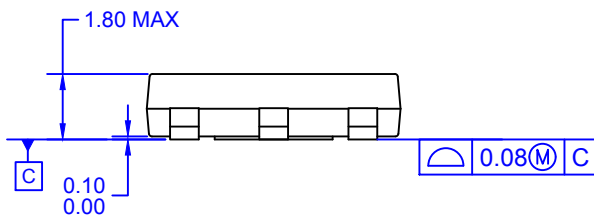

Figure 13. Thermal Response in TO-220 Package



LAND PATTERN RECOMMENDATION



DETAIL A
SCALE: 2:1

- NOTES: UNLESS OTHERWISE SPECIFIED
 A) DRAWING BASED ON JEDEC REGISTRATION TO-261C, VARIATION AA.
 B) ALL DIMENSIONS ARE IN MILLIMETERS.
 C) DIMENSIONS DO NOT INCLUDE BURRS OR MOLD FLASH. MOLD FLASH OR BURRS DOES NOT EXCEED 0.10MM.
 D) DIMENSIONING AND TOLERANCING PER ASME Y14.5M-2009.
 E) LANDPATTERN NAME: SOT230P700X180-4BN
 F) DRAWING FILENAME: MKT-MA04AREV3



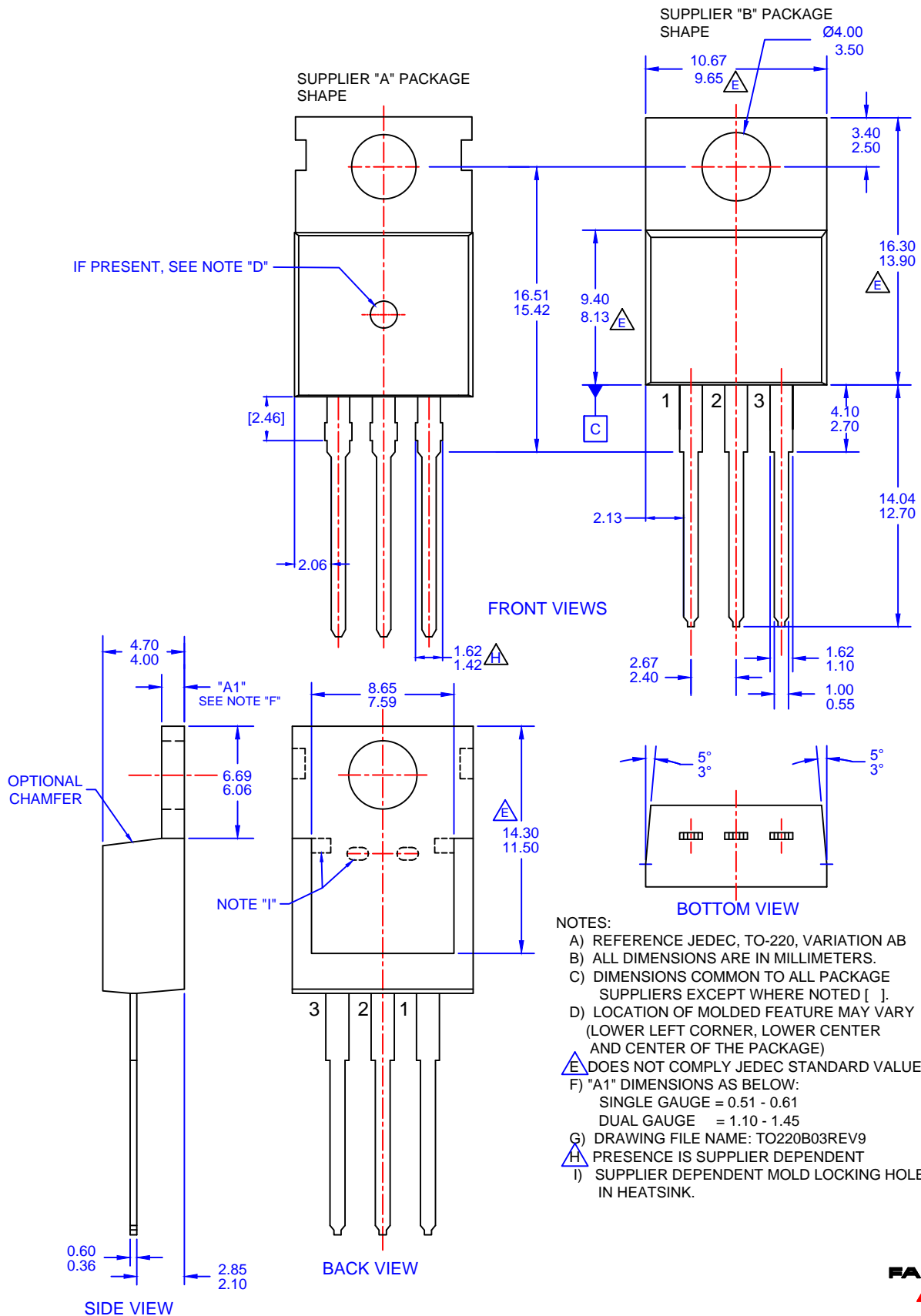

- NOTES:
- A) REFERENCE JEDEC, TO-220, VARIATION AB
 - B) ALL DIMENSIONS ARE IN MILLIMETERS.
 - C) DIMENSIONS COMMON TO ALL PACKAGE SUPPLIERS EXCEPT WHERE NOTED [].
 - D) LOCATION OF MOLDED FEATURE MAY VARY (LOWER LEFT CORNER, LOWER CENTER AND CENTER OF THE PACKAGE)
 - E) DOES NOT COMPLY JEDEC STANDARD VALUE.
 - F) "A1" DIMENSIONS AS BELOW:
 SINGLE GAUGE = 0.51 - 0.61
 DUAL GAUGE = 1.10 - 1.45
 - G) DRAWING FILE NAME: TO220B03REV9
 - H) PRESENCE IS SUPPLIER DEPENDENT
 - I) SUPPLIER DEPENDENT MOLD LOCKING HOLES IN HEATSINK.

ON Semiconductor and  are trademarks of Semiconductor Components Industries, LLC dba ON Semiconductor or its subsidiaries in the United States and/or other countries. ON Semiconductor owns the rights to a number of patents, trademarks, copyrights, trade secrets, and other intellectual property. A listing of ON Semiconductor's product/patent coverage may be accessed at www.onsemi.com/site/pdf/Patent-Marking.pdf. ON Semiconductor reserves the right to make changes without further notice to any products herein. ON Semiconductor makes no warranty, representation or guarantee regarding the suitability of its products for any particular purpose, nor does ON Semiconductor assume any liability arising out of the application or use of any product or circuit, and specifically disclaims any and all liability, including without limitation special, consequential or incidental damages. Buyer is responsible for its products and applications using ON Semiconductor products, including compliance with all laws, regulations and safety requirements or standards, regardless of any support or applications information provided by ON Semiconductor. "Typical" parameters which may be provided in ON Semiconductor data sheets and/or specifications can and do vary in different applications and actual performance may vary over time. All operating parameters, including "Typicals" must be validated for each customer application by customer's technical experts. ON Semiconductor does not convey any license under its patent rights nor the rights of others. ON Semiconductor products are not designed, intended, or authorized for use as a critical component in life support systems or any FDA Class 3 medical devices or medical devices with a same or similar classification in a foreign jurisdiction or any devices intended for implantation in the human body. Should Buyer purchase or use ON Semiconductor products for any such unintended or unauthorized application, Buyer shall indemnify and hold ON Semiconductor and its officers, employees, subsidiaries, affiliates, and distributors harmless against all claims, costs, damages, and expenses, and reasonable attorney fees arising out of, directly or indirectly, any claim of personal injury or death associated with such unintended or unauthorized use, even if such claim alleges that ON Semiconductor was negligent regarding the design or manufacture of the part. ON Semiconductor is an Equal Opportunity/Affirmative Action Employer. This literature is subject to all applicable copyright laws and is not for resale in any manner.

PUBLICATION ORDERING INFORMATION

LITERATURE FULFILLMENT:

Literature Distribution Center for ON Semiconductor
19521 E. 32nd Pkwy, Aurora, Colorado 80011 USA
Phone: 303-675-2175 or 800-344-3860 Toll Free USA/Canada
Fax: 303-675-2176 or 800-344-3867 Toll Free USA/Canada
Email: orderlit@onsemi.com

N. American Technical Support: 800-282-9855 Toll Free
USA/Canada
Europe, Middle East and Africa Technical Support:
Phone: 421 33 790 2910
Japan Customer Focus Center
Phone: 81-3-5817-1050

ON Semiconductor Website: www.onsemi.com
Order Literature: <http://www.onsemi.com/orderlit>
For additional information, please contact your local
Sales Representative

X-ON Electronics

Largest Supplier of Electrical and Electronic Components

Click to view similar products for [Bipolar Transistors - BJT category](#):

Click to view products by [ON Semiconductor manufacturer](#):

Other Similar products are found below :

[619691C](#) [MCH4017-TL-H](#) [BC546/116](#) [BC557/116](#) [BSW67A](#) [NTE158](#) [NTE187A](#) [NTE195A](#) [NTE2302](#) [NTE2330](#) [NTE63](#) [C4460](#)
[2SA1419T-TD-H](#) [2SA1721-O\(TE85L,F\)](#) [2SA2126-E](#) [2SB1204S-TL-E](#) [2SC5488A-TL-H](#) [2SD2150T100R](#) [SP000011176](#) [FMMTA92QTA](#)
[2N2369ADCSM](#) [2SC2412KT146S](#) [2SC5490A-TL-H](#) [2SD1816S-TL-E](#) [2SD1816T-TL-E](#) [CMXT2207 TR](#) [CPH6501-TL-E](#) [MCH4021-TL-E](#)
[US6T6TR](#) [732314D](#) [CMXT3906 TR](#) [CPH3121-TL-E](#) [CPH6021-TL-H](#) [873787E](#) [IMZ2AT108](#) [UMX21NTR](#) [EMT2T2R](#) [MCH6102-TL-E](#)
[FP204-TL-E](#) [NJL0302DG](#) [2N3583](#) [2SA1434-TB-E](#) [2SC3143-4-TB-E](#) [2SD1621S-TD-E](#) [NTE103](#) [30A02MH-TL-E](#) [NSV40301MZ4T1G](#)
[NTE101](#) [NTE13](#) [NTE15](#)