

# ESD7002, SZESD7002

## ESD Protection Diode

### Low Capacitance ESD Protection Diode for High Speed Data Line

The ESD7002 surge protection device is designed to protect high speed data lines from ESD. Ultra-low capacitance and low ESD clamping voltage make this device an ideal solution for protecting voltage sensitive high speed data lines. The flow-through style package allows for easy PCB layout and matched trace lengths necessary to maintain consistent impedance between high speed differential lines such as USB 3.0 and HDMI.

#### Features

- Low Capacitance (0.3 pF Typical, I/O to GND)
- Diode capacitance matching
- Protection for the Following IEC Standards:
- IEC 61000-4-2 (Level 4)
- Low ESD Clamping Voltage
- SZ Prefix for Automotive and Other Applications Requiring Unique Site and Control Change Requirements; AEC-Q101 Qualified and PPAP Capable
- These Devices are Pb-Free and are RoHS Compliant

#### Typical Applications

- USB2.0/3.0
- LVDS
- HDMI
- High Speed Differential Pairs

#### MAXIMUM RATINGS (T<sub>J</sub> = 25°C unless otherwise noted)

Rating	Symbol	Value	Unit
Operating Junction Temperature Range	T <sub>J</sub>	-55 to +125	°C
Storage Temperature Range	T <sub>stg</sub>	-55 to +150	°C
Lead Solder Temperature – Maximum (10 Seconds)	T <sub>L</sub>	260	°C
IEC 61000-4-2 Contact (ESD)	ESD	±8	kV
IEC 61000-4-2 Air (ESD)	ESD	±15	kV

Stresses exceeding those listed in the Maximum Ratings table may damage the device. If any of these limits are exceeded, device functionality should not be assumed, damage may occur and reliability may be affected.



ON Semiconductor®

[www.onsemi.com](http://www.onsemi.com)

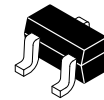

SC-70  
CASE 419  
STYLE 4

#### MARKING DIAGRAM

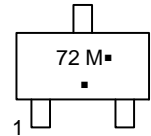

72 = Specific Device Code  
M = Date Code  
▪ = Pb-Free Package

(Note: Microdot may be in either location)

#### PIN CONFIGURATION AND SCHEMATIC

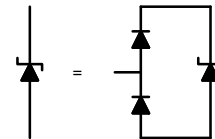
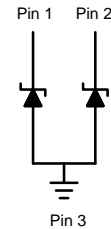

#### ORDERING INFORMATION

See detailed ordering, marking and shipping information in the package dimensions section on page 5 of this data sheet.

# ESD7002, SZESD7002

## ELECTRICAL CHARACTERISTICS ( $T_A = 25^\circ\text{C}$ unless otherwise specified)

Parameter	Symbol	Conditions	Min	Typ	Max	Unit
Reverse Working Voltage	$V_{RWM}$	I/O Pin to GND			16	V
Breakdown Voltage	$V_{BR}$	$I_T = 1\text{ mA}$ , I/O Pin to GND	16.5	23		V
Reverse Leakage Current	$I_R$	$V_{RWM} = 5\text{ V}$ , I/O Pin to GND			1	$\mu\text{A}$
Clamping Voltage (Note 1)	$V_C$	IEC61000-4-2, $\pm 8\text{ kV}$ Contact	See Figures 3 and 4			
Clamping Voltage TLP (Note 2)	$V_C$	$I_{PP} = 8\text{ A}$ $I_{PP} = 16\text{ A}$ $I_{PP} = -8\text{ A}$ $I_{PP} = -16\text{ A}$		31.2 33.9 -5.5 -10.8		V
Junction Capacitance Match	$\Delta C_J$	$V_R = 0\text{ V}$ , $f = 1\text{ MHz}$ between I/O1 to GND and I/O 2 to GND		5	10	%
Junction Capacitance	$C_J$	$V_R = 0\text{ V}$ , $f = 1\text{ MHz}$ between I/O Pins		0.2	0.4	$\mu\text{F}$
Junction Capacitance	$C_J$	$V_R = 0\text{ V}$ , $f = 1\text{ MHz}$ between I/O Pins and GND		0.3	0.5	$\mu\text{F}$
3dB Bandwidth	$f_{BW}$	$R_L = 50\ \Omega$		5		GHz

- For test procedure see Figures 5 and 6 and application note AND8307/D.
- ANSI/ESD STM5.5.1 – Electrostatic Discharge Sensitivity Testing using Transmission Line Pulse (TLP) Model.  
TLP conditions:  $Z_0 = 50\ \Omega$ ,  $t_p = 100\text{ ns}$ ,  $t_r = 4\text{ ns}$ , averaging window;  $t_1 = 30\text{ ns}$  to  $t_2 = 60\text{ ns}$ .

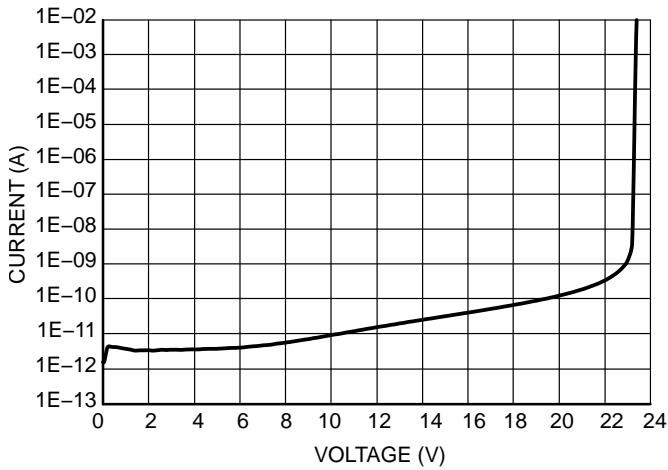

Figure 1. Typical IV Characteristic Curve

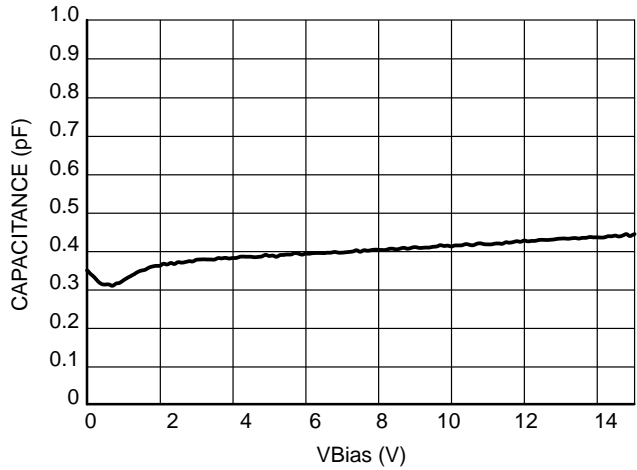

Figure 2. Typical CV Characteristic Curve

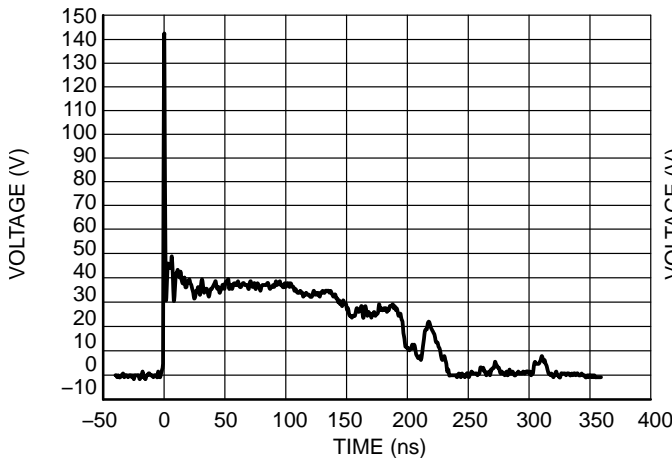

Figure 3. IEC61000-4-2 +8 kV Contact ESD Clamping Voltage

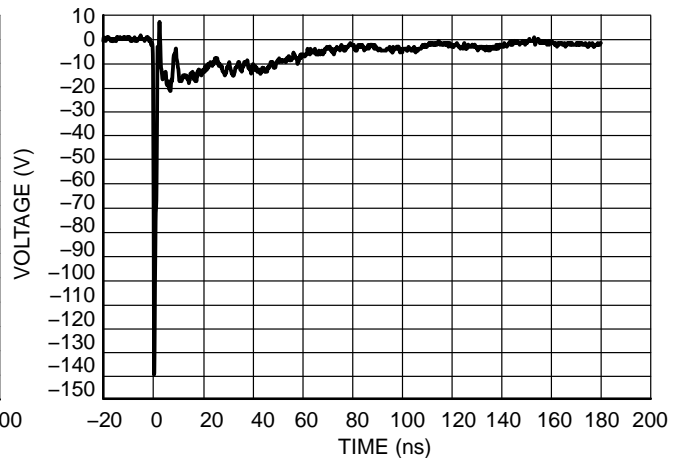

Figure 4. IEC61000-4-2 -8 kV Contact ESD Clamping Voltage

## ESD7002, SZESD7002

### IEC 61000-4-2 Spec.

Level	Test Voltage (kV)	First Peak Current (A)	Current at 30 ns (A)	Current at 60 ns (A)
1	2	7.5	4	2
2	4	15	8	4
3	6	22.5	12	6
4	8	30	16	8

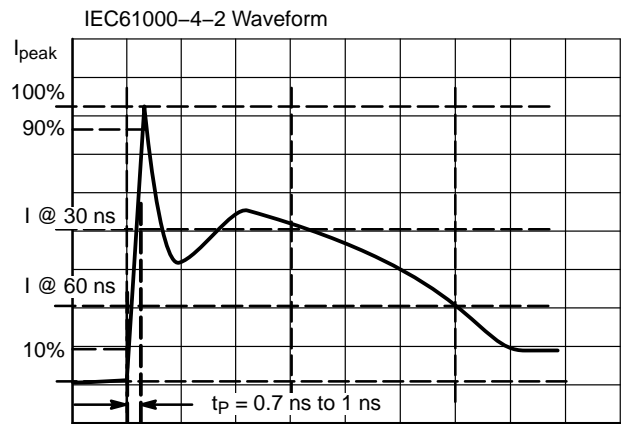

Figure 5. IEC61000-4-2 Spec

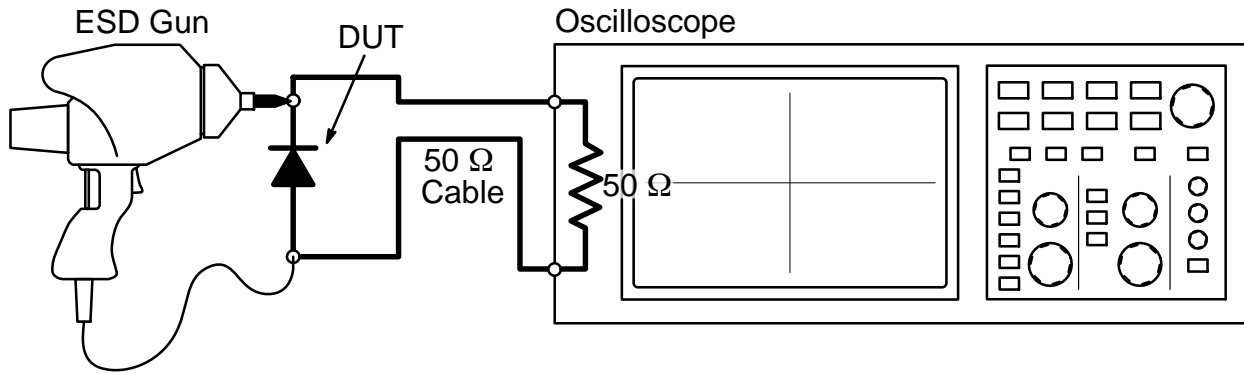

Figure 6. Diagram of ESD Clamping Voltage Test Setup

The following is taken from Application Note AND8308/D – Interpretation of Datasheet Parameters for ESD Devices.

### ESD Voltage Clamping

For sensitive circuit elements it is important to limit the voltage that an IC will be exposed to during an ESD event to as low a voltage as possible. The ESD clamping voltage is the voltage drop across the ESD protection diode during an ESD event per the IEC61000-4-2 waveform. Since the IEC61000-4-2 was written as a pass/fail spec for larger

systems such as cell phones or laptop computers it is not clearly defined in the spec how to specify a clamping voltage at the device level. ON Semiconductor has developed a way to examine the entire voltage waveform across the ESD protection diode over the time domain of an ESD pulse in the form of an oscilloscope screenshot, which can be found on the datasheets for all ESD protection diodes. For more information on how ON Semiconductor creates these screenshots and how to interpret them please refer to AND8307/D.

## ESD7002, SZESD7002

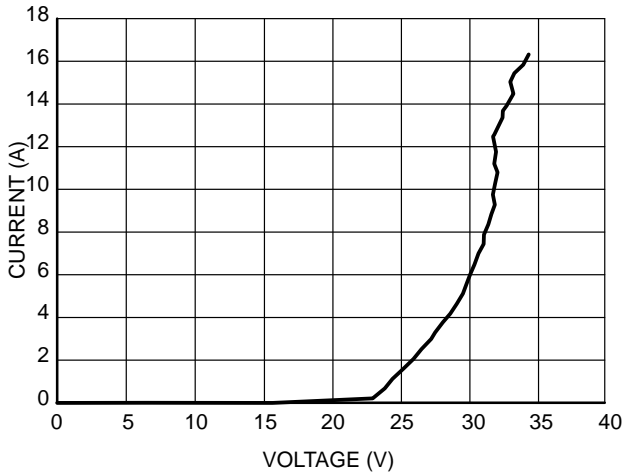

**Figure 7. Positive TLP IV Curve**

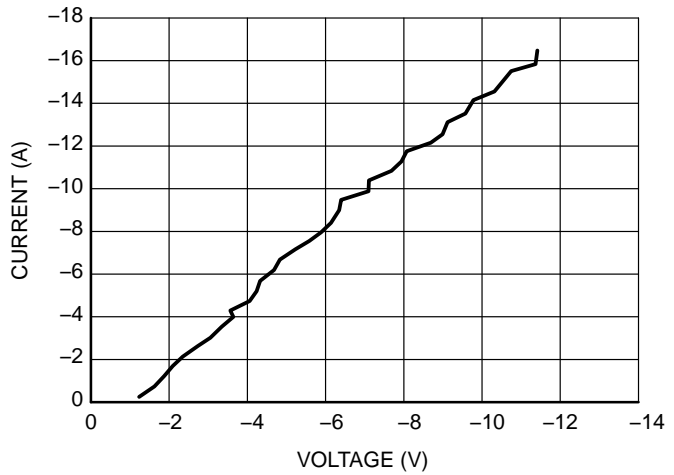
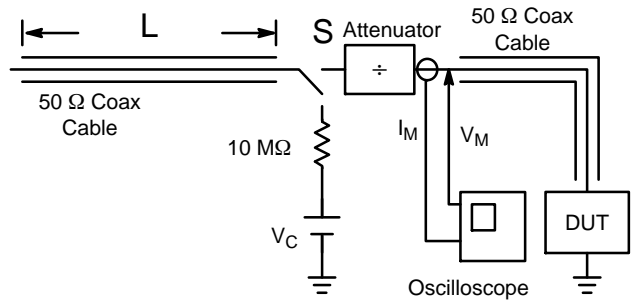

**Figure 8. Negative TLP IV Curve**

NOTE: TLP parameter:  $Z_0 = 50 \Omega$ ,  $t_p = 100 \text{ ns}$ ,  $t_r = 300 \text{ ps}$ , averaging window:  $t_1 = 30 \text{ ns}$  to  $t_2 = 60 \text{ ns}$ .

### Transmission Line Pulse (TLP) Measurement

Transmission Line Pulse (TLP) provides current versus voltage (I-V) curves in which each data point is obtained from a 100 ns long rectangular pulse from a charged transmission line. A simplified schematic of a typical TLP system is shown in Figure 9. TLP I-V curves of ESD protection devices accurately demonstrate the product's ESD capability because the 10s of amps current levels and under 100 ns time scale match those of an ESD event. This is illustrated in Figure 10 where an 8 kV IEC 61000-4-2 current waveform is compared with TLP current pulses at 8 A and 16 A. A TLP I-V curve shows the voltage at which the device turns on as well as how well the device clamps voltage over a range of current levels.



**Figure 9. Simplified Schematic of a Typical TLP System**

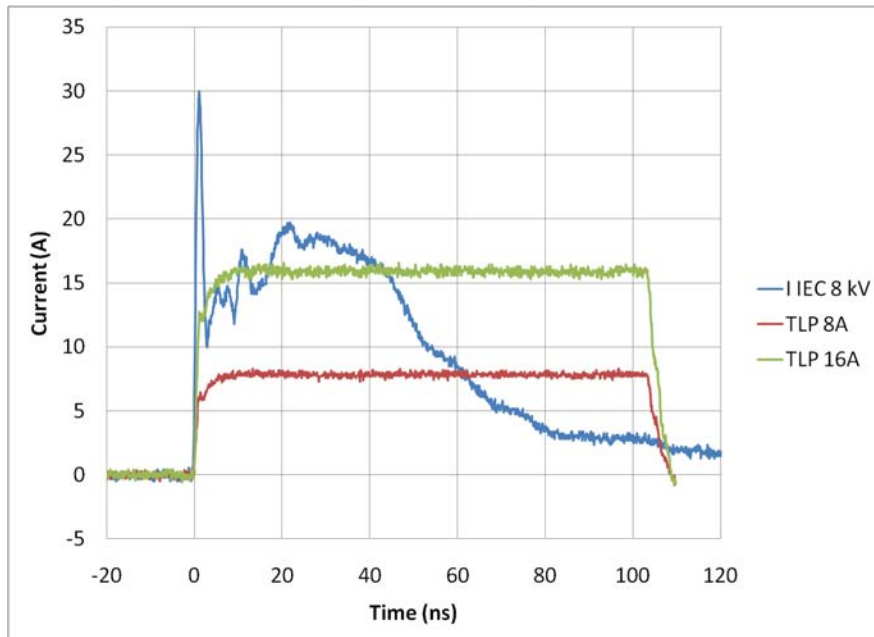

**Figure 10. Comparison Between 8 kV IEC 61000-4-2 and 8 A and 16 A TLP Waveforms**

# ESD7002, SZESD7002

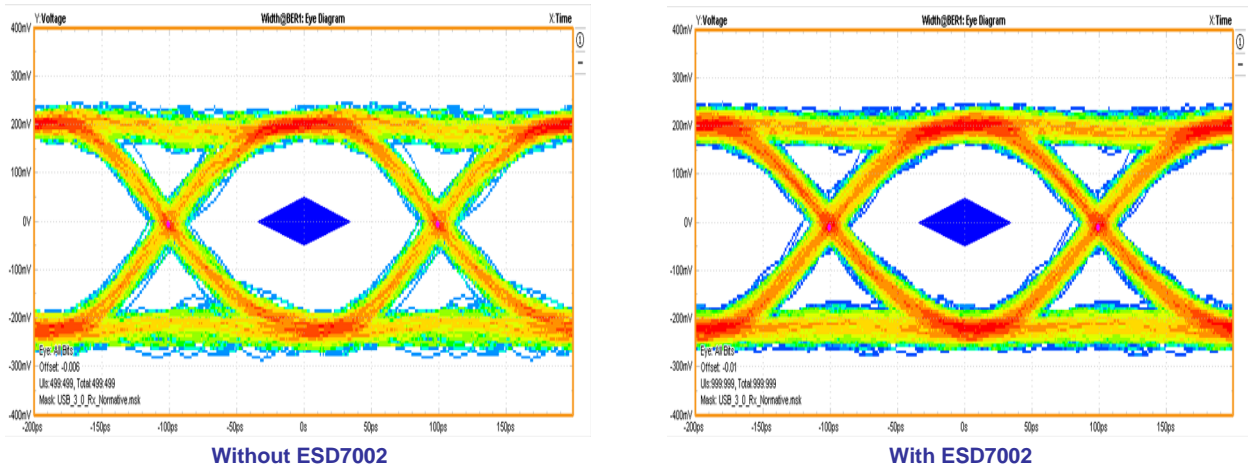

Figure 11. USB3.0 Eye Diagram with and without ESD7002 at 5 Gb/s

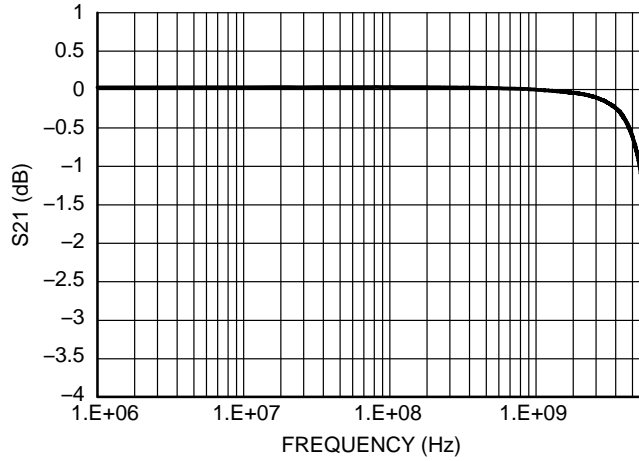

Figure 12. Typical Insertion Loss

## ORDERING INFORMATION

Device	Package	Shipping†
ESD7002WTT1G	SC-70 (Pb-Free)	3000 / Tape & Reel
SZESD7002WTT1G*	SC-70 (Pb-Free)	3000 / Tape & Reel

†For information on tape and reel specifications, including part orientation and tape sizes, please refer to our Tape and Reel Packaging Specifications Brochure, BRD8011/D.

\*SZ Prefix for Automotive and Other Applications Requiring Unique Site and Control Change Requirements; AEC-Q100 Qualified and PPAP Capable.

# MECHANICAL CASE OUTLINE PACKAGE DIMENSIONS

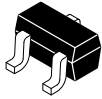

SCALE 4:1

SC-70 (SOT-323)  
CASE 419  
ISSUE P

DATE 07 OCT 2021

NOTES:

1. DIMENSIONING AND TOLERANCING PER ASME Y14.5M, 1982.
2. CONTROLLING DIMENSION: INCH

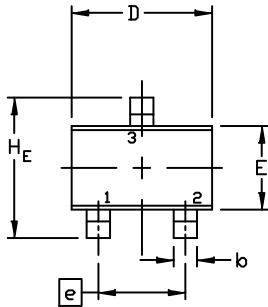

TOP VIEW

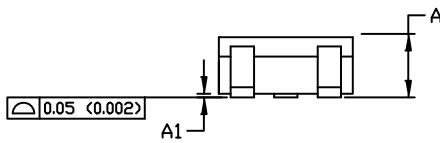

SIDE VIEW

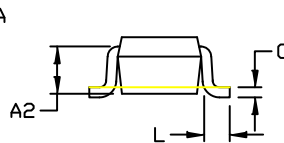

END VIEW

DIM	MILLIMETERS			INCHES		
	MIN.	NDM.	MAX.	MIN.	NDM.	MAX.
A	0.80	0.90	1.00	0.032	0.035	0.040
A1	0.00	0.05	0.10	0.000	0.002	0.004
A2	0.70 REF			0.028 BSC		
b	0.30	0.35	0.40	0.012	0.014	0.016
c	0.10	0.18	0.25	0.004	0.007	0.010
D	1.80	2.10	2.20	0.071	0.083	0.087
E	1.15	1.24	1.35	0.045	0.049	0.053
e	1.20	1.30	1.40	0.047	0.051	0.055
e1	0.65 BSC			0.026 BSC		
L	0.20	0.38	0.56	0.008	0.015	0.022
H <sub>E</sub>	2.00	2.10	2.40	0.079	0.083	0.095

GENERIC  
MARKING DIAGRAM

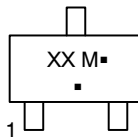

- XX = Specific Device Code
- M = Date Code
- = Pb-Free Package

\*This information is generic. Please refer to device data sheet for actual part marking. Pb-Free indicator, "G" or microdot "▪", may or may not be present. Some products may not follow the Generic Marking.

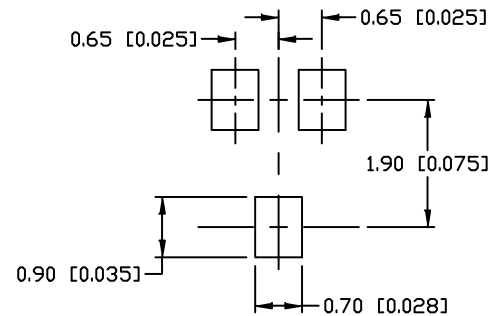

\* For additional information on our Pb-Free strategy and soldering details, please download the DN Semiconductor Soldering and Mounting Techniques Reference Manual, SOLDERRM/D.

SOLDERING FOOTPRINT

- |   |   |   |  |   |   |
|---|---|---|--|---|---|
| STYLE 1:<br>CANCELLED                                 | STYLE 2:<br>PIN 1. ANODE<br>2. N.C.<br>3. CATHODE     | STYLE 3:<br>PIN 1. BASE<br>2. EMITTER<br>3. COLLECTOR | STYLE 4:<br>PIN 1. CATHODE<br>2. CATHODE<br>3. ANODE       | STYLE 5:<br>PIN 1. ANODE<br>2. ANODE<br>3. CATHODE          |   |
| STYLE 6:<br>PIN 1. EMITTER<br>2. BASE<br>3. COLLECTOR | STYLE 7:<br>PIN 1. BASE<br>2. EMITTER<br>3. COLLECTOR | STYLE 8:<br>PIN 1. GATE<br>2. SOURCE<br>3. DRAIN      | STYLE 9:<br>PIN 1. ANODE<br>2. CATHODE<br>3. CATHODE-ANODE | STYLE 10:<br>PIN 1. CATHODE<br>2. ANODE<br>3. ANODE-CATHODE | STYLE 11:<br>PIN 1. CATHODE<br>2. CATHODE<br>3. CATHODE |

DOCUMENT NUMBER:	98ASB42819B	Electronic versions are uncontrolled except when accessed directly from the Document Repository. Printed versions are uncontrolled except when stamped "CONTROLLED COPY" in red.
DESCRIPTION:	SC-70 (SOT-323)	PAGE 1 OF 1

onsemi and ONSEMI are trademarks of Semiconductor Components Industries, LLC dba onsemi or its subsidiaries in the United States and/or other countries. onsemi reserves the right to make changes without further notice to any products herein. onsemi makes no warranty, representation or guarantee regarding the suitability of its products for any particular purpose, nor does onsemi assume any liability arising out of the application or use of any product or circuit, and specifically disclaims any and all liability, including without limitation special, consequential or incidental damages. onsemi does not convey any license under its patent rights nor the rights of others.

**onsemi**, **Onsemi**, and other names, marks, and brands are registered and/or common law trademarks of Semiconductor Components Industries, LLC dba "**onsemi**" or its affiliates and/or subsidiaries in the United States and/or other countries. **onsemi** owns the rights to a number of patents, trademarks, copyrights, trade secrets, and other intellectual property. A listing of **onsemi**'s product/patent coverage may be accessed at [www.onsemi.com/site/pdf/Patent-Marking.pdf](http://www.onsemi.com/site/pdf/Patent-Marking.pdf). **onsemi** reserves the right to make changes at any time to any products or information herein, without notice. The information herein is provided "as-is" and **onsemi** makes no warranty, representation or guarantee regarding the accuracy of the information, product features, availability, functionality, or suitability of its products for any particular purpose, nor does **onsemi** assume any liability arising out of the application or use of any product or circuit, and specifically disclaims any and all liability, including without limitation special, consequential or incidental damages. Buyer is responsible for its products and applications using **onsemi** products, including compliance with all laws, regulations and safety requirements or standards, regardless of any support or applications information provided by **onsemi**. "Typical" parameters which may be provided in **onsemi** data sheets and/or specifications can and do vary in different applications and actual performance may vary over time. All operating parameters, including "Typicals" must be validated for each customer application by customer's technical experts. **onsemi** does not convey any license under any of its intellectual property rights nor the rights of others. **onsemi** products are not designed, intended, or authorized for use as a critical component in life support systems or any FDA Class 3 medical devices or medical devices with a same or similar classification in a foreign jurisdiction or any devices intended for implantation in the human body. Should Buyer purchase or use **onsemi** products for any such unintended or unauthorized application, Buyer shall indemnify and hold **onsemi** and its officers, employees, subsidiaries, affiliates, and distributors harmless against all claims, costs, damages, and expenses, and reasonable attorney fees arising out of, directly or indirectly, any claim of personal injury or death associated with such unintended or unauthorized use, even if such claim alleges that **onsemi** was negligent regarding the design or manufacture of the part. **onsemi** is an Equal Opportunity/Affirmative Action Employer. This literature is subject to all applicable copyright laws and is not for resale in any manner.

## PUBLICATION ORDERING INFORMATION

### LITERATURE FULFILLMENT:

Email Requests to: [orderlit@onsemi.com](mailto:orderlit@onsemi.com)

**onsemi Website:** [www.onsemi.com](http://www.onsemi.com)

### TECHNICAL SUPPORT

**North American Technical Support:**

Voice Mail: 1 800-282-9855 Toll Free USA/Canada

Phone: 011 421 33 790 2910

**Europe, Middle East and Africa Technical Support:**

Phone: 00421 33 790 2910

For additional information, please contact your local Sales Representative

## X-ON Electronics

Largest Supplier of Electrical and Electronic Components

*Click to view similar products for [ESD Suppressors / TVS Diodes](#) category:*

*Click to view products by [ON Semiconductor](#) manufacturer:*

Other Similar products are found below :

[60KS200C](#) [D12V0H1U2WS-7](#) [D18V0L1B2LP-7B](#) [82356050220](#) [D5V0M5U6V-7](#) [NTE4902](#) [P4KE27CA](#) [P6KE11CA](#) [P6KE39CA-TP](#)  
[P6KE8.2A](#) [SA110CA](#) [SA60CA](#) [SA64CA](#) [SMBJ12CATR](#) [SMBJ8.0A](#) [SMLJ30CA-TP](#) [ESD101-B1-02ELS E6327](#) [ESD112-B1-02EL E6327](#)  
[ESD119B1W01005E6327XTSA1](#) [ESD5V0J4-TP](#) [ESD5V0L1B02VH6327XTSA1](#) [ESD7451N2T5G](#) [19180-510](#) [CPDT-5V0USP-HF](#)  
[3.0SMCJ33CA-F](#) [3.0SMCJ36A-F](#) [HSPC16701B02TP](#) [D3V3Q1B2DLP3-7](#) [D55V0M1B2WS-7](#) [DESD5V0U1BL-7B](#) [DRTR5V0U4SL-7](#)  
[SCM1293A-04SO](#) [ESD200-B1-CSP0201 E6327](#) [ESD203-B1-02EL E6327](#) [SM12-7](#) [SMF8.0A-TP](#) [SMLJ45CA-TP](#) [CEN955 W/DATA](#)  
[82350120560](#) [82356240030](#) [VESD12A1A-HD1-GS08](#) [CPDUR5V0R-HF](#) [CPDUR24V-HF](#) [CPDQC5V0U-HF](#) [CPDQC5V0USP-HF](#)  
[CPDQC5V0-HF](#) [D1213A-01LP4-7B](#) [D1213A-02WL-7](#) [ESDLIN1524BJ-HQ](#) [5KP100A](#)