

# ESD7008, SZESD7008

## ESD Protection Diode

### Low Capacitance ESD Protection Diode for High Speed Data Line

The ESD7008 ESD protection diode is designed specifically to protect four high speed differential pairs. Ultra-low capacitance and low ESD clamping voltage make this device an ideal solution for protecting voltage sensitive high speed data lines. The flow-through style package allows for easy PCB layout and matched trace lengths necessary to maintain consistent impedance for the high speed lines.

#### Features

- Integrated 4 Pairs (8 Lines) High Speed Data
- Single Connect, Flow through Routing
- Low Capacitance (0.12 pF Typical, I/O to GND)
- Protection for the Following IEC Standards:  
IEC 61000-4-2 Level 4
- UL Flammability Rating of 94 V-0
- SZ Prefix for Automotive and Other Applications Requiring Unique Site and Control Change Requirements; AEC-Q101 Qualified and PPAP Capable
- This is a Pb-Free Device

#### Typical Applications

- V-by-One HS
- Thunderbolt (Light Peak)
- USB 3.0
- HDMI
- Display Port
- LVDS

#### MAXIMUM RATINGS (T<sub>J</sub> = 25°C unless otherwise noted)

Rating	Symbol	Value	Unit
Operating Junction Temperature Range	T <sub>J</sub>	-55 to +125	°C
Storage Temperature Range	T <sub>stg</sub>	-55 to +150	°C
Lead Solder Temperature – Maximum (10 Seconds)	T <sub>L</sub>	260	°C
IEC 61000-4-2 Contact (ESD)	ESD	±15	kV
IEC 61000-4-2 Air (ESD)	ESD	±15	kV

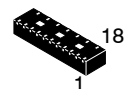
Stresses exceeding those listed in the Maximum Ratings table may damage the device. If any of these limits are exceeded, device functionality should not be assumed, damage may occur and reliability may be affected.

See Application Note AND8308/D for further description of survivability specs.



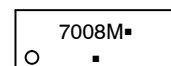
ON Semiconductor®

[www.onsemi.com](http://www.onsemi.com)



UDFN18  
CASE 517BV

#### MARKING DIAGRAM



7008 = Specific Device Code  
M = Date Code  
▪ = Pb-Free Package

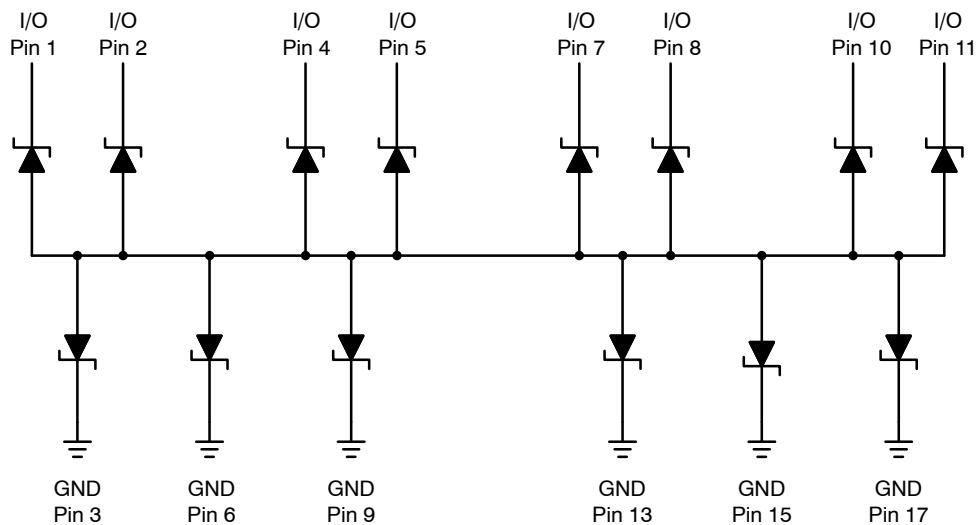
(Note: Microdot may be in either location)

#### ORDERING INFORMATION

Device	Package	Shipping
ESD7008MUTAG	UDFN18 (Pb-Free)	3000 / Tape & Reel
SZESD7008MUTAG	UDFN18 (Pb-Free)	3000 / Tape & Reel

†For information on tape and reel specifications, including part orientation and tape sizes, please refer to our Tape and Reel Packaging Specification Brochure, BRD8011/D.

# ESD7008, SZESD7008



Note: Only Minimum of 1 GND connection required

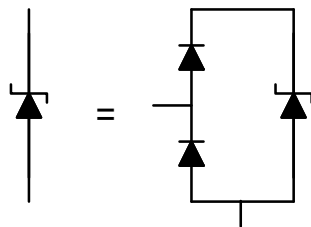


Figure 1. Pin Schematic

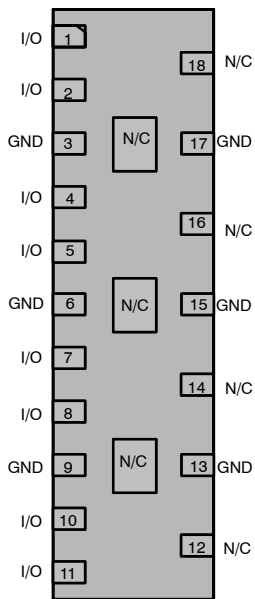


Figure 2. Pin Configuration

Note: Only minimum of one pin needs to be connected to ground for functionality of all pins. All pins labeled "N/C" should have no electrical connection.

# ESD7008, SZESD7008

## ELECTRICAL CHARACTERISTICS ( $T_A = 25^\circ\text{C}$ unless otherwise specified)

Parameter	Symbol	Conditions	Min	Typ	Max	Unit
Reverse Working Voltage	$V_{RWM}$	I/O Pin to GND (Note 1)			5.0	V
Breakdown Voltage	$V_{BR}$	$I_T = 1\text{ mA}$ , I/O Pin to GND	5.5	6.7		V
Reverse Leakage Current	$I_R$	$V_{RWM} = 5\text{ V}$ , I/O Pin to GND			1.0	$\mu\text{A}$
Clamping Voltage (Note 1)	$V_C$	$I_{PP} = 1\text{ A}$ , I/O Pin to GND (8 x 20 $\mu\text{s}$ pulse)			10	V
Clamping Voltage (Note 2)	$V_C$	IEC61000-4-2, $\pm 8\text{ kV}$ Contact	See Figures 3 and 4			V
Clamping Voltage TLP (Note 3) See Figures 8 through 11	$V_C$	$I_{PP} = \pm 8\text{ A}$ $I_{PP} = \pm 16\text{ A}$		13.2 18.2		
Junction Capacitance	$C_J$	$V_R = 0\text{ V}$ , $f = 1\text{ MHz}$ between I/O Pins and GND		0.12	0.15	pF
Junction Capacitance Difference	$\Delta C_J$	$V_R = 0\text{ V}$ , $f = 1\text{ MHz}$ between I/O Pins and GND		0.02		pF

- Surge current waveform per Figure 7.
- For test procedure see Figures 5 and 6 and application note AND8307/D.
- ANSI/ESD STM5.5.1 – Electrostatic Discharge Sensitivity Testing using Transmission Line Pulse (TLP) Model.  
TLP conditions:  $Z_0 = 50\ \Omega$ ,  $t_p = 100\text{ ns}$ ,  $t_r = 4\text{ ns}$ , averaging window;  $t_1 = 30\text{ ns}$  to  $t_2 = 60\text{ ns}$ .

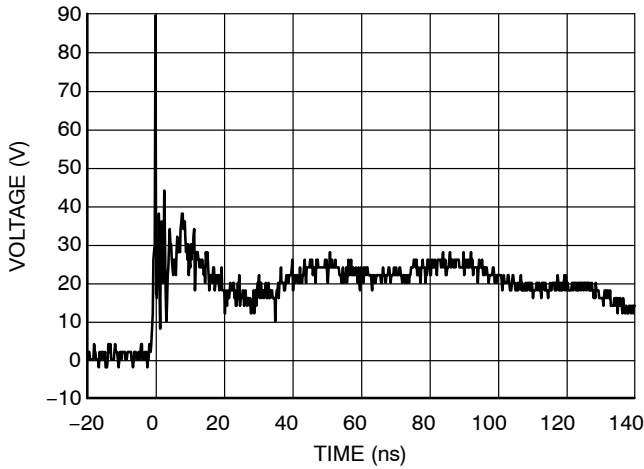


Figure 3. IEC61000-4-2 +8 KV Contact Clamping Voltage

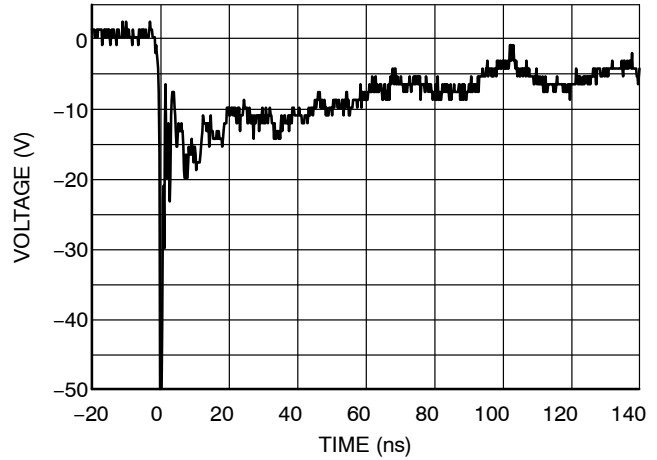


Figure 4. IEC61000-4-2 -8 KV Contact Clamping Voltage

# ESD7008, SZESD7008

## IEC 61000-4-2 Spec.

Level	Test Voltage (kV)	First Peak Current (A)	Current at 30 ns (A)	Current at 60 ns (A)
1	2	7.5	4	2
2	4	15	8	4
3	6	22.5	12	6
4	8	30	16	8



Figure 5. IEC61000-4-2 Spec

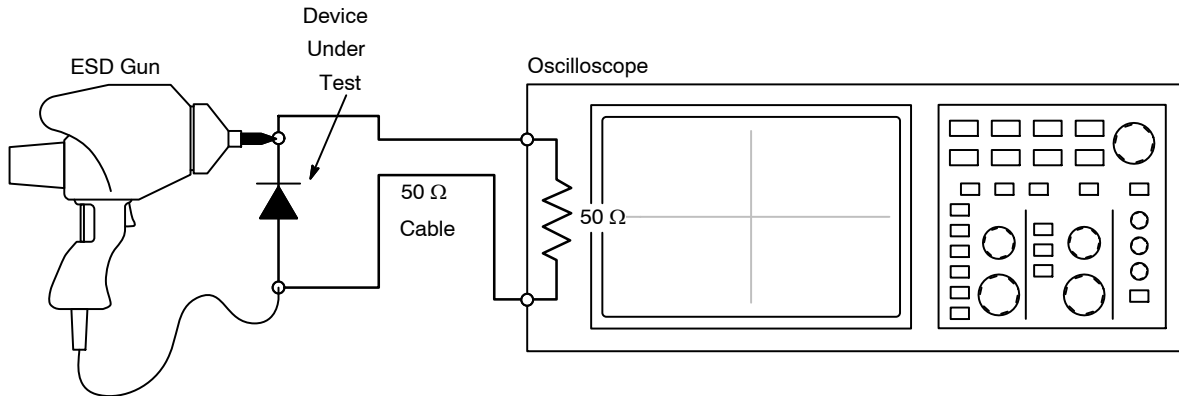


Figure 6. Diagram of ESD Clamping Voltage Test Setup

The following is taken from Application Note AND8308/D – Interpretation of Datasheet Parameters for ESD Devices.

### ESD Voltage Clamping

For sensitive circuit elements it is important to limit the voltage that an IC will be exposed to during an ESD event to as low a voltage as possible. The ESD clamping voltage is the voltage drop across the ESD protection diode during an ESD event per the IEC61000-4-2 waveform. Since the IEC61000-4-2 was written as a pass/fail spec for larger

systems such as cell phones or laptop computers it is not clearly defined in the spec how to specify a clamping voltage at the device level. ON Semiconductor has developed a way to examine the entire voltage waveform across the ESD protection diode over the time domain of an ESD pulse in the form of an oscilloscope screenshot, which can be found on the datasheets for all ESD protection diodes. For more information on how ON Semiconductor creates these screenshots and how to interpret them please refer to AND8307/D.

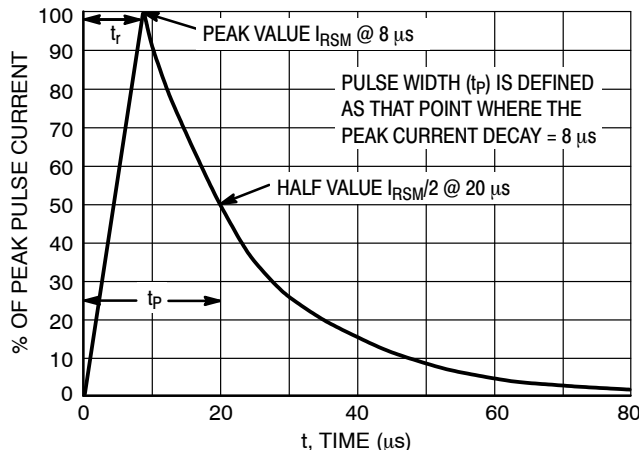
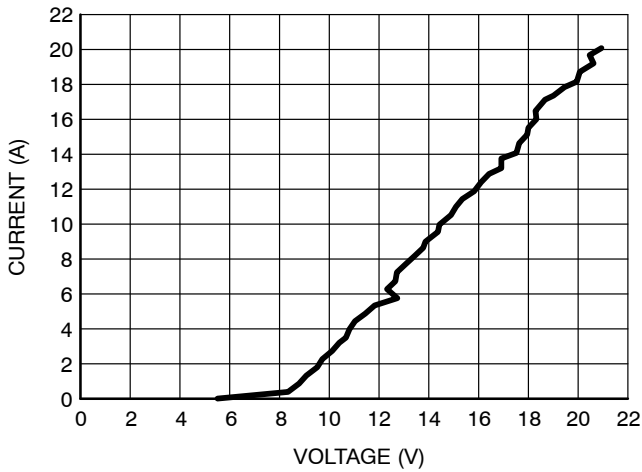
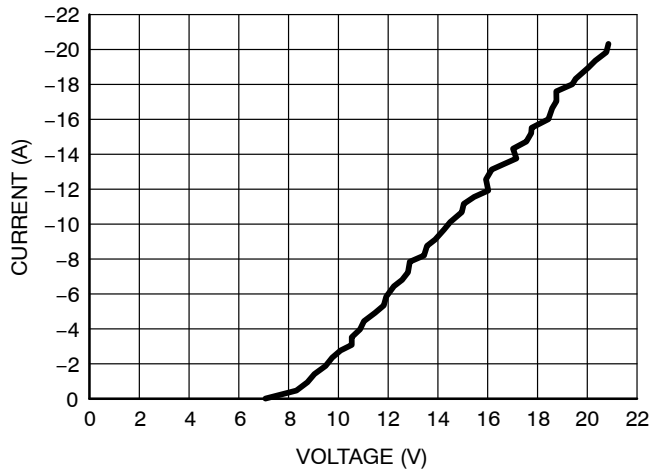


Figure 7. 8 x 20  $\mu$ s Pulse Waveform

## ESD7008, SZESD7008



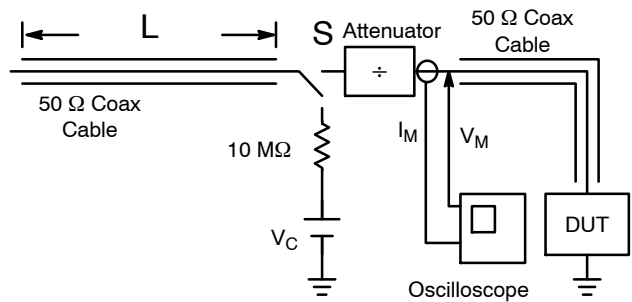
**Figure 8. Positive TLP I-V Curve**



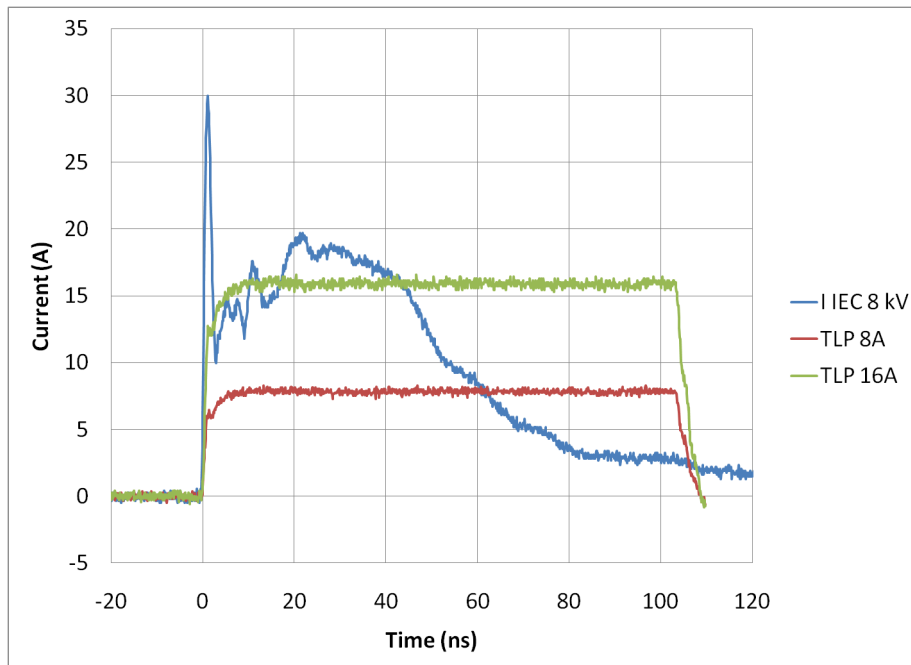
**Figure 9. Negative TLP I-V Curve**

### Transmission Line Pulse (TLP) Measurement

Transmission Line Pulse (TLP) provides current versus voltage (I-V) curves in which each data point is obtained from a 100 ns long rectangular pulse from a charged transmission line. A simplified schematic of a typical TLP system is shown in Figure 10. TLP I-V curves of ESD protection devices accurately demonstrate the product's ESD capability because the 10s of amps current levels and under 100 ns time scale match those of an ESD event. This is illustrated in Figure 11 where an 8 kV IEC 61000-4-2 current waveform is compared with TLP current pulses at 8 A and 16 A. A TLP I-V curve shows the voltage at which the device turns on as well as how well the device clamps voltage over a range of current levels.

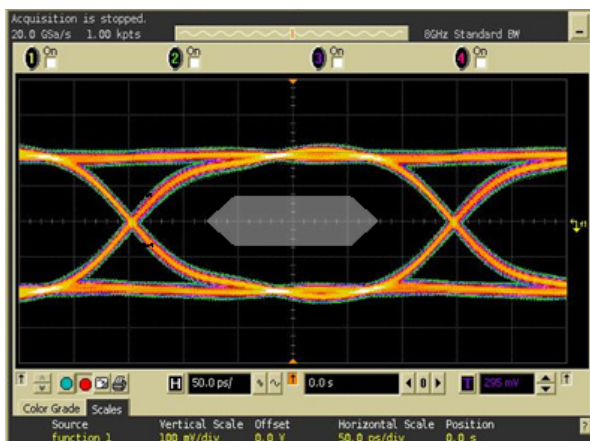


**Figure 10. Simplified Schematic of a Typical TLP System**

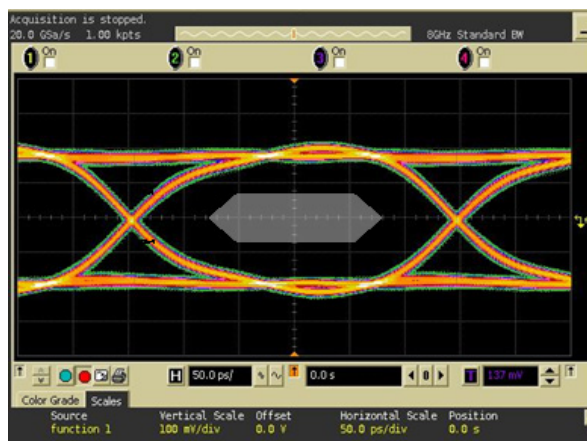


**Figure 11. Comparison Between 8 kV IEC 61000-4-2 and 8 A and 16 A TLP Waveforms**

# ESD7008, SZESD7008

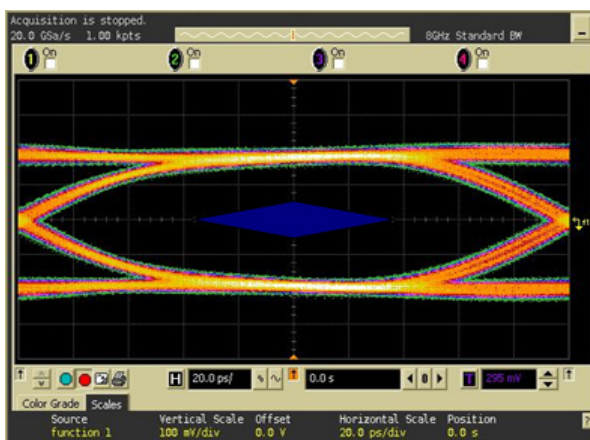


Without ESD

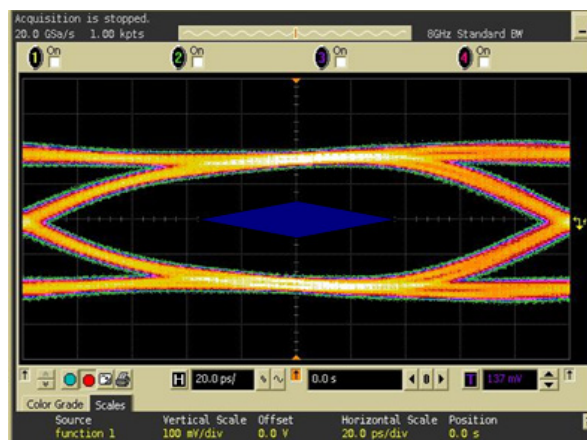


With ESD7008

Figure 12. HDMI1.4 Eye Diagram with and without ESD7008. 3.4 Gb/s, 400 mV<sub>pp</sub>

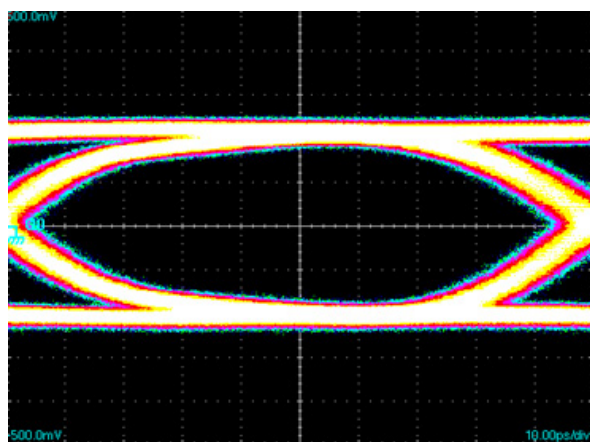


Without ESD

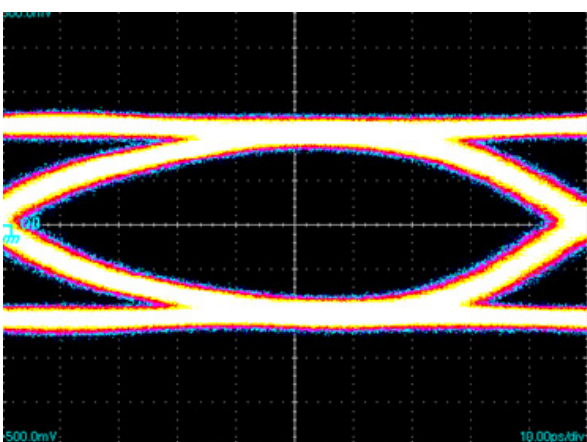


With ESD7008

Figure 13. USB3.0 Eye Diagram with and without ESD7008. 5.0 Gb/s, 400 mV<sub>pp</sub>



Without ESD



With ESD7008

Figure 14. Thunderbolt Eye Diagram with and without ESD7008. 10 Gb/s, 400 mV<sub>pp</sub>

## ESD7008, SZESD7008

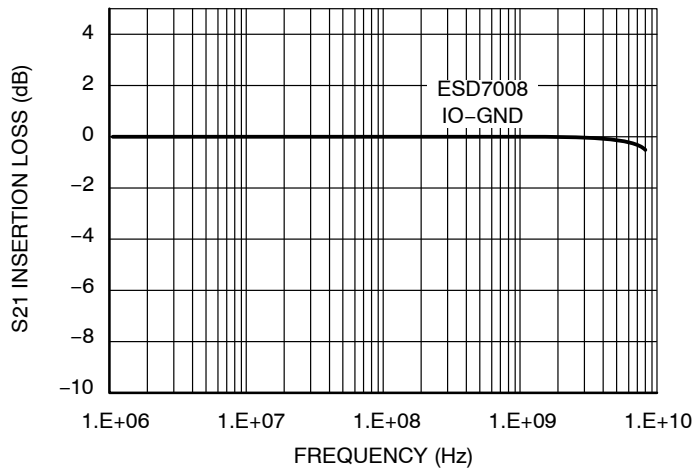


Figure 15. ESD7008 Insertion Loss

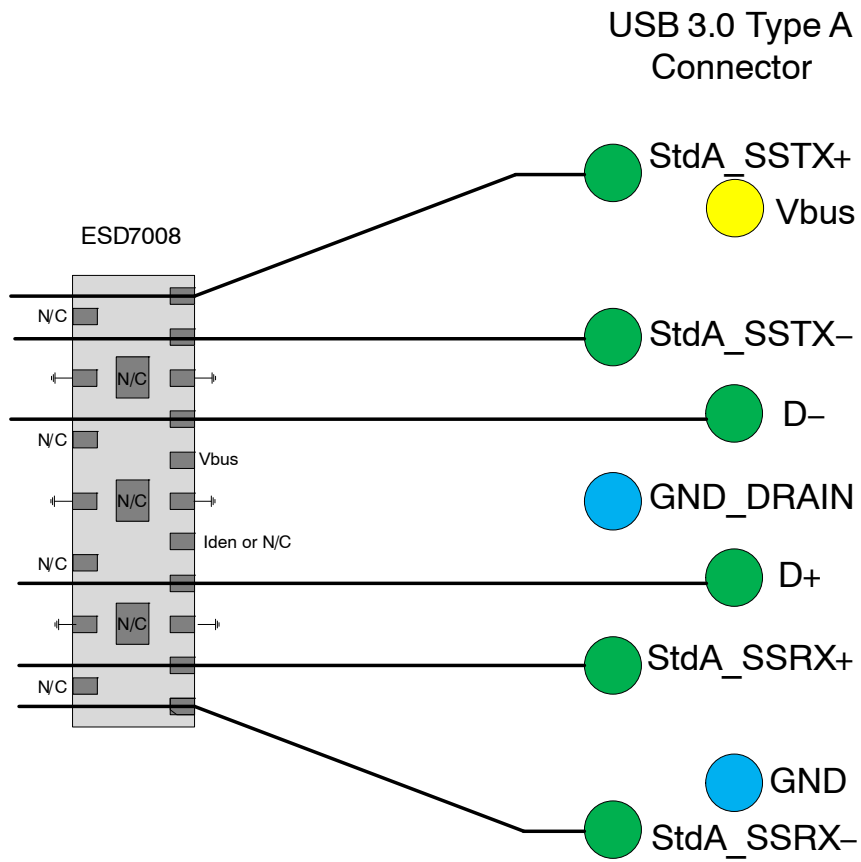


Figure 16. USB3.0 Layout Diagram

# ESD7008, SZESD7008

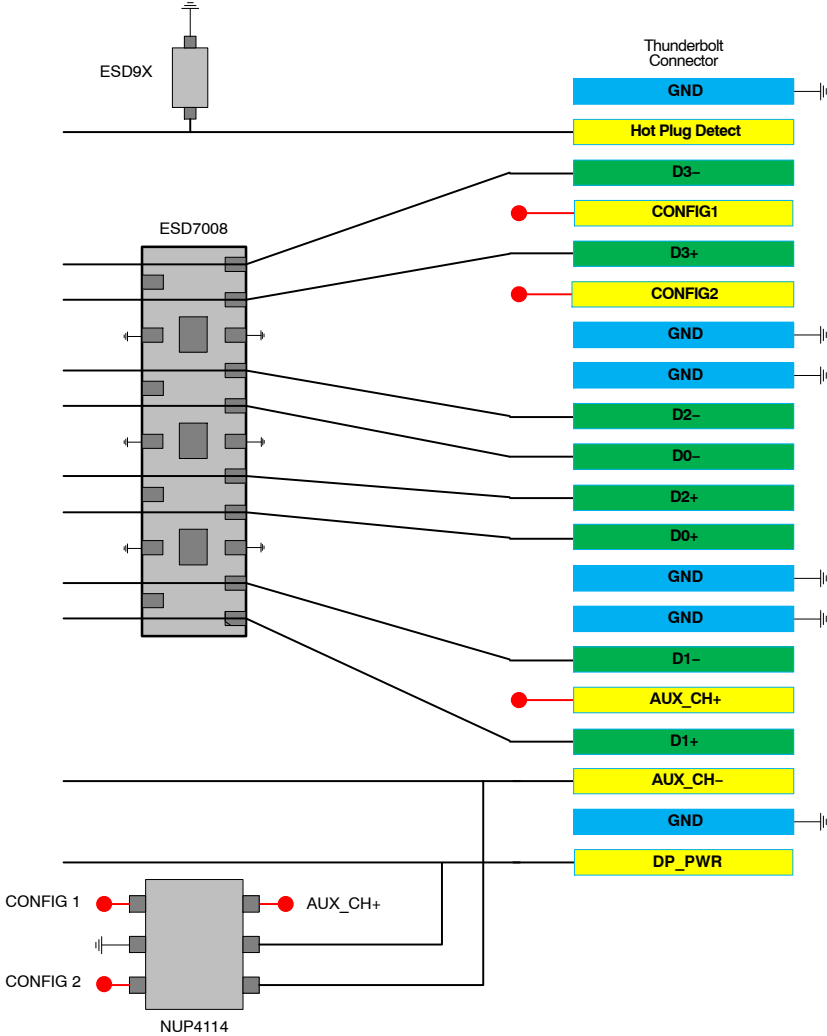
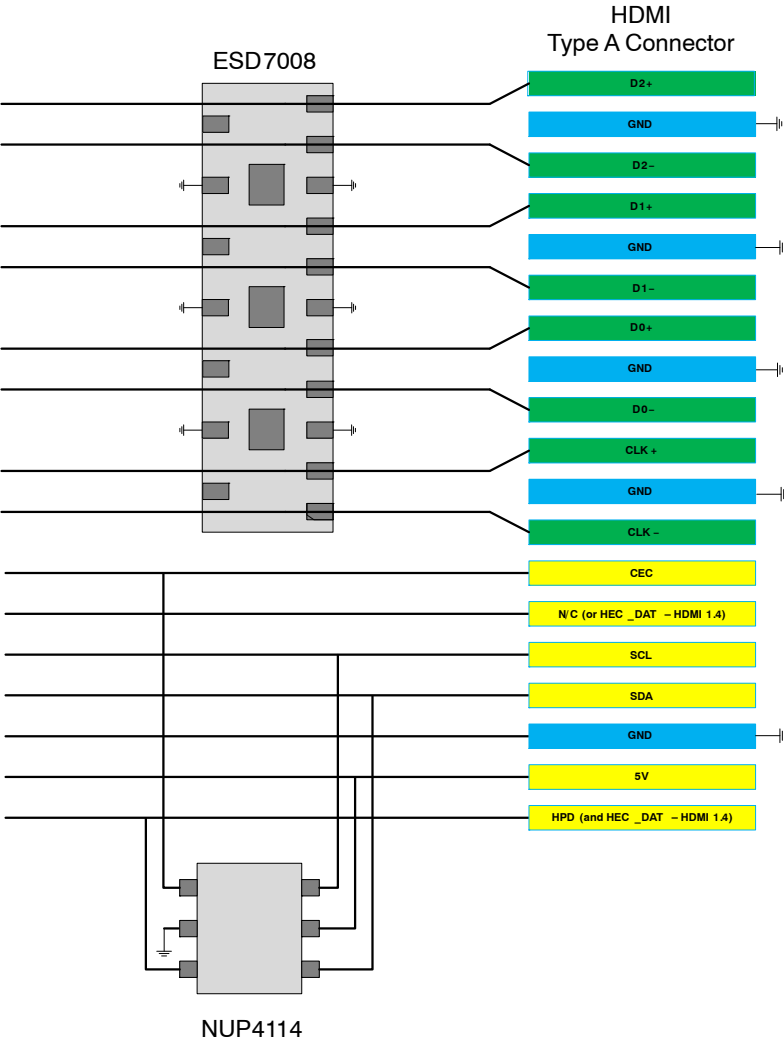


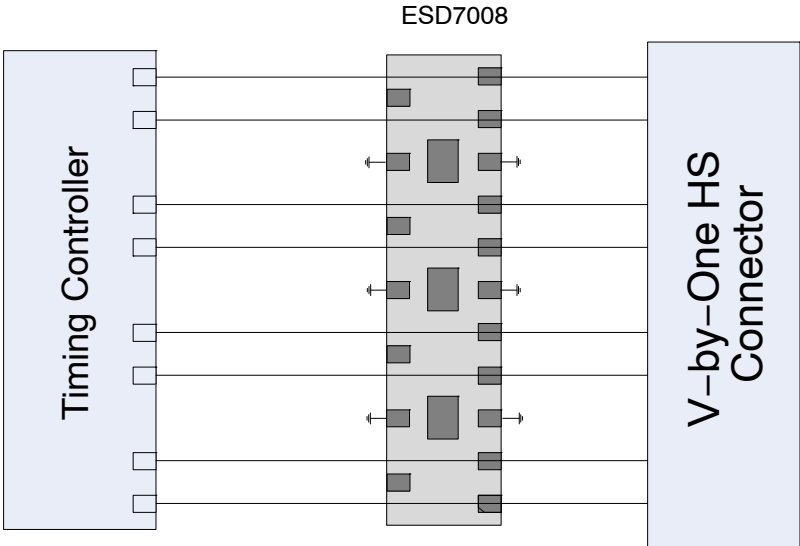
Figure 17. Thunderbolt Layout Diagram



**ESD7008, SZESD7008**



**Figure 18. HDMI Layout Diagram**

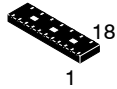


**Figure 19. V-by-One HS Layout Diagram (for LCD Panel)**

# MECHANICAL CASE OUTLINE

## PACKAGE DIMENSIONS

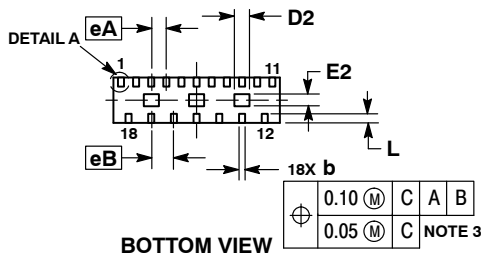
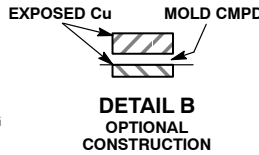
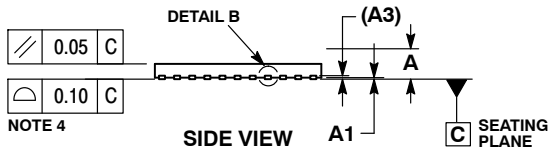
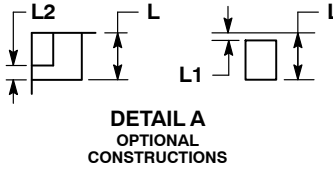
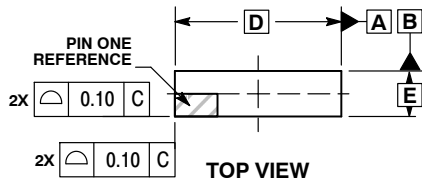
ON Semiconductor®



SCALE 2:1

### UDFN18, 5.5x1.5, 0.5P CASE 517BV ISSUE A

DATE 11 DEC 2012

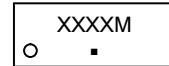


**NOTES:**

1. DIMENSIONING AND TOLERANCING PER ASME Y14.5M, 1994.
2. CONTROLLING DIMENSION: MILLIMETERS.
3. DIMENSION b APPLIES TO PLATED TERMINAL AND IS MEASURED BETWEEN 0.10 AND 0.20 MM FROM TERMINAL TIP.
4. COPLANARITY APPLIES TO THE EXPOSED PAD AS WELL AS THE TERMINALS.
5. EXPOSED ENDS OF TERMINALS ARE ELECTRICALLY ACTIVE.

DIM	MILLIMETERS	
	MIN	MAX
A	0.45	0.55
A1	0.00	0.05
A3	0.13	REF
b	0.15	0.25
D	5.50	BSC
D2	0.45	0.55
E	1.50	BSC
E2	0.35	0.45
eA	0.50	BSC
eB	0.75	BSC
L	0.20	0.40
L1	0.00	0.05
L2	0.10	REF

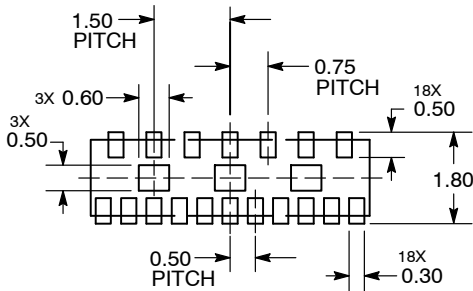
### GENERIC MARKING DIAGRAM\*



- XXXX = Specific Device Code
- M = Date Code
- = Pb-Free Package

\*This information is generic. Please refer to device data sheet for actual part marking.

### RECOMMENDED SOLDERING FOOTPRINT\*



\*For additional information on our Pb-Free strategy and soldering details, please download the ON Semiconductor Soldering and Mounting Techniques Reference Manual, SOLDERRM/D.

<b>DOCUMENT NUMBER:</b>	<b>98AON55750E</b>	Electronic versions are uncontrolled except when accessed directly from the Document Repository. Printed versions are uncontrolled except when stamped "CONTROLLED COPY" in red.
<b>DESCRIPTION:</b>	<b>UDFN18, 5.5X1.5, 0.5P</b>	<b>PAGE 1 OF 1</b>

ON Semiconductor and ON are trademarks of Semiconductor Components Industries, LLC dba ON Semiconductor or its subsidiaries in the United States and/or other countries. ON Semiconductor reserves the right to make changes without further notice to any products herein. ON Semiconductor makes no warranty, representation or guarantee regarding the suitability of its products for any particular purpose, nor does ON Semiconductor assume any liability arising out of the application or use of any product or circuit, and specifically disclaims any and all liability, including without limitation special, consequential or incidental damages. ON Semiconductor does not convey any license under its patent rights nor the rights of others.

**onsemi**, **Onsemi**, and other names, marks, and brands are registered and/or common law trademarks of Semiconductor Components Industries, LLC dba "**onsemi**" or its affiliates and/or subsidiaries in the United States and/or other countries. **onsemi** owns the rights to a number of patents, trademarks, copyrights, trade secrets, and other intellectual property. A listing of **onsemi**'s product/patent coverage may be accessed at [www.onsemi.com/site/pdf/Patent-Marking.pdf](http://www.onsemi.com/site/pdf/Patent-Marking.pdf). **onsemi** reserves the right to make changes at any time to any products or information herein, without notice. The information herein is provided "as-is" and **onsemi** makes no warranty, representation or guarantee regarding the accuracy of the information, product features, availability, functionality, or suitability of its products for any particular purpose, nor does **onsemi** assume any liability arising out of the application or use of any product or circuit, and specifically disclaims any and all liability, including without limitation special, consequential or incidental damages. Buyer is responsible for its products and applications using **onsemi** products, including compliance with all laws, regulations and safety requirements or standards, regardless of any support or applications information provided by **onsemi**. "Typical" parameters which may be provided in **onsemi** data sheets and/or specifications can and do vary in different applications and actual performance may vary over time. All operating parameters, including "Typicals" must be validated for each customer application by customer's technical experts. **onsemi** does not convey any license under any of its intellectual property rights nor the rights of others. **onsemi** products are not designed, intended, or authorized for use as a critical component in life support systems or any FDA Class 3 medical devices or medical devices with a same or similar classification in a foreign jurisdiction or any devices intended for implantation in the human body. Should Buyer purchase or use **onsemi** products for any such unintended or unauthorized application, Buyer shall indemnify and hold **onsemi** and its officers, employees, subsidiaries, affiliates, and distributors harmless against all claims, costs, damages, and expenses, and reasonable attorney fees arising out of, directly or indirectly, any claim of personal injury or death associated with such unintended or unauthorized use, even if such claim alleges that **onsemi** was negligent regarding the design or manufacture of the part. **onsemi** is an Equal Opportunity/Affirmative Action Employer. This literature is subject to all applicable copyright laws and is not for resale in any manner.

## PUBLICATION ORDERING INFORMATION

### LITERATURE FULFILLMENT:

Email Requests to: [orderlit@onsemi.com](mailto:orderlit@onsemi.com)

**onsemi Website:** [www.onsemi.com](http://www.onsemi.com)

### TECHNICAL SUPPORT

**North American Technical Support:**

Voice Mail: 1 800-282-9855 Toll Free USA/Canada

Phone: 011 421 33 790 2910

**Europe, Middle East and Africa Technical Support:**

Phone: 00421 33 790 2910

For additional information, please contact your local Sales Representative

## X-ON Electronics

Largest Supplier of Electrical and Electronic Components

*Click to view similar products for [ESD Suppressors / TVS Diodes](#) category:*

*Click to view products by [ON Semiconductor](#) manufacturer:*

Other Similar products are found below :

[60KS200C](#) [D12V0H1U2WS-7](#) [D18V0L1B2LP-7B](#) [82356050220](#) [D5V0M5U6V-7](#) [NTE4902](#) [P4KE27CA](#) [P6KE11CA](#) [P6KE39CA-TP](#)  
[P6KE8.2A](#) [SA110CA](#) [SA60CA](#) [SA64CA](#) [SMBJ12CATR](#) [SMBJ8.0A](#) [SMLJ30CA-TP](#) [ESD101-B1-02ELS E6327](#) [ESD112-B1-02EL E6327](#)  
[ESD119B1W01005E6327XTSA1](#) [ESD5V0J4-TP](#) [ESD5V0L1B02VH6327XTSA1](#) [ESD7451N2T5G](#) [19180-510](#) [CPDT-5V0USP-HF](#)  
[3.0SMCJ33CA-F](#) [3.0SMCJ36A-F](#) [HSPC16701B02TP](#) [D3V3Q1B2DLP3-7](#) [D55V0M1B2WS-7](#) [DESD5V0U1BL-7B](#) [DRTR5V0U4SL-7](#)  
[SCM1293A-04SO](#) [ESD200-B1-CSP0201 E6327](#) [ESD203-B1-02EL E6327](#) [SM12-7](#) [SMF8.0A-TP](#) [SMLJ45CA-TP](#) [CEN955 W/DATA](#)  
[82350120560](#) [82356240030](#) [VESD12A1A-HD1-GS08](#) [CPDUR5V0R-HF](#) [CPDUR24V-HF](#) [CPDQC5V0U-HF](#) [CPDQC5V0USP-HF](#)  
[CPDQC5V0-HF](#) [D1213A-01LP4-7B](#) [D1213A-02WL-7](#) [ESDLIN1524BJ-HQ](#) [5KP100A](#)