

ESD8024

ESD Protection Diode

Low Capacitance ESD Protection Diode for High Speed Data Line

The ESD8024 surge protection is designed specifically to protect Low Voltage Differential Signals (LVDS) for LCD panels. Ultra-low capacitance and low ESD clamping voltage make this device an ideal solution for protecting voltage sensitive data lines. The integrated 24 lines of protection offers a simplified solution with premier performance for LVDS applications.

Features

- Full Function LVDS Solution
- 4 pF Max, I/O to GND
- Protection for the Following IEC Standards:
 - IEC 61000-4-2 (ESD) ± 8 kV (Contact)
 - IEC61000-4-5 (Lightning) 20 A (8/20 μ s)
- UL Flammability Rating of 94 V-0
- This is a Pb-Free Device

Typical Applications

- LVDS
- LCD Panel TCON

MAXIMUM RATINGS ($T_J = 25^\circ\text{C}$ unless otherwise noted)

Rating	Symbol	Value	Unit
Operating Junction Temperature Range	T_J	-55 to +125	$^\circ\text{C}$
Storage Temperature Range	T_{stg}	-55 to +150	$^\circ\text{C}$
Lead Solder Temperature - Maximum (10 Seconds)	T_L	260	$^\circ\text{C}$
IEC 61000-4-2 Contact (ESD)	ESD	± 30	kV
IEC 61000-4-2 Air (ESD)	ESD	± 30	kV
Maximum Peak Pulse Current 8/20 μ s @ $T_A = 25^\circ\text{C}$	I_{pp}	20	A

Stresses exceeding those listed in the Maximum Ratings table may damage the device. If any of these limits are exceeded, device functionality should not be assumed, damage may occur and reliability may be affected.



ON Semiconductor®

www.onsemi.com

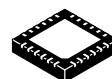

QFN24
CASE 485L

MARKING DIAGRAM

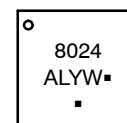

8024 = Specific Device Code
A = Assembly Location
L = Wafer Lot
Y = Year
W = Work Week
▪ = Pb-Free Package
(Note: Microdot may be in either location)

ORDERING INFORMATION

Device	Package	Shipping
ESD8024MNTAG	QFN24 (Pb-Free)	4000 / Tape & Reel

†For information on tape and reel specifications, including part orientation and tape sizes, please refer to our Tape and Reel Packaging Specification Brochure, BRD8011/D.

See Application Note AND8308/D for further description of survivability specs.

ESD8024

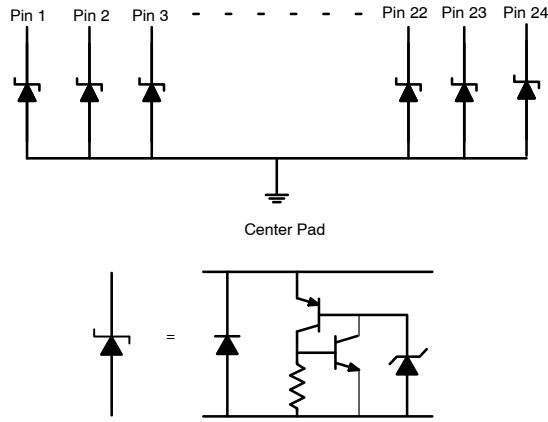
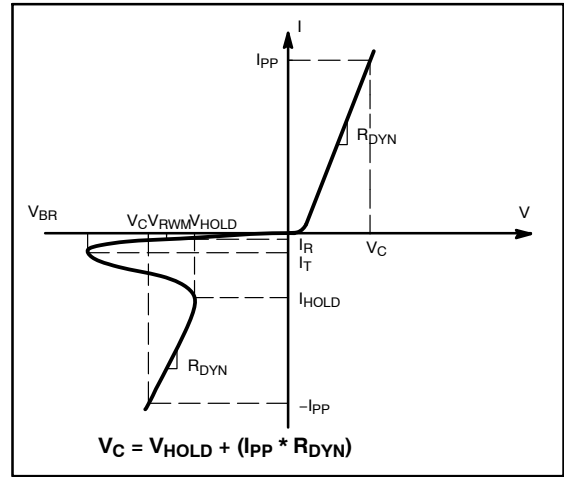

Figure 1. Pin Schematic

ELECTRICAL CHARACTERISTICS

($T_A = 25^\circ\text{C}$ unless otherwise noted)

Symbol	Parameter
V_{RWM}	Working Peak Voltage
I_R	Maximum Reverse Leakage Current @ V_{RWM}
V_{BR}	Breakdown Voltage @ I_T
I_T	Test Current
V_{HOLD}	Holding Reverse Voltage
I_{HOLD}	Holding Reverse Current
R_{DYN}	Dynamic Resistance
I_{PP}	Maximum Peak Pulse Current
V_C	Clamping Voltage @ I_{PP} $V_C = V_{HOLD} + (I_{PP} * R_{DYN})$



ELECTRICAL CHARACTERISTICS ($T_A = 25^\circ\text{C}$ unless otherwise specified)

Parameter	Symbol	Conditions	Min	Typ	Max	Unit
Reverse Working Voltage	V_{RWM}	All Pins (1-24) to GND (Note 1)			2.5	V
Forward Voltage	V_F	$I_F = 10 \text{ mA}$, GND to All Pins (1-24)	0.5	0.85	1.1	V
Breakdown Voltage	V_{BR}	$I_T = 1 \text{ mA}$, All Pins (1-24) to GND	5.5	7.0	9.0	V
Reverse Leakage Current	I_R	$V_{RWM} = 2.5 \text{ V}$, All Pins (1-24) to GND			0.5	μA
Holding Reverse Voltage	V_{HOLD}	I/O Pin to GND	1	1.5		V
Holding Reverse Current	I_{HOLD}	I/O Pin to GND		50		mA
Clamping Voltage	V_C	$I_{PP} = 1 \text{ A}$, All Pins (1-24) to GND (8/20 μs pulse)			4.0	V
Clamping Voltage	V_C	$I_{PP} = 10 \text{ A}$, All Pins (1-24) to GND (8/20 μs pulse)			7.0	V
Clamping Voltage	V_C	$I_{PP} = 15 \text{ A}$, All Pins (1-24) to GND (8/20 μs pulse)			8.0	V
Clamping Voltage	V_C	IEC61000-4-2, $\pm 8 \text{ kV}$ Contact	See Figures 2 and 3			V
Junction Capacitance	C_J	$V_R = 0 \text{ V}$, $f = 1 \text{ MHz}$ between I/O Pins			2.0	pF
Junction Capacitance	C_J	$V_R = 0 \text{ V}$, $f = 1 \text{ MHz}$ between I/O Pins and GND			4.0	pF

1. Surge protection devices are normally selected according to the working peak reverse voltage (V_{RWM}), which should be equal or greater than the DC or continuous peak operating voltage level.

TYPICAL CHARACTERISTICS

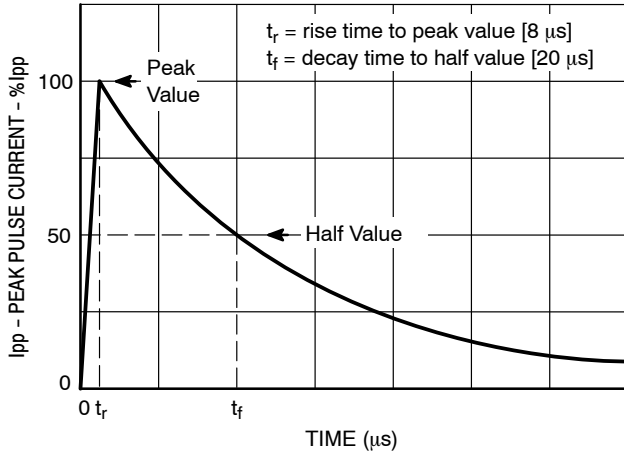

Figure 2. IEC61000-4-5 8/20 μ s Pulse Waveform

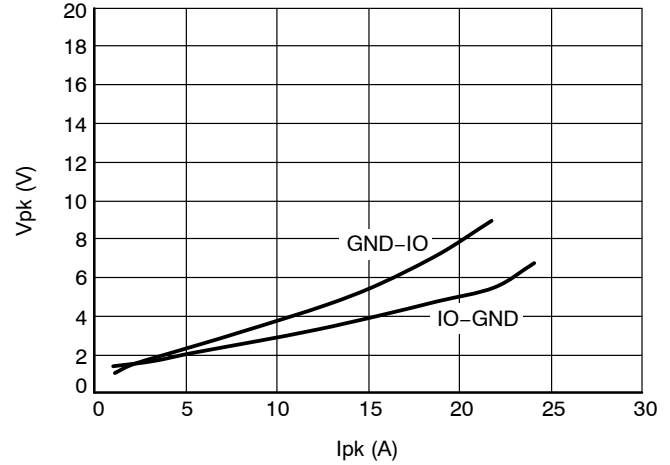

Figure 3. Clamping Voltage vs. Peak Pulse Current ($t_p = 8/20 \mu$ s per Figure 2)

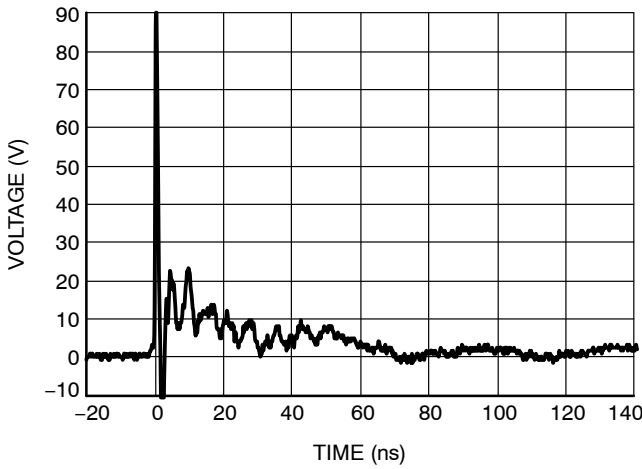

Figure 4. IEC61000-4-2 + 8 kV Contact Clamping Voltage

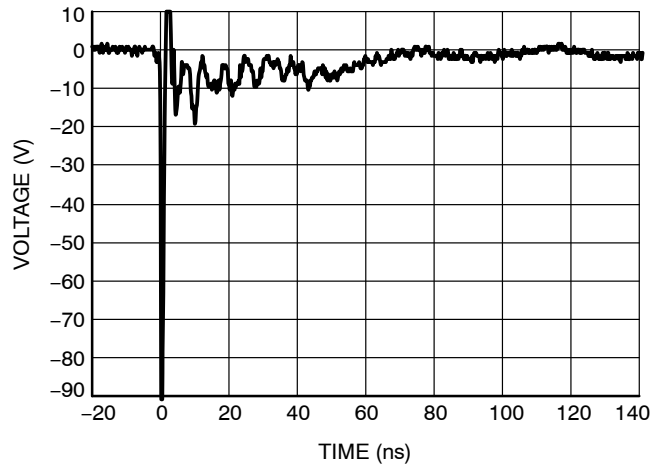

Figure 5. IEC61000-4-2 - 8 kV Contact Clamping Voltage

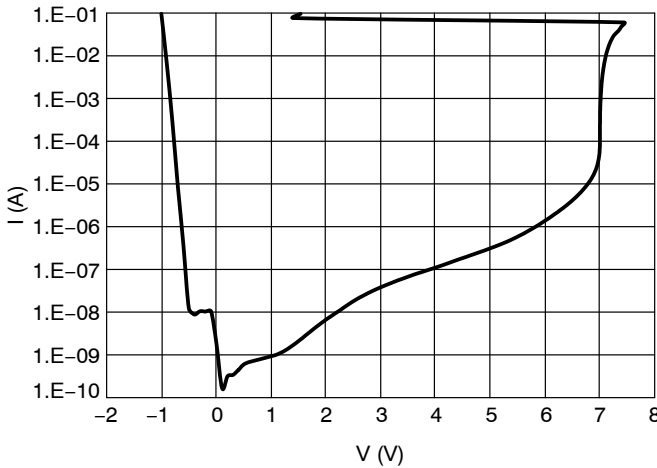

Figure 6. IV Characteristics

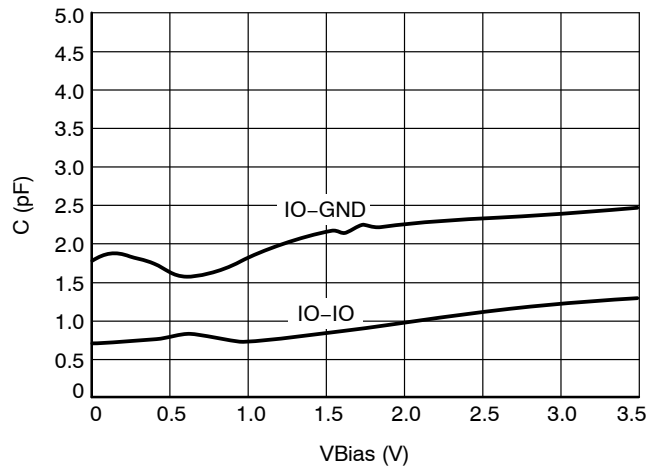

Figure 7. CV Characteristics

ESD8024

TYPICAL CHARACTERISTICS

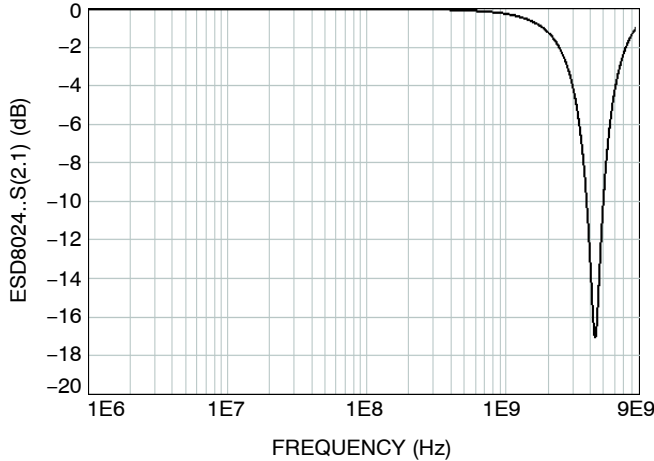

Figure 8. RF Insertion Loss

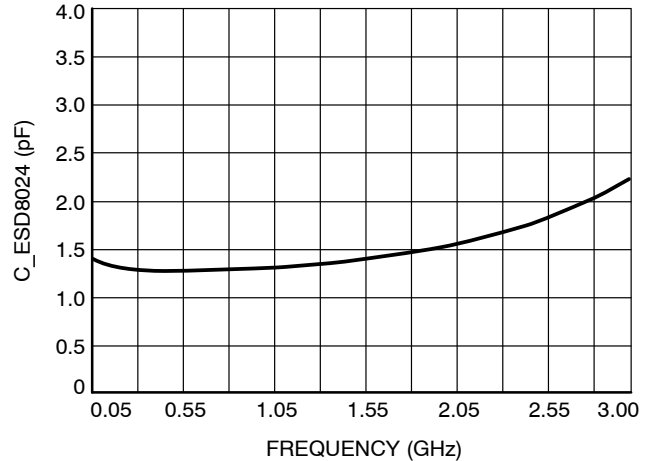

Figure 9. Capacitance over Frequency

PCB Layout Guidelines

Steps must be taken for proper placement and signal trace routing of the protection device in order to ensure the maximum survivability and signal integrity for the application. Such steps are listed below.

- Place the protection device as close as possible to the I/O connector to reduce the transient path to ground and improve the protection performance.
 - ◆ Consequently, place the device under protection as far as possible from the protection device to help further improve protection performance.
- Keep trace lengths connecting protection device pins to data lines as short as possible. These “stub” traces, if long enough, can create voltage drops that impede the turn-on of the protection device.
- Make sure to use differential design methodology and impedance matching of all high speed signal traces.
 - ◆ Use curved traces when possible to avoid unwanted reflections.
 - ◆ Keep the trace lengths equal between the positive and negative lines of the differential data lanes to avoid common mode noise generation and impedance mismatch.

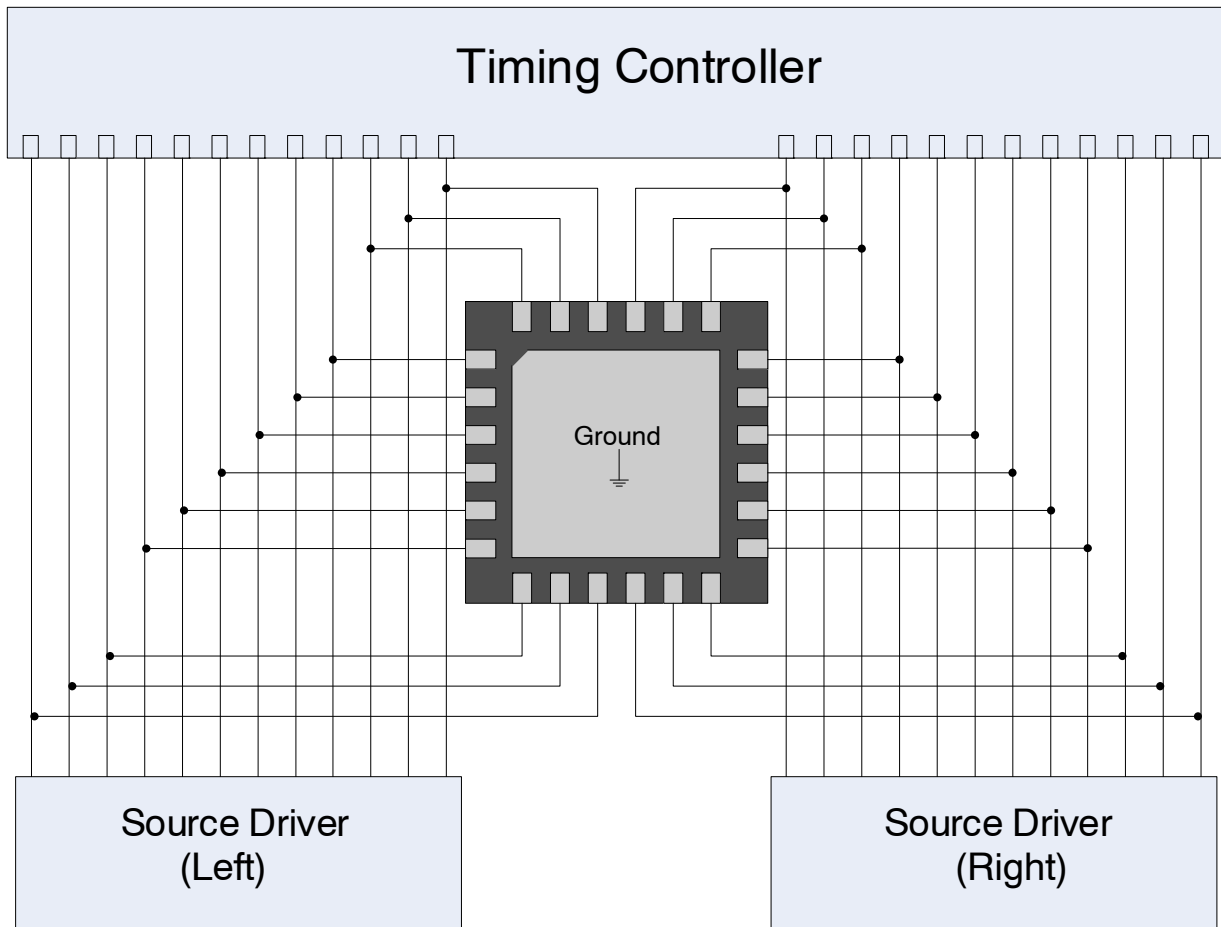

Figure 10. Board Routing Diagram – TCON LVDS Interface

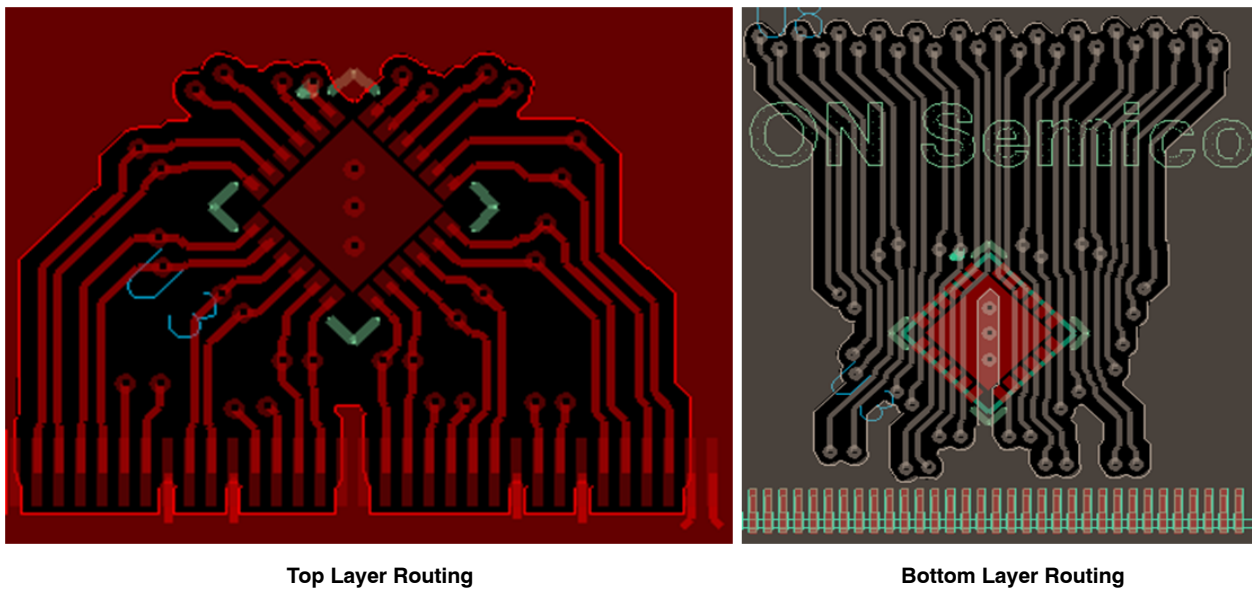
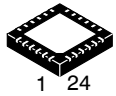

Figure 11. ESD8024 Recommended PCB Layout

MECHANICAL CASE OUTLINE

PACKAGE DIMENSIONS

ON Semiconductor®



1 24

SCALE 2:1

QFN24, 4x4, 0.5P
CASE 485L
ISSUE B

DATE 05 JUN 2012

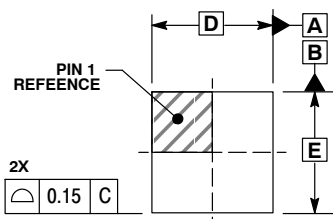

TOP VIEW

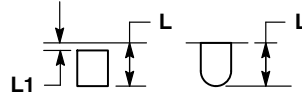

DETAIL A
ALTERNATE
CONSTRUCTIONS

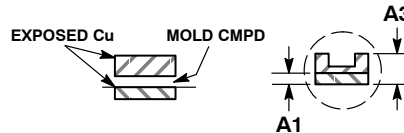

DETAIL B
ALTERNATE TERMINAL
CONSTRUCTIONS

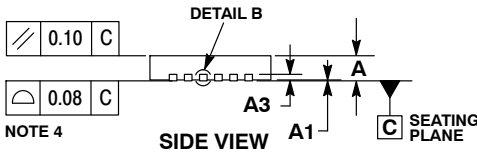

SIDE VIEW

NOTE 4

NOTES:

- DIMENSIONING AND TOLERANCING PER ASME Y14.5M, 1994.
- CONTROLLING DIMENSION: MILLIMETERS.
- DIMENSION b APPLIES TO PLATED TERMINAL AND IS MEASURED BETWEEN 0.25 AND 0.30 MM FROM THE TERMINAL TIP.
- COPLANARITY APPLIES TO THE EXPOSED PAD AS WELL AS THE TERMINALS.

DIM	MILLIMETERS	
	MIN	MAX
A	0.80	1.00
A1	0.00	0.05
A3	0.20	REF
b	0.20	0.30
D	4.00	BSC
D2	2.70	2.90
E	4.00	BSC
E2	2.70	2.90
e	0.50	BSC
L	0.30	0.50
L1	0.05	0.15

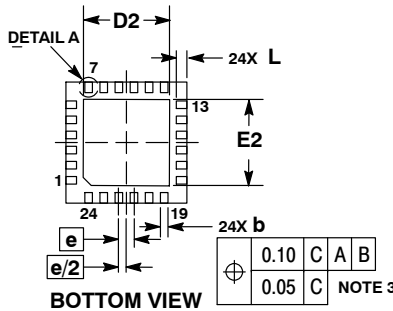

BOTTOM VIEW

0.10	C	A	B
0.05	C	NOTE 3	

GENERIC MARKING DIAGRAM*

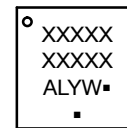

- XXXXX = Specific Device Code
- A = Assembly Location
- L = Wafer Lot
- Y = Year
- W = Work Week
- = Pb-Free Package

(Note: Microdot may be in either location)

*This information is generic. Please refer to device data sheet for actual part marking. Pb-Free indicator, "G" or microdot "▪", may or may not be present.

RECOMMENDED SOLDERING FOOTPRINT

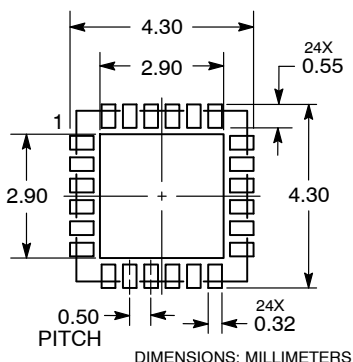

DIMENSIONS: MILLIMETERS

DOCUMENT NUMBER:	98AON11783D	Electronic versions are uncontrolled except when accessed directly from the Document Repository. Printed versions are uncontrolled except when stamped "CONTROLLED COPY" in red.
DESCRIPTION:	QFN24, 4X4, 0.5P	PAGE 1 OF 1

ON Semiconductor and ON are trademarks of Semiconductor Components Industries, LLC dba ON Semiconductor or its subsidiaries in the United States and/or other countries. ON Semiconductor reserves the right to make changes without further notice to any products herein. ON Semiconductor makes no warranty, representation or guarantee regarding the suitability of its products for any particular purpose, nor does ON Semiconductor assume any liability arising out of the application or use of any product or circuit, and specifically disclaims any and all liability, including without limitation special, consequential or incidental damages. ON Semiconductor does not convey any license under its patent rights nor the rights of others.

onsemi, **Onsemi**, and other names, marks, and brands are registered and/or common law trademarks of Semiconductor Components Industries, LLC dba "**onsemi**" or its affiliates and/or subsidiaries in the United States and/or other countries. **onsemi** owns the rights to a number of patents, trademarks, copyrights, trade secrets, and other intellectual property. A listing of **onsemi**'s product/patent coverage may be accessed at www.onsemi.com/site/pdf/Patent-Marking.pdf. **onsemi** reserves the right to make changes at any time to any products or information herein, without notice. The information herein is provided "as-is" and **onsemi** makes no warranty, representation or guarantee regarding the accuracy of the information, product features, availability, functionality, or suitability of its products for any particular purpose, nor does **onsemi** assume any liability arising out of the application or use of any product or circuit, and specifically disclaims any and all liability, including without limitation special, consequential or incidental damages. Buyer is responsible for its products and applications using **onsemi** products, including compliance with all laws, regulations and safety requirements or standards, regardless of any support or applications information provided by **onsemi**. "Typical" parameters which may be provided in **onsemi** data sheets and/or specifications can and do vary in different applications and actual performance may vary over time. All operating parameters, including "Typicals" must be validated for each customer application by customer's technical experts. **onsemi** does not convey any license under any of its intellectual property rights nor the rights of others. **onsemi** products are not designed, intended, or authorized for use as a critical component in life support systems or any FDA Class 3 medical devices or medical devices with a same or similar classification in a foreign jurisdiction or any devices intended for implantation in the human body. Should Buyer purchase or use **onsemi** products for any such unintended or unauthorized application, Buyer shall indemnify and hold **onsemi** and its officers, employees, subsidiaries, affiliates, and distributors harmless against all claims, costs, damages, and expenses, and reasonable attorney fees arising out of, directly or indirectly, any claim of personal injury or death associated with such unintended or unauthorized use, even if such claim alleges that **onsemi** was negligent regarding the design or manufacture of the part. **onsemi** is an Equal Opportunity/Affirmative Action Employer. This literature is subject to all applicable copyright laws and is not for resale in any manner.

PUBLICATION ORDERING INFORMATION

LITERATURE FULFILLMENT:

Email Requests to: orderlit@onsemi.com

onsemi Website: www.onsemi.com

TECHNICAL SUPPORT

North American Technical Support:

Voice Mail: 1 800-282-9855 Toll Free USA/Canada

Phone: 011 421 33 790 2910

Europe, Middle East and Africa Technical Support:

Phone: 00421 33 790 2910

For additional information, please contact your local Sales Representative

X-ON Electronics

Largest Supplier of Electrical and Electronic Components

Click to view similar products for [ESD Suppressors / TVS Diodes](#) category:

Click to view products by [ON Semiconductor](#) manufacturer:

Other Similar products are found below :

[60KS200C](#) [D12V0H1U2WS-7](#) [D18V0L1B2LP-7B](#) [82356050220](#) [D5V0M5U6V-7](#) [NTE4902](#) [P4KE27CA](#) [P6KE11CA](#) [P6KE39CA-TP](#)
[P6KE8.2A](#) [SA110CA](#) [SA60CA](#) [SA64CA](#) [SMBJ12CATR](#) [SMBJ8.0A](#) [SMLJ30CA-TP](#) [ESD101-B1-02ELS E6327](#) [ESD112-B1-02EL E6327](#)
[ESD119B1W01005E6327XTSA1](#) [ESD5V0J4-TP](#) [ESD5V0L1B02VH6327XTSA1](#) [ESD7451N2T5G](#) [19180-510](#) [CPDT-5V0USP-HF](#)
[3.0SMCJ33CA-F](#) [3.0SMCJ36A-F](#) [HSPC16701B02TP](#) [D3V3Q1B2DLP3-7](#) [D55V0M1B2WS-7](#) [DESD5V0U1BL-7B](#) [DRTR5V0U4SL-7](#)
[SCM1293A-04SO](#) [ESD200-B1-CSP0201 E6327](#) [ESD203-B1-02EL E6327](#) [SM12-7](#) [SMF8.0A-TP](#) [SMLJ45CA-TP](#) [CEN955 W/DATA](#)
[82350120560](#) [82356240030](#) [VESD12A1A-HD1-GS08](#) [CPDUR5V0R-HF](#) [CPDUR24V-HF](#) [CPDQC5V0U-HF](#) [CPDQC5V0USP-HF](#)
[CPDQC5V0-HF](#) [D1213A-01LP4-7B](#) [D1213A-02WL-7](#) [ESDLIN1524BJ-HQ](#) [5KP100A](#)