

# ESD8040

## ESD Protection Diode

### Low Capacitance Array for High Speed Video Interfaces

The ESD8040 is designed specifically to protect HDMI and Display Port Interfaces with full functionality ESD protection and back drive current protection for V<sub>CC</sub> line. Ultra-low capacitance and low ESD clamping voltage make this device an ideal solution for protecting voltage sensitive high speed data lines. The flow-through style package allows for easy PCB layout and matched trace lengths necessary to maintain consistent impedance for the high speed TMDS lines.

#### Features

- Full Function HDMI / Display Port Solution
- Single Connect, Flow through Routing for TMDS Lines
- Low Capacitance (0.35 pF Max, I/O to GND)
- Protection for the Following IEC Standards:  
IEC 61000-4-2 Level 4
- UL Flammability Rating of 94 V-0
- This is a Pb-Free Device

#### Typical Applications

- HDMI 1.3/1.4/2.0
- Display Port

#### MAXIMUM RATINGS (T<sub>J</sub> = 25°C unless otherwise noted)

Rating	Symbol	Value	Unit
Operating Junction Temperature Range	T <sub>J</sub>	-55 to +125	°C
Storage Temperature Range	T <sub>stg</sub>	-55 to +150	°C
Lead Solder Temperature - Maximum (10 Seconds)	T <sub>L</sub>	260	°C
IEC 61000-4-2 Contact (ESD)	ESD	±15	kV
IEC 61000-4-2 Air (ESD)	ESD	±15	kV

Stresses exceeding those listed in the Maximum Ratings table may damage the device. If any of these limits are exceeded, device functionality should not be assumed, damage may occur and reliability may be affected.

See Application Note AND8308/D for further description of survivability specs.



ON Semiconductor®

[www.onsemi.com](http://www.onsemi.com)

#### MARKING DIAGRAM



8040 = Specific Device Code  
M = Date Code  
▪ = Pb-Free Package

(Note: Microdot may be in either location)

#### ORDERING INFORMATION

Device	Package	Shipping
ESD8040MUTAG	UDFN18 (Pb-Free)	3000 / Tape & Reel

†For information on tape and reel specifications, including part orientation and tape sizes, please refer to our Tape and Reel Packaging Specification Brochure, BRD8011/D.

# ESD8040

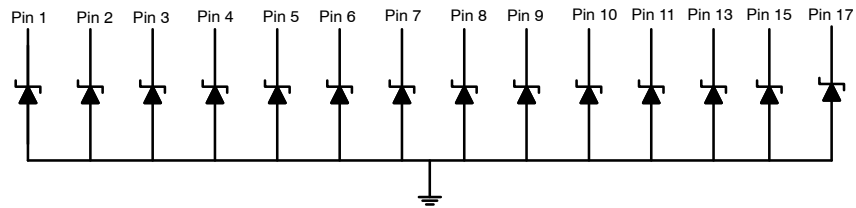

Center Pins, Pin 12, 14, 16, 18

Note: Common GND – Only minimum of 1 GND connection required

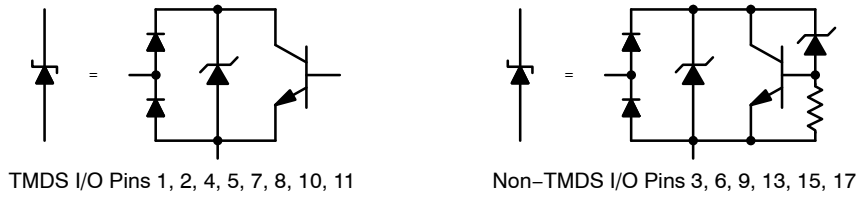

**Figure 1. Pin Schematic**

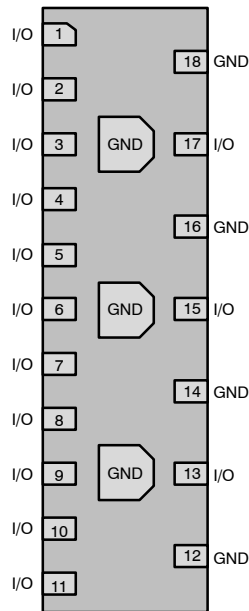

**Figure 2. Pin Configuration**

Note: Pins 12, 14, 16, 18 and center pins are connected internally as a common ground.  
Only minimum of one pin needs to be connected to ground for functionality of all pins.

# ESD8040

## ELECTRICAL CHARACTERISTICS

( $T_A = 25^\circ\text{C}$  unless otherwise noted)

Symbol	Parameter
$I_{PP}$	Maximum Peak Pulse Current
$V_C$	Clamping Voltage @ $I_{PP}$
$V_{RWM}$	Working Peak Reverse Voltage
$I_R$	Maximum Reverse Leakage Current @ $V_{RWM}$
$V_{BR}$	Breakdown Voltage @ $I_T$
$I_T$	Test Current
$R_{DYN}$	Dynamic Resistance

\*See Application Note AND8308/D for detailed explanations of datasheet parameters.

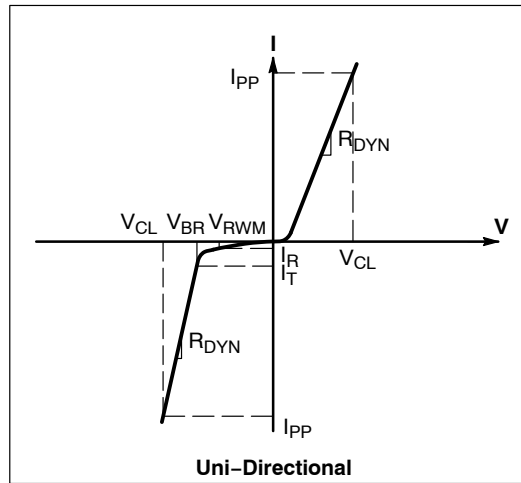

## ELECTRICAL CHARACTERISTICS ( $T_A = 25^\circ\text{C}$ unless otherwise specified)

Parameter	Symbol	Conditions	Min	Typ	Max	Unit
Reverse Working Voltage	$V_{RWM}$	I/O Pin to GND			3.3	V
Breakdown Voltage	$V_{BR}$	$I_T = 1\text{ mA}$ , I/O Pins 1, 2, 4, 5, 7, 8, 10, 11 to GND $I_T = 1\text{ mA}$ , I/O Pins 3, 6, 9, 13, 15, 17 to GND	4.0 5.5	5.5 6.5		V
Reverse Leakage Current	$I_R$	$V_{RWM} = 3.3\text{ V}$ , I/O Pin to GND			1.0	$\mu\text{A}$
Clamping Voltage (Note 1)	$V_C$	IEC61000-4-2, $\pm 8\text{ kV}$ Contact	See Figures 3 and 4			V
Clamping Voltage TLP (Note 2) See Figures 9 through 12	$V_C$	$I_{PP} = 8\text{ A}$ $I_{PP} = -8\text{ A}$ } IEC 61000-4-2 Level 2 equivalent ( $\pm 4\text{ kV}$ Contact, $\pm 4\text{ kV}$ Air) $I_{PP} = 16\text{ A}$ $I_{PP} = -16\text{ A}$ } IEC 61000-4-2 Level 4 equivalent ( $\pm 8\text{ kV}$ Contact, $\pm 15\text{ kV}$ Air)		9.2 -4.5		V
Dynamic Resistance	$R_{DYN}$	I/O Pin to GND GND to I/O Pin		0.33 0.45		$\Omega$
Junction Capacitance	$C_J$	$V_R = 0\text{ V}$ , $f = 1\text{ MHz}$ between I/O Pins and GND		0.30	0.35	pF

- For test procedure see Figures 7 and 8 and application note AND8307/D.
- ANSI/ESD STM5.5.1 – Electrostatic Discharge Sensitivity Testing using Transmission Line Pulse (TLP) Model.  
TLP conditions:  $Z_0 = 50\ \Omega$ ,  $t_p = 100\text{ ns}$ ,  $t_r = 4\text{ ns}$ , averaging window;  $t_1 = 30\text{ ns}$  to  $t_2 = 60\text{ ns}$ .

Product parametric performance is indicated in the Electrical Characteristics for the listed test conditions, unless otherwise noted. Product performance may not be indicated by the Electrical Characteristics if operated under different conditions.

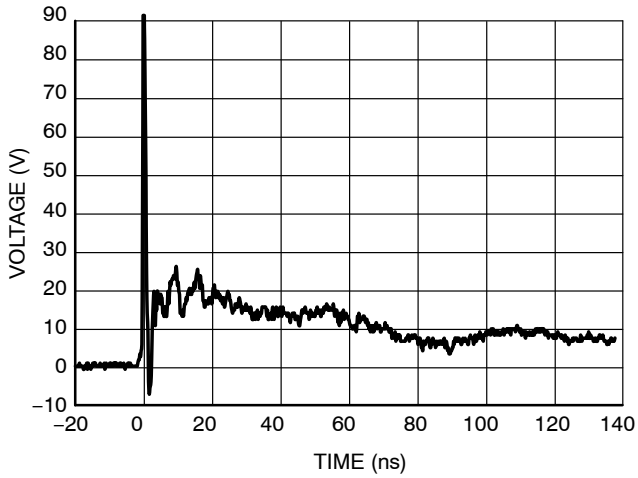

**Figure 3. IEC61000-4-2 +8 kV Contact Clamping Voltage (TMS I/O Pins)**

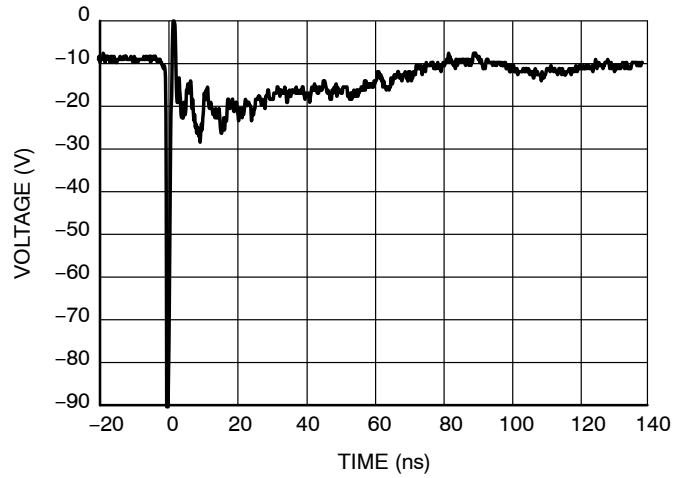

**Figure 4. IEC61000-4-2 -8 kV Contact Clamping Voltage (TMS I/O Pins)**

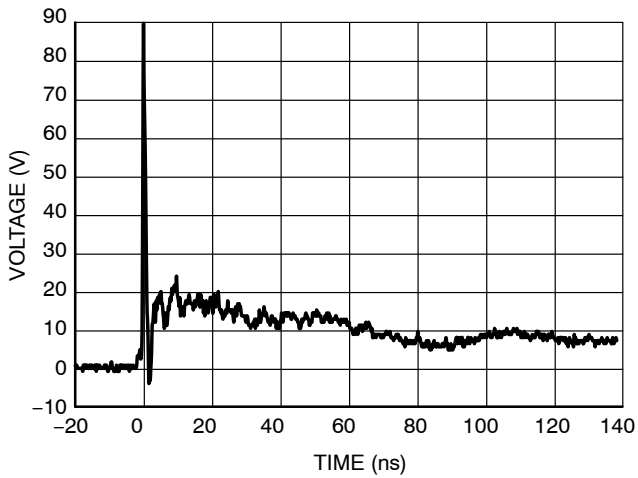

**Figure 5. IEC61000-4-2 +8 kV Contact Clamping Voltage (Non-TMS I/O Pins)**

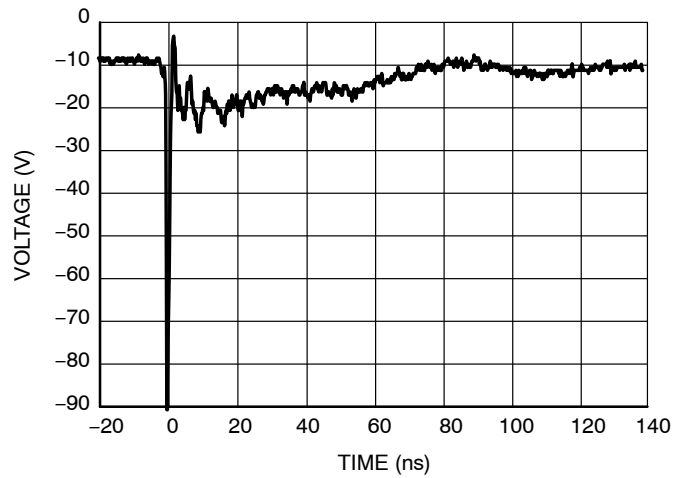

**Figure 6. IEC61000-4-2 -8 kV Contact Clamping Voltage (Non-TMS I/O Pins)**

# ESD8040

## IEC 61000-4-2 Spec.

Level	Test Voltage (kV)	First Peak Current (A)	Current at 30 ns (A)	Current at 60 ns (A)
1	2	7.5	4	2
2	4	15	8	4
3	6	22.5	12	6
4	8	30	16	8

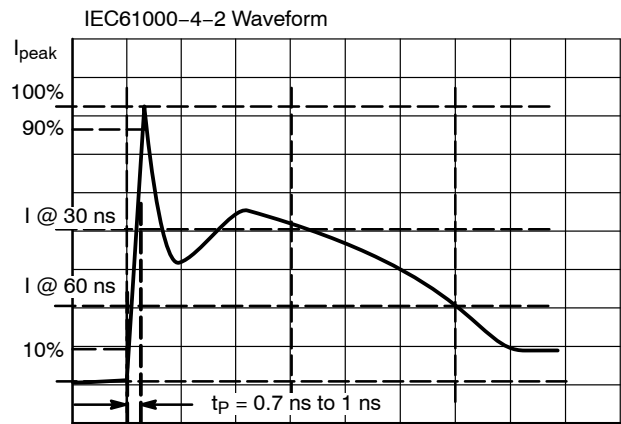

Figure 7. IEC61000-4-2 Spec

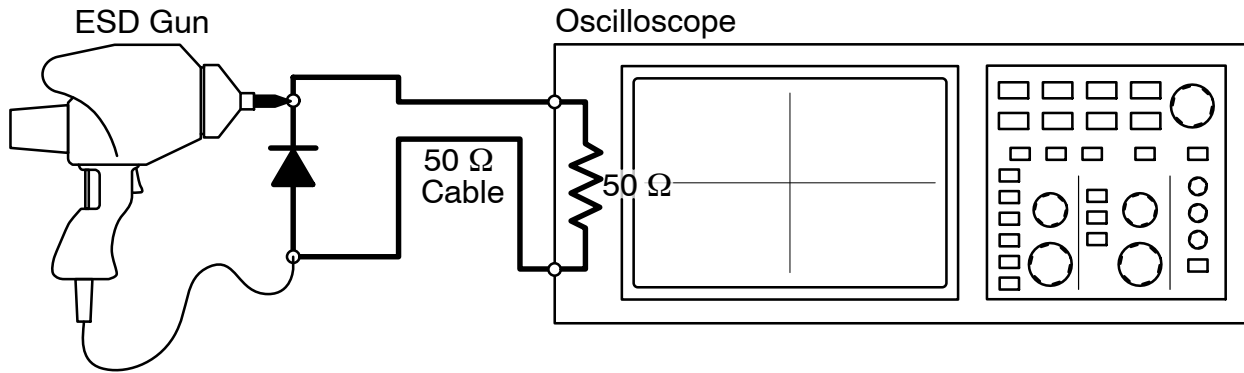

Figure 8. Diagram of ESD Clamping Voltage Test Setup

The following is taken from Application Note AND8308/D – Interpretation of Datasheet Parameters for ESD Devices.

### ESD Voltage Clamping

For sensitive circuit elements it is important to limit the voltage that an IC will be exposed to during an ESD event to as low a voltage as possible. The ESD clamping voltage is the voltage drop across the ESD protection diode during an ESD event per the IEC61000-4-2 waveform. Since the IEC61000-4-2 was written as a pass/fail spec for larger

systems such as cell phones or laptop computers it is not clearly defined in the spec how to specify a clamping voltage at the device level. ON Semiconductor has developed a way to examine the entire voltage waveform across the ESD protection diode over the time domain of an ESD pulse in the form of an oscilloscope screenshot, which can be found on the datasheets for all ESD protection diodes. For more information on how ON Semiconductor creates these screenshots and how to interpret them please refer to AND8307/D.

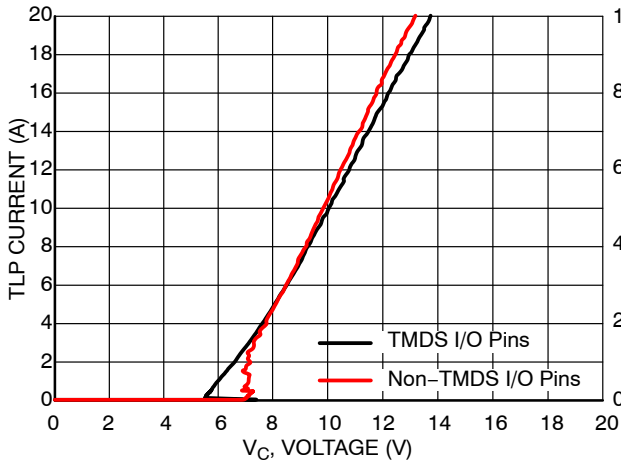

Figure 9. Positive TLP I-V Curve

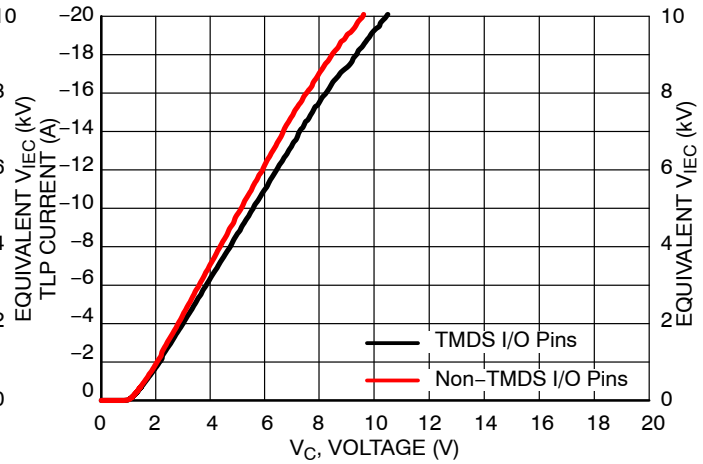

Figure 10. Negative TLP I-V Curve

NOTE: TLP parameter:  $Z_0 = 50 \Omega$ ,  $t_p = 100 \text{ ns}$ ,  $t_r = 300 \text{ ps}$ , averaging window:  $t_1 = 30 \text{ ns}$  to  $t_2 = 60 \text{ ns}$ .  $V_{IEC}$  is the equivalent voltage stress level calculated at the secondary peak of the IEC 61000-4-2 waveform at  $t = 30 \text{ ns}$  with  $2 \text{ A/kV}$ . See TLP description below for more information.

**Transmission Line Pulse (TLP) Measurement**

Transmission Line Pulse (TLP) provides current versus voltage (I-V) curves in which each data point is obtained from a 100 ns long rectangular pulse from a charged transmission line. A simplified schematic of a typical TLP system is shown in Figure 11. TLP I-V curves of ESD protection devices accurately demonstrate the product's ESD capability because the 10s of amps current levels and under 100 ns time scale match those of an ESD event. This is illustrated in Figure 12 where an 8 kV IEC 61000-4-2 current waveform is compared with TLP current pulses at 8 A and 16 A. A TLP I-V curve shows the voltage at which the device turns on as well as how well the device clamps voltage over a range of current levels. For more information on TLP measurements and how to interpret them please refer to AND9007/D.

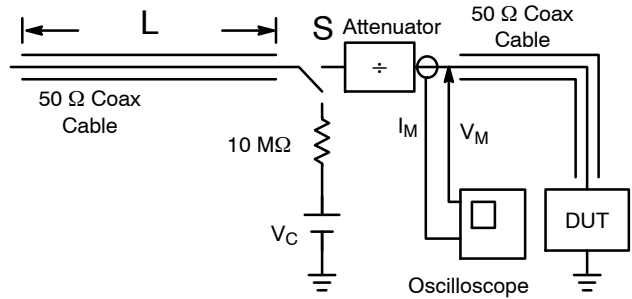

Figure 11. Simplified Schematic of a Typical TLP System

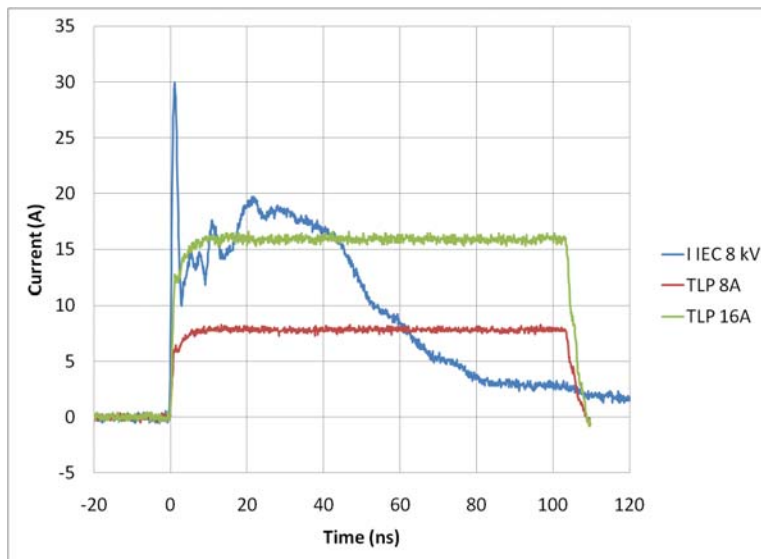
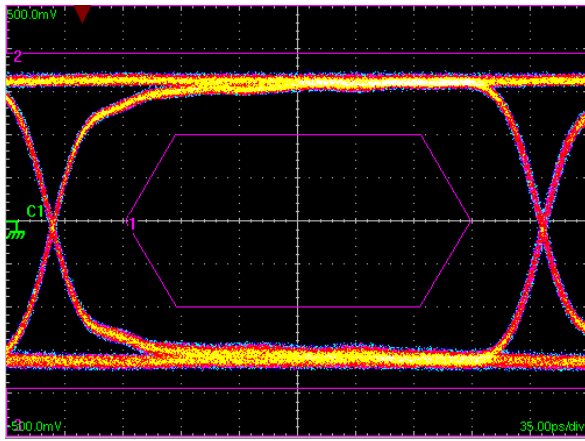
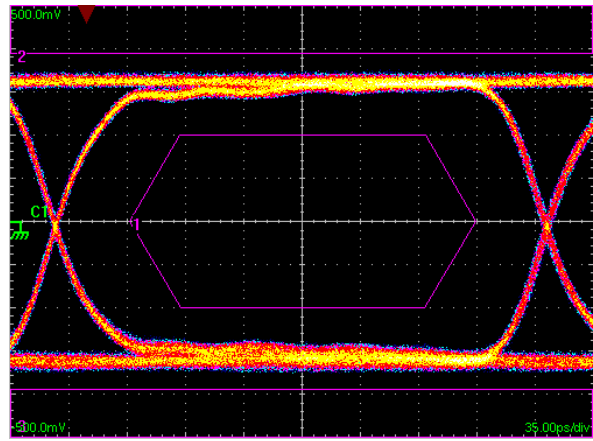

Figure 12. Comparison Between 8 kV IEC 61000-4-2 and 8 A and 16 A TLP Waveforms

# ESD8040



Without ESD8040



With ESD8040

Figure 13. HDMI 1.3/1.4 Eye Diagram with and without ESD8040. 3.4 Gb/s

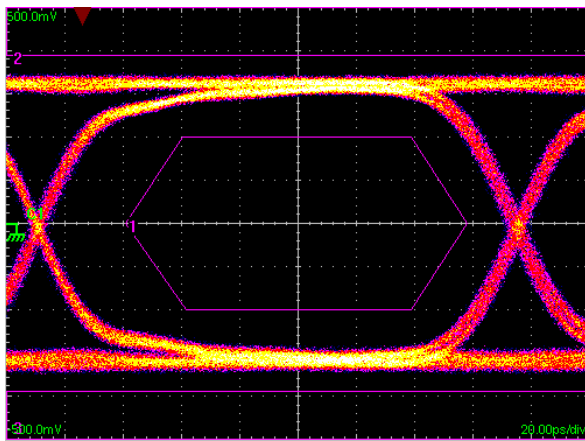

Without ESD8040

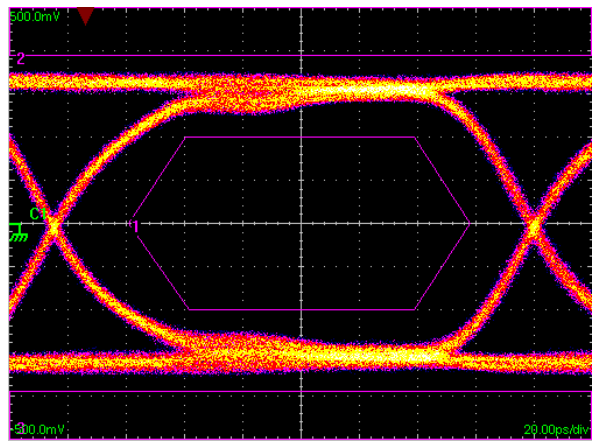

With ESD8040

Figure 14. HDMI 2.0 Eye Diagram with and without ESD8040. 6.0 Gb/s

See application note AND9075/D for further description of eye diagram testing methodology.

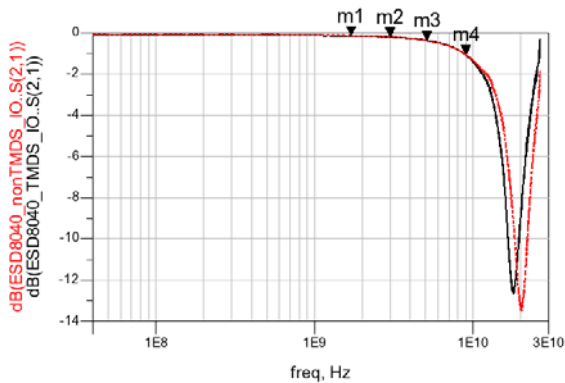

Figure 15. RF Insertion Loss

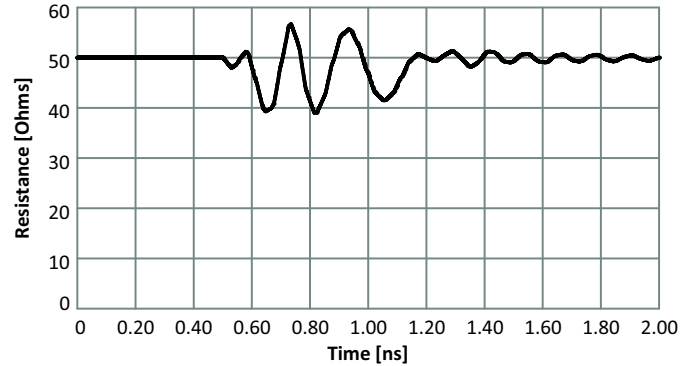
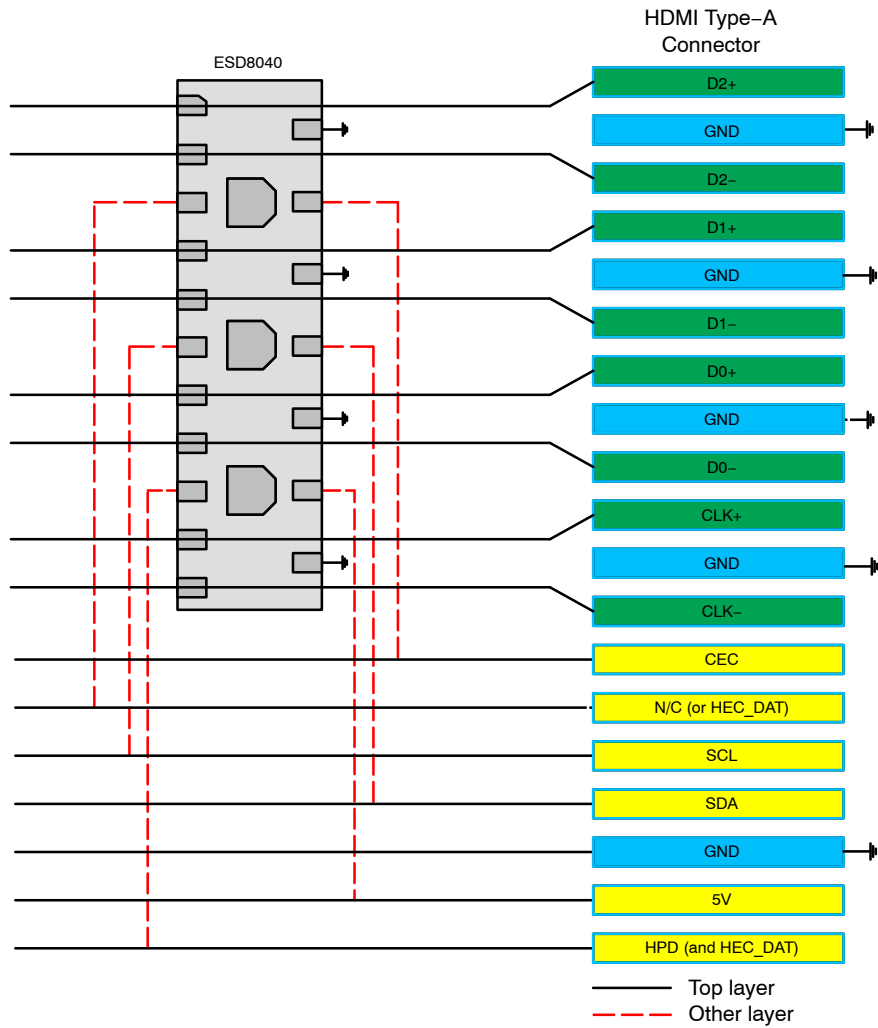

Figure 16. TDR – ESD8040

Table 1. RF Insertion Loss: Application Description

Interface	Data Rate (Gb/s)	Fundamental Frequency (GHz)	3 <sup>rd</sup> Harmonic Frequency (GHz)	ESD8040 Insertion LossJ(dB)
HDMI 1.3/1.4	3.4	1.7 (m1)	5.1 (m3)	m1 = 0.144 m2 = 0.203 m3 = 0.369 m4 = 1.067
HDMI 2.0	6.0	3.0 (m2)	9.0 (m4)	

# ESD8040



**Figure 17. HDMI Layout Diagram**

### Pin Description

I/O pins 1, 2, 4, 5, 7, 8, 10, and 11 are to be used for high speed differential TMDS lines whereas I/O pins 3, 6, 9, 13, 15, and 17 are to be used for lower speed lines (I<sup>2</sup>C, CEC, HPD, etc.). The ESD8040 was designed specifically for the HDMI application. The I/O pins for TMDS lines have a lower breakdown voltage and faster turn-on in the low

current region in order to better protect the sensitive low voltage, high-speed TMDS signals. The I/O pins for lower speed lines have a higher breakdown voltage to accommodate the higher voltages associated with the HPD, CEC, I<sup>2</sup>C and V<sub>CC</sub> lines as well as the optional Ethernet pin that can be implemented in HDMI1.4/2.0 applications.



**ESD Protection Device Technology**

- Low voltage punch through (LVPT): The key advantage for this technology is a very low turn-on voltage as shown in Figure 19. This technology provides optimized protection for chipsets with small geometries against recoverable failures due to voltage peaks (also known as “soft failures”).

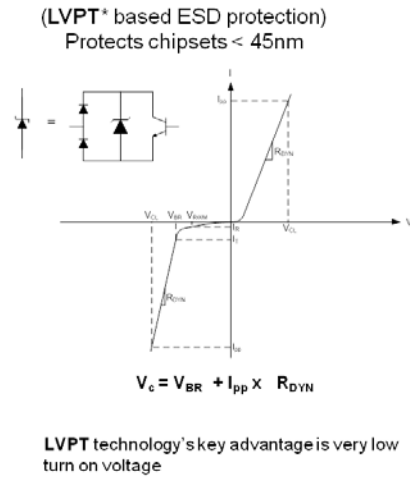

**Figure 18. LVPT Operation Description**

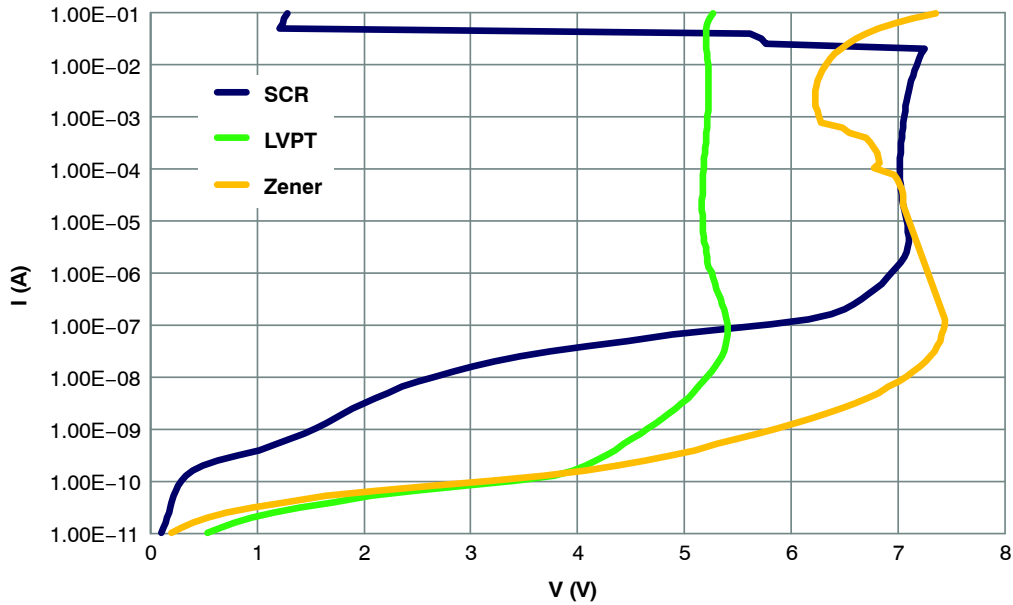

**Figure 19. Low Current, DC, IV Characteristic Technology Comparison**

# MECHANICAL CASE OUTLINE

## PACKAGE DIMENSIONS

ON Semiconductor®



### UDFN18, 5.5x1.5, 0.5P/0.75P CASE 517CP ISSUE A

DATE 07 FEB 2013

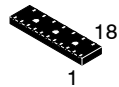

SCALE 2:1

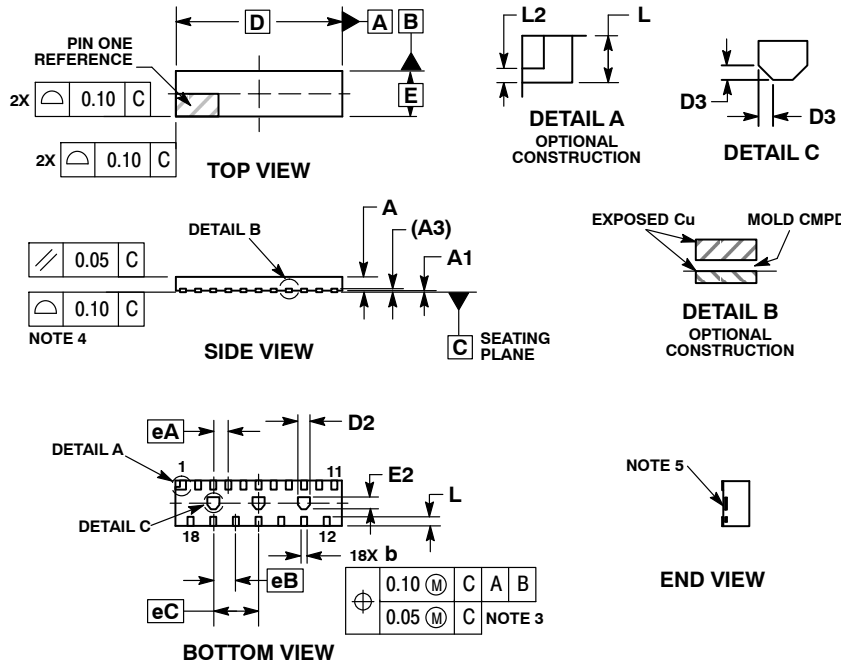

NOTES:

1. DIMENSIONING AND TOLERANCING PER ASME Y14.5M, 1994.
2. CONTROLLING DIMENSION: MILLIMETERS.
3. DIMENSION b APPLIES TO PLATED TERMINAL AND IS MEASURED BETWEEN 0.10 AND 0.20 MM FROM TERMINAL TIP.
4. COPLANARITY APPLIES TO THE EXPOSED PAD AS WELL AS THE TERMINALS.
5. EXPOSED ENDS OF TERMINALS ARE ELECTRICALLY ACTIVE.

DIM	MILLIMETERS	
	MIN	MAX
A	0.45	0.55
A1	0.00	0.05
A3	0.13 REF	
b	0.15	0.25
D	5.50 BSC	
D2	0.35	0.45
D3	0.10 REF	
E	1.50 BSC	
E2	0.35	0.45
eA	0.50 BSC	
eB	0.75 BSC	
eC	1.50 BSC	
L	0.20	0.40
L2	0.10 REF	

### GENERIC MARKING DIAGRAM\*

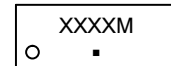

- XXXX = Specific Device Code
- M = Date Code
- = Pb-Free Package

\*This information is generic. Please refer to device data sheet for actual part marking.

### RECOMMENDED SOLDERING FOOTPRINT\*

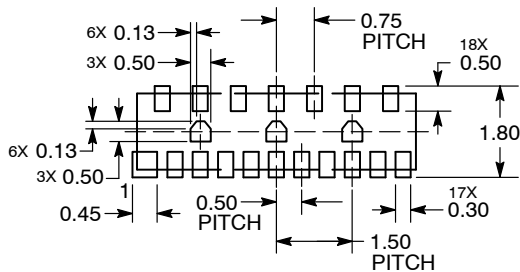

NOTE: CENTER PADS OPTIONAL DIMENSION: MILLIMETERS

\*For additional information on our Pb-Free strategy and soldering details, please download the ON Semiconductor Soldering and Mounting Techniques Reference Manual, SOLDERRM/D.

<b>DOCUMENT NUMBER:</b>	<b>98AON84709E</b>	Electronic versions are uncontrolled except when accessed directly from the Document Repository. Printed versions are uncontrolled except when stamped "CONTROLLED COPY" in red.
<b>DESCRIPTION:</b>	<b>UDFN18, 5.5X1.5, 0.5P/0.75P</b>	<b>PAGE 1 OF 1</b>

ON Semiconductor and ON are trademarks of Semiconductor Components Industries, LLC dba ON Semiconductor or its subsidiaries in the United States and/or other countries. ON Semiconductor reserves the right to make changes without further notice to any products herein. ON Semiconductor makes no warranty, representation or guarantee regarding the suitability of its products for any particular purpose, nor does ON Semiconductor assume any liability arising out of the application or use of any product or circuit, and specifically disclaims any and all liability, including without limitation special, consequential or incidental damages. ON Semiconductor does not convey any license under its patent rights nor the rights of others.

**onsemi**, **Onsemi**, and other names, marks, and brands are registered and/or common law trademarks of Semiconductor Components Industries, LLC dba "**onsemi**" or its affiliates and/or subsidiaries in the United States and/or other countries. **onsemi** owns the rights to a number of patents, trademarks, copyrights, trade secrets, and other intellectual property. A listing of **onsemi**'s product/patent coverage may be accessed at [www.onsemi.com/site/pdf/Patent-Marking.pdf](http://www.onsemi.com/site/pdf/Patent-Marking.pdf). **onsemi** reserves the right to make changes at any time to any products or information herein, without notice. The information herein is provided "as-is" and **onsemi** makes no warranty, representation or guarantee regarding the accuracy of the information, product features, availability, functionality, or suitability of its products for any particular purpose, nor does **onsemi** assume any liability arising out of the application or use of any product or circuit, and specifically disclaims any and all liability, including without limitation special, consequential or incidental damages. Buyer is responsible for its products and applications using **onsemi** products, including compliance with all laws, regulations and safety requirements or standards, regardless of any support or applications information provided by **onsemi**. "Typical" parameters which may be provided in **onsemi** data sheets and/or specifications can and do vary in different applications and actual performance may vary over time. All operating parameters, including "Typicals" must be validated for each customer application by customer's technical experts. **onsemi** does not convey any license under any of its intellectual property rights nor the rights of others. **onsemi** products are not designed, intended, or authorized for use as a critical component in life support systems or any FDA Class 3 medical devices or medical devices with a same or similar classification in a foreign jurisdiction or any devices intended for implantation in the human body. Should Buyer purchase or use **onsemi** products for any such unintended or unauthorized application, Buyer shall indemnify and hold **onsemi** and its officers, employees, subsidiaries, affiliates, and distributors harmless against all claims, costs, damages, and expenses, and reasonable attorney fees arising out of, directly or indirectly, any claim of personal injury or death associated with such unintended or unauthorized use, even if such claim alleges that **onsemi** was negligent regarding the design or manufacture of the part. **onsemi** is an Equal Opportunity/Affirmative Action Employer. This literature is subject to all applicable copyright laws and is not for resale in any manner.

## PUBLICATION ORDERING INFORMATION

### LITERATURE FULFILLMENT:

Email Requests to: [orderlit@onsemi.com](mailto:orderlit@onsemi.com)

**onsemi Website:** [www.onsemi.com](http://www.onsemi.com)

### TECHNICAL SUPPORT

**North American Technical Support:**  
Voice Mail: 1 800-282-9855 Toll Free USA/Canada  
Phone: 011 421 33 790 2910

**Europe, Middle East and Africa Technical Support:**

Phone: 00421 33 790 2910

For additional information, please contact your local Sales Representative

## X-ON Electronics

Largest Supplier of Electrical and Electronic Components

*Click to view similar products for [ESD Suppressors / TVS Diodes](#) category:*

*Click to view products by [ON Semiconductor](#) manufacturer:*

Other Similar products are found below :

[60KS200C](#) [D12V0H1U2WS-7](#) [D18V0L1B2LP-7B](#) [82356050220](#) [D5V0M5U6V-7](#) [NTE4902](#) [P4KE27CA](#) [P6KE11CA](#) [P6KE39CA-TP](#)  
[P6KE8.2A](#) [SA110CA](#) [SA60CA](#) [SA64CA](#) [SMBJ12CATR](#) [SMBJ8.0A](#) [SMLJ30CA-TP](#) [ESD101-B1-02ELS E6327](#) [ESD112-B1-02EL E6327](#)  
[ESD119B1W01005E6327XTSA1](#) [ESD5V0J4-TP](#) [ESD5V0L1B02VH6327XTSA1](#) [ESD7451N2T5G](#) [19180-510](#) [CPDT-5V0USP-HF](#)  
[3.0SMCJ33CA-F](#) [3.0SMCJ36A-F](#) [HSPC16701B02TP](#) [D3V3Q1B2DLP3-7](#) [D55V0M1B2WS-7](#) [DESD5V0U1BL-7B](#) [DRTR5V0U4SL-7](#)  
[SCM1293A-04SO](#) [ESD200-B1-CSP0201 E6327](#) [ESD203-B1-02EL E6327](#) [SM12-7](#) [SMF8.0A-TP](#) [SMLJ45CA-TP](#) [CEN955 W/DATA](#)  
[82350120560](#) [82356240030](#) [VESD12A1A-HD1-GS08](#) [CPDUR5V0R-HF](#) [CPDUR24V-HF](#) [CPDQC5V0U-HF](#) [CPDQC5V0USP-HF](#)  
[CPDQC5V0-HF](#) [D1213A-01LP4-7B](#) [D1213A-02WL-7](#) [ESDLIN1524BJ-HQ](#) [5KP100A](#)