

ON Semiconductor

Is Now

onsemi™

To learn more about onsemi™, please visit our website at
www.onsemi.com

onsemi and **onsemi** and other names, marks, and brands are registered and/or common law trademarks of Semiconductor Components Industries, LLC dba "**onsemi**" or its affiliates and/or subsidiaries in the United States and/or other countries. **onsemi** owns the rights to a number of patents, trademarks, copyrights, trade secrets, and other intellectual property. A listing of **onsemi** product/patent coverage may be accessed at www.onsemi.com/site/pdf/Patent-Marking.pdf. **onsemi** reserves the right to make changes at any time to any products or information herein, without notice. The information herein is provided "as-is" and **onsemi** makes no warranty, representation or guarantee regarding the accuracy of the information, product features, availability, functionality, or suitability of its products for any particular purpose, nor does **onsemi** assume any liability arising out of the application or use of any product or circuit, and specifically disclaims any and all liability, including without limitation special, consequential or incidental damages. Buyer is responsible for its products and applications using **onsemi** products, including compliance with all laws, regulations and safety requirements or standards, regardless of any support or applications information provided by **onsemi**. "Typical" parameters which may be provided in **onsemi** data sheets and/or specifications can and do vary in different applications and actual performance may vary over time. All operating parameters, including "Typicals" must be validated for each customer application by customer's technical experts. **onsemi** does not convey any license under any of its intellectual property rights nor the rights of others. **onsemi** products are not designed, intended, or authorized for use as a critical component in life support systems or any FDA Class 3 medical devices or medical devices with a same or similar classification in a foreign jurisdiction or any devices intended for implantation in the human body. Should Buyer purchase or use **onsemi** products for any such unintended or unauthorized application, Buyer shall indemnify and hold **onsemi** and its officers, employees, subsidiaries, affiliates, and distributors harmless against all claims, costs, damages, and expenses, and reasonable attorney fees arising out of, directly or indirectly, any claim of personal injury or death associated with such unintended or unauthorized use, even if such claim alleges that **onsemi** was negligent regarding the design or manufacture of the part. **onsemi** is an Equal Opportunity/Affirmative Action Employer. This literature is subject to all applicable copyright laws and is not for resale in any manner. Other names and brands may be claimed as the property of others.



Is Now Part of



ON Semiconductor®

To learn more about ON Semiconductor, please visit our website at www.onsemi.com

Please note: As part of the Fairchild Semiconductor integration, some of the Fairchild orderable part numbers will need to change in order to meet ON Semiconductor's system requirements. Since the ON Semiconductor product management systems do not have the ability to manage part nomenclature that utilizes an underscore (_), the underscore (_) in the Fairchild part numbers will be changed to a dash (-). This document may contain device numbers with an underscore (_). Please check the ON Semiconductor website to verify the updated device numbers. The most current and up-to-date ordering information can be found at www.onsemi.com. Please email any questions regarding the system integration to Fairchild_questions@onsemi.com.

ON Semiconductor and the ON Semiconductor logo are trademarks of Semiconductor Components Industries, LLC dba ON Semiconductor or its subsidiaries in the United States and/or other countries. ON Semiconductor owns the rights to a number of patents, trademarks, copyrights, trade secrets, and other intellectual property. A listing of ON Semiconductor's product/patent coverage may be accessed at www.onsemi.com/site/pdf/Patent-Marking.pdf. ON Semiconductor reserves the right to make changes without further notice to any products herein. ON Semiconductor makes no warranty, representation or guarantee regarding the suitability of its products for any particular purpose, nor does ON Semiconductor assume any liability arising out of the application or use of any product or circuit, and specifically disclaims any and all liability, including without limitation special, consequential or incidental damages. Buyer is responsible for its products and applications using ON Semiconductor products, including compliance with all laws, regulations and safety requirements or standards, regardless of any support or applications information provided by ON Semiconductor. "Typical" parameters which may be provided in ON Semiconductor data sheets and/or specifications can and do vary in different applications and actual performance may vary over time. All operating parameters, including "Typicals" must be validated for each customer application by customer's technical experts. ON Semiconductor does not convey any license under its patent rights nor the rights of others. ON Semiconductor products are not designed, intended, or authorized for use as a critical component in life support systems or any FDA Class 3 medical devices or medical devices with a same or similar classification in a foreign jurisdiction or any devices intended for implantation in the human body. Should Buyer purchase or use ON Semiconductor products for any such unintended or unauthorized application, Buyer shall indemnify and hold ON Semiconductor and its officers, employees, subsidiaries, affiliates, and distributors harmless against all claims, costs, damages, and expenses, and reasonable attorney fees arising out of, directly or indirectly, any claim of personal injury or death associated with such unintended or unauthorized use, even if such claim alleges that ON Semiconductor was negligent regarding the design or manufacture of the part. ON Semiconductor is an Equal Opportunity/Affirmative Action Employer. This literature is subject to all applicable copyright laws and is not for resale in any manner.



April 2015

FAN53202

5 A, 2.4 MHz, Digitally Programmable TinyBuck® Regulator

Features

- Up to 91% Efficiency
- Quiescent Current in PFM Mode: 60 μ A (Typical)
- Digitally Programmable Output Voltage:
 - 0.6-1.3875 V in 12.5 mV Steps
- Best-in-Class Load Transient
- Continuous Output Current Capability: 5 A
- 2.5 V to 5.5 V Input Voltage Range
- Programmable Slew Rate for Voltage Transitions
- Fixed-Frequency Operation: 2.4 MHz
- I²C-Compatible Interface Up to 3.4 Mbps
- Internal Soft-Start
- Input Under-Voltage Lockout (UVLO)
- Thermal Shutdown and Overload Protection
- 20-Bump Wafer-Level Chip Scale Package (WLCSP)

Applications

- Application, Graphic, and DSP Processors
 - ARM™, Krait™, OMAP™, NovaThor™, ARMADA™
- Hard Disk Drives
- Tablets, Netbooks, Ultra-Mobile PCs
- Smart Phones
- Gaming Devices

Description

The FAN53202 is a step-down switching voltage regulator that delivers a digitally programmable output from an input voltage supply of 2.5 V to 5.5 V. The output voltage is programmed through an I²C interface capable of operating up to 3.4 MHz.

Using a proprietary architecture with synchronous rectification, the FAN53202 is capable of delivering 5 A continuous at over 80% efficiency, while maintaining over 80% efficiency at load currents as low as 10 mA. The device can also support a 7 A 500 ms pulse. The regulator operates at a nominal fixed frequency of 2.4 MHz, which reduces the value of the external components to 330 nH for the inductor and as low as 22 μ F for the output capacitor. Additional output capacitance can be added to improve regulation during load transients without affecting stability. Inductance up to 1.2 μ H may be used with additional output capacitance.

At moderate and light loads, Pulse Frequency Modulation (PFM) is used to operate in Power-Save Mode with a typical quiescent current of 60 μ A. Even with such a low quiescent current, the part exhibits excellent transient response during large load swings. At higher loads, the system automatically switches to fixed-frequency control, operating at 2.4 MHz. In Shutdown Mode, the supply current drops below 1 μ A, reducing power consumption. PFM Mode can be disabled if constant frequency is desired. The FAN53202 is available in a 20-bump, 1.6 x 2 mm, WLCSP.

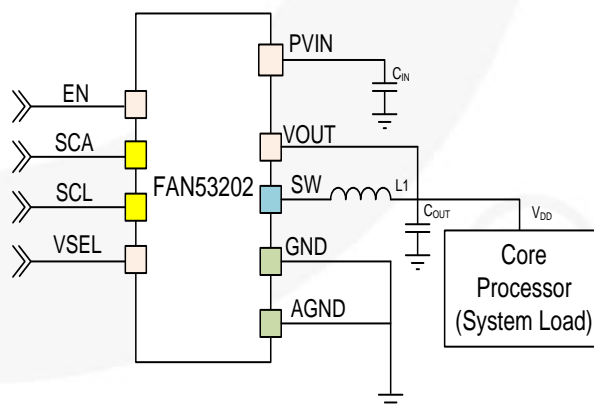

Figure 1. Typical Application

All trademarks are the property of their respective owners.

Ordering Information

| Part Number | Power-Up Defaults | | I2C Slave Address | Max Pulse Current (500ms) | Temperature Range | Package | Packing Method | Device Marking |
|---------------|-------------------|--------|-------------------|---------------------------|-------------------|----------|----------------|----------------|
| | VSEL0 | VSEL1 | | | | | | |
| FAN53202UC23X | 1.15 V | 1.15 V | C0 | 7.0 A | -40 to 85°C | WLCSP-20 | Tape & Reel | CK |

Pin Configuration

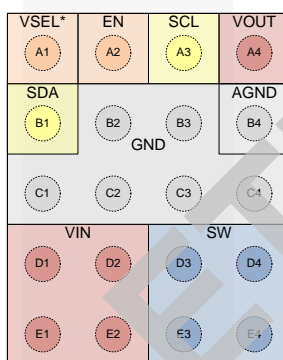

Figure 2. Top View

Pin Definitions

| Pin # | Name | Description |
|-----------------|------|--|
| A1 | VSEL | Voltage Select. When this pin is LOW, V_{OUT} is set by the VSEL0 register. When this pin is HIGH, V_{OUT} is set by the VSEL1 register. |
| A2 | EN | Enable. The device is in Shutdown Mode when this pin is LOW. All register values are kept during shutdown. All registers go to default values when EN pin is LOW. |
| A3 | SCL | I²C Serial Clock |
| A4 | VOUT | VOUT. Sense pin for V_{OUT} . Connect to C_{OUT} . |
| B1 | SDA | I²C Serial Data |
| B2, B3, C1 – C4 | GND | Ground. Low-side MOSFET is referenced to this pin. C_{IN} and C_{OUT} should be returned with a minimal path to these pins. |
| B4 | AGND | Analog Ground. All signals are referenced to this pin. Avoid routing high dV/dt AC currents through this pin. |
| D1, D2, E1, E2 | VIN | Power Input Voltage. Connect to the input power source. Connect to C_{IN} with minimal path. |
| D3, D4, E3, E4 | SW | Switching Node. Connect to the inductor. |

Absolute Maximum Ratings

Stresses exceeding the absolute maximum ratings may damage the device. The device may not function or be operable above the recommended operating conditions and stressing the parts to these levels is not recommended. In addition, extended exposure to stresses above the recommended operating conditions may affect device reliability. The absolute maximum ratings are stress ratings only.

| Symbol | Parameter | | Min. | Max. | Unit |
|------------------------|---|---|------|--------------------------------|------|
| V _{IN} | Voltage on SW, VIN Pins | IC Not Switching | -0.3 | 7.0 | V |
| | | IC Switching | -0.3 | 6.5 | |
| | Voltage on All Other Pins | IC Not Switching | -0.3 | V _{IN} ⁽¹⁾ | V |
| V _{OUT} | Voltage on VOUT Pin | | -0.3 | 3.0 | V |
| V _{INOV_SLEW} | Maximum Slew Rate of V _{IN} > 6.5 V, PWM Switching | | | 100 | V/ms |
| ESD | Electrostatic Discharge Protection Level | Human Body Model, ANSI/ESDA/JEDEC JS-001-2012 | 2500 | | V |
| | | Charged Device Model per JESD22-C101 | 1500 | | |
| T _J | Junction Temperature | | -40 | +150 | °C |
| T _{STG} | Storage Temperature | | -65 | +150 | °C |
| T _L | Lead Soldering Temperature, 10 Seconds | | | +260 | °C |

Note:

1. Lesser of 7 V or V_{IN}+0.3 V.

Recommended Operating Conditions

The Recommended Operating Conditions table defines the conditions for actual device operation. Recommended operating conditions are specified to ensure optimal performance to the datasheet specifications. Fairchild does not recommend exceeding them or designing to Absolute Maximum Ratings.

| Symbol | Parameter | Min. | Typ. | Max. | Unit |
|------------------|--------------------------------|------|------|------|------|
| V _{IN} | Supply Voltage Range | 2.5 | | 5.5 | V |
| I _{OUT} | Output Current | 0 | | 5 | A |
| L | Inductor | | 0.33 | | μH |
| C _{IN} | Input Capacitor | | 10 | | μF |
| C _{OUT} | Output Capacitor | | 44 | | μF |
| T _A | Operating Ambient Temperature | -40 | | +85 | °C |
| T _J | Operating Junction Temperature | -40 | | +125 | °C |

Thermal Properties

| Symbol | Parameter | Min. | Typ. | Max. | Unit |
|-----------------|---|------|------|------|------|
| θ _{JA} | Junction-to-Ambient Thermal Resistance ⁽²⁾ | | 38 | | °C/W |

Note:

2. See Thermal Considerations in the Application Information section.

Electrical Characteristics

Minimum and maximum values are at $V_{IN} = 2.5\text{ V}$ to 5.5 V , $T_A = -40^\circ\text{C}$ to $+85^\circ\text{C}$, unless otherwise noted. Typical values are at $T_A = 25^\circ\text{C}$, $V_{IN} = 5\text{ V}$ and $EN = \text{HIGH}$.

| Symbol | Parameter | Condition | Min. | Typ. | Max. | Unit |
|--|--|---|------|------|------|---------------|
| Power Supplies | | | | | | |
| I_Q | Quiescent Current | $I_{LOAD}=0$ | | 60 | 100 | μA |
| I_{SD} | H/W Shutdown Supply Current | $EN = \text{GND}$ | | 0.1 | 5.0 | μA |
| | S/W Shutdown Supply Current | $EN = V_{IN}, \text{BUCK_EN}_x = 0$ | | 41 | 75 | μA |
| V_{UVLO} | Under-Voltage Lockout Threshold | V_{IN} Rising | | 2.35 | 2.45 | V |
| V_{UVHYST} | Under-Voltage Lockout Hysteresis | | | 350 | | mV |
| EN, VSEL, SDA, SCL | | | | | | |
| V_{IH} | HIGH-Level Input Voltage | | 1.1 | | | V |
| V_{IL} | LOW-Level Input Voltage | | | | 0.4 | V |
| V_{LHYST} | Logic Input Hysteresis Voltage | | | 160 | | mV |
| I_{IN} | Input Bias Current for Logic Pin | Input Tied to GND or 1.8V | | 0.01 | 1.00 | μA |
| PGOOD | | | | | | |
| I_{OUTL} | PGOOD Pull-Down Current | | | | 1 | mA |
| I_{OUTH} | PGOOD HIGH Leakage Current | | | 0.01 | 1.00 | μA |
| V_{OUT} Regulation | | | | | | |
| V_{REG} | V_{OUT} DC Accuracy | $I_{OUT(DC)} = 0$ to 5A, Auto Mode, $2.5\text{ V} \leq V_{IN} \leq 4.5\text{ V}$ | 2.0 | | 4.0 | % |
| Power Switch and Protection | | | | | | |
| I_{LIMPK} | P-MOS Peak Current Limit | Open Loop | 8.5 | 10.0 | 11.5 | A |
| V_{SDWN} | Input OVP Shutdown | Rising Threshold | | 6.15 | | V |
| | | Falling Threshold | 5.50 | 5.85 | | V |
| Frequency Control | | | | | | |
| f_{SW} | Oscillator Frequency (FPWM) | | 2.05 | 2.40 | 2.75 | MHz |
| R_{OFF} | V_{OUT} Pull-Down Resistance, Disabled | $EN = 0$ or $V_{IN} < V_{UVLO}$ | | 160 | | Ω |

Note:

- Monotonicity assured by design.

System Characteristics

The following table is verified by design and verified while using the following external components: L = 0.33 μ H, DFE252012F (TOKO), C_{IN} = C2012X5R1A106M (TDK), C_{OUT} = 2 x C2012X5R0J226M (TDK) These parameters are not verified in production. Minimum and maximum values are at V_{IN} = 2.5 V to 5.5 V, V_{EN} = 1.8 V, T_A = -40°C to +85°C; circuit of Figure 1, unless otherwise noted. Typical values are at T_A = 25°C, V_{IN} = 3.6V, V_{EN} = 1.8 V.

| Symbol | Parameter | | Min. | Typ. | Max. | Unit |
|-------------------------|------------------|--|------|----------|------|---------|
| ΔV_{OUT1} | Load Regulation | I _{OUT} = 0 A to 2.5 A, V _{IN} = 3.8 V (Auto) | | 0.3 | | %A |
| | | I _{OUT} = 1 A to 5 A, V _{IN} = 3.8 V (PWM) | | 0.1 | | |
| ΔV_{OUT2} | Line Regulation | 3.6 V \leq V _{IN} \leq 4.0 V, I _{OUT} = 3 A | | 0.03 | | %/V |
| V _{OUT_RIPPLE} | Ripple Voltage | V _{IN} = 3.8 V, I _{OUT} = 100 mA, PFM Mode | | 15 | | mV |
| | | V _{IN} = 3.8 V, I _{OUT} = 2000 mA, PWM Mode | | 5 | | |
| η | Efficiency | P _{VIN} = 3.6 V, V _{OUT} = 1.15 V, I _{OUT} = 100 mA | | 87 | | % |
| | | P _{VIN} = 3.6 V, V _{OUT} = 1.15 V, I _{OUT} = 500 mA | | 89 | | |
| | | P _{VIN} = 3.6 V, V _{OUT} = 1.15 V, I _{OUT} = 2 A | | 89 | | |
| T _{SS} | Soft-Start | EN High to 95% of Target_ V _{OUT} . (1.15 V), R _{LOAD} = 50 Ω | | 340 | | μ s |
| ΔV_{OUT_LOAD} | Load Transient | I _{OUT} = 0.1 A \leftrightarrow 1.2 A, T _R = T _F = 100 ns | | \pm 40 | | mV |
| ΔV_{OUT_LINE} | Line Transient | V _{IN} = 3.0 V \leftrightarrow 3.6 V, T _R = T _F = 10 μ s, I _{OUT} = 500 mA | | \pm 25 | | mV |
| T _{LIMIT} | Thermal Shutdown | | | 150 | | °C |

Typical Characteristics

Unless otherwise specified, $V_{IN} = 3.6\text{ V}$, $V_{OUT} = 1.15\text{ V}$, $V_{EN} = 1.8\text{ V}$, $T_A = 25^\circ\text{C}$; circuit and components according to Figure 1.

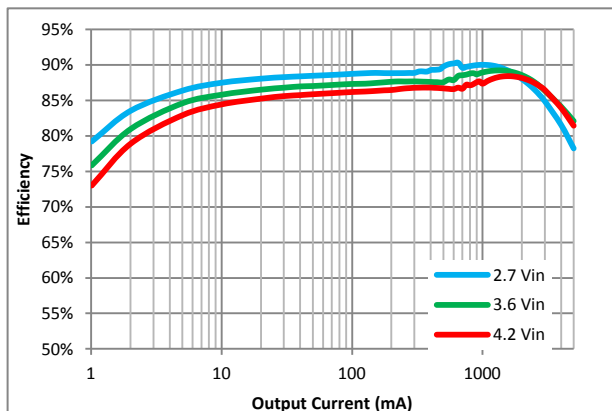

Figure 3. Efficiency vs. Load Current and Input Voltage

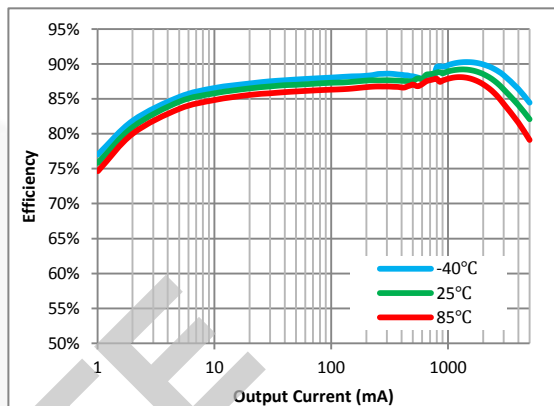

Figure 4. Efficiency vs. Load Current and Temperature

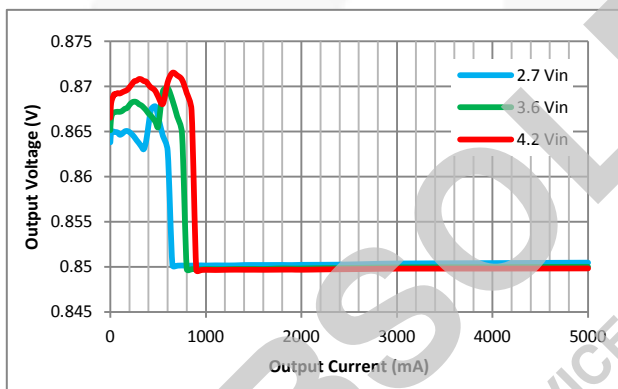

Figure 5. Output Regulation vs. Load Current and Input Voltage, $V_{OUT}=0.85\text{ V}$

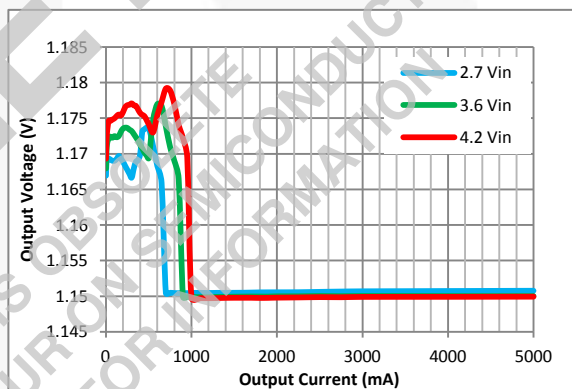

Figure 6. Output Regulation vs. Load Current and Input Voltage, $V_{OUT}=1.15\text{ V}$

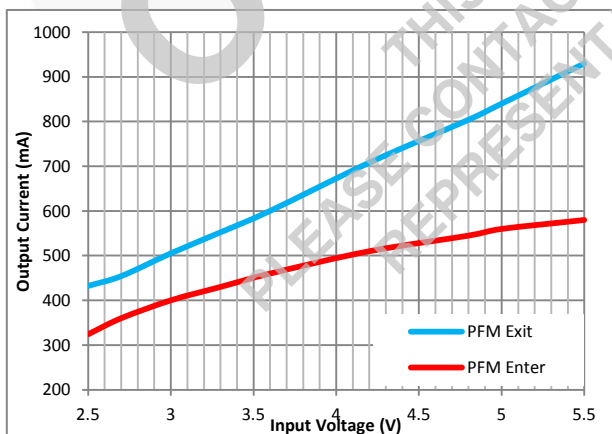

Figure 7. PFM Entry / Exit Level vs. Input Voltage, $V_{OUT}=0.85\text{ V}$

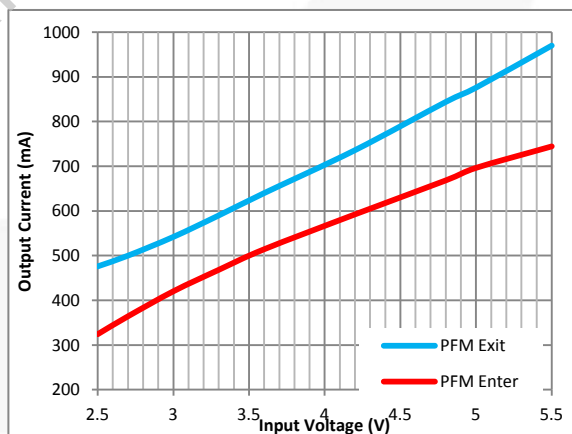

Figure 8. PFM Entry / Exit Level vs. Input Voltage, $V_{OUT}=1.15\text{ V}$

Typical Characteristics (Continued)

Unless otherwise specified, $V_{IN} = 3.6\text{ V}$, $V_{OUT} = 1.15\text{ V}$, $V_{EN} = 1.8\text{ V}$, $T_A = 25^\circ\text{C}$; circuit and components according to Figure 1.

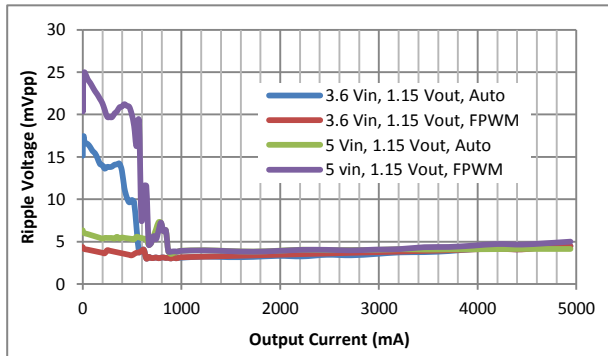

Figure 9. Output Ripple vs. Load Current

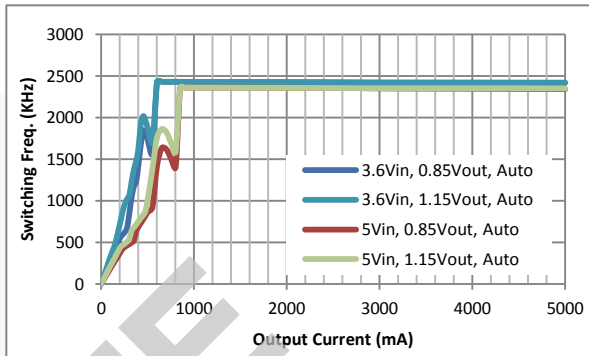

Figure 10. Frequency vs. Load Current

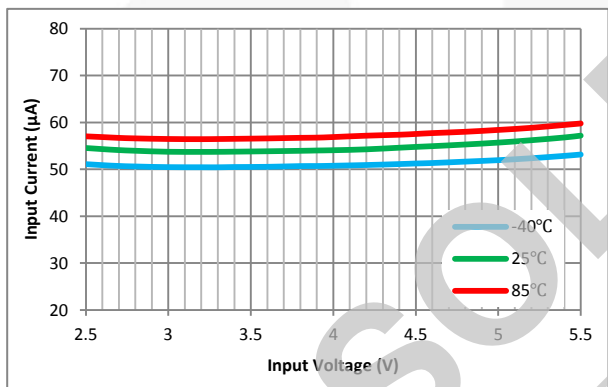

Figure 11. Quiescent Current vs. Input Voltage and Temperature, Auto PWM

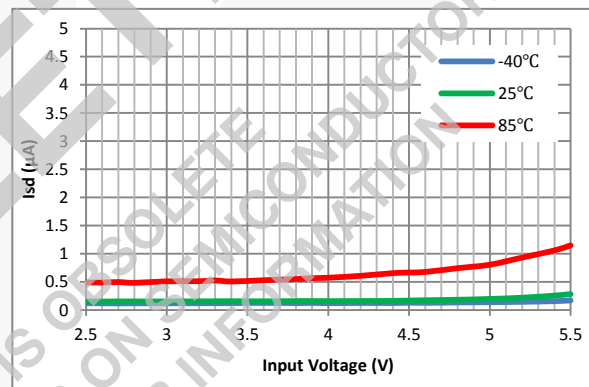

Figure 12. Shutdown Current vs. Input Voltage and Temperature

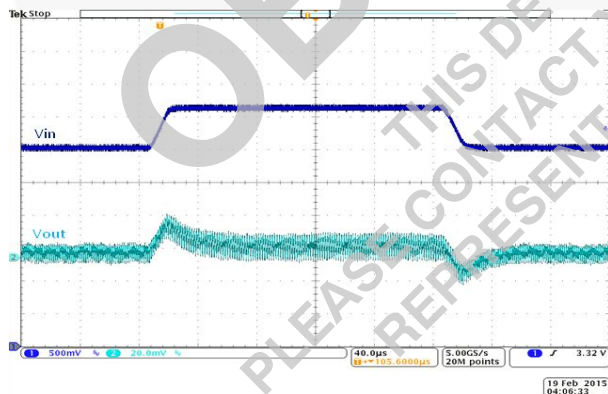

Figure 13. Line Transient, $V_{IN} = 3.0\text{ V} \Leftrightarrow 3.6\text{ V}$, $T_R=T_F=10\text{ }\mu\text{s}$ Auto Mode $I_{OUT} = 250\text{ mA}$

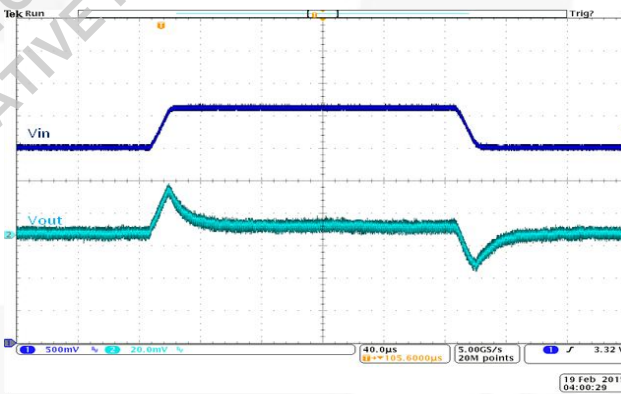

Figure 14. Line Transient, $V_{IN} = 3.0\text{ V} \Leftrightarrow 3.6\text{ V}$, $T_R=T_F=10\text{ }\mu\text{s}$ Auto Mode $I_{OUT} = 2\text{ A}$

Typical Characteristics (Continued)

Unless otherwise specified, $V_{IN} = 3.6\text{ V}$, $V_{OUT} = 1.15\text{ V}$, $V_{EN} = 1.8\text{ V}$, $T_A = 25^\circ\text{C}$; circuit and components according to Figure 1.

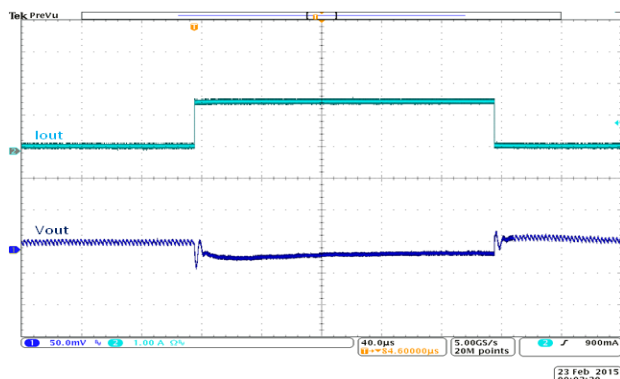

Figure 15. Load Transient, $I_{OUT} = 0.1\text{ A} \leftrightarrow 1.6\text{ A}$, Auto Mode $T_R = T_F = 100\text{ ns}$

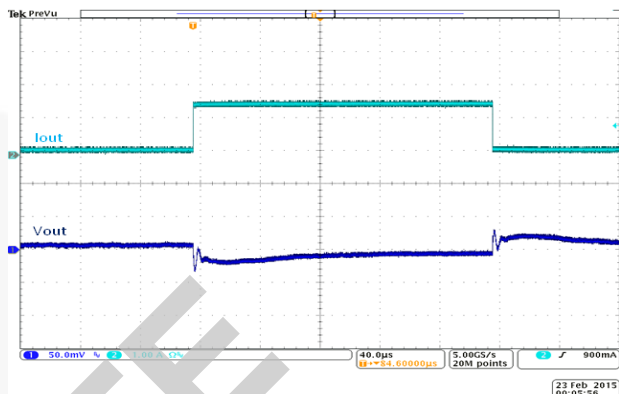

Figure 16. Load Transient, $I_{OUT} = 0.1\text{ A} \leftrightarrow 1.6\text{ A}$, FPWM Mode $T_R = T_F = 100\text{ ns}$

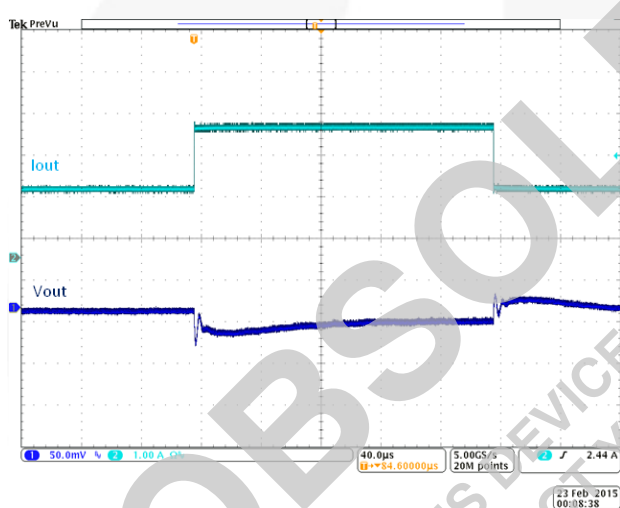

Figure 17. Load Transient, $I_{OUT} = 1.5\text{ A} \leftrightarrow 3\text{ A}$, Auto Mode $T_R = T_F = 100\text{ ns}$

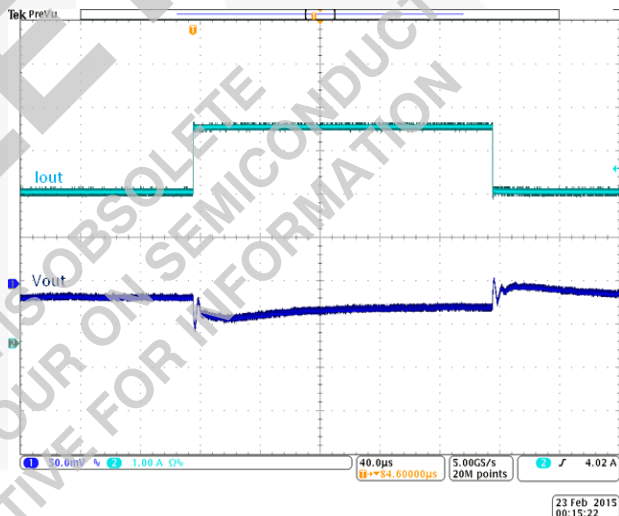

Figure 18. Load Transient, $I_{OUT} = 3.5\text{ A} \leftrightarrow 5\text{ A}$, Auto Mode $T_R = T_F = 100\text{ ns}$

OBSOLETE

PLEASE CONTACT YOUR SEMICONDUCTOR REPRESENTATIVE FOR INFORMATION

Operation Description

The FAN53202 is a step-down switching voltage regulator that delivers a programmable output voltage from an input voltage supply of 2.5 V to 5.5 V. Using a proprietary architecture with synchronous rectification, the FAN53202 is capable of delivering 5 A at over 80% efficiency. The regulator operates at a nominal frequency of 2.4 MHz at full load, which reduces the value of the external components to 330 nH for the output inductor and 22 μ F for the output capacitor. High efficiency is maintained at light load with single-pulse PFM.

The FAN53202 integrates an I²C-compatible interface, allowing transfers up to 3.4 Mbps. This communication interface can be used to:

- Dynamically re-program the output voltage in 12.5 mV
- Reprogram the mode to enable or disable PFM;
- Control voltage transition slew rate; or
- Enable / disable the regulator.

Control Scheme

The FAN53202 uses a proprietary non-linear, fixed-frequency PWM modulator to deliver a fast load transient response, while maintaining a constant switching frequency over a wide range of operating conditions. The regulator performance is independent of the output capacitor ESR, allowing for the use of ceramic output capacitors. Although this type of operation normally results in a switching frequency that varies with input voltage and load current, an internal frequency loop holds the switching frequency constant over a large range of input voltages and load currents.

For very light loads, the FAN53202 operates in Discontinuous Current Diode (DCM) single-pulse PFM, which produces low output ripple compared with other PFM architectures. Transition between PWM and PFM is relatively seamless, providing a smooth transition between DCM and CCM Modes.

PFM can be disabled by programming the MODE bit HIGH in the VSEL registers.

Enable and Soft-Start

When the EN pin is LOW; the IC is shutdown, all internal circuits are off, and the part draws very little current. In this state, I²C cannot be written to or read from. All registers are reset to default values when EN pin is LOW.

When the OUTPUT_DISCHARGE bit in the CONTROL register is enabled (logic HIGH) and the EN pin is LOW or the BUCK_ENx bit is LOW, a load is connected from VOUT to GND to discharge the output capacitors.

Raising EN while the BUCK_ENx bit is HIGH activates the part and begins the soft-start cycle. During soft-start, the modulator's internal reference is ramped slowly to minimize surge currents on the input and prevent overshoot of the output voltage. Synchronous rectification is inhibited during soft-start, allowing the IC to start into a pre-charged capacitive load.

If large output capacitance values are used, the regulator may fail to start. Maximum C_{OUT} capacitance for successfully starting with a heavy constant-current load is approximately:

$$C_{OUTMAX} \approx (I_{LIMPK} - I_{LOAD}) \cdot \frac{320\mu}{V_{OUT}} \quad (1)$$

where C_{OUTMAX} is expressed in μ F and I_{LOAD} is the load current during soft-start, expressed in A.

If the regulator is at its current limit for 16 consecutive current limit cycles, the regulator shuts down and enters 3-state before reattempting soft-start 1700 ms later. This limits the duty cycle of full output current during soft-start to prevent excessive heating.

The IC allows for software enable of the regulator, when EN is HIGH, through the BUCK_EN bits. BUCK_EN0 and BUCK_EN1 are both initialized HIGH.

Table 1. Hardware and Software Enable

| Pins | | BITS | | |
|------|------|----------|----------|--------|
| EN | VSEL | BUCK_EN0 | BUCK_EN1 | Output |
| 0 | X | X | X | OFF |
| 1 | 0 | 0 | X | OFF |
| 1 | 0 | 1 | X | ON |
| 1 | 1 | X | 0 | OFF |
| 1 | 1 | X | 1 | ON |

VSEL Pin and I²C Programming Output Voltage

The output voltage is set by the NSELx control bits in VSEL0 and VSEL1 registers. The output voltage is given as:

$$V_{OUT} = 0.60V + NSELx \cdot 12.5mV \quad (2)$$

Output voltage can also be controlled by toggling the VSEL pin LOW or HIGH. VSEL LOW corresponds to VSEL0 and VSEL HIGH corresponds to VSEL1. Upon POR, VSEL0 and VSEL1 are reset to their default voltages, shown in Table 5.

Transition Slew Rate Limiting

When transitioning from a low- to high-voltage, the IC can be programmed for one of eight possible slew rates using the SLEW bits in the CONTROL register (Table 5 and Table 6).

Table 2. Transition Slew Rate

| Decimal | Bin | Slew Rate | |
|---------|-----|-----------|--------------|
| 0 | 000 | 80 | mV / μ s |
| 1 | 001 | 40 | mV / μ s |
| 2 | 010 | 20 | mV / μ s |
| 3 | 011 | 10 | mV / μ s |
| 4 | 100 | 5 | mV / μ s |
| 5 | 101 | 2.5 | mV / μ s |
| 6 | 110 | 1.25 | mV / μ s |
| 7 | 111 | 0.625 | mV / μ s |

Transitions from high to low voltage rely on the output load to discharge VOUT to the new set point. Once the high-to-low transition begins, the IC stops switching until VOUT has reached the new set point.

Under-Voltage Lockout

When EN is HIGH, the under-voltage lockout keeps the part from operating until the input supply voltage rises HIGH enough to properly operate. This ensures proper operation of the regulator during startup or shutdown.

Input Over-Voltage Protection (OVP)

When V_{IN} exceeds V_{SDWN} (about 6.2 V) the IC stops switching to protect the circuitry from internal spikes above 6.5 V. An internal filter prevents the circuit from shutting down due to noise spikes.

Current Limiting

A heavy load or short circuit on the output causes the current in the inductor to increase until a maximum current threshold is reached in the high-side switch. Upon reaching this point, the high-side switch turns off, preventing high currents from causing damage. Sixteen consecutive current limit cycles in current limit cause the regulator to shut down and stay off for about 1700 μ s before attempting a restart.

Thermal Shutdown

When the die temperature increases, due to a high load condition and/or high ambient temperature, the output switching is disabled until the die temperature falls sufficiently. The junction temperature at which the thermal shutdown activates is nominally 150°C with a 17°C hysteresis. ²C Interface

I²C Interface

The FAN53202's serial interface is compatible with Standard, Fast, Fast Plus, and HS Mode I²C-Bus® specifications. The FAN53202's SCL line is an input and its SDA line is a bi-directional open-drain output; it can only pull down the bus when active. The SDA line only pulls LOW during data reads and when signaling ACK. All data is shifted in MSB (bit 7) first.

I²C Slave Address

In hex notation, the slave address assumes a 0 LS Bit. The hex slave address is C0.

Table 3. I²C Slave Address

| Hex | Bits | | | | | | | R/W |
|-----|------|---|---|---|---|---|---|-----|
| | 7 | 6 | 5 | 4 | 3 | 2 | 1 | |
| C0 | 1 | 1 | 0 | 0 | 0 | 0 | 0 | R/W |

Other slave addresses can be assigned. Contact a Fairchild Semiconductor representative.

Bus Timing

As shown in Figure 19, data is normally transferred when SCL is LOW. Data is clocked in on the rising edge of SCL. Typically, data transitions shortly at or after the falling edge of SCL to allow ample time for the data to set up before the next SCL rising edge.

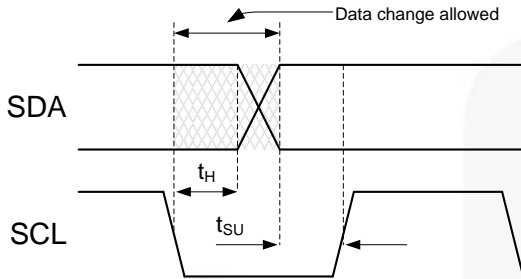

Figure 19. Data Transfer Timing

Each bus transaction begins and ends with SDA and SCL HIGH. A transaction begins with a START condition, which is defined as SDA transitioning from 1 to 0 with SCL HIGH, as shown in Figure 20

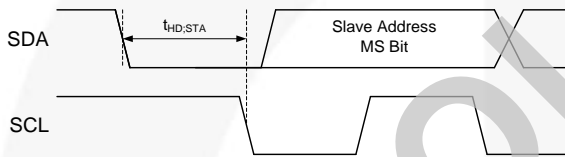

Figure 20. START Bit

A transaction ends with a STOP condition, which is defined as SDA transitioning from 0 to 1 with SCL HIGH, as shown in Figure 21.

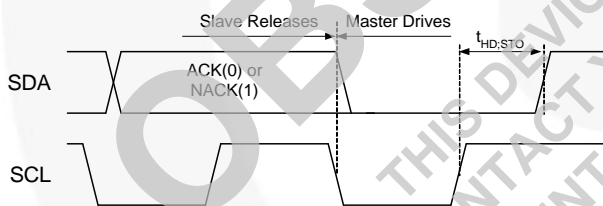

Figure 21. STOP Bit

During a read from the FAN53202, the master issues a REPEATED START after sending the register address, and before resending the slave address. The REPEATED START is a 1 to 0 transition on SDA while SCL is HIGH, as shown in Figure 22.

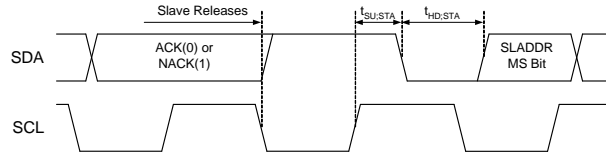

Figure 22. REPEATED START Timing

High-Speed (HS) Mode

The protocols for High-Speed (HS), Low-Speed (LS), and Fast-Speed (FS) Modes are identical, except the bus speed for HS mode is 3.4 MHz. HS Mode is entered when the bus master sends the HS master code 00001XXX after a START condition. The master code is sent in Fast or Fast-Plus Mode (less than 1 MHz clock); slaves do not ACK this transmission.

The master generates a REPEATED START condition (Figure 20) that causes all slaves on the bus to switch to HS Mode. The master then sends I²C packets, as described above, using the HS Mode clock rate and timing.

The bus remains in HS Mode until a STOP bit (Figure 21) is sent by the master. While in HS Mode, packets are separated by REPEATED START conditions (Figure 22) Read and Write Transactions.

The following figures outline the sequences for data read and write. Bus control is signified by the shading of the packet, defined as Master Drives Bus and Slave Drives Bus. All addresses and data are MSB first.

Table 4. I²C Bit Definitions for Figure 23 & Figure 24

| Symbol | Definition |
|-----------|---|
| R | REPEATED START, <i>see Figure 22</i> |
| P | STOP, <i>see Figure 21</i> |
| S | START, <i>see Figure 20</i> |
| A | ACK. The slave drives SDA to 0 to acknowledge the preceding packet. |
| \bar{A} | NACK. The slave sends a 1 to NACK the preceding packet. |
| R | REPEATED START, <i>see Figure 22</i> |
| P | STOP, <i>see Figure 21</i> |

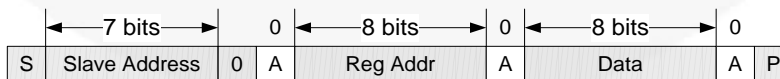

Figure 23. Write Transaction



Figure 24. Read Transaction

Register Description

Table 5. Map

| Hex Address | Name | Function |
|-------------|---------|---|
| 00 | VSEL0 | Controls V_{OUT} settings when VSEL pin = 0 |
| 01 | VSEL1 | Controls V_{OUT} settings when VSEL pin = 1 |
| 02 | CONTROL | Determines whether V_{OUT} output discharge is enabled and also the slew rate of positive transitions |
| 03 | ID1 | Read-only register identifies vendor and chip type |
| 04 | ID2 | Read-only register identifies die revision |
| 05 | MONITOR | Indicates device status |

Table 6. Bit Definitions

The following table defines the operation of each register bit. Bold indicates power-on default values.

| Bit | Name | Value | Description |
|---|------------------|-----------------|---|
| VSEL0 R/W Register Address: 00 | | | |
| 7 | BUCK_EN0 | 1 | Software buck enable. When EN pin is LOW, the regulator is off. When EN pin is HIGH, BUCK_EN bit takes precedent. |
| 6 | MODE0 | 0 | Allow Auto-PFM Mode during light load. |
| | | 1 | Forced PWM Mode. |
| 5:0 | NSEL0 | | Sets V_{OUT} value from 0.6V to 1.3875 V in 12.5 mV steps |
| VSEL1 R/W Register Address: 01 | | | |
| 7 | BUCK_EN1 | 1 | Software buck enable. When EN pin is LOW, the regulator is off. When EN pin is HIGH, BUCK_EN bit takes precedent. |
| 6 | MODE1 | 0 | Allow AUTO-PFM Mode during light load. |
| | | 1 | Forced PWM Mode. |
| 5:0 | NSEL1 | | Sets V_{OUT} value from 0.6V to 1.3875 V in 12.5 mV steps |
| CONTROL R/W Register Address: 02 | | | |
| 7 | OUTPUT_DISCHARGE | 0 | When the regulator is disabled, V_{OUT} is not discharged. |
| | | 1 | When the regulator is disabled, V_{OUT} discharges through an internal pull-down. |
| 6:4 | SLEW | 000 | Sets the slew rate for positive voltage transitions (<i>see Table 2</i>). |
| 3 | Reserved | 0 | Always reads back 0 |
| 2 | Reserved | 0 | Always reads back 0 |
| 1:0 | Reserved | 00 | Always reads back 00 |
| ID1 R Register Address: 03 | | | |
| 7:5 | VENDOR | 100 | Signifies Fairchild as the IC vendor |
| 4 | Reserved | 0 | Always reads back 0 |
| 3:0 | DIE_ID | 0000 | Refer to ordering information |
| ID2 R Register Address: 04 | | | |
| 7:4 | Reserved | 0000 | Always reads back 0000 |
| 3:0 | DIE_REV | 1100 | IC mask revision |
| MONITOR R Register Address: 05 | | | |
| 7 | PGOOD | 0 | 1: buck is enabled and soft-start is completed |
| 6:0 | Not used | 000 0000 | Always reads back 000 0000 |

Application Information

Selecting the Inductor

The output inductor must meet both the required inductance and the energy-handling capability of the application. The inductor value affects the average current limit, the output voltage ripple, and the efficiency.

The ripple current (ΔI) of the regulator is:

$$\Delta I \approx \frac{V_{OUT}}{V_{IN}} \cdot \left(\frac{V_{IN} - V_{OUT}}{L \cdot f_{SW}} \right) \quad (3)$$

The maximum average load current, $I_{MAX(Load)}$, is related to the peak current limit, $I_{LIM(PK)}$, by the ripple current such that:

$$I_{MAX(Load)} = I_{LIM(PK)} - \frac{\Delta I}{2} \quad (4)$$

The FAN53202 is optimized for operation with $L=330$ nH, but is stable with inductances up to 1.0 μ H (nominal). The inductor should be rated to maintain at least 80% of its value at $I_{LIM(PK)}$. Failure to do so will lower the amount of DC current the IC can deliver.

Efficiency is affected by the inductor DCR and inductance value. Decreasing the inductor value for a given physical size typically decreases the DCR; but since ΔI increases, the RMS current increases, as do core and skin-effect losses.

$$I_{RMS} = \sqrt{I_{OUT(DC)}^2 + \frac{\Delta I^2}{12}} \quad (5)$$

The increased RMS current produces higher losses through the $R_{DS(ON)}$ of the IC MOSFETs as well as the inductor ESR.

Increasing the inductor value produces lower RMS currents, but degrades transient response. For a given physical inductor size, increased inductance usually results in an inductor with lower saturation current.

Table 7. Effects of Inductor Value (from 330 nH Recommended) on Regulator Performance

| $I_{MAX(Load)}$ | ΔV_{OUT} (Eq.(7)) | Transient Response |
|-----------------|---------------------------|--------------------|
| Increase | Decrease | Degraded |

Inductor Current Rating

The current limit circuit can allow substantial peak currents to flow through L1 under worst-case conditions. If it is possible for the load to draw such currents, the inductor should be capable of sustaining the current or failing in a safe manner.

For space-constrained applications, a lower current rating for L1 can be used. The FAN53202 may still protect these inductors in the event of a short circuit, but may not be able to protect the inductor from failure if the load is able to draw higher currents than the DC rating of the inductor.

Output Capacitor and V_{OUT} Ripple

The reference BOM suggests 0805 capacitors, but 0603 capacitors may be used if space is at a premium. Due to

voltage effects, the 0603 capacitors have a lower in-circuit capacitance than the 0805 package, which can degrade transient response and output ripple.

Increasing C_{OUT} has negligible effect on loop stability and can be increased to reduce output voltage ripple or to improve transient response. Output voltage ripple, ΔV_{OUT} , is calculated by:

$$\Delta V_{OUT} = \Delta I_L \left[\frac{f_{SW} \cdot C_{OUT} \cdot ESR^2}{2 \cdot D \cdot (1-D)} + \frac{1}{8 \cdot f_{SW} \cdot C_{OUT}} \right] \quad (6)$$

where C_{OUT} is the effective output capacitance.

The capacitance of C_{OUT} decreases at higher output voltages, which results in higher ΔV_{OUT} . Equation (6) is only valid for Continuous Current Mode (CCM) operation, which occurs when the regulator is in PWM Mode.

For large C_{OUT} values, the regulator may fail to start under a load. If an inductor value greater than 1.0 μ H is used, at least 30 μ F of C_{OUT} should be used to ensure stability.

The lowest ΔV_{OUT} is obtained when the IC is in PWM Mode and, therefore, operating at 2.4 MHz. In PFM Mode, f_{SW} is reduced, causing ΔV_{OUT} to increase.

ESL Effects

The Equivalent Series Inductance (ESL) of the output capacitor network should be kept low to minimize the square-wave component of output ripple that results from the division ratio C_{OUT} ESL and the output inductor (L_{OUT}). The square-wave component due to the ESL can be estimated as:

$$\Delta V_{OUT(SQ)} \approx V_{IN} \cdot \frac{ESL_{COUT}}{L1} \quad (7)$$

A good practice to minimize this ripple is to use multiple output capacitors to achieve the desired C_{OUT} value. For example, to obtain $C_{OUT}=20$ μ F, a single 22 μ F 0805 would produce twice the square wave ripple as two x 10 μ F 0805.

To minimize ESL, try to use capacitors with the lowest ratio of length to width. 0805s have lower ESL than 1206s. If low output ripple is a chief concern, some vendors produce 0508 or 0612 capacitors with ultra-low ESL. Placing additional small-value capacitors near the load also reduces the high-frequency ripple components.

Input Capacitor

The ceramic input capacitors should be placed as close as possible between the VIN pin and PGND to minimize the parasitic inductance. If a long wire is used to bring power to the IC, additional "bulk" capacitance (electrolytic or tantalum) should be placed between C_{IN} and the power source lead to reduce under-damped ringing that can occur between the inductance of the power source leads and C_{IN} .

The effective C_{IN} capacitance value decreases, as V_{IN} increases due to DC bias effects. This has no significant impact on regulator performance.

Thermal Considerations

Heat is removed from the IC through the solder bumps to the PCB copper. The junction-to-ambient thermal resistance (θ_{JA}) is largely a function of the PCB layout (size, copper weight, and trace width) and the temperature rise from junction to ambient (ΔT).

For the FAN53202UC, θ_{JA} is 38°C/W when mounted on its four-layer evaluation board in still air with two-ounce outer layer copper weight and one-ounce inner layers. Halving the copper thickness results in an increased θ_{JA} of 48°C/W.

For long-term reliable operation, the IC's junction temperature (T_J) should be maintained below 125°C.

To calculate maximum operating temperature ($\leq 125^\circ\text{C}$) for a specific application:

1. Use efficiency graphs to determine efficiency for the desired V_{IN} , V_{OUT} , and load conditions.
2. Calculate total power dissipation using:

$$P_T = V_{OUT} \times I_{LOAD} \times \left(\frac{1}{\eta} - 1 \right) \quad (8)$$

where η is efficiency from Figure 3 and Figure 4.

Estimate inductor copper losses using:

$$P_L = I_{LOAD}^2 \times DCR_L \quad (9)$$

3. Determine IC losses by removing inductor losses (step 3) from total dissipation:

$$P_{IC} = P_T - P_L \quad (10)$$

4. Determine device operating temperature:

$$\Delta T = P_{IC} \times \theta_{JA} \quad \text{and} \quad (11)$$

$$T_{IC} = T_A + \Delta T$$

It is important to note that the $R_{DS(ON)}$ of the IC's power MOSFETs increases linearly with temperature at about 1.21%/°C. This causes the efficiency (η) to degrade with increasing die temperature.

Recommended External Components

Table 8. Recommended Capacitors

| Component | Quantity | Vendor | Vendor | C (μF) | Size | Rated |
|------------------|----------|----------------|--------|--------|------|-------|
| C _{OUT} | 2 Pieces | C2012X5R0J226M | TDK | 22 | 0805 | 6.3 V |
| C _{IN} | 1 Piece | C2012X5R1A106M | TDK | 10 | 0805 | 6.3 V |

Table 9. Recommended Inductors

| Manufacturer | Part# | L (nH) | DCR (mΩ) | I _{SAT} ⁽⁴⁾ | L | W | H |
|---------------------|---------------------|--------|----------|---------------------------------|-----|-----|-----|
| TOKO ⁽⁴⁾ | DFE201610E-R47M | 470 | 16 | 6.3 | 2.0 | 1.6 | 1.0 |
| TOKO | DFE252012F_R33M | 330 | 14 | 8.5 | 2.5 | 2.0 | 1.2 |
| TOKO | FDSD0412-H-R33M | 330 | 16 | 10 | 4.0 | 4.0 | 1.2 |
| Mag. Layers | MMD-04ABNR33M-M1-RU | 330 | 12.5 | 7.5 | 4.5 | 4.1 | 1.2 |
| CYNTEC | PIMB041B-R33MS | 330 | 17 | 8.4 | 4.4 | 4.2 | 1.0 |
| TDK | VLC5020T-R47M | 470 | 15 | 5.4 | 5.0 | 5.0 | 2.0 |

Note:

4. This inductor is recommended for applications with $I_{OUT} < 3 \text{ A}$.

Layout Recommendation

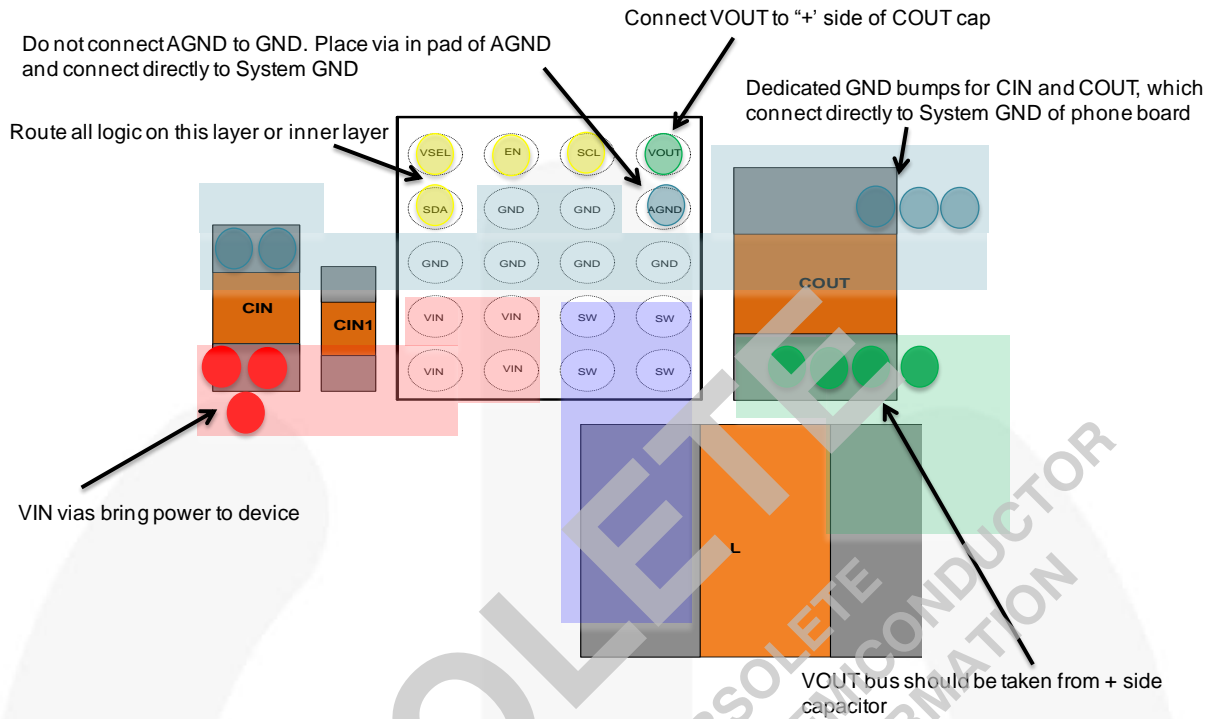

Figure 25. Guidance for Layer 1

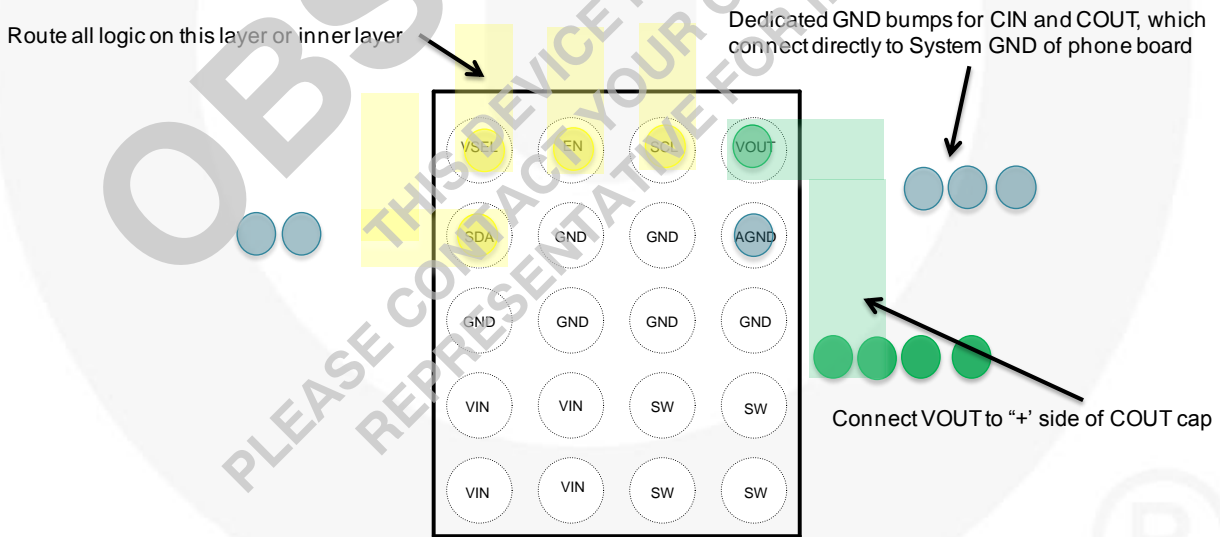

Figure 26. Guidance for Layer 2

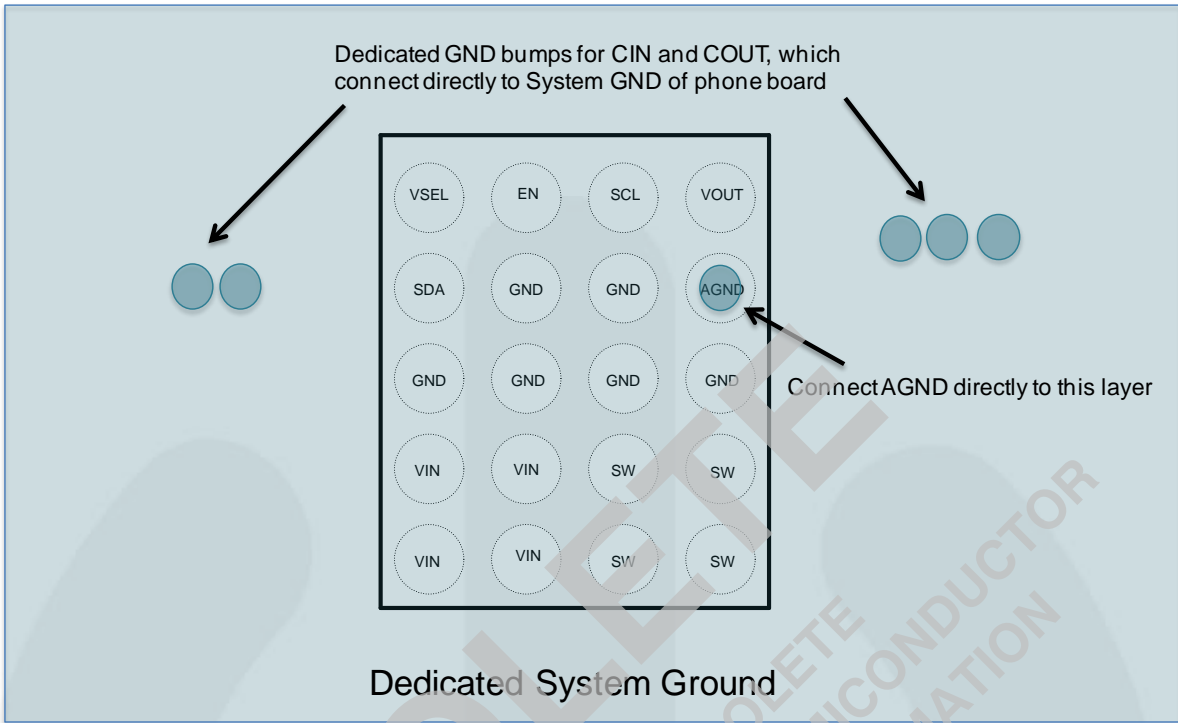
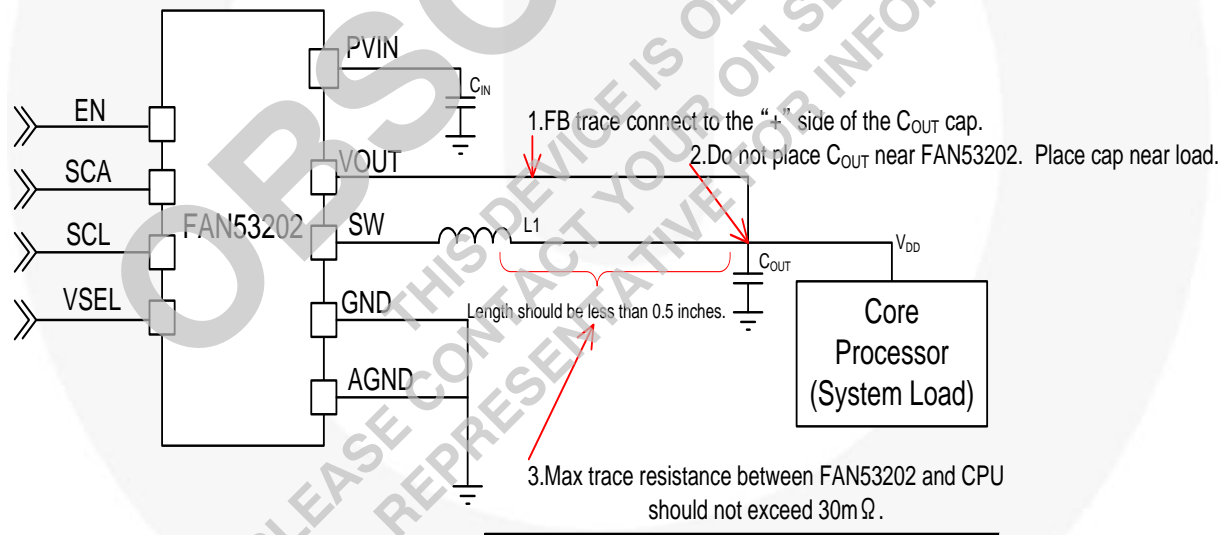

Figure 27. Guidance for Layer 3



The table provided for resistance for the given value of copper

| Width (mils) | Length (mils) | Copper (Oz) | Resistance (mΩ) |
|--------------|---------------|-------------|-----------------|
| 25 | 5000 | 2 | 4.2 |
| 25 | 500 | 1.5 | 4.9 |
| 25 | 500 | 1 | 5.8 |
| 25 | 500 | 0.5 | 7.6 |

Figure 28. Remote Sensing Schematic

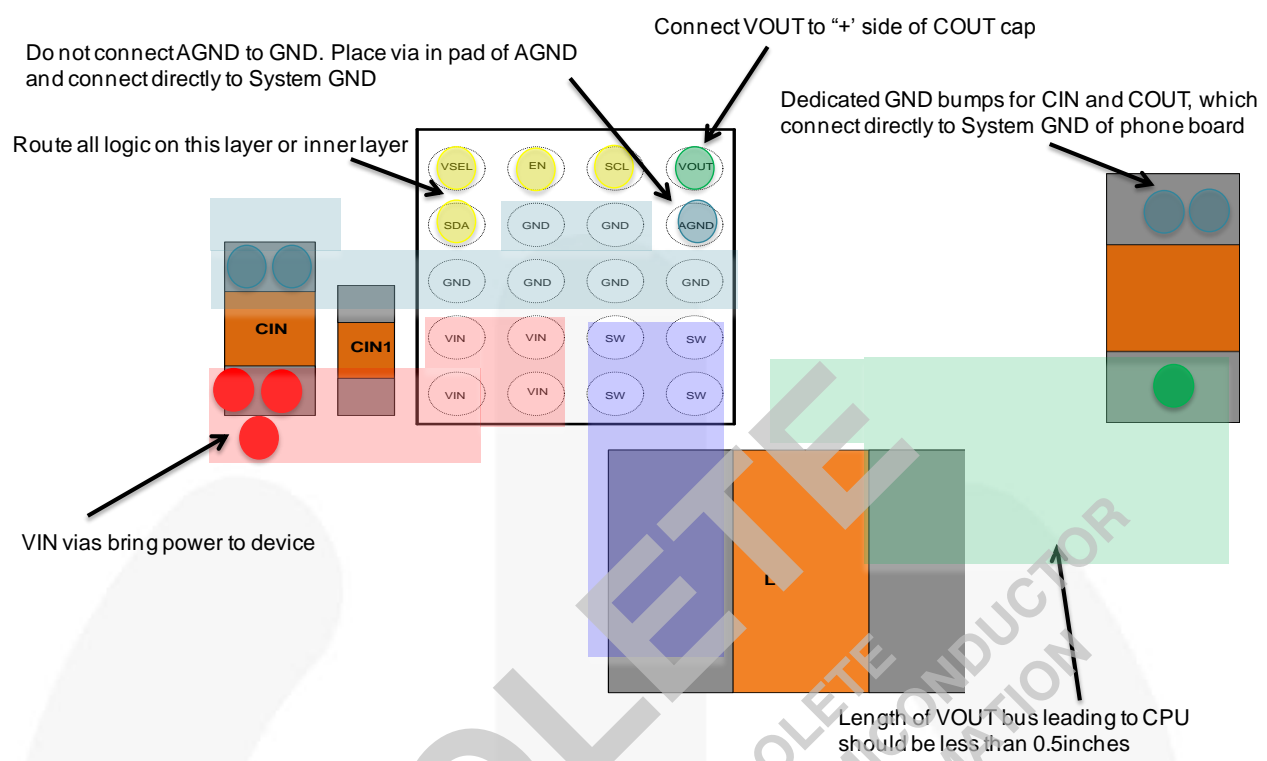

Figure 29. Remote Sensing Guidance, Top Layer

Physical Dimensions

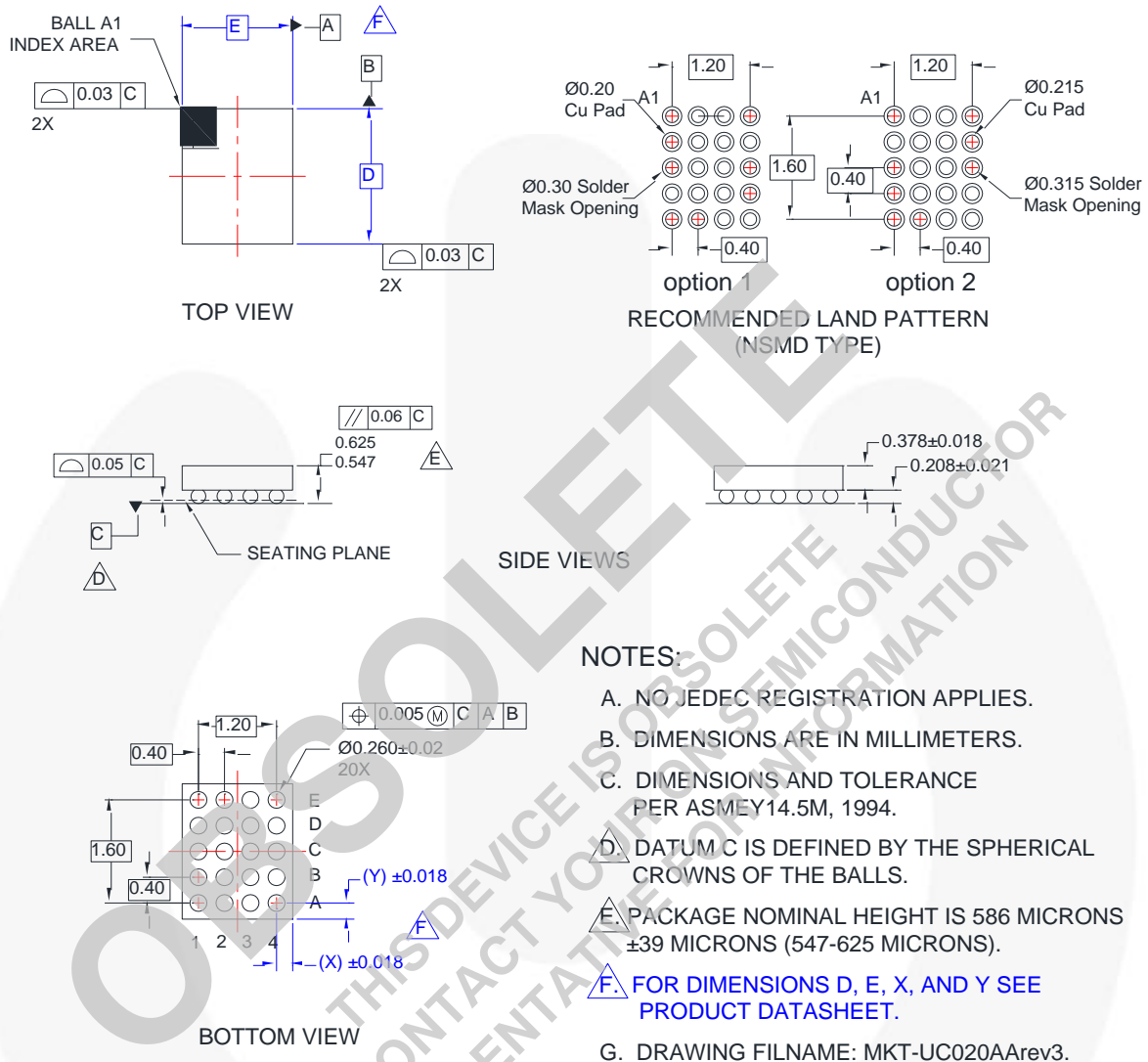

Figure 30. 20-Ball, Wafer-Level Chip-Scale Package (WLCSP), 4x5 Array, 0.4 mm Pitch, 250 µm Ball

Product-Specific Dimensions

| Product | D | E | X | Y |
|---------------|-------------|-------------|--------|--------|
| FAN53202UC23X | 2.015 ±0.03 | 1.615 ±0.03 | 0.2075 | 0.2075 |



TRADEMARKS

The following includes registered and unregistered trademarks and service marks, owned by Fairchild Semiconductor and/or its global subsidiaries, and is not intended to be an exhaustive list of all such trademarks.

- | | | | |
|--------------------------|--|---------------------------------------|------------------------------|
| AccuPower™ | F-PFS™ | OPTOPLANAR® | SYSTEM GENERAL ^{SP} |
| AttitudeEngine™ | FRFET® | ® | TinyBoost® |
| Awinda® | Global Power Resource SM | Power Supply WebDesigner™ | TinyBuck® |
| AX-CAP®* | GreenBridge™ | PowerTrench® | TinyCalc™ |
| BitSiC™ | Green FPS™ | PowerXS™ | TinyLogic® |
| Build it Now™ | Green FPS™ e-Series™ | Programmable Active Droop™ | TINYOPTO™ |
| CorePLUS™ | Gmax™ | QFET® | TinyPower™ |
| CorePOWER™ | GTO™ | QS™ | TinyPWM™ |
| CROSSVOLT™ | IntelliMAX™ | Quiet Series™ | TinyWire™ |
| CTL™ | ISOPLANAR™ | RapidConfigure™ | TranSiC™ |
| Current Transfer Logic™ | Making Small Speakers Sound Louder and Better™ | ® | TriFault Detect™ |
| DEUXPEED® | MegaBuck™ | Saving our world, 1mW/Wk/W at a time™ | TRUECURRENT®* |
| Dual Cool™ | MICROCOUPLER™ | SignalWise™ | µSerDes™ |
| EcoSPARK® | MicroFET™ | SmartMax™ | ® |
| EfficientMax™ | MicroPak™ | SMART START™ | UHC® |
| ESBC™ | MicroPak2™ | Solutions for Your Success™ | Ultra FRFET™ |
| F ® | MillerDrive™ | SPM® | UniFET™ |
| Fairchild® | MotionMax™ | STEALTH™ | VCO™ |
| Fairchild Semiconductor® | MotionGrid® | SuperFET® | VisualMax™ |
| FACT Quiet Series™ | MTi® | SuperSOT™-3 | VoltagePlus™ |
| FACT® | MTX® | SuperSOT™-6 | XS™ |
| FAST® | MVN® | SuperSOT™-8 | Xsens™ |
| FastvCore™ | mWSaver® | SupreMOS® | 仙童™ |
| FETBench™ | OptoHit™ | SyncFET™ | |
| FPS™ | OPTOLOGIC® | Sync-Lock™ | |

* Trademarks of System General Corporation, used under license by Fairchild Semiconductor.

DISCLAIMER

FAIRCHILD SEMICONDUCTOR RESERVES THE RIGHT TO MAKE CHANGES WITHOUT FURTHER NOTICE TO ANY PRODUCTS HEREIN TO IMPROVE RELIABILITY, FUNCTION, OR DESIGN. TO OBTAIN THE LATEST, MOST UP-TO-DATE DATASHEET AND PRODUCT INFORMATION, VISIT OUR WEBSITE AT [HTTP://WWW.FAIRCHILDSEMI.COM](http://www.fairchildsemi.com). FAIRCHILD DOES NOT ASSUME ANY LIABILITY ARISING OUT OF THE APPLICATION OR USE OF ANY PRODUCT OR CIRCUIT DESCRIBED HEREIN; NEITHER DOES IT CONVEY ANY LICENSE UNDER ITS PATENT RIGHTS, NOR THE RIGHTS OF OTHERS. THESE SPECIFICATIONS DO NOT EXPAND THE TERMS OF FAIRCHILD'S WORLDWIDE TERMS AND CONDITIONS, SPECIFICALLY THE WARRANTY THEREIN, WHICH COVERS THESE PRODUCTS.

LIFE SUPPORT POLICY

FAIRCHILD'S PRODUCTS ARE NOT AUTHORIZED FOR USE AS CRITICAL COMPONENTS IN LIFE SUPPORT DEVICES OR SYSTEMS WITHOUT THE EXPRESS WRITTEN APPROVAL OF FAIRCHILD SEMICONDUCTOR CORPORATION.

As used herein:

1. Life support devices or systems are devices or systems which (a) are intended for surgical implant into the body or (b) support or sustain life, and (c) whose failure to perform when properly used in accordance with instructions for use provided in the labeling, can be reasonably expected to result in a significant injury of the user.
2. A critical component in any component of a life support, device, or system whose failure to perform can be reasonably expected to cause the failure of the life support device or system, or to affect its safety or effectiveness.

ANTI-COUNTERFEITING POLICY

Fairchild Semiconductor Corporation's Anti-Counterfeiting Policy. Fairchild's Anti-Counterfeiting Policy is also stated on our external website, www.fairchildsemi.com, under Sales Support.

Counterfeiting of semiconductor parts is a growing problem in the industry. All manufacturers of semiconductor products are experiencing counterfeiting of their parts. Customers who inadvertently purchase counterfeit parts experience many problems such as loss of brand reputation, substandard performance, failed applications, and increased cost of production and manufacturing delays. Fairchild is taking strong measures to protect ourselves and our customers from the proliferation of counterfeit parts. Fairchild strongly encourages customers to purchase Fairchild parts either directly from Fairchild or from Authorized Fairchild Distributors who are listed by country on our web page cited above. Products customers buy either from Fairchild directly or from Authorized Fairchild Distributors are genuine parts, have full traceability, meet Fairchild's quality standards for handling and storage and provide access to Fairchild's full range of up-to-date technical and product information. Fairchild and our Authorized Distributors will stand behind all warranties and will appropriately address any warranty issues that may arise. Fairchild will not provide any warranty coverage or other assistance for parts bought from Unauthorized Sources. Fairchild is committed to combat this global problem and encourage our customers to do their part in stopping this practice by buying direct or from authorized distributors.

PRODUCT STATUS DEFINITIONS

Definition of Terms

| Datasheet Identification | Product Status | Definition |
|--------------------------|-----------------------|---|
| Advance Information | Formative / In Design | Datasheet contains the design specifications for product development. Specifications may change in any manner without notice. |
| Preliminary | First Production | Datasheet contains preliminary data; supplementary data will be published at a later date. Fairchild Semiconductor reserves the right to make changes at any time without notice to improve design. |
| No Identification Needed | Full Production | Datasheet contains final specifications. Fairchild Semiconductor reserves the right to make changes at any time without notice to improve the design. |
| Obsolete | Not In Production | Datasheet contains specifications on a product that is discontinued by Fairchild Semiconductor. The datasheet is for reference information only. |

Rev. I74

OBSOLETE
THIS DEVICE IS OBSOLETE
PLEASE CONTACT YOUR ON SEMICONDUCTOR
REPRESENTATIVE FOR INFORMATION

ON Semiconductor and  are trademarks of Semiconductor Components Industries, LLC dba ON Semiconductor or its subsidiaries in the United States and/or other countries. ON Semiconductor owns the rights to a number of patents, trademarks, copyrights, trade secrets, and other intellectual property. A listing of ON Semiconductor's product/patent coverage may be accessed at www.onsemi.com/site/pdf/Patent-Marking.pdf. ON Semiconductor reserves the right to make changes without further notice to any products herein. ON Semiconductor makes no warranty, representation or guarantee regarding the suitability of its products for any particular purpose, nor does ON Semiconductor assume any liability arising out of the application or use of any product or circuit, and specifically disclaims any and all liability, including without limitation special, consequential or incidental damages. Buyer is responsible for its products and applications using ON Semiconductor products, including compliance with all laws, regulations and safety requirements or standards, regardless of any support or applications information provided by ON Semiconductor. "Typical" parameters which may be provided in ON Semiconductor data sheets and/or specifications can and do vary in different applications and actual performance may vary over time. All operating parameters, including "Typicals" must be validated for each customer application by customer's technical experts. ON Semiconductor does not convey any license under its patent rights nor the rights of others. ON Semiconductor products are not designed, intended, or authorized for use as a critical component in life support systems or any FDA Class 3 medical devices or medical devices with a same or similar classification in a foreign jurisdiction or any devices intended for implantation in the human body. Should Buyer purchase or use ON Semiconductor products for any such unintended or unauthorized application, Buyer shall indemnify and hold ON Semiconductor and its officers, employees, subsidiaries, affiliates, and distributors harmless against all claims, costs, damages, and expenses, and reasonable attorney fees arising out of, directly or indirectly, any claim of personal injury or death associated with such unintended or unauthorized use, even if such claim alleges that ON Semiconductor was negligent regarding the design or manufacture of the part. ON Semiconductor is an Equal Opportunity/Affirmative Action Employer. This literature is subject to all applicable copyright laws and is not for resale in any manner.

PUBLICATION ORDERING INFORMATION

LITERATURE FULFILLMENT:

Literature Distribution Center for ON Semiconductor
19521 E. 32nd Pkwy, Aurora, Colorado 80011 USA
Phone: 303-675-2175 or 800-344-3860 Toll Free USA/Canada
Fax: 303-675-2176 or 800-344-3867 Toll Free USA/Canada
Email: orderlit@onsemi.com

N. American Technical Support: 800-282-9855 Toll Free
USA/Canada
Europe, Middle East and Africa Technical Support:
Phone: 421 33 790 2910
Japan Customer Focus Center
Phone: 81-3-5817-1050

ON Semiconductor Website: www.onsemi.com
Order Literature: <http://www.onsemi.com/orderlit>
For additional information, please contact your local
Sales Representative

X-ON Electronics

Largest Supplier of Electrical and Electronic Components

Click to view similar products for [Switching Voltage Regulators](#) category:

Click to view products by [ON Semiconductor](#) manufacturer:

Other Similar products are found below :

[FAN53610AUC33X](#) [FAN53611AUC123X](#) [FAN48610BUC33X](#) [FAN48610BUC45X](#) [FAN48617UC50X](#) [R3](#) [430464BB](#) [KE177614](#)
[MAX809TTR](#) [NCV891234MW50R2G](#) [NCP81103MNTXG](#) [NCP81203PMNTXG](#) [NCP81208MNTXG](#) [NCP81109GMNTXG](#)
[SCY1751FCCT1G](#) [NCP81109JMNTXG](#) [AP3409ADNTR-G1](#) [NCP81241MNTXG](#) [LTM8064IY](#) [LT8315EFE#TRPBF](#) [LTM4668AIY#PBF](#)
[NCV1077CSTBT3G](#) [XCL207A123CR-G](#) [MPM54304GMN-0002](#) [MPM54304GMN-0003](#) [XDPE132G5CG000XUMA1](#) [MP8757GL-P](#)
[MIC23356YFT-TR](#) [LD8116CGL](#) [HG2269M/TR](#) [OB2269](#) [XD3526](#) [U6215A](#) [U6215B](#) [U6620S](#) [LTC3412IFE](#) [LT1425IS](#)
[MAX25203BATJA/VY+](#) [MAX77874CEWM+](#) [XC9236D08CER-G](#) [ISL95338IRTZ](#) [MP3416GJ-P](#) [BD9S201NUX-CE2](#) [MP5461GC-Z](#)
[MPQ4415AGQB-Z](#) [MPQ4590GS-Z](#) [MCP1603-330IMC](#) [MCP1642B-18IMC](#) [MCP1642D-ADJIMC](#) [MCP1642D-18IMC](#)