

LED Driver, Series Boost, with Integrated Schottky Diode and Single-Wire Digital Interface

FAN5341

Description

The FAN5341 is an asynchronous constant-current LED driver capable of efficiently delivering up to 500 mW to a string of up to five LEDs in series. Optimized for small form-factor applications, the 1.2 MHz fixed switching frequency allows the use of small chip inductors and capacitors.

The FAN5341 uses a simple single-wire digital control interface to program the brightness levels of the LEDs in 32 linear steps by applying digital pulses.

For safety, the device features integrated over-voltage, over-current, short-circuit detection, and thermal-shutdown protection. In addition, input under-voltage lockout protection is triggered if the battery voltage is too low.

The FAN5341 is available in a very low profile, small form-factor 2 mm x 2 mm x 0.55 mm 6-lead UMLP package that is green and RoHS compliant.

Features

- Asynchronous Boost Converter
- Internal Schottky Diode
- Up to 500 mW Output Power
- Drives 3 to 5 LEDs in Series
- 2.7 V to 5.5 V Input Voltage Range
- Single-Wire Digital Control Interface to Set LED Brightness Levels
 - ◆ 32 Linear Steps
- 1.2 MHz Fixed Switching Frequency
- Soft-Start Capability
- Input Under-Voltage Lockout (UVLO)
- Output Over-Voltage Protection (OVP)
- Short-Circuit Detection
- Thermal Shutdown (TSD) Protection
- Low Profile 6-lead 2.0 x 2.0 x 0.55 mm UMLP Package
- This Device is Pb-Free, Halogen Free/BFR Free and is RoHS Compliant

Applications

- Cellular Mobile Handsets
- Mobile Internet Devices
- Portable Media Players
- PDA, DSC, MP3 Players



ON Semiconductor®

www.onsemi.com

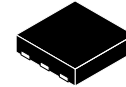

UDFN6 2 x 2, 0.65P
CASE 517DS

MARKING DIAGRAM

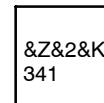

&Z = Assembly Plant Code
&2 = 2-Digit Date Code
&K = Lot Code
341 = Specific Device Code

ORDERING INFORMATION

See detailed ordering and shipping information on page 2 of this data sheet.

FAN5341

Table 1. ORDERING INFORMATION

Part Number	Temperature Range	Package	Packing Method [†]
FAN5341UMPX	-40°C to 85°C	6-lead, 2.0 x 2.0 mm UMLP	3000 / Tape & Reel

[†]For information on tape and reel specifications, including part orientation and tape sizes, please refer to our Tape and Reel Packaging Specifications Brochure, BRD8011/D.

TYPICAL APPLICATION DIAGRAM

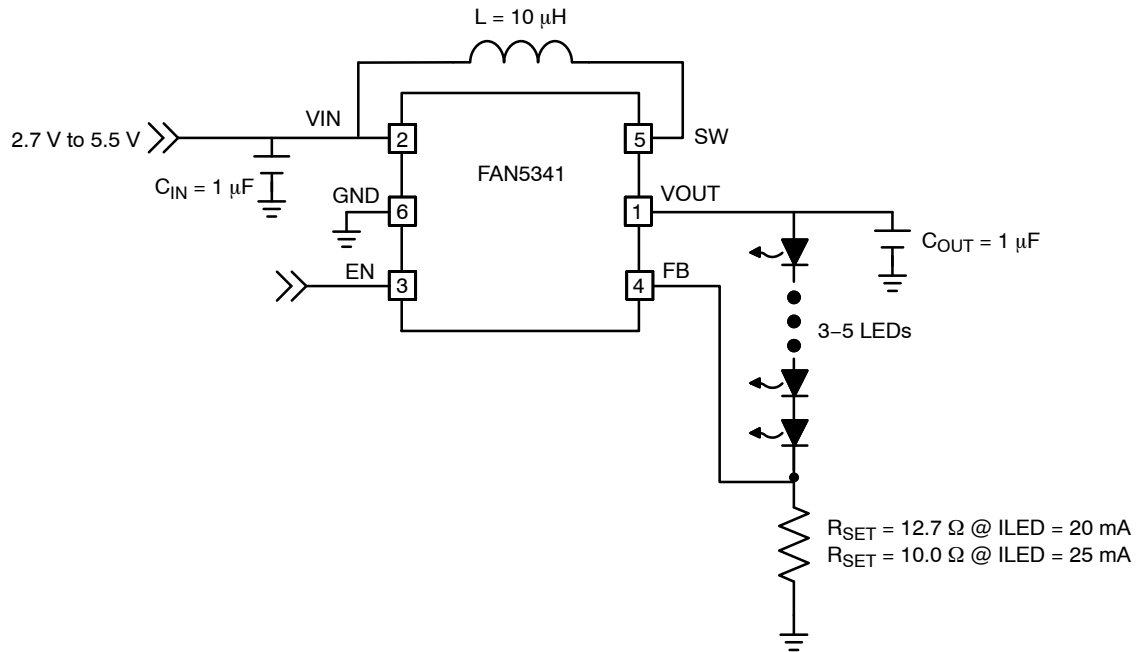

Figure 1. Typical Application

BLOCK DIAGRAM

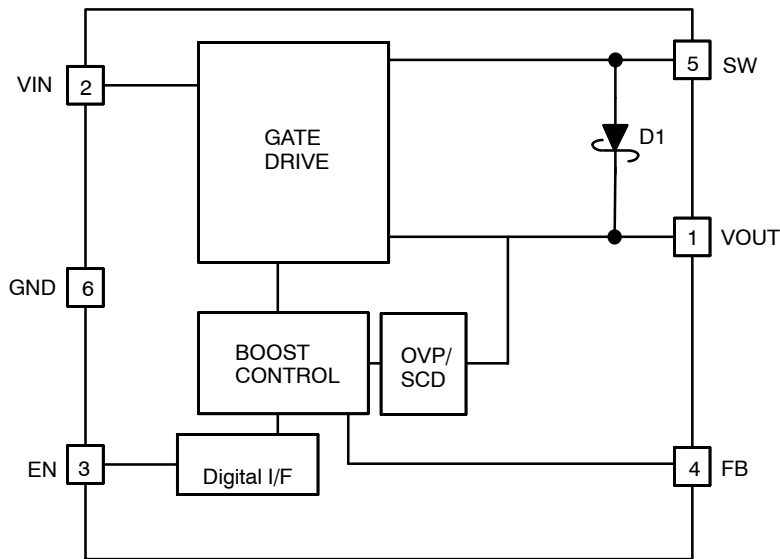

Figure 2. Functional Block Diagram

FAN5341

PIN CONFIGURATION

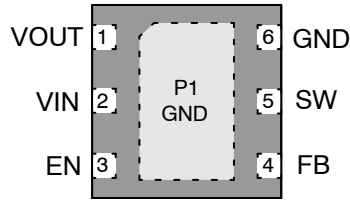

Figure 3. UMLP6 Package (Top View)

Table 2. PIN DEFINITIONS

Pin #	Name	Description
1	VOUT	Boost Output Voltage. Output of the boost regulator. Connect the LEDs to this pin. Connect C _{OUT} (Output Capacitor) to GND.
2	VIN	Input Voltage. Connect to power source and decouple with C _{IN} to GND.
3	EN	Enable Brightness Control. Program dimming levels by driving pin with digital pulses.
4	FB	Voltage Feedback. The boost regulator regulates this pin to 0.253 V to control the LED string current. Tie this pin to a current setting resistor (R _{SET}) between GND and the cathode of the LED string.
5	SW	Switching node. Tie inductor L1 from VIN to SW pin.
6	GND	Ground. Tie directly to a GND plane.

Table 3. ABSOLUTE MAXIMUM RATINGS

Symbol	Parameter	Min.	Max.	Units
V _{IN}	VIN Pin	-0.3	6.0	V
V _{FB} , V _{EN}	FB, EN Pins	-0.3	V _{IN} + 0.3	V
V _{SW}	SW Pin	-0.3	22.0	V
V _{OUT}	VOUT Pin	-0.3	22.0	V
ESD	Electrostatic Discharge Protection Level	Human Body Model per JESD22-A114	3.3	kV
		Charged Device Model per JESD22-C101	2.0	
T _J	Junction Temperature	-40	+150	°C
T _{STG}	Storage Temperature	-65	+150	°C
T _L	Lead Soldering Temperature, 10 Seconds		+260	°C

Stresses exceeding those listed in the Maximum Ratings table may damage the device. If any of these limits are exceeded, device functionality should not be assumed, damage may occur and reliability may be affected.

Table 4. RECOMMENDED OPERATING CONDITIONS

Symbol	Parameter	Min.	Max.	Units
V _{IN}	V _{IN} Supply Voltage	2.7	5.5	V
V _{OUT}	VOUT Voltage (Note 1)	6.2	17.5	V
I _{OUT}	VOUT Load Current	5	25	mA
T _A	Ambient Temperature	-40	+85	°C
T _J	Junction Temperature	-40	+125	°C

Functional operation above the stresses listed in the Recommended Operating Ranges is not implied. Extended exposure to stresses beyond the Recommended Operating Ranges limits may affect device reliability.

- Application should guarantee that minimum and maximum duty-cycle should fall between 20–85% to meet the specified range.

FAN5341

Table 5. THERMAL PROPERTIES

Symbol	Parameter	Typical	Units
θ_{JA}	Junction-to-Ambient Thermal Resistance, UMLP6 Package	70	$^{\circ}\text{C}/\text{W}$

NOTE: Junction-to-ambient thermal resistance is a function of application and board layout. This data is measured with four-layer 2s2p boards in accordance to JEDEC standard JESD51. Special attention must be paid not to exceed junction temperature $T_{J(\text{max})}$ at a given ambient temperature T_A .

Table 6. ELECTRICAL SPECIFICATIONS

($V_{IN} = 2.7\text{ V}$ to 5.5 V and $T_A = -40^{\circ}\text{C}$ to $+85^{\circ}\text{C}$ unless otherwise noted. Typical values are at $T_A = 25^{\circ}\text{C}$ and $V_{IN} = 3.6\text{ V}$.)

Symbol	Parameter	Conditions	Min	Typ	Max	Units
--------	-----------	------------	-----	-----	-----	-------

POWER SUPPLIES

I_{SD}	Shutdown Supply Current	$EN = \text{GND}, V_{IN} = 3.6\text{ V}$		0.30	0.75	μA
V_{UVLO}	Under-Voltage Lockout Threshold	V_{IN} Rising	2.10	2.35	2.60	V
		V_{IN} Falling	1.90	2.15	2.40	
V_{UVHYS}	Under-Voltage Lockout Hysteresis			250		mV

EN: ENABLE PIN

V_{IH}	HIGH-Level Input Voltage		1.2			V
V_{IL}	LOW-Level Input Voltage				0.4	V
R_{EN}	EN Pull-Down Resistance		200	300	400	$\text{k}\Omega$
T_{LO}	EN Low Time for Dimming	$V_{IN} = 3.6\text{ V}$; See Figure 14	0.5		300	μs
T_{HI}	Time Delay Between Steps	$V_{IN} = 3.6\text{ V}$; See Figure 14	0.5			μs
T_{SD}	EN Low, Shutdown Pulse Width	$V_{IN} = 3.6\text{ V}$; from Falling Edge of EN	1			ms

FEEDBACK AND REFERENCE

V_{FB}	Feedback Voltage	$I_{LED} = 20\text{ mA}$ from -40°C to $+85^{\circ}\text{C}$, $2.7\text{ V} \leq V_{IN} \leq 5.5\text{ V}$	240	253	266	mV
I_{FB}	Feedback Input Current	$V_{FB} = 253\text{ mV}$		0.1	1.0	μA

POWER OUTPUTS

$R_{DS(\text{ON})_Q1}$	Boost Switch On-Resistance	$V_{IN} = 3.6\text{ V}, I_{SW} = 100\text{ mA}$		600		$\text{m}\Omega$
		$V_{IN} = 2.7\text{ V}, I_{SW} = 100\text{ mA}$		650		
$I_{SW(\text{OFF})}$	SW Node Leakage (Note 2)	$EN = 0, V_{IN} = V_{SW} = V_{OUT} = 5.5\text{ V},$ $V_{LED} = 0$		0.1	2.0	μA
I_{LIM-PK}	Boost Switch Peak Current Limit	$V_{IN} = 3.6\text{ V}$		750		mA

OSCILLATOR

f_{SW}	Boost Regulator Switching Frequency		1.0	1.2	1.4	MHz
----------	-------------------------------------	--	-----	-----	-----	-----

OUTPUT AND PROTECTION

V_{OVP}	Boost Output Over-Voltage Protection		18.0	18.9	21.0	V
	OVP Hysteresis			0.8		
V_{TLSC}	V_{OUT} Short Circuit Detection Threshold	V_{OUT} Falling		$V_{IN} - 1.4$		V
V_{THSC}	V_{OUT} Short Circuit Detection Threshold	V_{OUT} Rising		$V_{IN} - 1.2$		V
D_{MAX}	Maximum Boost Duty Cycle (Notes 3, 4)		85			%
D_{MIN}	Minimum Boost Duty Cycle (Notes 3, 4)				20	

FAN5341

Table 6. ELECTRICAL SPECIFICATIONS (continued)

(V_{IN} = 2.7 V to 5.5 V and T_A = -40°C to +85°C unless otherwise noted. Typical values are at T_A = 25°C and V_{IN} = 3.6 V.)

Symbol	Parameter	Conditions	Min	Typ	Max	Units
T_{TSD}	Thermal Shutdown			150		°C
T_{HYS}	Thermal Shutdown Hysteresis			35		°C

2. SW leakage current includes the leakage current of 2 internal switches, SW to GND and SW to VOUT.
3. Not tested in production and guaranteed by design.
4. Application should guarantee that minimum and maximum duty cycle should fall between 20–85% to meet the specified range.

ELECTRICAL SPECIFICATIONS

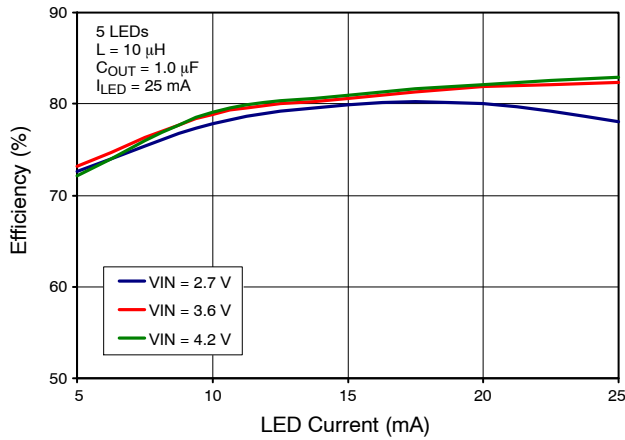

Figure 4. 5 LEDs: Efficiency vs. LED Current vs. Input Voltage

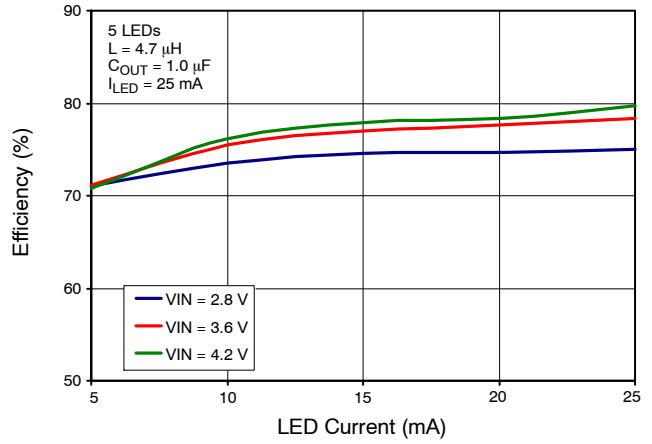

Figure 5. 5 LEDs: Efficiency vs. LED Current vs. Input Voltage

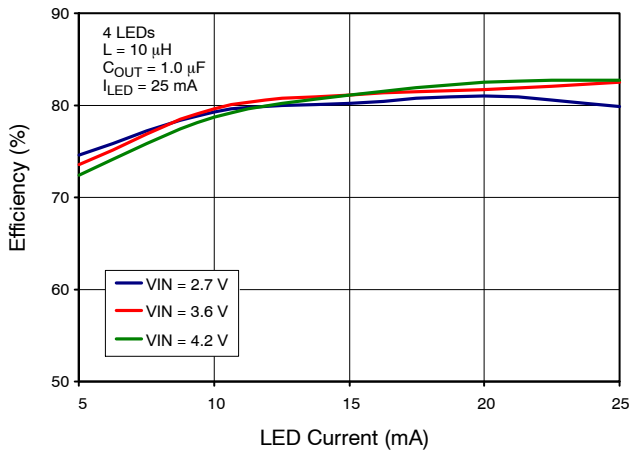

Figure 6. 4 LEDs: Efficiency vs. LED Current vs. Input Voltage

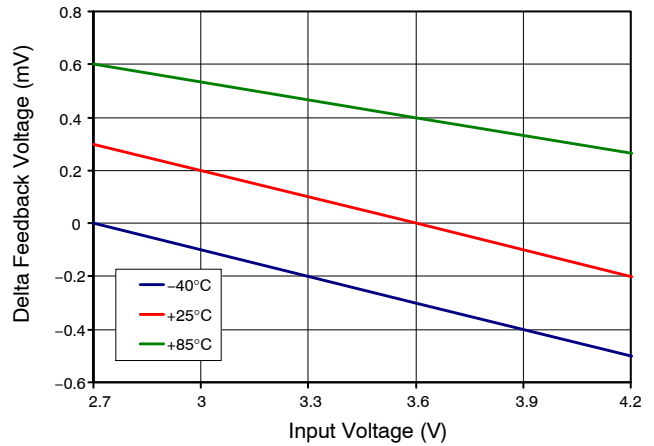

Figure 7. Delta of V_{FB} over Input Voltage and Temperature for 4 LEDs with $L = 10 \mu H$ and $C_{OUT} = 1.0 \mu F$ at $I_{LED} = 25 mA$

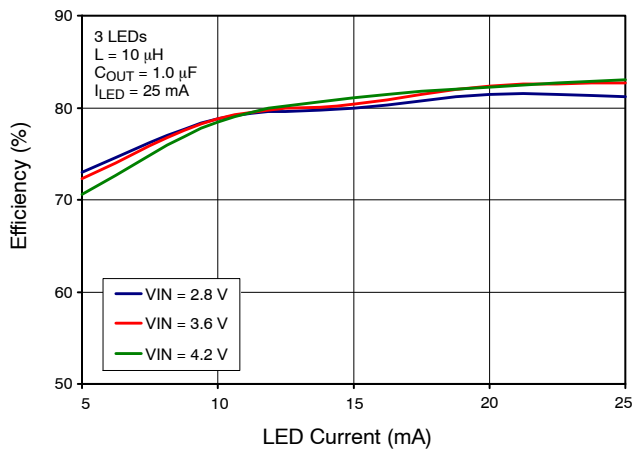

Figure 8. 3 LEDs: Efficiency vs. LED Current vs. Input Voltage

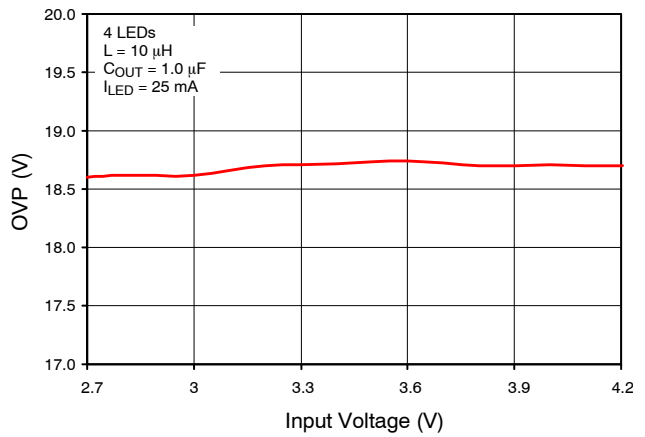

Figure 9. Over-Voltage Protection vs. Input Voltage

ELECTRICAL SPECIFICATIONS (continued)

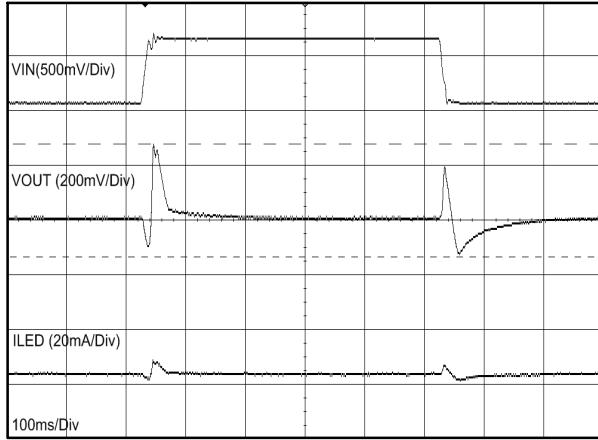

Figure 10. Line Transient Response for 4 LEDs at $V_{IN} = 3.6\text{ V} \pm 0.6\text{ V}$ with $L = 10\ \mu\text{H}$, $C_{OUT} = 1.0\ \mu\text{F}$ and $I_{LED} = 25\text{ mA}$

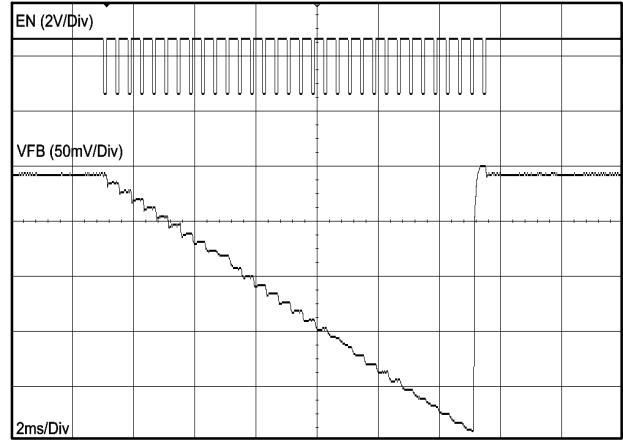

Figure 11. FAN5341 Dimming Operation at $V_{IN} = 3.6\text{ V}$ for 4 LEDs with $L = 10\ \mu\text{H}$, $C_{OUT} = 1.0\ \mu\text{F}$ and $I_{LED} = 25\text{ mA}$

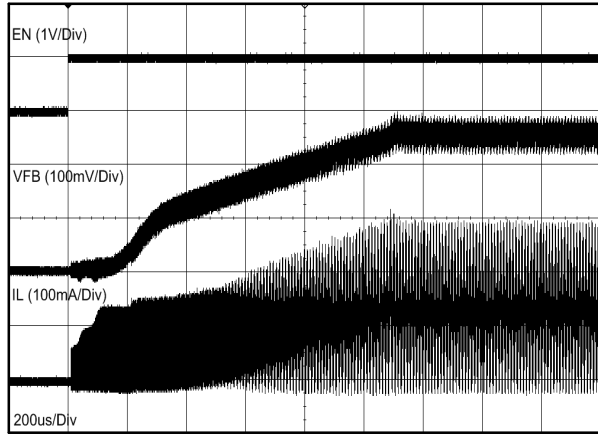

Figure 12. Startup Waveform for Switch Voltage, Inductor Current, V_{FB} and EN for 4 LEDs at $V_{IN} = 3.6\text{ V} \pm 0.6\text{ V}$ with $L = 10\ \mu\text{H}$, $C_{OUT} = 1.0\ \mu\text{F}$ and $I_{LED} = 25\text{ mA}$

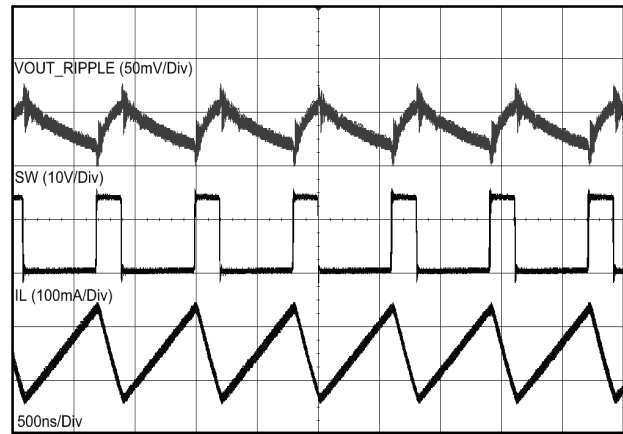

Figure 13. Steady-State Waveform for V_{OUT} , Switch Voltage and Inductor Current for 4 LEDs at $V_{IN} = 3.6\text{ V} \pm 0.6\text{ V}$ with $L = 10\ \mu\text{H}$, $C_{OUT} = 1.0\ \mu\text{F}$ and $I_{LED} = 25\text{ mA}$

CIRCUIT DESCRIPTION

Overview

The FAN5341 is an inductive current-mode boost serial LED driver that achieves LED current regulation by maintaining 0.253 V across the R_{SET} resistor. The current through the LED string (I_{LED}) is therefore given by:

$$I_{LED} = \frac{0.253}{R_{SET}} \quad (\text{eq. 1})$$

The voltage V_{OUT} is determined by the sum of the forward voltages across each LED, plus the voltage across R_{SET}, which is always 253 mV.

Driving Five LEDs in Series

FAN5341 can drive five LEDs in series but, the forward voltage (V_F) of the LED MUST be less than 3.5 V such that it remains under the over-voltage specification of 18.9 V.

UVLO and Soft-Start

If EN has been low for more than 1 ms, the IC may initiate a “cold start” soft-start cycle when EN rises, provided V_{IN} is above the UVLO threshold.

Digital Interface

The FAN5341 implements a single-wire digital interface to program the LED brightness to one of thirty-two (32) levels spaced in linear steps. With this single-wire solution, the FAN5341 does not require the system processor to constantly supply a signal to it to drive the LEDs.

Digital Dimming Control

The FAN5341 starts driving the LEDs at the maximum brightness level. After startup, the control logic is ready to accept programming pulses to decrease the brightness level by the number of positive edges applied to the EN pin. Figure 14 shows the digital pulse dimming control.

Over-Current and Short-Circuit Detection

The boost regulator employs a cycle-by-cycle peak inductor current limit of ~750 mA.

Over-Voltage / Open-Circuit Protection

If the LED string is an open circuit, FB remains at 0 V and the output voltage continues to increase in the absence of an over-voltage protection (OVP) circuit. The FAN5341’s OVP circuit disables the boost regulator when V_{OUT} exceeds 18.9 V and continues to keep the regulator off until V_{OUT} drops below 18.1 V.

Thermal Shutdown

When the die temperature exceeds 150°C, a reset occurs and remains in effect until the die cools to 125°C, at which time, the circuit is allowed to begin the soft-start sequence.

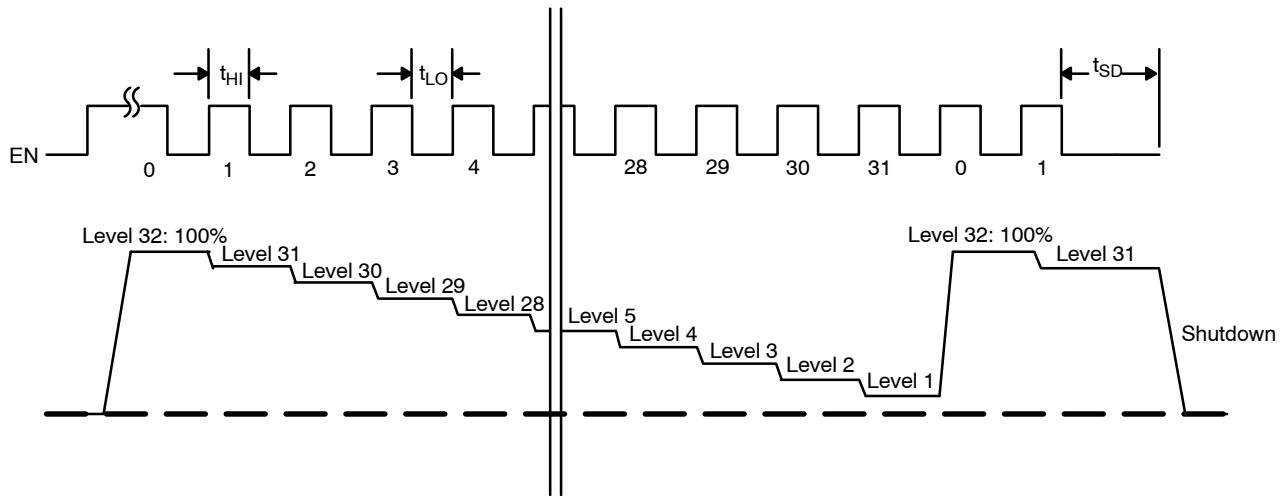

Figure 14. Digital Pulse-Dimming Control Diagram

APPLICATION INFORMATION

Inductor & Output Capacitor Selection

Table 7. RECOMMENDED EXTERNAL COMPONENTS

# of LEDs	Inductor (L)	Part Number	Manufacturer	Min C _{OUT}	Part Number	Manufacturer
3, 4, 5	10.0 μ H	LQH43MN100K03	Murata	1.00 μ F	CV105X5R105K25AT	AVX/Kyocera
		NLCV32T-100K-PFR	TDK			
		VLF3010AT-100MR49-1	TDK			
	4.7 μ H	LQH43MN4R7K03	Murata	1.00 μ F	CV105X5R105K25AT	AVX/Kyocera
		NLCV32T-4R7M-PFR	TDK			
		LPF2010T-4R7M	ABCO			

Component Placement and PCB Recommendations

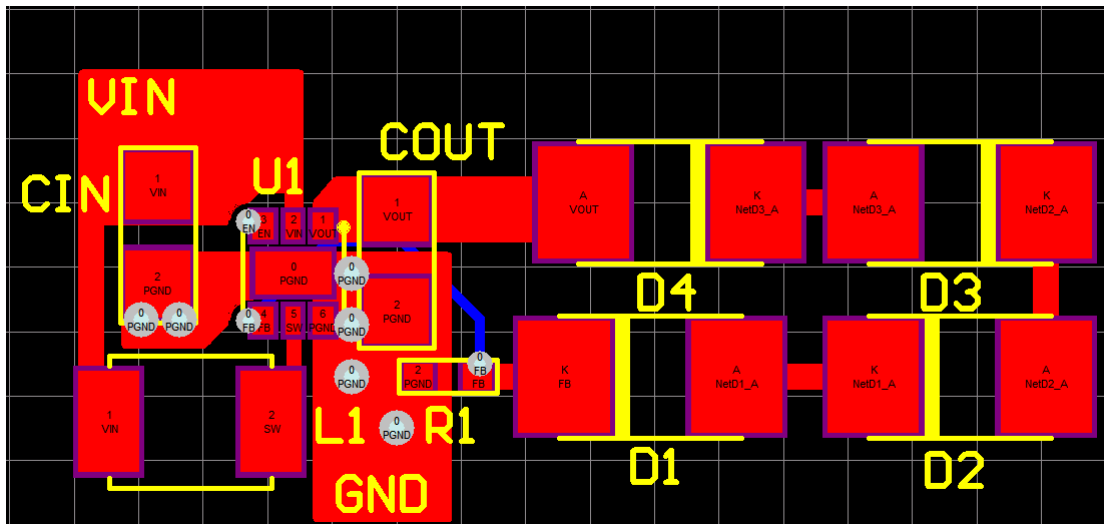

Figure 15. Recommended Component Placement

Input Capacitance

In a typical application, the input and output capacitors should be placed as close to the IC as possible; no additional capacitance is needed to ensure proper functionality. However, in a testing environment, where the FAN5341 is typically powered by a power supply with relatively long cables, an additional input capacitor (10 μ F) may be needed to ensure stable functioning. This capacitor should be placed close to where the power supply cables attach to the FAN5341 evaluation board.

PCB Recommendations

- The inductor can be connected to VIN with vias through another layer if needed.
- The feedback pin should be connected back to the IC on a sub-layer.



UDFN6 2x2, 0.65P
CASE 517DS
ISSUE O

DATE 31 OCT 2016

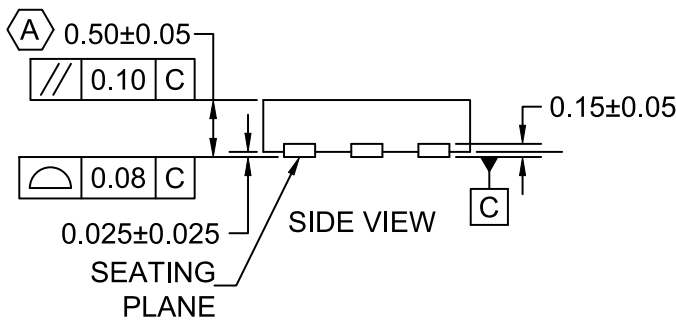
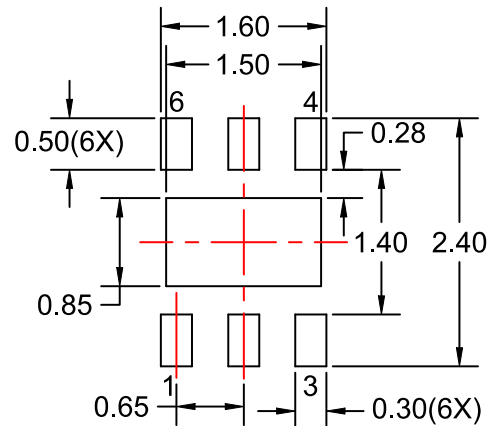
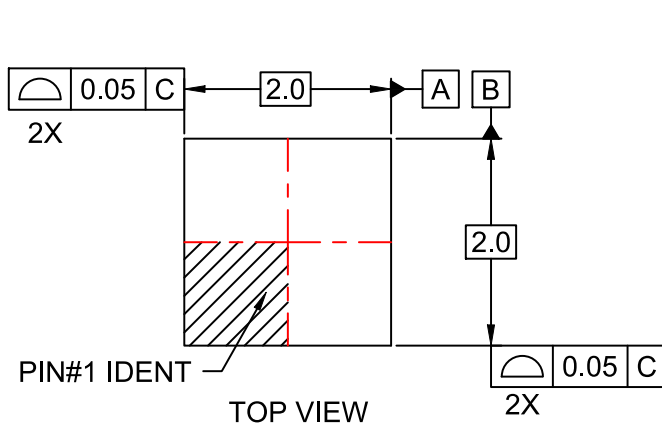

NOTES:

- A. CONFORM TO JADEC REGISTRATIONS MO-229, VARIATION VCCC, EXCEPT WHERE NOTED.
- B. DIMENSIONS ARE IN MILLIMETERS.
- C. DIMENSIONS AND TOLERANCES PER ASME Y14.5M, 2009.
- D. LAND PATTERN RECOMMENDATION IS EXISTING INDUSTRY LAND PATTERN.

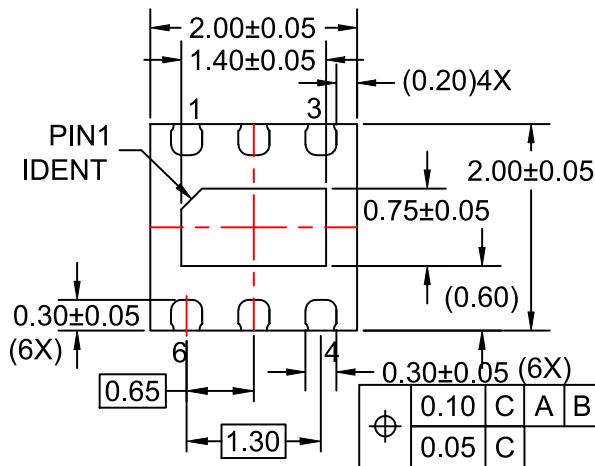

BOTTOM VIEW

DOCUMENT NUMBER:	98AON13697G	Electronic versions are uncontrolled except when accessed directly from the Document Repository. Printed versions are uncontrolled except when stamped "CONTROLLED COPY" in red.
DESCRIPTION:	UDFN6 2x2, 0.65P	PAGE 1 OF 1

ON Semiconductor and are trademarks of Semiconductor Components Industries, LLC dba ON Semiconductor or its subsidiaries in the United States and/or other countries. ON Semiconductor reserves the right to make changes without further notice to any products herein. ON Semiconductor makes no warranty, representation or guarantee regarding the suitability of its products for any particular purpose, nor does ON Semiconductor assume any liability arising out of the application or use of any product or circuit, and specifically disclaims any and all liability, including without limitation special, consequential or incidental damages. ON Semiconductor does not convey any license under its patent rights nor the rights of others.

onsemi, **Onsemi**, and other names, marks, and brands are registered and/or common law trademarks of Semiconductor Components Industries, LLC dba "**onsemi**" or its affiliates and/or subsidiaries in the United States and/or other countries. **onsemi** owns the rights to a number of patents, trademarks, copyrights, trade secrets, and other intellectual property. A listing of **onsemi**'s product/patent coverage may be accessed at www.onsemi.com/site/pdf/Patent-Marking.pdf. **onsemi** reserves the right to make changes at any time to any products or information herein, without notice. The information herein is provided "as-is" and **onsemi** makes no warranty, representation or guarantee regarding the accuracy of the information, product features, availability, functionality, or suitability of its products for any particular purpose, nor does **onsemi** assume any liability arising out of the application or use of any product or circuit, and specifically disclaims any and all liability, including without limitation special, consequential or incidental damages. Buyer is responsible for its products and applications using **onsemi** products, including compliance with all laws, regulations and safety requirements or standards, regardless of any support or applications information provided by **onsemi**. "Typical" parameters which may be provided in **onsemi** data sheets and/or specifications can and do vary in different applications and actual performance may vary over time. All operating parameters, including "Typicals" must be validated for each customer application by customer's technical experts. **onsemi** does not convey any license under any of its intellectual property rights nor the rights of others. **onsemi** products are not designed, intended, or authorized for use as a critical component in life support systems or any FDA Class 3 medical devices or medical devices with a same or similar classification in a foreign jurisdiction or any devices intended for implantation in the human body. Should Buyer purchase or use **onsemi** products for any such unintended or unauthorized application, Buyer shall indemnify and hold **onsemi** and its officers, employees, subsidiaries, affiliates, and distributors harmless against all claims, costs, damages, and expenses, and reasonable attorney fees arising out of, directly or indirectly, any claim of personal injury or death associated with such unintended or unauthorized use, even if such claim alleges that **onsemi** was negligent regarding the design or manufacture of the part. **onsemi** is an Equal Opportunity/Affirmative Action Employer. This literature is subject to all applicable copyright laws and is not for resale in any manner.

PUBLICATION ORDERING INFORMATION

LITERATURE FULFILLMENT:

Email Requests to: orderlit@onsemi.com

onsemi Website: www.onsemi.com

TECHNICAL SUPPORT

North American Technical Support:
Voice Mail: 1 800-282-9855 Toll Free USA/Canada
Phone: 011 421 33 790 2910

Europe, Middle East and Africa Technical Support:

Phone: 00421 33 790 2910

For additional information, please contact your local Sales Representative

X-ON Electronics

Largest Supplier of Electrical and Electronic Components

Click to view similar products for [LED Lighting Drivers](#) category:

Click to view products by [ON Semiconductor](#) manufacturer:

Other Similar products are found below :

[LV5235V-MPB-H](#) [MB39C602PNF-G-JNEFE1](#) [MIC2871YMK-T5](#) [AL1676-10BS7-13](#) [AL1676-20AS7-13](#) [AP5726WUG-7](#) [ICL8201](#)
[IS31BL3228B-UTLS2-TR](#) [IS31BL3506B-TTLS2-TR](#) [AL3157F-7](#) [AP5725FDCG-7](#) [AP5726FDCG-7](#) [LV52204MTTBG](#) [AP5725WUG-7](#)
[STP4CMPQTR](#) [NCL30086BDR2G](#) [CAT4004BHU2-GT3](#) [LV52207AXA-VH](#) [AP1694AS-13](#) [TLE4242EJ](#) [AS3688](#) [IS31LT3172-GRLS4-TR](#)
[TLD2311EL](#) [KTD2694EDQ-TR](#) [KTZ8864EJAA-TR](#) [IS32LT3174-GRLA3-TR](#) [MP2488DN-LF-Z](#) [NLM0010XTSA1](#) [AL1676-20BS7-13](#)
[ZXLD1370QESTTC](#) [MPQ7220GF-AEC1-P](#) [MPQ7220GR-AEC1-P](#) [MPQ4425BGJ-AEC1-P](#) [MPQ7220GF-AEC1-Z](#) [MPQ7220GR-AEC1-Z](#)
[MPQ4425BGJ-AEC1-Z](#) [NCL30486A2DR2G](#) [IS31FL3737B-QFLS4-TR](#) [IS31FL3239-QFLS4-TR](#) [KTD2058EUAC-TR](#) [KTD2037EWE-TR](#)
[DIO5662ST6](#) [IS31BL3508A-TTLS2-TR](#) [KTD2026BEWE-TR](#) [MAX20052CATC/V+](#) [MAX25606AUP/V+](#) [BD6586MUV-E2](#) [BD9206EFV-E2](#) [BD9416FS-E2](#) [LYT4227E](#)