

ON Semiconductor

Is Now

onsemi™

To learn more about onsemi™, please visit our website at
www.onsemi.com

onsemi and **onsemi** and other names, marks, and brands are registered and/or common law trademarks of Semiconductor Components Industries, LLC dba "**onsemi**" or its affiliates and/or subsidiaries in the United States and/or other countries. **onsemi** owns the rights to a number of patents, trademarks, copyrights, trade secrets, and other intellectual property. A listing of **onsemi** product/patent coverage may be accessed at www.onsemi.com/site/pdf/Patent-Marking.pdf. **onsemi** reserves the right to make changes at any time to any products or information herein, without notice. The information herein is provided "as-is" and **onsemi** makes no warranty, representation or guarantee regarding the accuracy of the information, product features, availability, functionality, or suitability of its products for any particular purpose, nor does **onsemi** assume any liability arising out of the application or use of any product or circuit, and specifically disclaims any and all liability, including without limitation special, consequential or incidental damages. Buyer is responsible for its products and applications using **onsemi** products, including compliance with all laws, regulations and safety requirements or standards, regardless of any support or applications information provided by **onsemi**. "Typical" parameters which may be provided in **onsemi** data sheets and/or specifications can and do vary in different applications and actual performance may vary over time. All operating parameters, including "Typicals" must be validated for each customer application by customer's technical experts. **onsemi** does not convey any license under any of its intellectual property rights nor the rights of others. **onsemi** products are not designed, intended, or authorized for use as a critical component in life support systems or any FDA Class 3 medical devices or medical devices with a same or similar classification in a foreign jurisdiction or any devices intended for implantation in the human body. Should Buyer purchase or use **onsemi** products for any such unintended or unauthorized application, Buyer shall indemnify and hold **onsemi** and its officers, employees, subsidiaries, affiliates, and distributors harmless against all claims, costs, damages, and expenses, and reasonable attorney fees arising out of, directly or indirectly, any claim of personal injury or death associated with such unintended or unauthorized use, even if such claim alleges that **onsemi** was negligent regarding the design or manufacture of the part. **onsemi** is an Equal Opportunity/Affirmative Action Employer. This literature is subject to all applicable copyright laws and is not for resale in any manner. Other names and brands may be claimed as the property of others.



ON Semiconductor®

FDB12N50F

N-Channel UniFET™ FRFET® MOSFET

500 V, 11.5 A, 700 mΩ

Features

- $R_{DS(on)} = 590\text{ m}\Omega$ (Typ.) @ $V_{GS} = 10\text{ V}$, $I_D = 6\text{ A}$
- Low Gate Charge (Typ. 21 nC)
- Low C_{rss} (Typ. 11 pF)
- 100% Avalanche Tested
- Improve dv/dt Capability
- RoHS Compliant

Applications

- Lighting
- Uninterruptible Power Supply
- AC-DC Power Supply

Description

UniFET™ MOSFET is ON Semiconductor's high voltage MOSFET family based on planar stripe and DMOS technology. This MOSFET is tailored to reduce on-state resistance, and to provide better switching performance and higher avalanche energy strength. The body diode's reverse recovery performance of UniFET FRFET® MOSFET has been enhanced by lifetime control. Its t_{rr} is less than 100nsec and the reverse dv/dt immunity is 15V/ns while normal planar MOSFETs have over 200nsec and 4.5V/nsec respectively. Therefore, it can remove additional component and improve system reliability in certain applications in which the performance of MOSFET's body diode is significant. This device family is suitable for switching power converter applications such as power factor correction (PFC), flat panel display (FPD) TV power, ATX and electronic lamp ballasts.

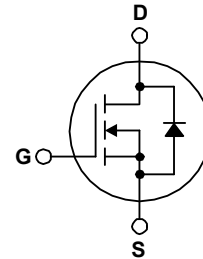
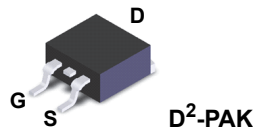

MOSFET Maximum Ratings $T_C = 25^\circ\text{C}$ unless otherwise noted.

Symbol	Parameter	FDB12N50FTM-WS	Unit
V_{DSS}	Drain to Source Voltage	500	V
V_{GSS}	Gate to Source Voltage	±30	V
I_D	Drain Current	- Continuous ($T_C = 25^\circ\text{C}$)	A
		- Continuous ($T_C = 100^\circ\text{C}$)	
I_{DM}	Drain Current	- Pulsed (Note 1)	A
E_{AS}	Single Pulsed Avalanche Energy	(Note 2)	mJ
I_{AR}	Avalanche Current	(Note 1)	A
E_{AR}	Repetitive Avalanche Energy	(Note 1)	mJ
dv/dt	Peak Diode Recovery dv/dt	(Note 3)	V/ns
P_D	Power Dissipation	($T_C = 25^\circ\text{C}$)	W
		- Derate above 25°C	1.33
T_J, T_{STG}	Operating and Storage Temperature Range	-55 to +150	$^\circ\text{C}$
T_L	Maximum Lead Temperature for Soldering Purpose, 1/8" from Case for 5 Seconds	300	$^\circ\text{C}$

Thermal Characteristics

Symbol	Parameter	FQB12N50FTM_WS	Unit
$R_{\theta JC}$	Thermal Resistance, Junction to Case, Max	0.75	$^\circ\text{C}/\text{W}$
$R_{\theta JA}$	Thermal Resistance, Junction to Ambient (minimum pad of 2 oz copper), Max.	62.5	
	Thermal Resistance, Junction to Ambient (1 in ² pad of 2 oz copper), Max.	40	

Package Marking and Ordering Information

Device Marking	Device	Package	Reel Size	Tape Width	Quantity
FDB12N50F	FDB12N50FTM_WS	D2-PAK	330mm	24mm	800 units

Electrical Characteristics $T_C = 25^\circ\text{C}$ unless otherwise noted.

Symbol	Parameter	Test Conditions	Min.	Typ.	Max.	Unit
--------	-----------	-----------------	------	------	------	------

Off Characteristics

BV_{DSS}	Drain to Source Breakdown Voltage	$I_D = 250\mu\text{A}, V_{GS} = 0\text{V}, T_J = 25^\circ\text{C}$	500	-	-	V
$\frac{\Delta BV_{DSS}}{\Delta T_J}$	Breakdown Voltage Temperature Coefficient	$I_D = 250\mu\text{A}$, Referenced to 25°C	-	0.5	-	$V/^\circ\text{C}$
I_{DSS}	Zero Gate Voltage Drain Current	$V_{DS} = 50\text{V}, V_{GS} = 0\text{V}$	-	-	10	μA
		$V_{DS} = 40\text{V}, T_C = 125^\circ\text{C}$	-	-	100	
I_{GSS}	Gate to Body Leakage Current	$V_{GS} = \pm 30\text{V}, V_{DS} = 0\text{V}$	-	-	± 100	nA

On Characteristics

$V_{GS(th)}$	Gate Threshold Voltage	$V_{GS} = V_{DS}, I_D = 250\mu\text{A}$	3.0	-	5.0	V
$R_{DS(on)}$	Static Drain to Source On Resistance	$V_{GS} = 10\text{V}, I_D = 6\text{A}$	-	0.59	0.7	Ω
g_{FS}	Forward Transconductance	$V_{DS} = 40\text{V}, I_D = 6\text{A}$	-	12	-	S

Dynamic Characteristics

C_{iss}	Input Capacitance	$V_{DS} = 25\text{V}, V_{GS} = 0\text{V}$ $f = 1\text{MHz}$	-	1050	1395	pF
C_{oss}	Output Capacitance		-	135	180	pF
C_{rss}	Reverse Transfer Capacitance		-	11	17	pF
$Q_{g(tot)}$	Total Gate Charge at 10V	$V_{DS} = 40\text{V}, I_D = 11.5\text{A}$ $V_{GS} = 10\text{V}$	-	21	30	nC
Q_{gs}	Gate to Source Gate Charge		-	6	-	nC
Q_{gd}	Gate to Drain "Miller" Charge		(Note 4)	-	9	-

Switching Characteristics

$t_{d(on)}$	Turn-On Delay Time	$V_{DD} = 250\text{V}, I_D = 11.5\text{A}$ $R_G = 25\Omega$	-	21	50	ns
t_r	Turn-On Rise Time		-	45	100	ns
$t_{d(off)}$	Turn-Off Delay Time		-	50	110	ns
t_f	Turn-Off Fall Time		(Note 4)	-	35	80

Drain-Source Diode Characteristics

I_S	Maximum Continuous Drain to Source Diode Forward Current	-	-	11.5	A	
I_{SM}	Maximum Pulsed Drain to Source Diode Forward Current	-	-	46	A	
V_{SD}	Drain to Source Diode Forward Voltage	$V_{GS} = 0\text{V}, I_{SD} = 11.5\text{A}$	-	-	1.5	V
t_{rr}	Reverse Recovery Time	$V_{GS} = 0\text{V}, I_{SD} = 11.5\text{A}$ $di_F/dt = 100\text{A}/\mu\text{s}$	-	134	-	ns
Q_{rr}	Reverse Recovery Charge		-	0.37	-	μC

Notes:

1. Repetitive Rating: Pulse width limited by maximum junction temperature
2. $L = 6.9\text{mH}, I_{AS} = 11.5\text{A}, V_{DD} = 50\text{V}, R_G = 25\Omega$, Starting $T_J = 25^\circ\text{C}$
3. $I_{SD} \leq 11.5\text{A}, di/dt \leq 200\text{A}/\mu\text{s}, V_{DD} \leq BV_{DSS}$, Starting $T_J = 25^\circ\text{C}$
4. Essentially Independent of Operating Temperature Typical Characteristics

Typical Characteristics

Figure 1. On-Region Characteristics

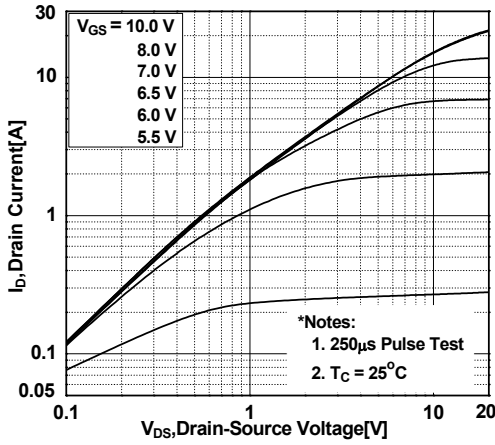

Figure 2. Transfer Characteristics

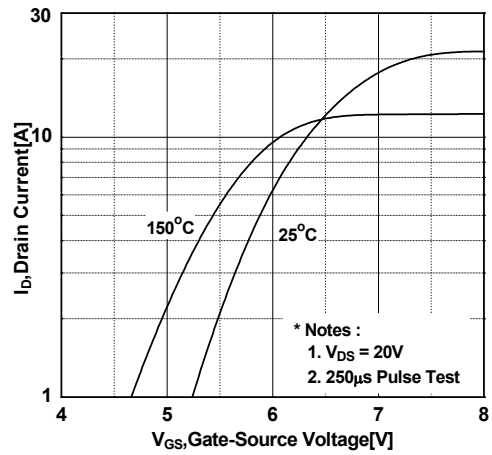

Figure 3. On-Resistance Variation vs. Drain Current and Gate Voltage

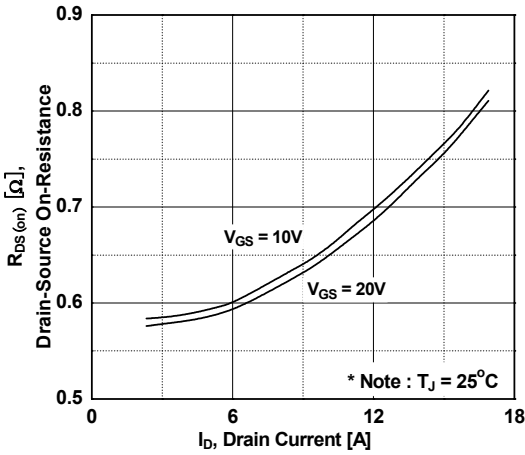

Figure 4. Body Diode Forward Voltage Variation vs. Source Current and Temperature

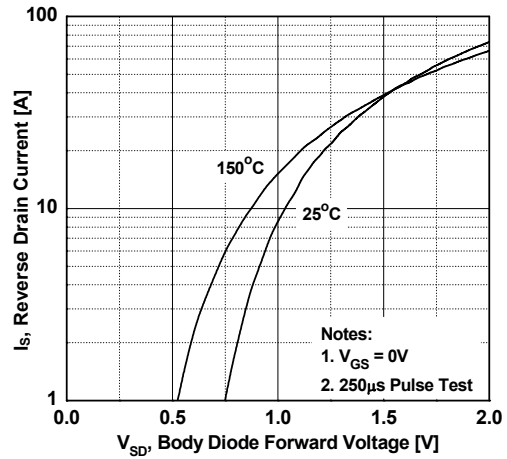

Figure 5. Capacitance Characteristics

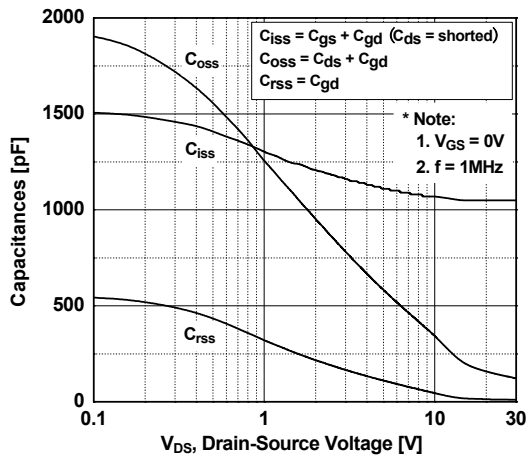
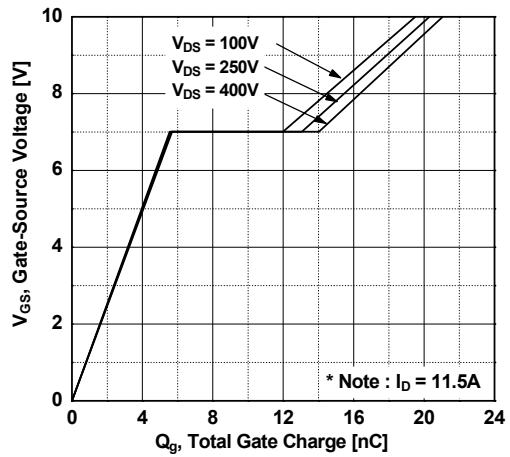

Figure 6. Gate Charge Characteristics



Typical Characteristics (Continued)

Figure 7. Breakdown Voltage Variation vs. Temperature

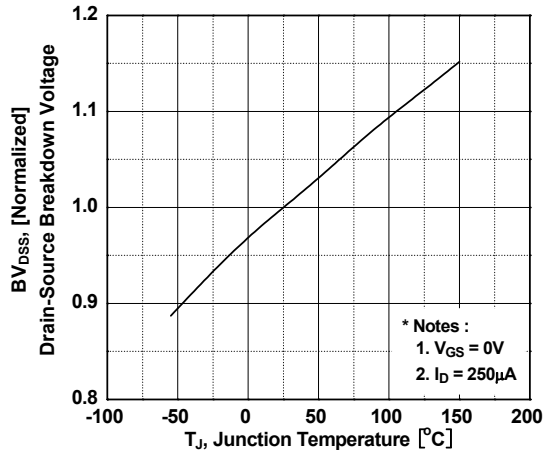

Figure 8. Maximum Safe Operating Area

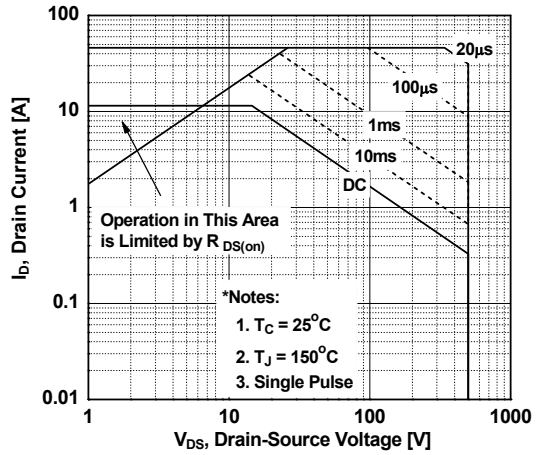

Figure 9. Maximum Drain Current vs. Case Temperature

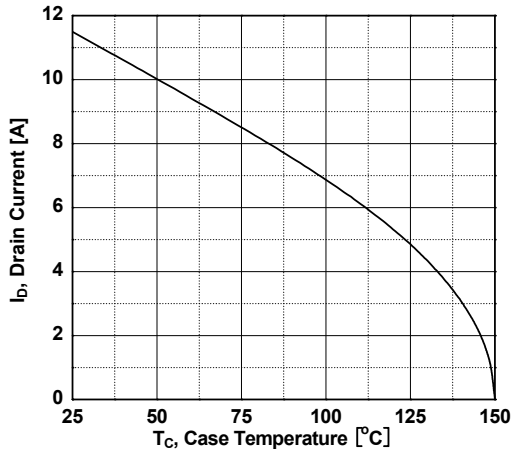

Figure 10. Transient Thermal Response Curve

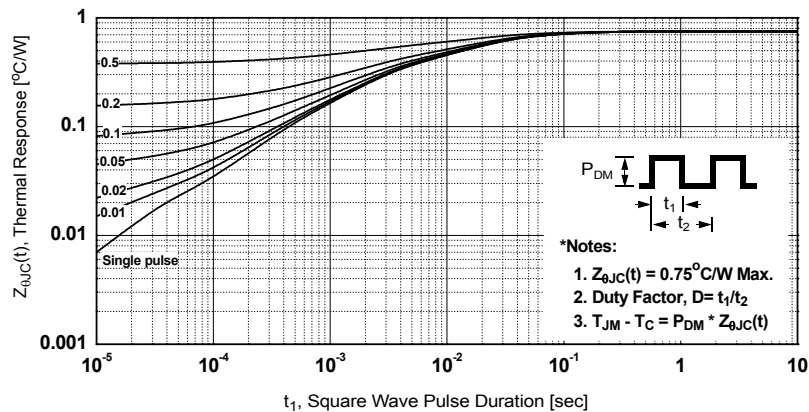

Figure 11. Gate Charge Test Circuit & Waveform

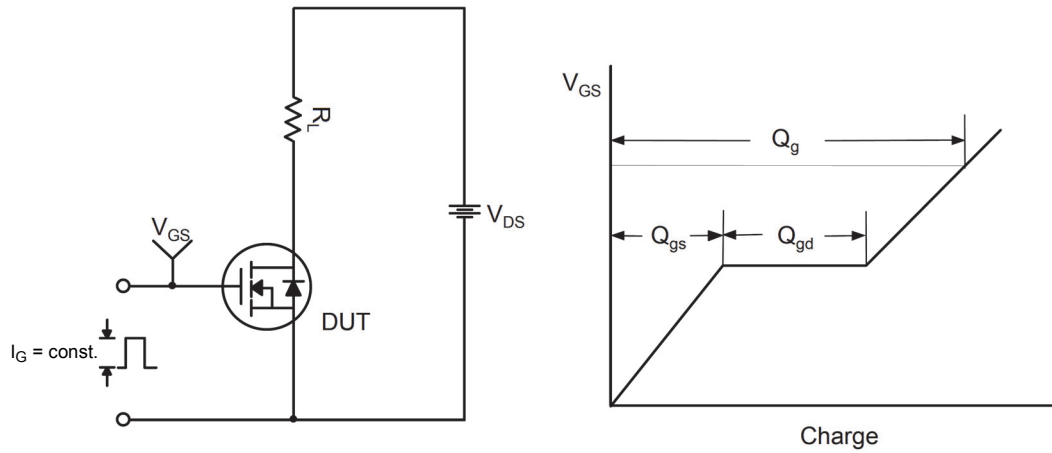

Figure 12. Resistive Switching Test Circuit & Waveforms

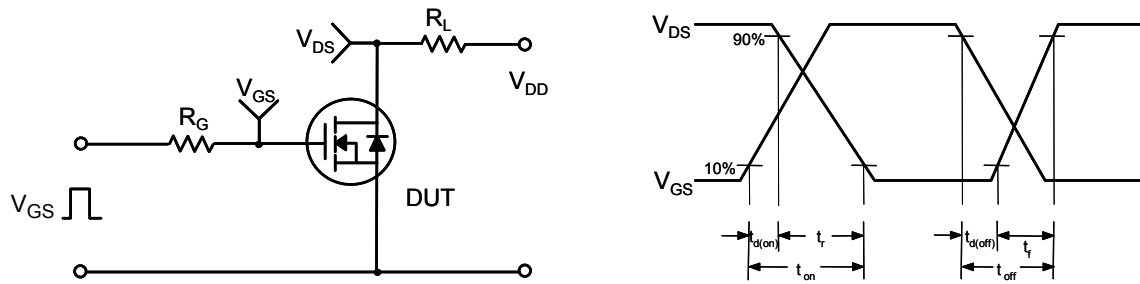

Figure 13. Unclamped Inductive Switching Test Circuit & Waveforms

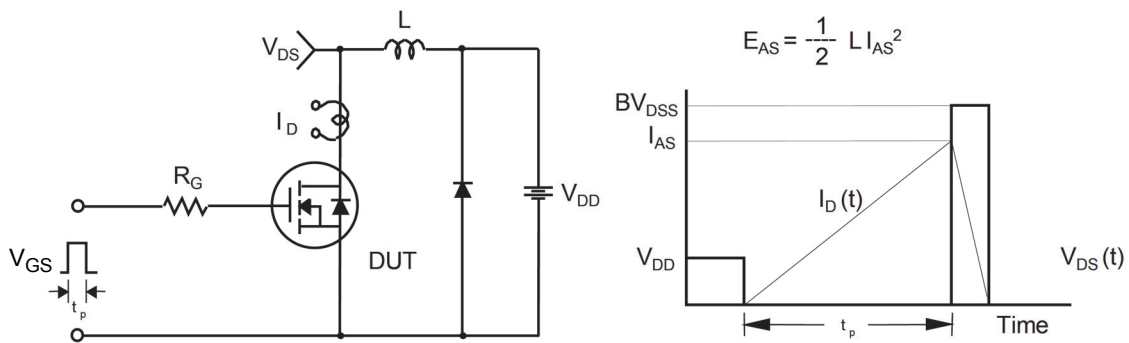
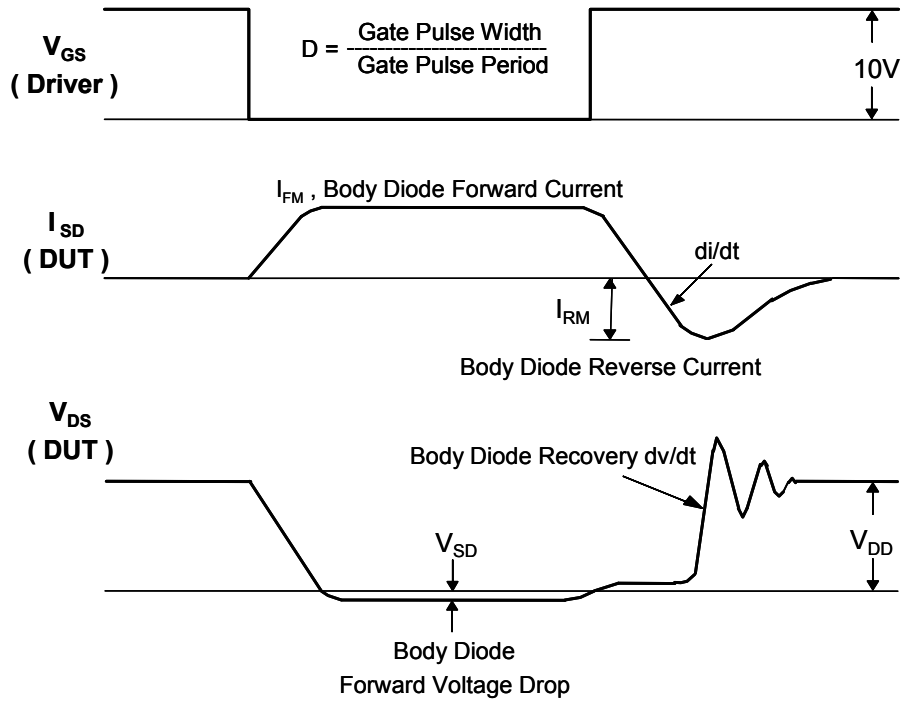
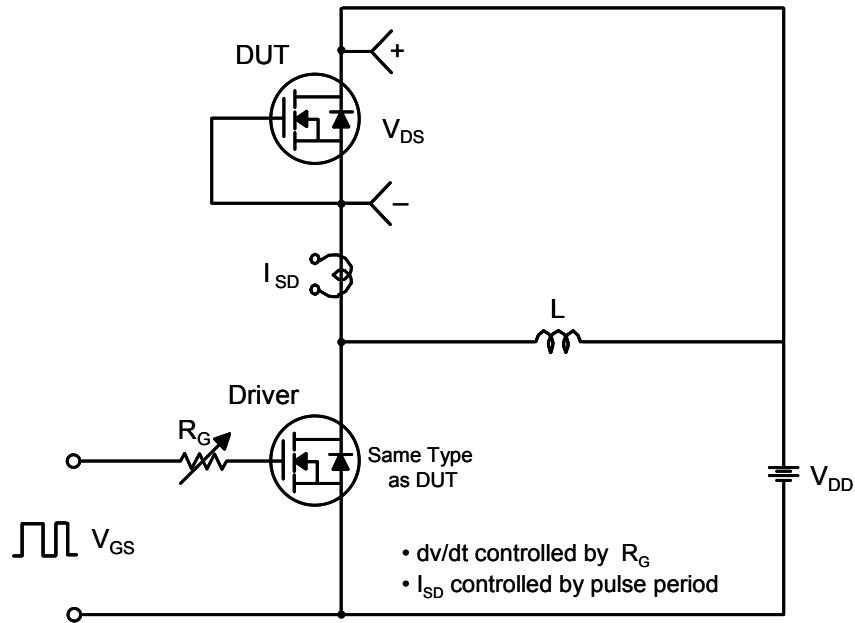

Figure 14. Peak Diode Recovery dv/dt Test Circuit & Waveforms



Mechanical Dimensions

TO-263 2L (D²PAK)



Figure 15. 2LD, TO263, Surface Mount

Package drawings are provided as a service to customers considering ON Semiconductor components. Drawings may change in any manner without notice. Please note the revision and/or date on the drawing and contact a ON Semiconductor representative to verify or obtain the most recent revision. Package specifications do not expand the terms of ON Semiconductor's worldwide terms and conditions, specifically the warranty therein, which covers ON Semiconductor products.

Dimension in Millimeters

ON Semiconductor and  are trademarks of Semiconductor Components Industries, LLC dba ON Semiconductor or its subsidiaries in the United States and/or other countries. ON Semiconductor owns the rights to a number of patents, trademarks, copyrights, trade secrets, and other intellectual property. A listing of ON Semiconductor's product/patent coverage may be accessed at www.onsemi.com/site/pdf/Patent-Marking.pdf. ON Semiconductor reserves the right to make changes without further notice to any products herein. ON Semiconductor makes no warranty, representation or guarantee regarding the suitability of its products for any particular purpose, nor does ON Semiconductor assume any liability arising out of the application or use of any product or circuit, and specifically disclaims any and all liability, including without limitation special, consequential or incidental damages. Buyer is responsible for its products and applications using ON Semiconductor products, including compliance with all laws, regulations and safety requirements or standards, regardless of any support or applications information provided by ON Semiconductor. "Typical" parameters which may be provided in ON Semiconductor data sheets and/or specifications can and do vary in different applications and actual performance may vary over time. All operating parameters, including "Typicals" must be validated for each customer application by customer's technical experts. ON Semiconductor does not convey any license under its patent rights nor the rights of others. ON Semiconductor products are not designed, intended, or authorized for use as a critical component in life support systems or any FDA Class 3 medical devices or medical devices with a same or similar classification in a foreign jurisdiction or any devices intended for implantation in the human body. Should Buyer purchase or use ON Semiconductor products for any such unintended or unauthorized application, Buyer shall indemnify and hold ON Semiconductor and its officers, employees, subsidiaries, affiliates, and distributors harmless against all claims, costs, damages, and expenses, and reasonable attorney fees arising out of, directly or indirectly, any claim of personal injury or death associated with such unintended or unauthorized use, even if such claim alleges that ON Semiconductor was negligent regarding the design or manufacture of the part. ON Semiconductor is an Equal Opportunity/Affirmative Action Employer. This literature is subject to all applicable copyright laws and is not for resale in any manner.

PUBLICATION ORDERING INFORMATION

LITERATURE FULFILLMENT:

Literature Distribution Center for ON Semiconductor
19521 E. 32nd Pkwy, Aurora, Colorado 80011 USA
Phone: 303-675-2175 or 800-344-3860 Toll Free USA/Canada
Fax: 303-675-2176 or 800-344-3867 Toll Free USA/Canada
Email: orderlit@onsemi.com

N. American Technical Support: 800-282-9855 Toll Free
USA/Canada
Europe, Middle East and Africa Technical Support:
Phone: 421 33 790 2910
Japan Customer Focus Center
Phone: 81-3-5817-1050

ON Semiconductor Website: www.onsemi.com
Order Literature: <http://www.onsemi.com/orderlit>
For additional information, please contact your local
Sales Representative

X-ON Electronics

Largest Supplier of Electrical and Electronic Components

Click to view similar products for [MOSFET](#) category:

Click to view products by [ON Semiconductor](#) manufacturer:

Other Similar products are found below :

[614233C](#) [648584F](#) [IRFD120](#) [JANTX2N5237](#) [FCA20N60_F109](#) [FDZ595PZ](#) [2SK2545\(Q,T\)](#) [405094E](#) [423220D](#) [TPCC8103,L1Q\(CM](#)
[MIC4420CM-TR](#) [VN1206L](#) [SBVS138LT1G](#) [614234A](#) [715780A](#) [NTNS3166NZT5G](#) [SSM6J414TU,LF\(T](#) [751625C](#) [BUK954R8-60E](#)
[NTE6400](#) [SQJ402EP-T1-GE3](#) [2SK2614\(TE16L1,Q\)](#) [2N7002KW-FAI](#) [DMN1017UCP3-7](#) [EFC2J004NUZTDG](#) [ECH8691-TL-W](#)
[FCAB21350L1](#) [P85W28HP2F-7071](#) [DMN1053UCP4-7](#) [NTE221](#) [NTE222](#) [NTE2384](#) [NTE2903](#) [NTE2941](#) [NTE2945](#) [NTE2946](#) [NTE2960](#)
[NTE2967](#) [NTE2969](#) [NTE2976](#) [NTE455](#) [NTE6400A](#) [NTE2910](#) [NTE2916](#) [NTE2956](#) [NTE2911](#) [DMN2080UCB4-7](#) [TK10A80W,S4X\(S](#)
[SSM6P69NU,LF](#) [DMP22D4UFO-7B](#)