



Is Now Part of



ON Semiconductor®

To learn more about ON Semiconductor, please visit our website at
www.onsemi.com

Please note: As part of the Fairchild Semiconductor integration, some of the Fairchild orderable part numbers will need to change in order to meet ON Semiconductor's system requirements. Since the ON Semiconductor product management systems do not have the ability to manage part nomenclature that utilizes an underscore (_), the underscore (_) in the Fairchild part numbers will be changed to a dash (-). This document may contain device numbers with an underscore (_). Please check the ON Semiconductor website to verify the updated device numbers. The most current and up-to-date ordering information can be found at www.onsemi.com. Please email any questions regarding the system integration to Fairchild_questions@onsemi.com.

ON Semiconductor and the ON Semiconductor logo are trademarks of Semiconductor Components Industries, LLC dba ON Semiconductor or its subsidiaries in the United States and/or other countries. ON Semiconductor owns the rights to a number of patents, trademarks, copyrights, trade secrets, and other intellectual property. A listing of ON Semiconductor's product/patent coverage may be accessed at www.onsemi.com/site/pdf/Patent-Marking.pdf. ON Semiconductor reserves the right to make changes without further notice to any products herein. ON Semiconductor makes no warranty, representation or guarantee regarding the suitability of its products for any particular purpose, nor does ON Semiconductor assume any liability arising out of the application or use of any product or circuit, and specifically disclaims any and all liability, including without limitation special, consequential or incidental damages. Buyer is responsible for its products and applications using ON Semiconductor products, including compliance with all laws, regulations and safety requirements or standards, regardless of any support or applications information provided by ON Semiconductor. "Typical" parameters which may be provided in ON Semiconductor data sheets and/or specifications can and do vary in different applications and actual performance may vary over time. All operating parameters, including "Typicals" must be validated for each customer application by customer's technical experts. ON Semiconductor does not convey any license under its patent rights nor the rights of others. ON Semiconductor products are not designed, intended, or authorized for use as a critical component in life support systems or any FDA Class 3 medical devices or medical devices with a same or similar classification in a foreign jurisdiction or any devices intended for implantation in the human body. Should Buyer purchase or use ON Semiconductor products for any such unintended or unauthorized application, Buyer shall indemnify and hold ON Semiconductor and its officers, employees, subsidiaries, affiliates, and distributors harmless against all claims, costs, damages, and expenses, and reasonable attorney fees arising out of, directly or indirectly, any claim of personal injury or death associated with such unintended or unauthorized use, even if such claim alleges that ON Semiconductor was negligent regarding the design or manufacture of the part. ON Semiconductor is an Equal Opportunity/Affirmative Action Employer. This literature is subject to all applicable copyright laws and is not for resale in any manner.

FDD6N50F

N-Channel UniFET™ FRFET® MOSFET

500 V, 5.5 A, 1.15 Ω

Features

- $R_{DS(on)} = 950\text{ m}\Omega$ (Typ.) @ $V_{GS} = 10\text{ V}$, $I_D = 2.75\text{ A}$
- Low Gate Charge (Typ. 15nC)
- Low C_{rss} (Typ. 6.3pF)
- 100% Avalanche Tested
- Improved dv/dt Capability
- RoHS Compliant

Applications

- LCD/LED/PDP TV
- Lighting
- Uninterruptible Power Supply
- AC-DC Power Supply

Description

UniFET™ MOSFET is Fairchild Semiconductor's high voltage MOSFET family based on planar stripe and DMOS technology. This MOSFET is tailored to reduce on-state resistance, and to provide better switching performance and higher avalanche energy strength. The body diode's reverse recovery performance of UniFET FRFET® MOSFET has been enhanced by lifetime control. Its trr is less than 100nsec and the reverse dv/dt immunity is 15V/ns while normal planar MOSFETs have over 200nsec and 4.5V/nsec respectively. Therefore, it can remove additional component and improve system reliability in certain applications in which the performance of MOSFET's body diode is significant. This device family is suitable for switching power converter applications such as power factor correction (PFC), flat panel display (FPD) TV power, ATX and electronic lamp ballasts.

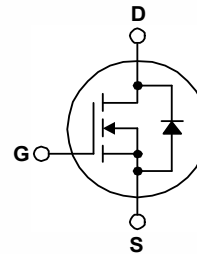
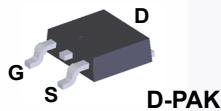

MOSFET Maximum Ratings $T_C = 25^\circ\text{C}$ unless otherwise noted.

Symbol	Parameter	FDD6N50F	Unit
V_{DSS}	Drain to Source Voltage	500	V
V_{GSS}	Gate to Source Voltage	±30	V
I_D	Drain Current	- Continuous ($T_C = 25^\circ\text{C}$)	5.5
		- Continuous ($T_C = 100^\circ\text{C}$)	2.4
I_{DM}	Drain Current	- Pulsed (Note 1)	22
E_{AS}	Single Pulsed Avalanche Energy (Note 2)	270	mJ
I_{AR}	Avalanche Current (Note 1)	5.5	A
E_{AR}	Repetitive Avalanche Energy (Note 1)	8.9	mJ
dv/dt	Peak Diode Recovery dv/dt (Note 3)	20	V/ns
P_D	Power Dissipation	($T_C = 25^\circ\text{C}$)	89
		- Derate Above 25°C	0.71
T_J, T_{STG}	Operating and Storage Temperature Range	-55 to +150	$^\circ\text{C}$
T_L	Maximum Lead Temperature for Soldering, 1/8" from Case for 5 Seconds	300	$^\circ\text{C}$

Thermal Characteristics

Symbol	Parameter	FDD6N50F	Unit
$R_{\theta JC}$	Thermal Resistance, Junction to Case, Max.	1.4	$^\circ\text{C}/\text{W}$
$R_{\theta JA}$	Thermal Resistance, Junction to Ambient, Max.	83	

Package Marking and Ordering Information

Part Number	Top Mark	Package	Packing Method	Reel Size	Tape Width	Quantity
FDD6N50FTM	FDD6N50F	DPAK	Tape and Reel	330 mm	16 mm	2500 units

Electrical Characteristics $T_C = 25^\circ\text{C}$ unless otherwise noted.

Symbol	Parameter	Test Conditions	Min.	Typ.	Max.	Unit
--------	-----------	-----------------	------	------	------	------

Off Characteristics

BV_{DSS}	Drain to Source Breakdown Voltage	$I_D = 250 \mu\text{A}, V_{GS} = 0 \text{V}, T_J = 25^\circ\text{C}$	500	-	-	V
$\Delta BV_{DSS} / \Delta T_J$	Breakdown Voltage Temperature Coefficient	$I_D = 250 \mu\text{A}, \text{Referenced to } 25^\circ\text{C}$	-	0.15	-	$\text{V}/^\circ\text{C}$
I_{DSS}	Zero Gate Voltage Drain Current	$V_{DS} = 500 \text{V}, V_{GS} = 0 \text{V}$ $V_{DS} = 400 \text{V}, T_C = 125^\circ\text{C}$	-	-	10 100	μA
I_{GSS}	Gate to Body Leakage Current	$V_{GS} = \pm 30 \text{V}, V_{DS} = 0 \text{V}$	-	-	± 100	nA

On Characteristics

$V_{GS(th)}$	Gate Threshold Voltage	$V_{GS} = V_{DS}, I_D = 250 \mu\text{A}$	3.0	-	5.0	V
$R_{DS(on)}$	Static Drain to Source On Resistance	$V_{GS} = 10 \text{V}, I_D = 2.75 \text{A}$	-	0.95	1.15	Ω
g_{FS}	Forward Transconductance	$V_{DS} = 40 \text{V}, I_D = 2.75 \text{A}$	-	4.3	-	S

Dynamic Characteristics

C_{iss}	Input Capacitance	$V_{DS} = 25 \text{V}, V_{GS} = 0 \text{V},$ $f = 1 \text{MHz}$	-	720	960	pF
C_{oss}	Output Capacitance		-	85	115	pF
C_{rss}	Reverse Transfer Capacitance		-	6.3	9.5	pF
$Q_{g(tot)}$	Total Gate Charge at 10V	$V_{DS} = 400 \text{V}, I_D = 6 \text{A},$ $V_{GS} = 10 \text{V}$	-	15	19.8	nC
Q_{gs}	Gate to Source Gate Charge		-	4.4	-	nC
Q_{gd}	Gate to Drain "Miller" Charge		(Note 4)	-	6.1	-

Switching Characteristics

$t_{d(on)}$	Turn-On Delay Time	$V_{DD} = 250 \text{V}, I_D = 6 \text{A},$ $V_{GS} = 10 \text{V}, R_G = 25 \Omega$	-	17	44	ns
t_r	Turn-On Rise Time		-	28.3	66.6	ns
$t_{d(off)}$	Turn-Off Delay Time		-	33.4	76.7	ns
t_f	Turn-Off Fall Time		(Note 4)	-	20.5	51

Drain-Source Diode Characteristics

I_S	Maximum Continuous Drain to Source Diode Forward Current	-	-	5.5	A	
I_{SM}	Maximum Pulsed Drain to Source Diode Forward Current	-	-	22	A	
V_{SD}	Drain to Source Diode Forward Voltage	$V_{GS} = 0 \text{V}, I_{SD} = 5.5 \text{A}$	-	-	1.5	V
t_{rr}	Reverse Recovery Time	$V_{GS} = 0 \text{V}, I_{SD} = 5.5 \text{A},$ $di_F/dt = 100 \text{A}/\mu\text{s}$	-	85	-	ns
Q_{rr}	Reverse Recovery Charge		-	0.15	-	μC

Notes:

- 1: Repetitive rating: pulse-width limited by maximum junction temperature.
- 2: $L = 16 \text{mH}, I_{AS} = 5.5 \text{A}, V_{DD} = 50 \text{V}, R_G = 25 \Omega$, starting $T_J = 25^\circ\text{C}$.
- 3: $I_{SD} \leq 5.5 \text{A}, di/dt \leq 200 \text{A}/\mu\text{s}, V_{DD} \leq BV_{DSS}$, starting $T_J = 25^\circ\text{C}$.
- 4: Essentially independent of operating temperature typical characteristics.

Typical Performance Characteristics

Figure 1. On-Region Characteristics

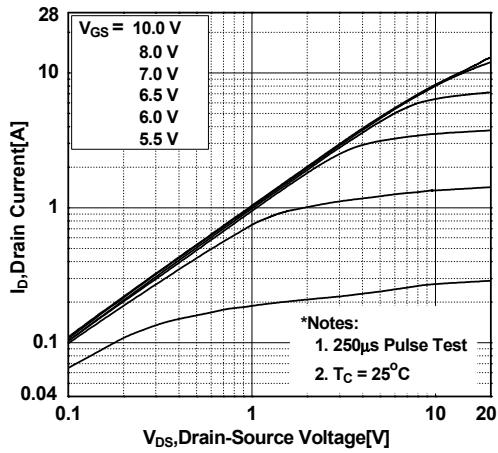

Figure 2. Transfer Characteristics

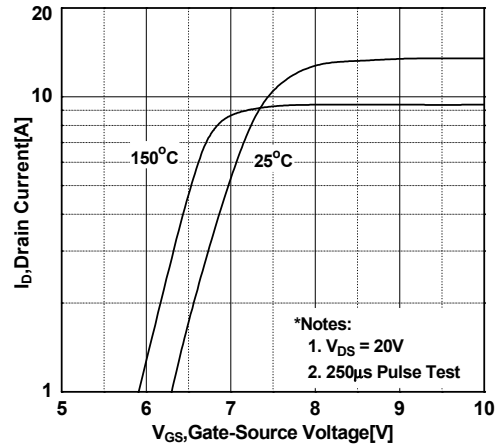

Figure 3. On-Resistance Variation vs. Drain Current and Gate Voltage

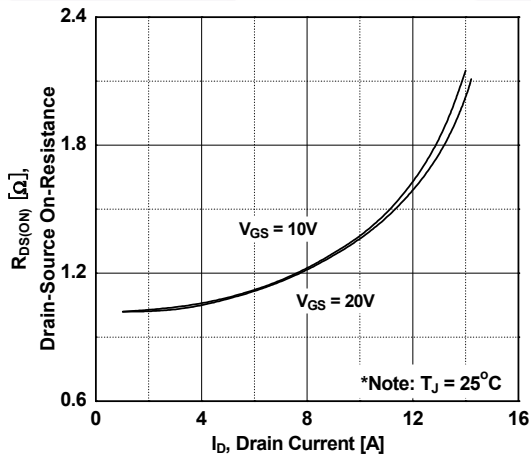

Figure 4. Body Diode Forward Voltage Variation vs. Source Current and Temperature

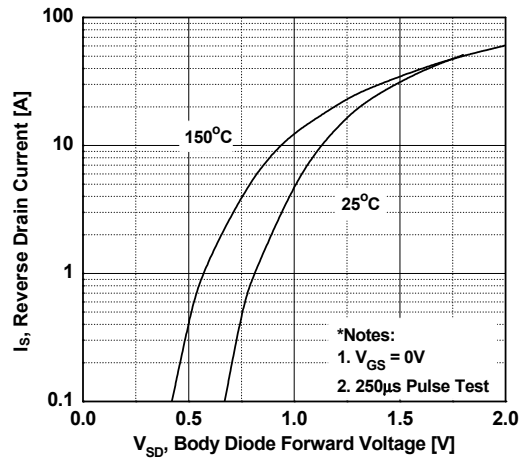

Figure 5. Capacitance Characteristics

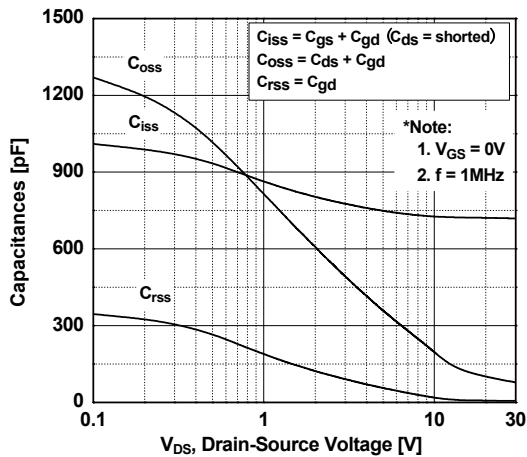
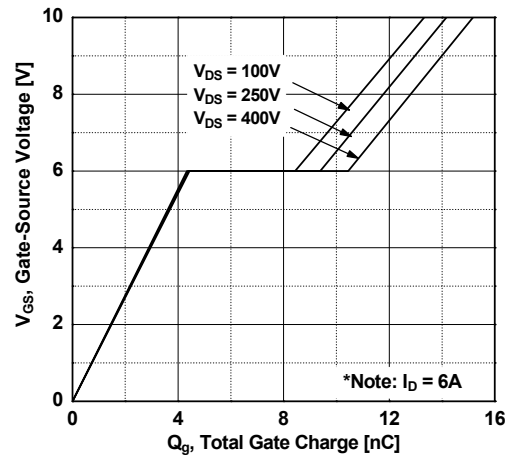

Figure 6. Gate Charge Characteristics



Typical Performance Characteristics (Continued)

Figure 7. Breakdown Voltage Variation vs. Temperature

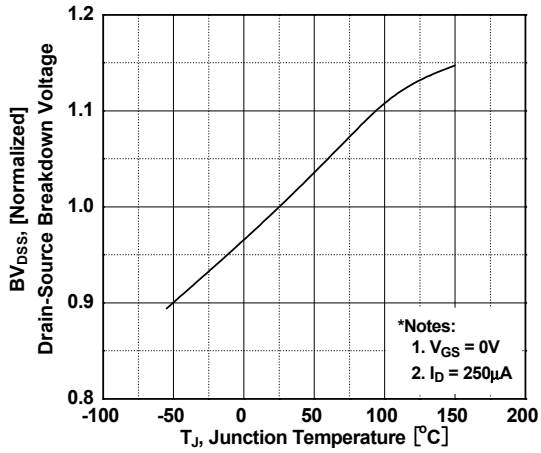

Figure 8. Maximum Safe Operating Area

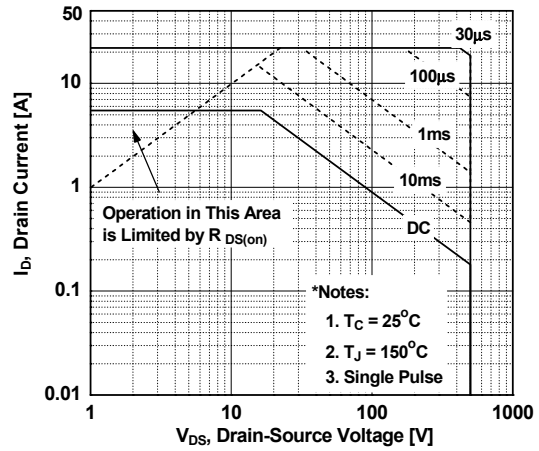

Figure 9. Maximum Drain Current vs. Case Temperature

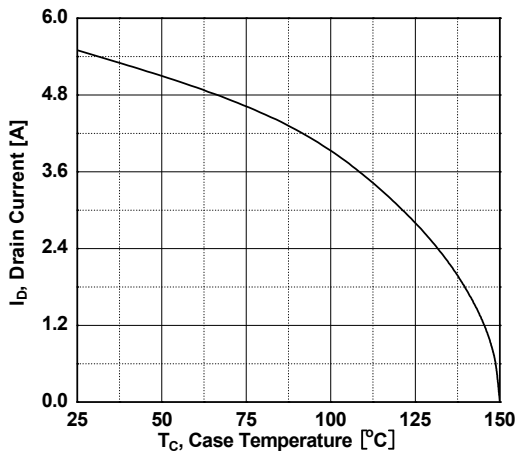

Figure 10. Transient Thermal Response Curve

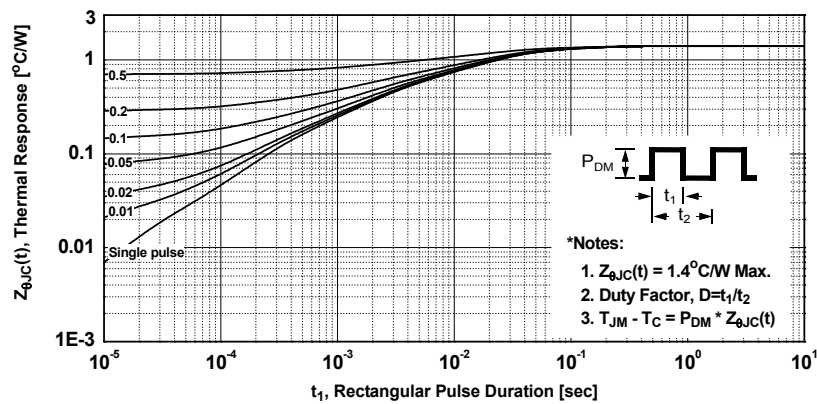



Figure 11. Gate Charge Test Circuit & Waveform



Figure 12. Resistive Switching Test Circuit & Waveforms



Figure 13. Unclamped Inductive Switching Test Circuit & Waveforms



Figure 14. Peak Diode Recovery dv/dt Test Circuit & Waveforms

Mechanical Dimensions



- NOTES: UNLESS OTHERWISE SPECIFIED
- A) THIS PACKAGE CONFORMS TO JEDEC, TO-252, ISSUE C, VARIATION AA.
 - B) ALL DIMENSIONS ARE IN MILLIMETERS.
 - C) DIMENSIONING AND TOLERANCING PER ASME Y14.5M-1994.
 - D) HEAT SINK TOP EDGE COULD BE IN CHAMFERED CORNERS OR EDGE PROTRUSION.
 - E) PRESENCE OF TRIMMED CENTER LEAD IS OPTIONAL.
 - F) DIMENSIONS ARE EXCLUSIVE OF BURRS, MOLD FLASH AND TIE BAR EXTRUSIONS.
 - G) LAND PATTERN RECOMMENDATION IS BASED ON IPC351A STD TO220P1003X238-3N.
 - H) DRAWING NUMBER AND REVISION: MKT-T0252A03REV8

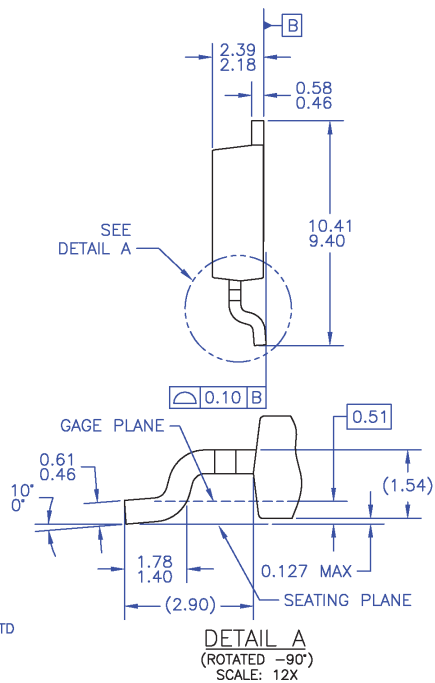

Figure 15. TO252 (D-PAK), Molded, 3-Lead, Option AA&AB

Package drawings are provided as a service to customers considering Fairchild components. Drawings may change in any manner without notice. Please note the revision and/or date on the drawing and contact a Fairchild Semiconductor representative to verify or obtain the most recent revision. Package specifications do not expand the terms of Fairchild's worldwide terms and conditions, specifically the warranty therein, which covers Fairchild products.

Always visit Fairchild Semiconductor's online packaging area for the most recent package drawings:

http://www.fairchildsemi.com/package/packageDetails.html?id=PN_TT252-003

ON Semiconductor and  are trademarks of Semiconductor Components Industries, LLC dba ON Semiconductor or its subsidiaries in the United States and/or other countries. ON Semiconductor owns the rights to a number of patents, trademarks, copyrights, trade secrets, and other intellectual property. A listing of ON Semiconductor's product/patent coverage may be accessed at www.onsemi.com/site/pdf/Patent-Marking.pdf. ON Semiconductor reserves the right to make changes without further notice to any products herein. ON Semiconductor makes no warranty, representation or guarantee regarding the suitability of its products for any particular purpose, nor does ON Semiconductor assume any liability arising out of the application or use of any product or circuit, and specifically disclaims any and all liability, including without limitation special, consequential or incidental damages. Buyer is responsible for its products and applications using ON Semiconductor products, including compliance with all laws, regulations and safety requirements or standards, regardless of any support or applications information provided by ON Semiconductor. "Typical" parameters which may be provided in ON Semiconductor data sheets and/or specifications can and do vary in different applications and actual performance may vary over time. All operating parameters, including "Typicals" must be validated for each customer application by customer's technical experts. ON Semiconductor does not convey any license under its patent rights nor the rights of others. ON Semiconductor products are not designed, intended, or authorized for use as a critical component in life support systems or any FDA Class 3 medical devices or medical devices with a same or similar classification in a foreign jurisdiction or any devices intended for implantation in the human body. Should Buyer purchase or use ON Semiconductor products for any such unintended or unauthorized application, Buyer shall indemnify and hold ON Semiconductor and its officers, employees, subsidiaries, affiliates, and distributors harmless against all claims, costs, damages, and expenses, and reasonable attorney fees arising out of, directly or indirectly, any claim of personal injury or death associated with such unintended or unauthorized use, even if such claim alleges that ON Semiconductor was negligent regarding the design or manufacture of the part. ON Semiconductor is an Equal Opportunity/Affirmative Action Employer. This literature is subject to all applicable copyright laws and is not for resale in any manner.

PUBLICATION ORDERING INFORMATION

LITERATURE FULFILLMENT:

Literature Distribution Center for ON Semiconductor
19521 E. 32nd Pkwy, Aurora, Colorado 80011 USA
Phone: 303-675-2175 or 800-344-3860 Toll Free USA/Canada
Fax: 303-675-2176 or 800-344-3867 Toll Free USA/Canada
Email: orderlit@onsemi.com

N. American Technical Support: 800-282-9855 Toll Free
USA/Canada
Europe, Middle East and Africa Technical Support:
Phone: 421 33 790 2910
Japan Customer Focus Center
Phone: 81-3-5817-1050

ON Semiconductor Website: www.onsemi.com
Order Literature: <http://www.onsemi.com/orderlit>
For additional information, please contact your local
Sales Representative

X-ON Electronics

Largest Supplier of Electrical and Electronic Components

Click to view similar products for [MOSFET](#) category:

Click to view products by [ON Semiconductor](#) manufacturer:

Other Similar products are found below :

[614233C](#) [648584F](#) [IRFD120](#) [JANTX2N5237](#) [FCA20N60_F109](#) [FDZ595PZ](#) [2SK2545\(Q,T\)](#) [405094E](#) [423220D](#) [TPCC8103,L1Q\(CM](#)
[MIC4420CM-TR](#) [VN1206L](#) [SBVS138LT1G](#) [614234A](#) [715780A](#) [NTNS3166NZT5G](#) [SSM6J414TU,LF\(T](#) [751625C](#) [BUK954R8-60E](#)
[NTE6400](#) [SQJ402EP-T1-GE3](#) [2SK2614\(TE16L1,Q\)](#) [2N7002KW-FAI](#) [DMN1017UCP3-7](#) [EFC2J004NUZTDG](#) [ECH8691-TL-W](#)
[FCAB21350L1](#) [P85W28HP2F-7071](#) [DMN1053UCP4-7](#) [NTE221](#) [NTE222](#) [NTE2384](#) [NTE2903](#) [NTE2941](#) [NTE2945](#) [NTE2946](#) [NTE2960](#)
[NTE2967](#) [NTE2969](#) [NTE2976](#) [NTE455](#) [NTE6400A](#) [NTE2910](#) [NTE2916](#) [NTE2956](#) [NTE2911](#) [DMN2080UCB4-7](#) [TK10A80W,S4X\(S](#)
[SSM6P69NU,LF](#) [DMP22D4UFO-7B](#)