

# ON Semiconductor

## Is Now

# onsemi™

To learn more about onsemi™, please visit our website at  
[www.onsemi.com](http://www.onsemi.com)

---

**onsemi** and **onsemi** and other names, marks, and brands are registered and/or common law trademarks of Semiconductor Components Industries, LLC dba "**onsemi**" or its affiliates and/or subsidiaries in the United States and/or other countries. **onsemi** owns the rights to a number of patents, trademarks, copyrights, trade secrets, and other intellectual property. A listing of **onsemi** product/patent coverage may be accessed at [www.onsemi.com/site/pdf/Patent-Marking.pdf](http://www.onsemi.com/site/pdf/Patent-Marking.pdf). **onsemi** reserves the right to make changes at any time to any products or information herein, without notice. The information herein is provided "as-is" and **onsemi** makes no warranty, representation or guarantee regarding the accuracy of the information, product features, availability, functionality, or suitability of its products for any particular purpose, nor does **onsemi** assume any liability arising out of the application or use of any product or circuit, and specifically disclaims any and all liability, including without limitation special, consequential or incidental damages. Buyer is responsible for its products and applications using **onsemi** products, including compliance with all laws, regulations and safety requirements or standards, regardless of any support or applications information provided by **onsemi**. "Typical" parameters which may be provided in **onsemi** data sheets and/or specifications can and do vary in different applications and actual performance may vary over time. All operating parameters, including "Typicals" must be validated for each customer application by customer's technical experts. **onsemi** does not convey any license under any of its intellectual property rights nor the rights of others. **onsemi** products are not designed, intended, or authorized for use as a critical component in life support systems or any FDA Class 3 medical devices or medical devices with a same or similar classification in a foreign jurisdiction or any devices intended for implantation in the human body. Should Buyer purchase or use **onsemi** products for any such unintended or unauthorized application, Buyer shall indemnify and hold **onsemi** and its officers, employees, subsidiaries, affiliates, and distributors harmless against all claims, costs, damages, and expenses, and reasonable attorney fees arising out of, directly or indirectly, any claim of personal injury or death associated with such unintended or unauthorized use, even if such claim alleges that **onsemi** was negligent regarding the design or manufacture of the part. **onsemi** is an Equal Opportunity/Affirmative Action Employer. This literature is subject to all applicable copyright laws and is not for resale in any manner. Other names and brands may be claimed as the property of others.



ON Semiconductor®

## FDG6323L Integrated Load Switch

### General Description

This device is particularly suited for compact power management in portable electronic equipment where 2.5V to 8V input and 0.6A output current capability are needed. This load switch integrates a small N-Channel power MOSFET (Q1) which drives a large P-Channel power MOSFET (Q2) in one tiny SC70-6 package.

### Features

- $V_{\text{DROP}}=0.2\text{V}$  @  $V_{\text{IN}}=5\text{V}$ ,  $I_{\text{L}}=0.36\text{A}$ .  $R_{\text{(ON)}} = 0.55\Omega$   
 $V_{\text{DROP}}=0.2\text{V}$  @  $V_{\text{IN}}=2.5\text{V}$ ,  $I_{\text{L}}=0.27\text{A}$ .  $R_{\text{(ON)}} = 0.75\Omega$ .
- Very small package outline SC70-6.
- Control MOSFET (Q1) includes Zener protection for ESD ruggedness (>6KV Human Body Model).
- High density cell design for extremely low on-resistance.
- Compact industry standard SC70-6 surface mount package.

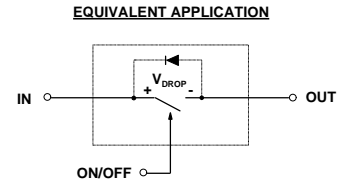
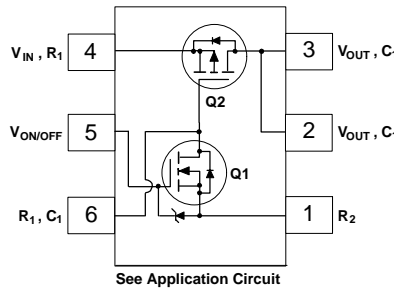
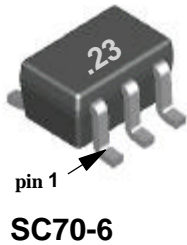
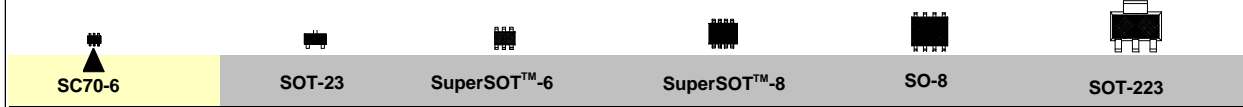

### Absolute Maximum Ratings $T_A = 25^\circ\text{C}$ unless otherwise noted

Symbol	Parameter	FDG6323L	Units
$V_{\text{IN}}$	Input Voltage Range	2.5 - 8	V
$V_{\text{ON/OFF}}$	On/Off Voltage Range	1.5 - 8	V
$I_{\text{L}}$	Load Current - Continuous (Note 1) - Pulsed (Note 1 & 3)	0.6	A
		1.8	
$P_{\text{D}}$	Maximum Power Dissipation (Note 2)	0.3	W
$T_{\text{J}}, T_{\text{STG}}$	Operating and Storage Temperature Range	-55 to 150	$^\circ\text{C}$
ESD	Electrostatic Discharge Rating MIL-STD-883D Human Body Model (100pf/1500Ohm)	6	kV

### THERMAL CHARACTERISTICS

$R_{\theta\text{JA}}$	Thermal Resistance, Junction-to-Ambient (Note 2)	415	$^\circ\text{C/W}$
-----------------------	--------------------------------------------------	-----	--------------------

## Electrical Characteristics (T<sub>A</sub> = 25°C unless otherwise noted)

Symbol	Parameter	Conditions	Min	Typ	Max	Units
<b>OFF CHARACTERISTICS</b>						
I <sub>FL</sub>	Forward Leakage Current	V <sub>IN</sub> = 8 V, V <sub>ON/OFF</sub> = 0 V			1	μA
<b>ON CHARACTERISTICS</b> (Note 3)						
V <sub>DROP</sub>	Conduction Voltage Drop	V <sub>IN</sub> = 5 V, V <sub>ON/OFF</sub> = 3.3 V, I <sub>L</sub> = 0.36 A		0.14	0.2	V
		V <sub>IN</sub> = 2.5 V, V <sub>ON/OFF</sub> = 3.3 V, I <sub>L</sub> = 0.27 A		0.15	0.2	
R <sub>(ON)</sub>	Q <sub>2</sub> - Static On-Resistance	V <sub>GS</sub> = -5 V, I <sub>D</sub> = -0.6 A		0.41	0.55	Ω
		V <sub>GS</sub> = -2.5 V, I <sub>D</sub> = -0.5 A		0.58	0.75	
I <sub>L</sub>	Load Current	V <sub>DROP</sub> = 0.2 V, V <sub>IN</sub> = 5 V, V <sub>ON/OFF</sub> = 3.3 V	0.36			A
		V <sub>DROP</sub> = 0.2 V, V <sub>IN</sub> = 2.5 V, V <sub>ON/OFF</sub> = 3.3 V	0.27			

### Notes:

- Range of V<sub>in</sub> can be up to 8V, but R<sub>1</sub> and R<sub>2</sub> must be scaled such that V<sub>GS</sub> of Q2 does not exceed -8V.
- R<sub>th(j-c)</sub> is the sum of the junction-to-case and case-to-ambient thermal resistance where the case thermal reference is defined as the solder mounting surface of the drain pins. R<sub>th(j-c)</sub> is guaranteed by design while R<sub>th(c-a)</sub> is determined by the user's board design.
- Pulse Test: Pulse Width ≤ 300μs, Duty Cycle ≤ 2.0%

## FDG6323L Load Switch Application

### APPLICATION CIRCUIT

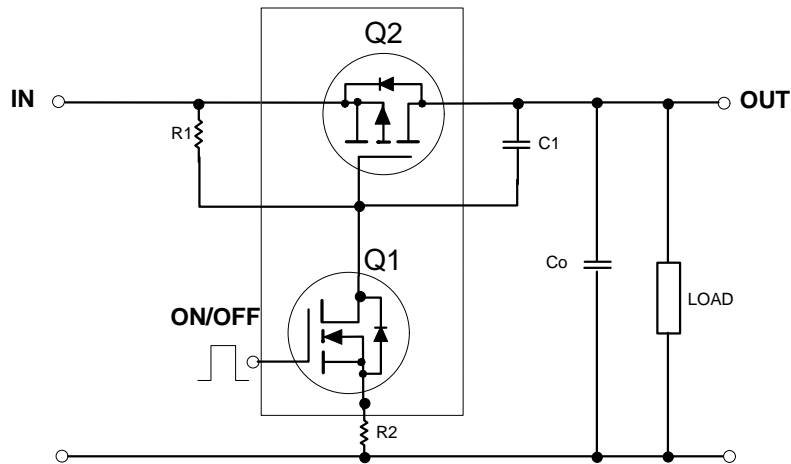

### External Component Recommendation

R1 is required to turn Q2 off.  
R2 is optional for Slew Rate Control.

For Co ≤ 1μF applications:

First select R2, 100 - 1KΩ, for Slew Rate control.

Then select R1 such that R1/R2 ratio maintains between 10 - 100.

**Typical Electrical Characteristics** ( $T_A = 25\text{ }^\circ\text{C}$  unless otherwise noted )

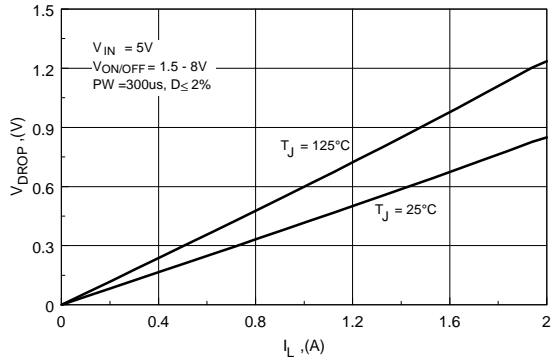

**Figure 1. Conduction Voltage Drop Variation with Load Current.**

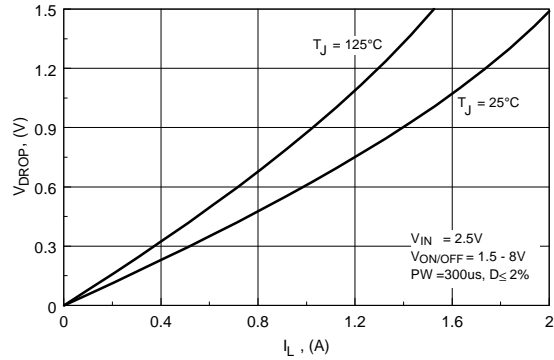

**Figure 2. Conduction Voltage Drop Variation with Load Current.**

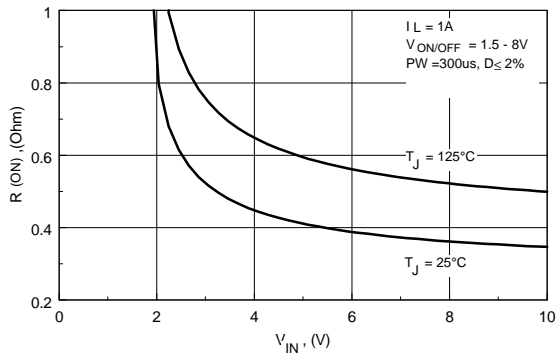

**Figure 3. On-Resistance Variation with Input Voltage.**

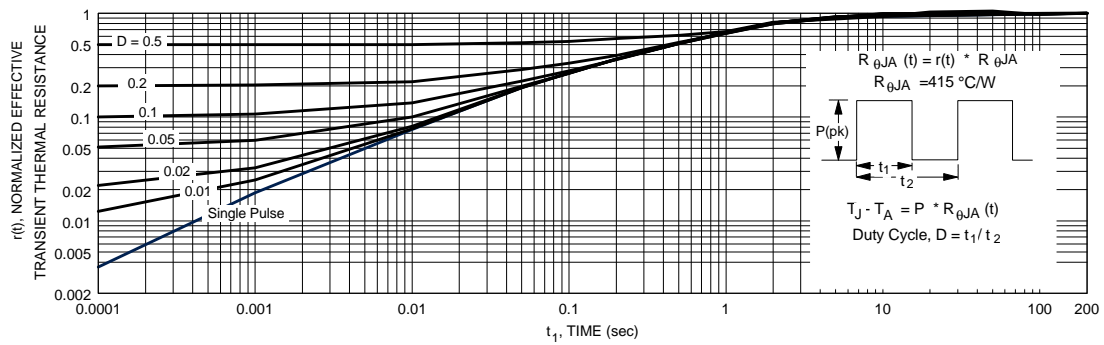

**Figure 4. Transient Thermal Response Curve.**

Thermal characterization performed using the conditions described in Note 2.  
 Transient thermal response will change depending on the circuit board design.

ON Semiconductor and  are trademarks of Semiconductor Components Industries, LLC dba ON Semiconductor or its subsidiaries in the United States and/or other countries. ON Semiconductor owns the rights to a number of patents, trademarks, copyrights, trade secrets, and other intellectual property. A listing of ON Semiconductor's product/patent coverage may be accessed at [www.onsemi.com/site/pdf/Patent-Marking.pdf](http://www.onsemi.com/site/pdf/Patent-Marking.pdf). ON Semiconductor reserves the right to make changes without further notice to any products herein. ON Semiconductor makes no warranty, representation or guarantee regarding the suitability of its products for any particular purpose, nor does ON Semiconductor assume any liability arising out of the application or use of any product or circuit, and specifically disclaims any and all liability, including without limitation special, consequential or incidental damages. Buyer is responsible for its products and applications using ON Semiconductor products, including compliance with all laws, regulations and safety requirements or standards, regardless of any support or applications information provided by ON Semiconductor. "Typical" parameters which may be provided in ON Semiconductor data sheets and/or specifications can and do vary in different applications and actual performance may vary over time. All operating parameters, including "Typicals" must be validated for each customer application by customer's technical experts. ON Semiconductor does not convey any license under its patent rights nor the rights of others. ON Semiconductor products are not designed, intended, or authorized for use as a critical component in life support systems or any FDA Class 3 medical devices or medical devices with a same or similar classification in a foreign jurisdiction or any devices intended for implantation in the human body. Should Buyer purchase or use ON Semiconductor products for any such unintended or unauthorized application, Buyer shall indemnify and hold ON Semiconductor and its officers, employees, subsidiaries, affiliates, and distributors harmless against all claims, costs, damages, and expenses, and reasonable attorney fees arising out of, directly or indirectly, any claim of personal injury or death associated with such unintended or unauthorized use, even if such claim alleges that ON Semiconductor was negligent regarding the design or manufacture of the part. ON Semiconductor is an Equal Opportunity/Affirmative Action Employer. This literature is subject to all applicable copyright laws and is not for resale in any manner.

## PUBLICATION ORDERING INFORMATION

### LITERATURE FULFILLMENT:

Literature Distribution Center for ON Semiconductor  
19521 E. 32nd Pkwy, Aurora, Colorado 80011 USA  
**Phone:** 303-675-2175 or 800-344-3860 Toll Free USA/Canada  
**Fax:** 303-675-2176 or 800-344-3867 Toll Free USA/Canada  
**Email:** [orderlit@onsemi.com](mailto:orderlit@onsemi.com)

**N. American Technical Support:** 800-282-9855 Toll Free  
USA/Canada  
**Europe, Middle East and Africa Technical Support:**  
Phone: 421 33 790 2910  
**Japan Customer Focus Center**  
Phone: 81-3-5817-1050

**ON Semiconductor Website:** [www.onsemi.com](http://www.onsemi.com)  
**Order Literature:** <http://www.onsemi.com/orderlit>  
For additional information, please contact your local  
Sales Representative

## X-ON Electronics

Largest Supplier of Electrical and Electronic Components

*Click to view similar products for* [Power Switch ICs - Power Distribution](#) *category:*

*Click to view products by* [ON Semiconductor](#) *manufacturer:*

Other Similar products are found below :

[TCK111G,LF\(S\)](#) [FPF1018](#) [DS1222](#) [TCK2065G,LF](#) [SZNCP3712ASNT3G](#) [MIC2033-05BYMT-T5](#) [MIC2033-12AYMT-T5](#) [MIC2033-05BYM6-T5](#) [SLG5NT1437VTR](#) [SZNCP3712ASNT1G](#) [DML1008LDS-7](#) [KTS1670EDA-TR](#) [KTS1640QGDV-TR](#) [KTS1641QGDV-TR](#) [NCV459MNWTBG](#) [FPF2260ATMX](#) [U6513A](#) [MIC2012YM-TR](#) [NCP45780IMN24RTWG](#) [AP22953CW12-7](#) [MAX14919AUP+T](#) [MAX14919ATP+](#) [KTS1697AEOAB-TR](#) [TCK207AN,LF](#) [BD2227G-LBTR](#) [TCK126BG,LF](#) [XC8111AA010R-G](#) [MPQ5072GG-AEC1-P](#) [TCK128BG,LF](#) [XC8110AA018R-G](#) [XC8110AA010R-G](#) [XC8111AA018R-G](#) [MC33882PEP](#) [TPS2104DBVR](#) [MIC2098-1YMT-TR](#) [MIC94062YMT TR](#) [MP6231DN-LF](#) [MIC2015-1.2YM6 TR](#) [MIC2075-2YM](#) [MIC94068YML-TR](#) [SIP32461DB-T2-GE1](#) [NCP335FCT2G](#) [TCK105G,LF\(S\)](#) [AP2411S-13](#) [AP2151DSG-13](#) [AP2172MPG-13](#) [MIC94094YC6-TR](#) [MIC94093YC6-TR](#) [MIC94064YC6-TR](#) [MIC94061YMT-TR](#)