



Is Now Part of



ON Semiconductor®

To learn more about ON Semiconductor, please visit our website at
www.onsemi.com

Please note: As part of the Fairchild Semiconductor integration, some of the Fairchild orderable part numbers will need to change in order to meet ON Semiconductor's system requirements. Since the ON Semiconductor product management systems do not have the ability to manage part nomenclature that utilizes an underscore (_), the underscore (_) in the Fairchild part numbers will be changed to a dash (-). This document may contain device numbers with an underscore (_). Please check the ON Semiconductor website to verify the updated device numbers. The most current and up-to-date ordering information can be found at www.onsemi.com. Please email any questions regarding the system integration to Fairchild_questions@onsemi.com.

ON Semiconductor and the ON Semiconductor logo are trademarks of Semiconductor Components Industries, LLC dba ON Semiconductor or its subsidiaries in the United States and/or other countries. ON Semiconductor owns the rights to a number of patents, trademarks, copyrights, trade secrets, and other intellectual property. A listing of ON Semiconductor's product/patent coverage may be accessed at www.onsemi.com/site/pdf/Patent-Marking.pdf. ON Semiconductor reserves the right to make changes without further notice to any products herein. ON Semiconductor makes no warranty, representation or guarantee regarding the suitability of its products for any particular purpose, nor does ON Semiconductor assume any liability arising out of the application or use of any product or circuit, and specifically disclaims any and all liability, including without limitation special, consequential or incidental damages. Buyer is responsible for its products and applications using ON Semiconductor products, including compliance with all laws, regulations and safety requirements or standards, regardless of any support or applications information provided by ON Semiconductor. "Typical" parameters which may be provided in ON Semiconductor data sheets and/or specifications can and do vary in different applications and actual performance may vary over time. All operating parameters, including "Typicals" must be validated for each customer application by customer's technical experts. ON Semiconductor does not convey any license under its patent rights nor the rights of others. ON Semiconductor products are not designed, intended, or authorized for use as a critical component in life support systems or any FDA Class 3 medical devices or medical devices with a same or similar classification in a foreign jurisdiction or any devices intended for implantation in the human body. Should Buyer purchase or use ON Semiconductor products for any such unintended or unauthorized application, Buyer shall indemnify and hold ON Semiconductor and its officers, employees, subsidiaries, affiliates, and distributors harmless against all claims, costs, damages, and expenses, and reasonable attorney fees arising out of, directly or indirectly, any claim of personal injury or death associated with such unintended or unauthorized use, even if such claim alleges that ON Semiconductor was negligent regarding the design or manufacture of the part. ON Semiconductor is an Equal Opportunity/Affirmative Action Employer. This literature is subject to all applicable copyright laws and is not for resale in any manner.

PowerTrench® Power Stage
Asymmetric Dual N-Channel MOSFET



Features

- Q1: N-Channel
 - Max $r_{DS(on)}$ = 8 mΩ at $V_{GS} = 10\text{ V}$, $I_D = 13\text{ A}$
 - Max $r_{DS(on)}$ = 11 mΩ at $V_{GS} = 4.5\text{ V}$, $I_D = 11\text{ A}$
- Q2: N-Channel
 - Max $r_{DS(on)}$ = 2.8 mΩ at $V_{GS} = 10\text{ V}$, $I_D = 23\text{ A}$
 - Max $r_{DS(on)}$ = 3.8 mΩ at $V_{GS} = 4.5\text{ V}$, $I_D = 21\text{ A}$
 - Low inductance packaging shortens rise/fall times, resulting in lower switching losses
 - MOSFET integration enables optimum layout for lower circuit inductance and reduced switch node ringing
 - RoHS Compliant



General Description

This device includes two specialized N-Channel MOSFETs in a dual PQFN package. The switch node has been internally connected to enable easy placement and routing of synchronous buck converters. The control MOSFET (Q1) and synchronous SyncFET (Q2) have been designed to provide optimal power efficiency.

Applications

- Computing
- Communications
- General Purpose Point of Load
- Notebook VCORE



Top

Power 56

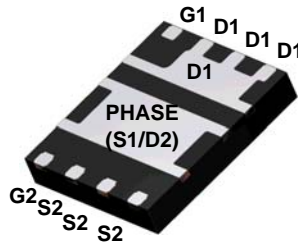

Bottom

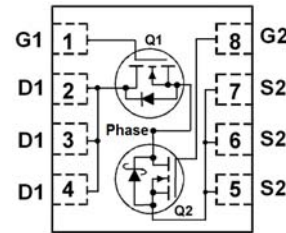

MOSFET Maximum Ratings $T_A = 25\text{ °C}$ unless otherwise noted

Symbol	Parameter	Q1	Q2	Units
V_{DS}	Drain to Source Voltage	30	30	V
V_{GS}	Gate to Source Voltage (Note 3)	±20	±20	V
I_D	Drain Current -Continuous (Package limited) $T_C = 25\text{ °C}$	30	55	A
	-Continuous (Silicon limited) $T_C = 25\text{ °C}$	54	123	
	-Continuous $T_A = 25\text{ °C}$	13 ^{1a}	23 ^{1b}	
	-Pulsed	40	100	
E_{AS}	Single Pulse Avalanche Energy	40 ⁴	60 ⁴	mJ
P_D	Power Dissipation for Single Operation $T_A = 25\text{ °C}$	2.2 ^{1a}	2.5 ^{1b}	W
	Power Dissipation for Single Operation $T_A = 25\text{ °C}$	1.0 ^{1c}	1.0 ^{1d}	
T_J, T_{STG}	Operating and Storage Junction Temperature Range	-55 to +150		°C

Thermal Characteristics

$R_{\theta JA}$	Thermal Resistance, Junction to Ambient	57 ^{1a}	50 ^{1b}	°C/W
$R_{\theta JA}$	Thermal Resistance, Junction to Ambient	125 ^{1c}	120 ^{1d}	
$R_{\theta JC}$	Thermal Resistance, Junction to Case	3.5	2.0	

Package Marking and Ordering Information

Device Marking	Device	Package	Reel Size	Tape Width	Quantity
22CA F10CC	FDMS3686S	Power 56	13 "	12 mm	3000 units

Electrical Characteristics $T_J = 25\text{ }^\circ\text{C}$ unless otherwise noted

Symbol	Parameter	Test Conditions	Type	Min	Typ	Max	Units
--------	-----------	-----------------	------	-----	-----	-----	-------

Off Characteristics

BV_{DSS}	Drain to Source Breakdown Voltage	$I_D = 250\text{ }\mu\text{A}$, $V_{GS} = 0\text{ V}$ $I_D = 1\text{ mA}$, $V_{GS} = 0\text{ V}$	Q1 Q2	30 30			V
$\frac{\Delta BV_{DSS}}{\Delta T_J}$	Breakdown Voltage Temperature Coefficient	$I_D = 250\text{ }\mu\text{A}$, referenced to $25\text{ }^\circ\text{C}$ $I_D = 10\text{ mA}$, referenced to $25\text{ }^\circ\text{C}$	Q1 Q2		15 19		mV/ $^\circ\text{C}$
I_{DSS}	Zero Gate Voltage Drain Current	$V_{DS} = 24\text{ V}$, $V_{GS} = 0\text{ V}$	Q1 Q2			1 500	μA μA
I_{GSS}	Gate to Source Leakage Current, Forward	$V_{GS} = 20\text{ V}$, $V_{DS} = 0\text{ V}$	Q1 Q2			100 100	nA nA

On Characteristics

$V_{GS(th)}$	Gate to Source Threshold Voltage	$V_{GS} = V_{DS}$, $I_D = 250\text{ }\mu\text{A}$ $V_{GS} = V_{DS}$, $I_D = 1\text{ mA}$	Q1 Q2	1.1 1.1	2 1.5	2.7 3.0	V
$\frac{\Delta V_{GS(th)}}{\Delta T_J}$	Gate to Source Threshold Voltage Temperature Coefficient	$I_D = 250\text{ }\mu\text{A}$, referenced to $25\text{ }^\circ\text{C}$ $I_D = 10\text{ mA}$, referenced to $25\text{ }^\circ\text{C}$	Q1 Q2		-6 -4		mV/ $^\circ\text{C}$
$r_{DS(on)}$	Drain to Source On Resistance	$V_{GS} = 10\text{ V}$, $I_D = 13\text{ A}$ $V_{GS} = 4.5\text{ V}$, $I_D = 11\text{ A}$ $V_{GS} = 10\text{ V}$, $I_D = 13\text{ A}$, $T_J = 125\text{ }^\circ\text{C}$	Q1		5.8 8.5 7.8	8 11 10.8	m Ω
		$V_{GS} = 10\text{ V}$, $I_D = 23\text{ A}$ $V_{GS} = 4.5\text{ V}$, $I_D = 21\text{ A}$ $V_{GS} = 10\text{ V}$, $I_D = 23\text{ A}$, $T_J = 125\text{ }^\circ\text{C}$	Q2		2.2 3.0 3.1	2.8 3.8 4.0	
g_{FS}	Forward Transconductance	$V_{DS} = 5\text{ V}$, $I_D = 13\text{ A}$ $V_{DS} = 5\text{ V}$, $I_D = 23\text{ A}$	Q1 Q2		61 124		S

Dynamic Characteristics

C_{iss}	Input Capacitance	Q1: $V_{DS} = 15\text{ V}$, $V_{GS} = 0\text{ V}$, $f = 1\text{ MHz}$	Q1 Q2		1340 1820	1785 2420	pF
C_{oss}	Output Capacitance	Q2: $V_{DS} = 15\text{ V}$, $V_{GS} = 0\text{ V}$, $f = 1\text{ MHz}$	Q1 Q2		485 725	645 965	pF
C_{riss}	Reverse Transfer Capacitance	$V_{DS} = 15\text{ V}$, $V_{GS} = 0\text{ V}$, $f = 1\text{ MHz}$	Q1 Q2		53 86	80 130	pF
R_g	Gate Resistance		Q1 Q2	0.2 0.2	0.6 0.9	2 3	Ω

Switching Characteristics

$t_{d(on)}$	Turn-On Delay Time	Q1: $V_{DD} = 15\text{ V}$, $I_D = 13\text{ A}$, $R_{GEN} = 6\text{ }\Omega$ Q2: $V_{DD} = 15\text{ V}$, $I_D = 23\text{ A}$, $R_{GEN} = 6\text{ }\Omega$	Q1 Q2		8.2 9	16 18	ns	
t_r	Rise Time		Q1 Q2		2.5 4	10 10	ns	
$t_{d(off)}$	Turn-Off Delay Time		Q1 Q2		20 23	32 36	ns	
t_f	Fall Time		Q1 Q2		2.2 3	10 10	ns	
Q_g	Total Gate Charge	$V_{GS} = 0\text{ V}$ to 10 V $V_{GS} = 0\text{ V}$ to 4.5 V	Q1 $V_{DD} = 15\text{ V}$, $I_D = 13\text{ A}$	Q1 Q2		21 27	29 37	nC
				Q1 Q2		10 13	14 18	
Q_{gs}	Gate to Source Gate Charge	Q2 $V_{DD} = 15\text{ V}$, $I_D = 23\text{ A}$	Q1 Q2		3.9 4.6		nC	
Q_{gd}	Gate to Drain "Miller" Charge		Q1 Q2		3.1 3.7			

Electrical Characteristics $T_J = 25\text{ }^\circ\text{C}$ unless otherwise noted

Symbol	Parameter	Test Conditions	Type	Min	Typ	Max	Units
--------	-----------	-----------------	------	-----	-----	-----	-------

Drain-Source Diode Characteristics

V_{SD}	Source to Drain Diode Forward Voltage	$V_{GS} = 0\text{ V}, I_S = 2\text{ A}$ (Note 2)	Q1		0.72	1.2	V
		$V_{GS} = 0\text{ V}, I_S = 13\text{ A}$ (Note 2)	Q1		0.82	1.2	
		$V_{GS} = 0\text{ V}, I_S = 2\text{ A}$ (Note 2)	Q2		0.58	1.2	
		$V_{GS} = 0\text{ V}, I_S = 23\text{ A}$ (Note 2)	Q2		0.76	1.2	
t_{rr}	Reverse Recovery Time	Q1 $I_F = 13\text{ A}, di/dt = 100\text{ A}/\mu\text{s}$	Q1		25	40	ns
			Q2		25	39	
Q_{rr}	Reverse Recovery Charge	Q2 $I_F = 23\text{ A}, di/dt = 300\text{ A}/\mu\text{s}$	Q1		9	18	nC
			Q2		23	36	

Notes:

1. R_{qJA} is determined with the device mounted on a 1 in² pad 2 oz copper pad on a 1.5 x 1.5 in. board of FR-4 material. R_{qJC} is guaranteed by design while R_{qCA} is determined by the user's board design.

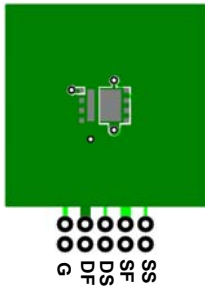

a. 57 °C/W when mounted on a 1 in² pad of 2 oz copper

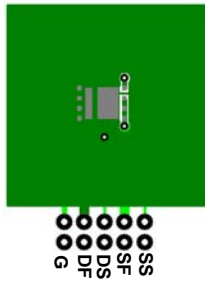

b. 50 °C/W when mounted on a 1 in² pad of 2 oz copper



c. 125 °C/W when mounted on a minimum pad of 2 oz copper

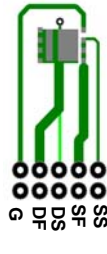

d. 120 °C/W when mounted on a minimum pad of 2 oz copper

2. Pulse Test: Pulse Width < 300 ms, Duty cycle < 2.0%.

3. As an N-ch device, the negative Vgs rating is for low duty cycle pulse occurrence only. No continuous rating is implied.

4. Q1: E_{AS} of 40 mJ is based on starting $T_J = 25\text{ }^\circ\text{C}$; N-ch: $L = 1\text{ mH}$, $I_{AS} = 9\text{ A}$, $V_{DD} = 27\text{ V}$, $V_{GS} = 10\text{ V}$. 100% test at $L = 0.3\text{ mH}$, $I_{AS} = 14\text{ A}$.
Q2: E_{AS} of 60 mJ is based on starting $T_J = 25\text{ }^\circ\text{C}$; N-ch: $L = 1\text{ mH}$, $I_{AS} = 11\text{ A}$, $V_{DD} = 27\text{ V}$, $V_{GS} = 10\text{ V}$. 100% test at $L = 0.3\text{ mH}$, $I_{AS} = 17\text{ A}$.

Typical Characteristics (Q1 N-Channel) $T_J = 25\text{ }^\circ\text{C}$ unless otherwise noted

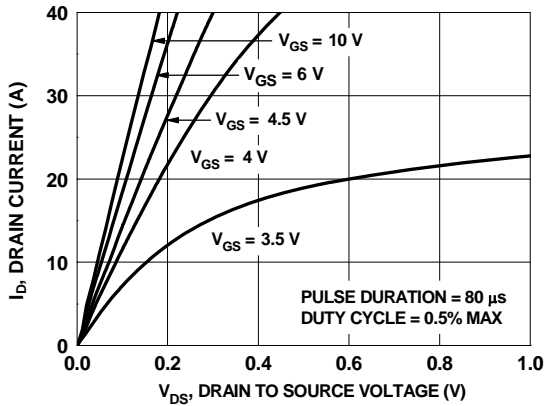

Figure 1. On Region Characteristics

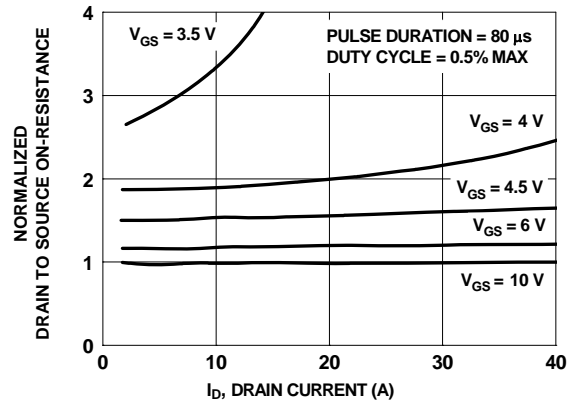

Figure 2. Normalized On-Resistance vs Drain Current and Gate Voltage

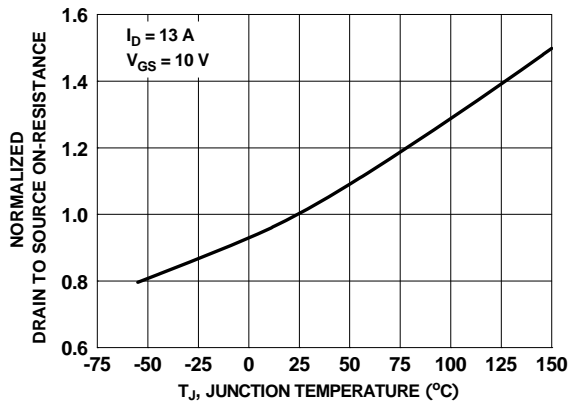

Figure 3. Normalized On Resistance vs Junction Temperature

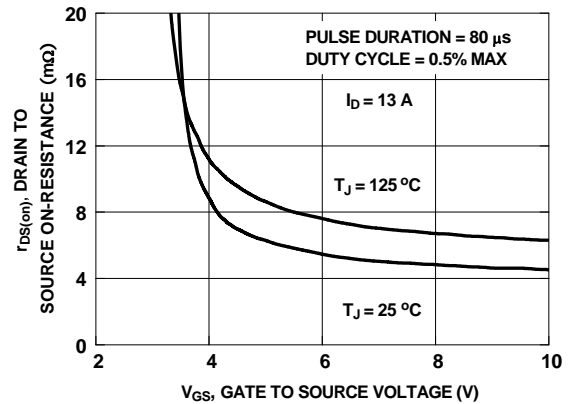

Figure 4. On-Resistance vs Gate to Source Voltage

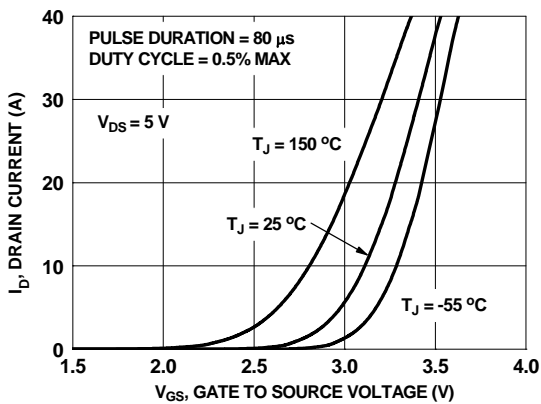

Figure 5. Transfer Characteristics

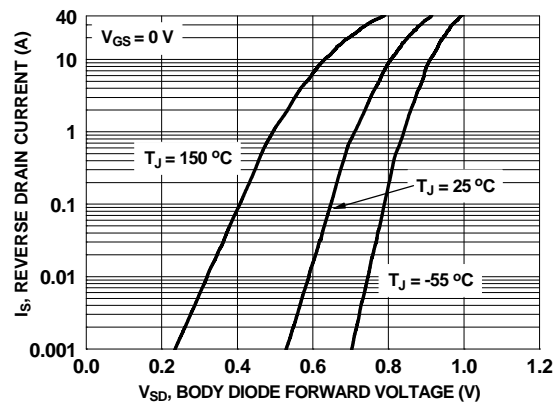

Figure 6. Source to Drain Diode Forward Voltage vs Source Current

Typical Characteristics (Q1 N-Channel) $T_J = 25^\circ\text{C}$ unless otherwise noted

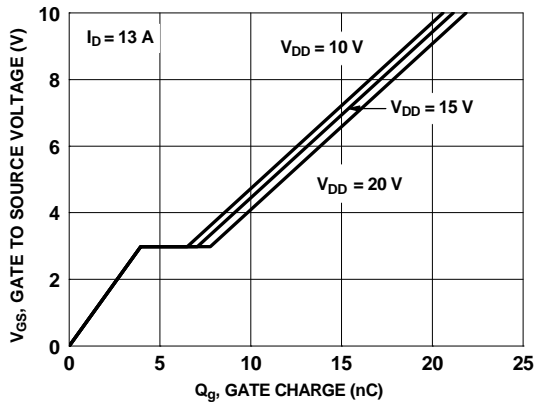

Figure 7. Gate Charge Characteristics

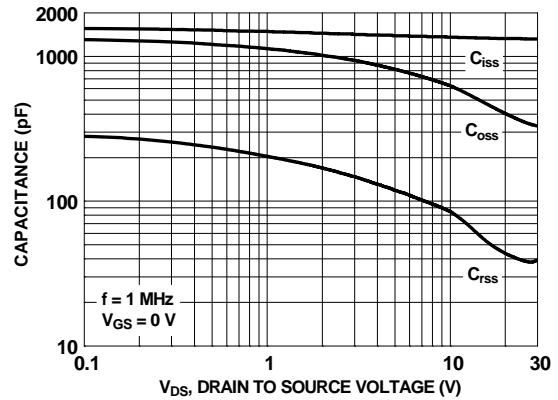

Figure 8. Capacitance vs Drain to Source Voltage

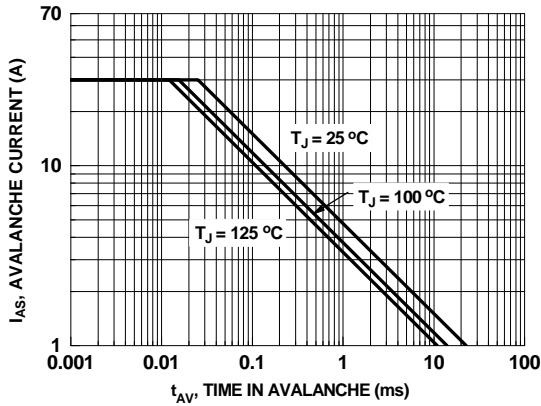

Figure 9. Unclamped Inductive Switching Capability

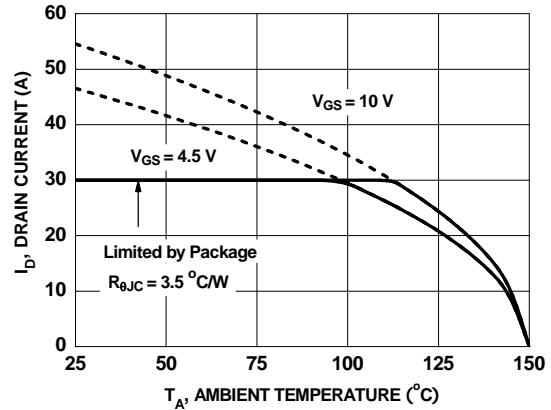

Figure 10. Maximum Continuous Drain Current vs Case Temperature

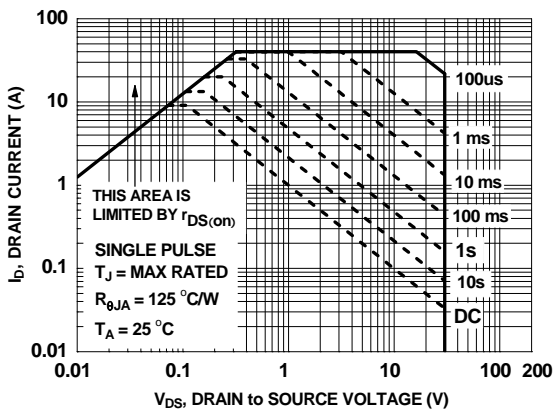

Figure 11. Forward Bias Safe Operating Area

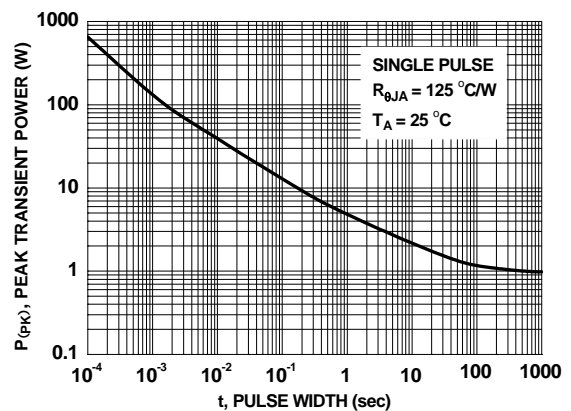

Figure 12. Single Pulse Maximum Power Dissipation

Typical Characteristics (Q1 N-Channel) $T_J = 25\text{ }^\circ\text{C}$ unless otherwise noted

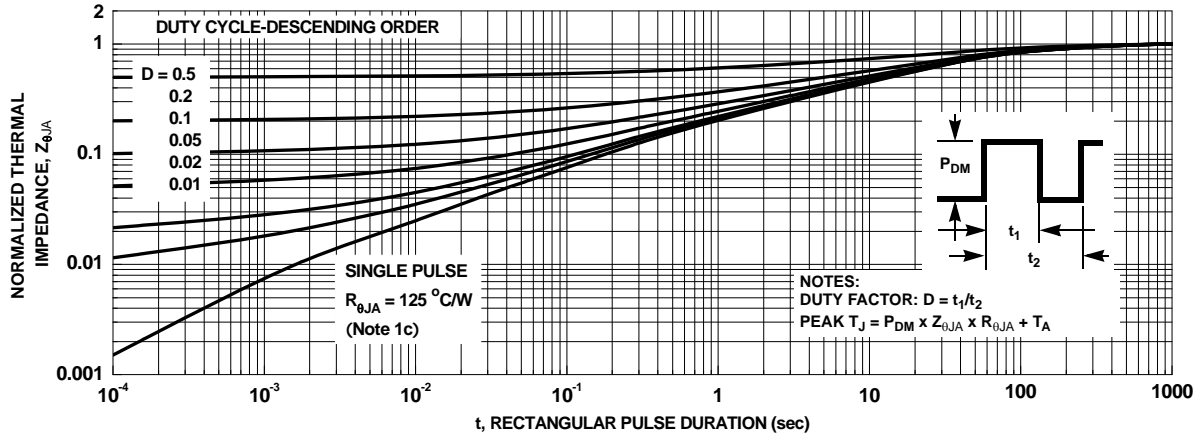

Figure 13. Junction-to-Ambient Transient Thermal Response Curve

Typical Characteristics (Q2 N-Channel) $T_J = 25^\circ\text{C}$ unless otherwise noted

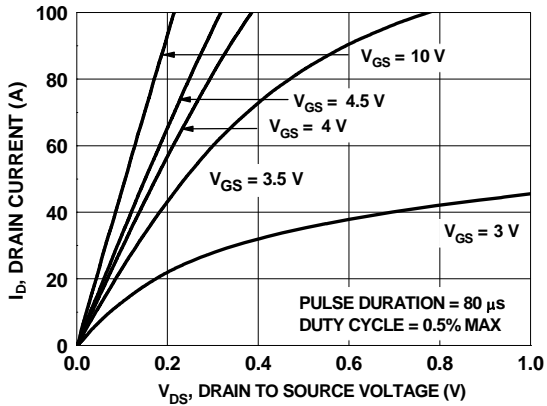

Figure 14. On-Region Characteristics

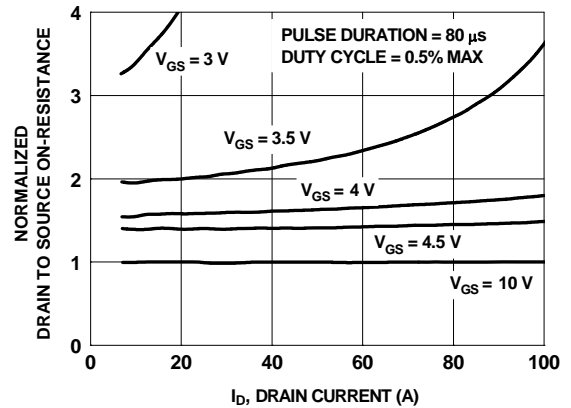

Figure 15. Normalized on-Resistance vs Drain Current and Gate Voltage

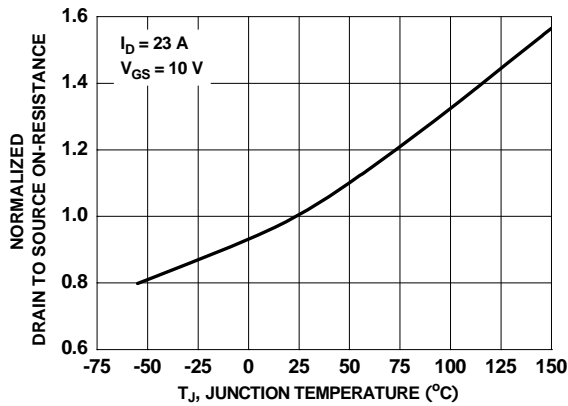

Figure 16. Normalized On-Resistance vs Junction Temperature

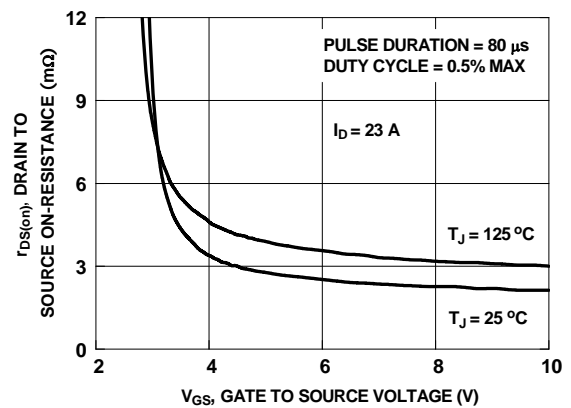

Figure 17. On-Resistance vs Gate to Source Voltage

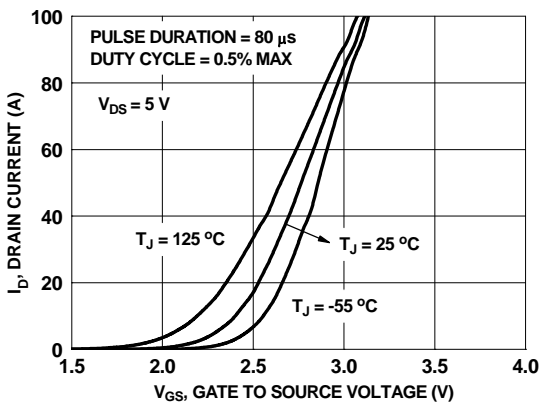

Figure 18. Transfer Characteristics

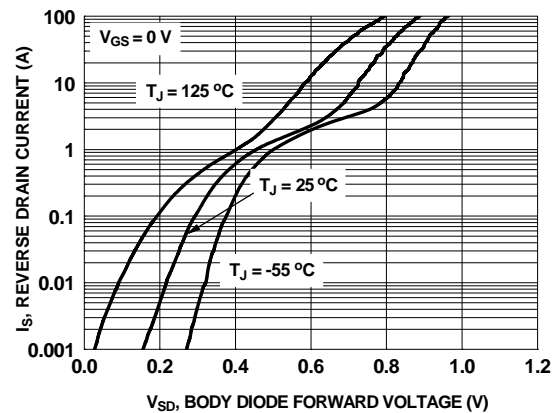

Figure 19. Source to Drain Diode Forward Voltage vs Source Current

Typical Characteristics (Q2 N-Channel) $T_J = 25\text{ }^\circ\text{C}$ unless otherwise noted

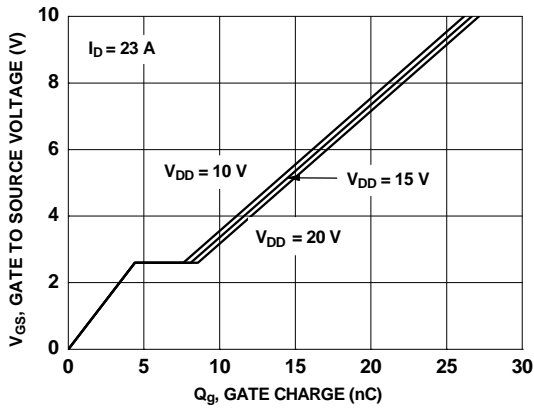

Figure 20. Gate Charge Characteristics

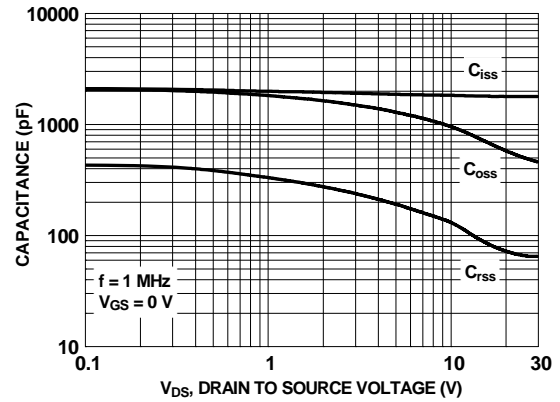

Figure 21. Capacitance vs Drain to Source Voltage

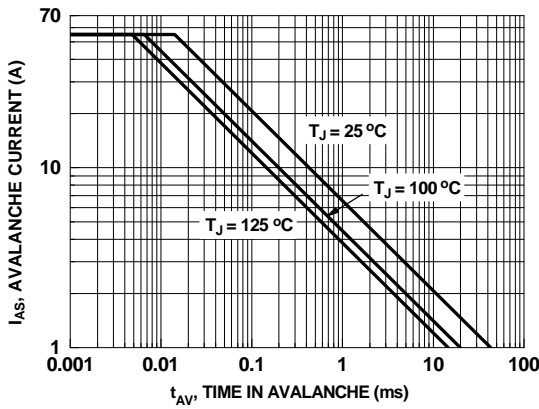

Figure 22. Unclamped Inductive Switching Capability

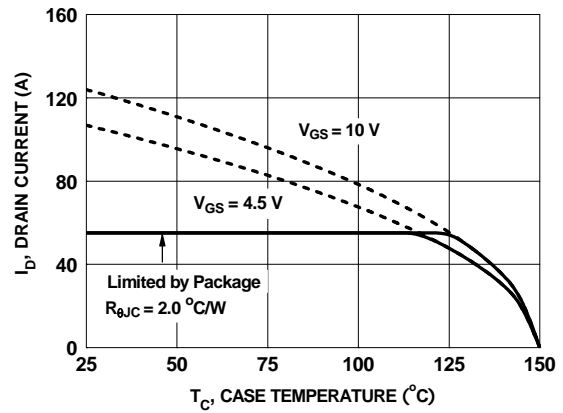

Figure 23. Maximum Continuous Drain Current vs Case Temperature

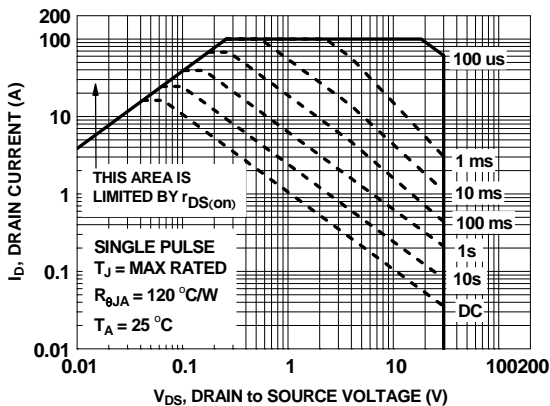

Figure 24. Forward Bias Safe Operating Area

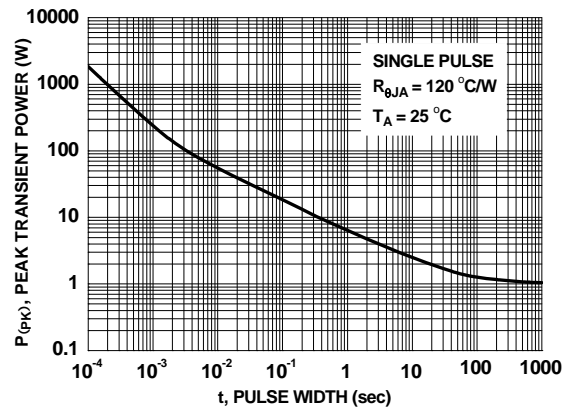

Figure 25. Single Pulse Maximum Power Dissipation

Typical Characteristics (Q2 N-Channel) $T_J = 25\text{ }^\circ\text{C}$ unless otherwise noted

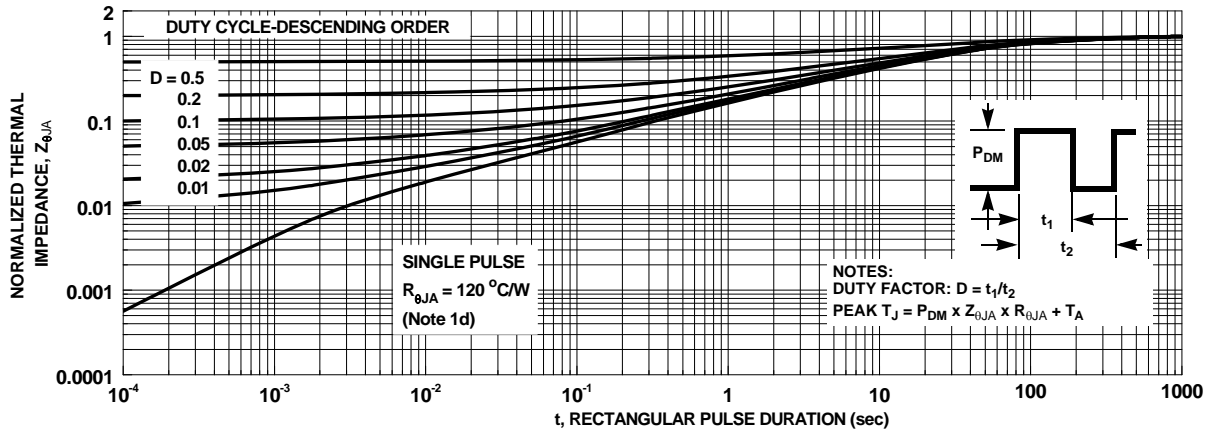

Figure 26. Junction-to-Ambient Transient Thermal Response Curve

Typical Characteristics (continued)

SyncFET Schottky body diode Characteristics

Fairchild's SyncFET process embeds a Schottky diode in parallel with PowerTrench MOSFET. This diode exhibits similar characteristics to a discrete external Schottky diode in parallel with a MOSFET. Figure 27 shows the reverse recovery characteristic of the FDMS3686S.

Schottky barrier diodes exhibit significant leakage at high temperature and high reverse voltage. This will increase the power in the device.

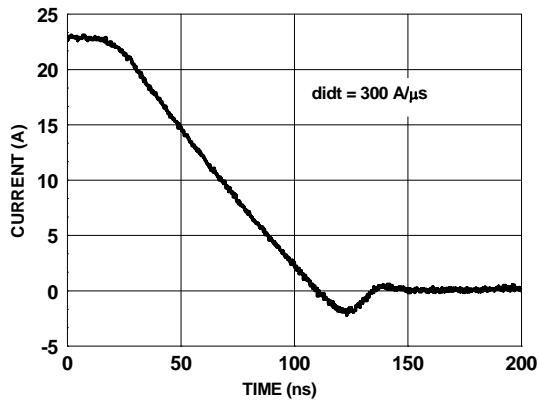

Figure 27. FDMS3686S SyncFET body diode reverse recovery characteristic

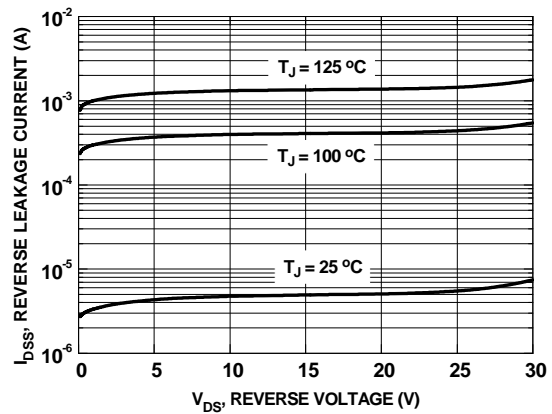

Figure 28. SyncFET body diode reverse leakage versus drain-source voltage

Application Information

1. Switch Node Ringing Suppression

Fairchild's Power Stage products incorporate a proprietary design* that minimizes the peak overshoot, ringing voltage on the switch node (PHASE) without the need of any external snubbing components in a buck converter. As shown in the figure 29, the Power Stage solution rings significantly less than competitor solutions under the same set of test conditions.

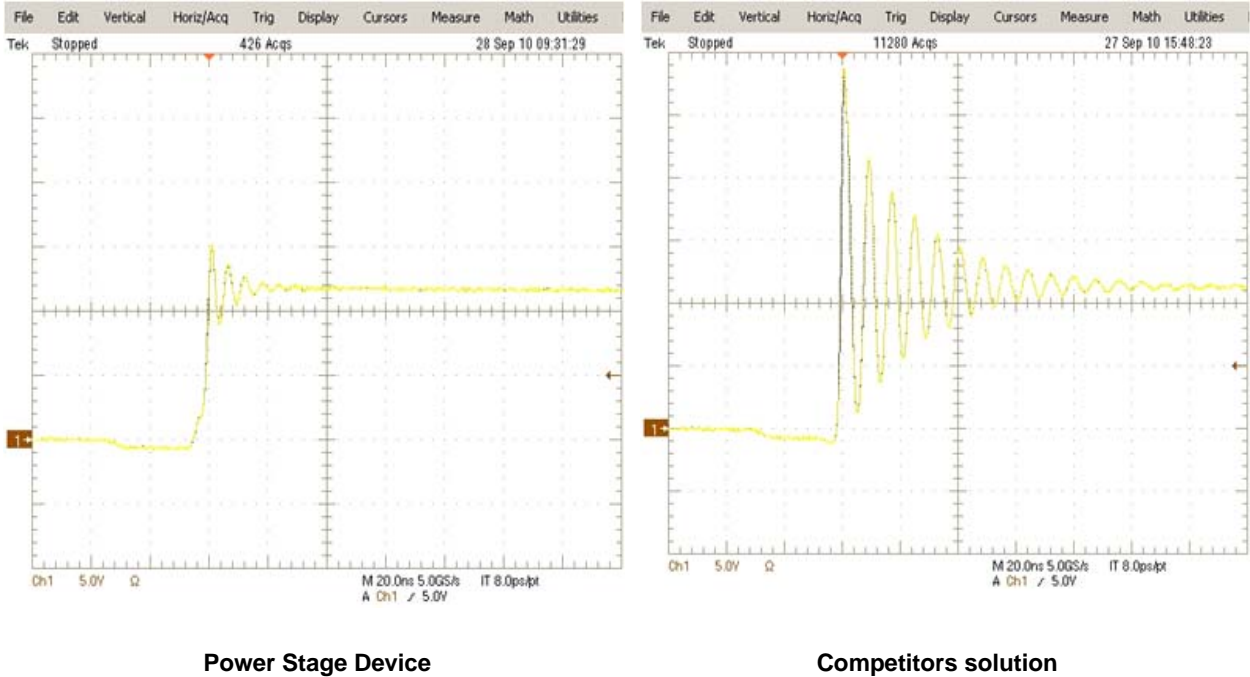
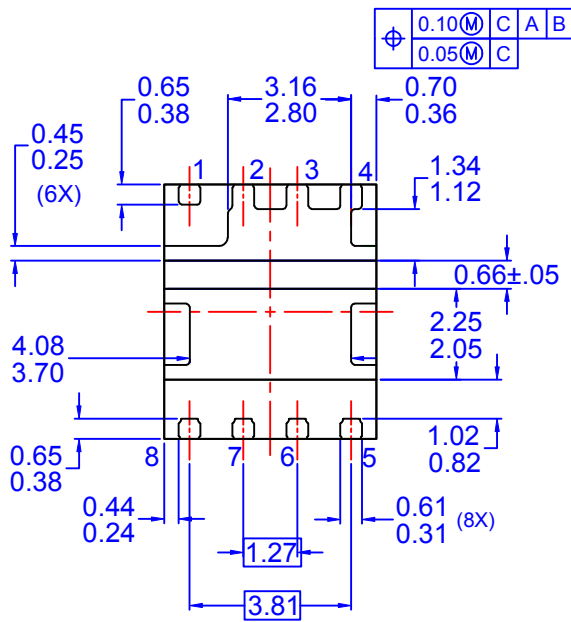
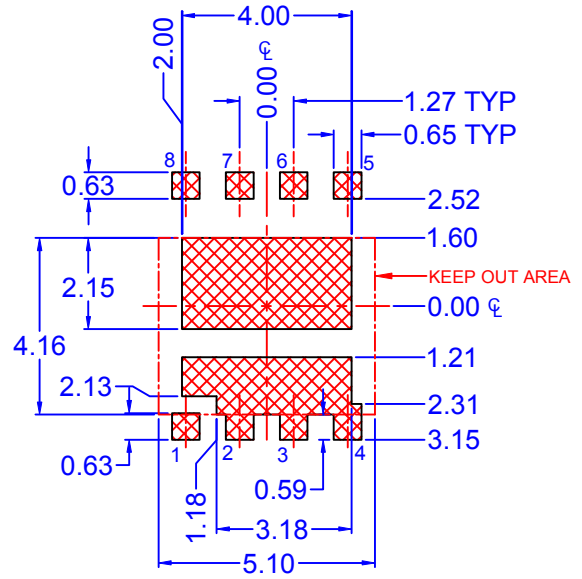
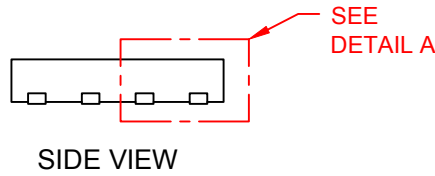
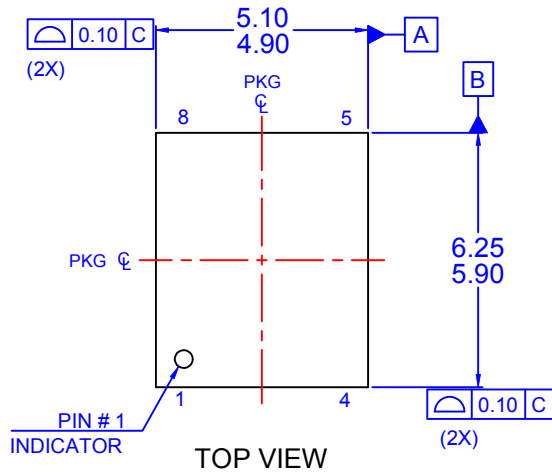

Figure 29. Power Stage phase node rising edge, High Side Turn on

*Patent Pending

Following is a guideline, not a requirement which the PCB designer should consider:

1. Input ceramic bypass capacitors C1 and C2 must be placed close to the D1 and S2 pins of Power Stage to help reduce parasitic inductance and High Frequency conduction loss induced by switching operation. C1 and C2 show the bypass capacitors placed close to the part between D1 and S2. Input capacitors should be connected in parallel close to the part. Multiple input caps can be connected depending upon the application.
2. The PHASE copper trace serves two purposes; In addition to being the current path from the Power Stage package to the output inductor (L), it also serves as heat sink for the lower FET in the Power Stage package. The trace should be short and wide enough to present a low resistance path for the high current flow between the Power Stage and the inductor. This is done to minimize conduction losses and limit temperature rise. Please note that the PHASE node is a high voltage and high frequency switching node with high noise potential. Care should be taken to minimize coupling to adjacent traces. The reference layout in figure 31 shows a good balance between the thermal and electrical performance of Power Stage.
3. Output inductor location should be as close as possible to the Power Stage device for lower power loss due to copper trace resistance. A shorter and wider PHASE trace to the inductor reduces the conduction loss. Preferably the Power Stage should be directly in line (as shown in figure 31) with the inductor for space savings and compactness.
4. The PowerTrench® Technology MOSFETs used in the Power Stage are effective at minimizing phase node ringing. It allows the part to operate well within the breakdown voltage limits. This eliminates the need to have an external snubber circuit in most cases. If the designer chooses to use an RC snubber, it should be placed close to the part between the PHASE pad and S2 pins to dampen the high-frequency ringing.
5. The driver IC should be placed close to the Power Stage part with the shortest possible paths for the High Side gate and Low Side gates through a wide trace connection. This eliminates the effect of parasitic inductance and resistance between the driver and the MOSFET and turns the devices on and off as efficiently as possible. At higher-frequency operation this impedance can limit the gate current trying to charge the MOSFET input capacitance. This will result in slower rise and fall times and additional switching losses. Power Stage has both the gate pins on the same side of the package which allows for back mounting of the driver IC to the board. This provides a very compact path for the drive signals and improves efficiency of the part.
6. S2 pins should be connected to the GND plane with multiple vias for a low impedance grounding. Poor grounding can create a noise transient offset voltage level between S2 and driver ground. This could lead to faulty operation of the gate driver and MOSFET.
7. Use multiple vias on each copper area to interconnect top, inner and bottom layers to help smooth current flow and heat conduction. Vias should be relatively large, around 8 mils to 10 mils, and of reasonable inductance. Critical high frequency components such as ceramic bypass caps should be located close to the part and on the same side of the PCB. If not feasible, they should be connected from the backside via a network of low inductance vias.



OPTION - A (SAWN TYPE)

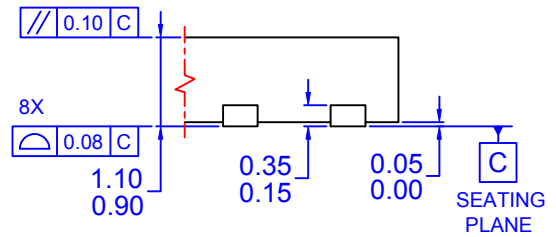

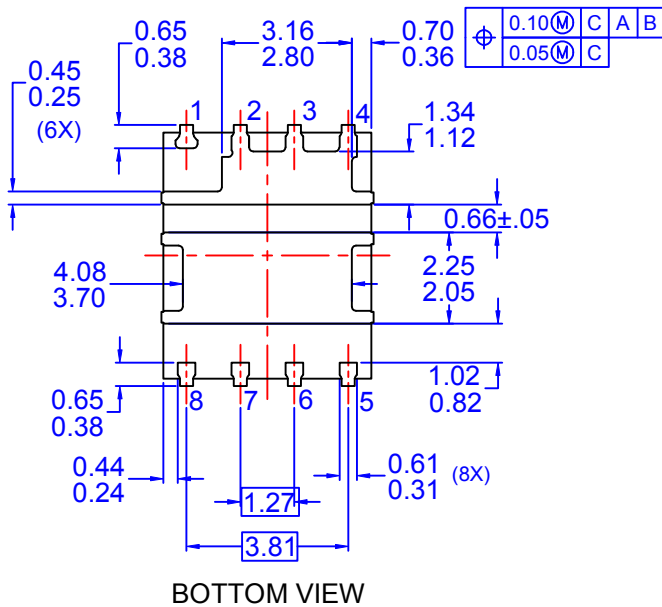
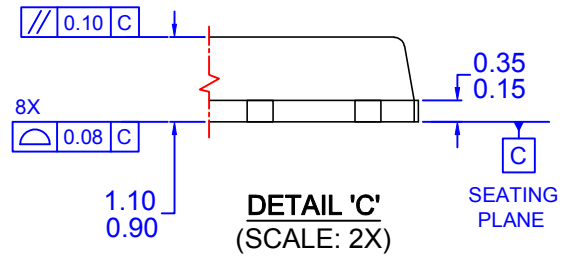
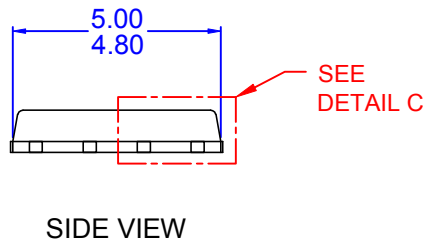
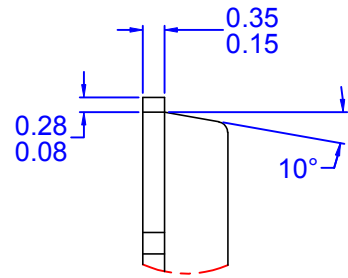
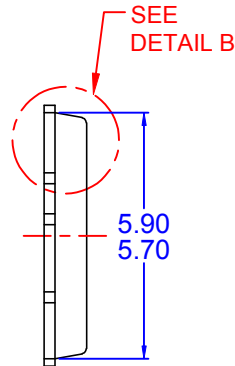
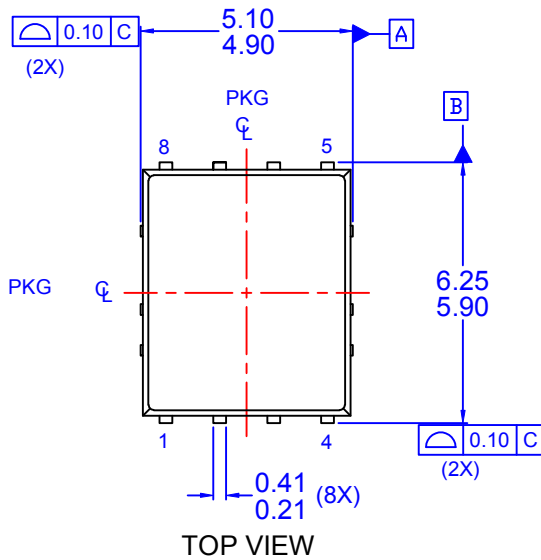

OPTION - B (PUNCHED TYPE)

- NOTES: UNLESS OTHERWISE SPECIFIED
- A) PACKAGE STANDARD REFERENCE:
JEDEC REGISTRATION, MO-240, VARIATION AA.
 - B) ALL DIMENSIONS ARE IN MILLIMETERS.
 - C) DIMENSIONS DO NOT INCLUDE BURRS OR MOLD FLASH. MOLD FLASH OR BURRS DOES NOT EXCEED 0.10MM.
 - D) DIMENSIONING AND TOLERANCING PER ASME Y14.5M-1994.
 - E) IT IS RECOMMENDED TO HAVE NO TRACES OR VIAS WITHIN THE KEEP OUT AREA.
 - F) DRAWING FILE NAME: PQFN08EREV6.
 - G) FAIRCHILD SEMICONDUCTOR

ON Semiconductor and  are trademarks of Semiconductor Components Industries, LLC dba ON Semiconductor or its subsidiaries in the United States and/or other countries. ON Semiconductor owns the rights to a number of patents, trademarks, copyrights, trade secrets, and other intellectual property. A listing of ON Semiconductor's product/patent coverage may be accessed at www.onsemi.com/site/pdf/Patent-Marking.pdf. ON Semiconductor reserves the right to make changes without further notice to any products herein. ON Semiconductor makes no warranty, representation or guarantee regarding the suitability of its products for any particular purpose, nor does ON Semiconductor assume any liability arising out of the application or use of any product or circuit, and specifically disclaims any and all liability, including without limitation special, consequential or incidental damages. Buyer is responsible for its products and applications using ON Semiconductor products, including compliance with all laws, regulations and safety requirements or standards, regardless of any support or applications information provided by ON Semiconductor. "Typical" parameters which may be provided in ON Semiconductor data sheets and/or specifications can and do vary in different applications and actual performance may vary over time. All operating parameters, including "Typicals" must be validated for each customer application by customer's technical experts. ON Semiconductor does not convey any license under its patent rights nor the rights of others. ON Semiconductor products are not designed, intended, or authorized for use as a critical component in life support systems or any FDA Class 3 medical devices or medical devices with a same or similar classification in a foreign jurisdiction or any devices intended for implantation in the human body. Should Buyer purchase or use ON Semiconductor products for any such unintended or unauthorized application, Buyer shall indemnify and hold ON Semiconductor and its officers, employees, subsidiaries, affiliates, and distributors harmless against all claims, costs, damages, and expenses, and reasonable attorney fees arising out of, directly or indirectly, any claim of personal injury or death associated with such unintended or unauthorized use, even if such claim alleges that ON Semiconductor was negligent regarding the design or manufacture of the part. ON Semiconductor is an Equal Opportunity/Affirmative Action Employer. This literature is subject to all applicable copyright laws and is not for resale in any manner.

PUBLICATION ORDERING INFORMATION

LITERATURE FULFILLMENT:

Literature Distribution Center for ON Semiconductor
19521 E. 32nd Pkwy, Aurora, Colorado 80011 USA
Phone: 303-675-2175 or 800-344-3860 Toll Free USA/Canada
Fax: 303-675-2176 or 800-344-3867 Toll Free USA/Canada
Email: orderlit@onsemi.com

N. American Technical Support: 800-282-9855 Toll Free
USA/Canada
Europe, Middle East and Africa Technical Support:
Phone: 421 33 790 2910
Japan Customer Focus Center
Phone: 81-3-5817-1050

ON Semiconductor Website: www.onsemi.com
Order Literature: <http://www.onsemi.com/orderlit>
For additional information, please contact your local
Sales Representative

X-ON Electronics

Largest Supplier of Electrical and Electronic Components

Click to view similar products for [MOSFET](#) category:

Click to view products by [ON Semiconductor](#) manufacturer:

Other Similar products are found below :

[614233C](#) [648584F](#) [IRFD120](#) [JANTX2N5237](#) [FCA20N60_F109](#) [FDZ595PZ](#) [2SK2545\(Q,T\)](#) [405094E](#) [423220D](#) [TPCC8103,L1Q\(CM](#)
[MIC4420CM-TR](#) [VN1206L](#) [SBVS138LT1G](#) [614234A](#) [715780A](#) [NTNS3166NZT5G](#) [SSM6J414TU,LF\(T](#) [751625C](#) [BUK954R8-60E](#)
[NTE6400](#) [SQJ402EP-T1-GE3](#) [2SK2614\(TE16L1,Q\)](#) [2N7002KW-FAI](#) [DMN1017UCP3-7](#) [EFC2J004NUZTDG](#) [ECH8691-TL-W](#)
[FCAB21350L1](#) [P85W28HP2F-7071](#) [DMN1053UCP4-7](#) [NTE221](#) [NTE222](#) [NTE2384](#) [NTE2903](#) [NTE2941](#) [NTE2945](#) [NTE2946](#) [NTE2960](#)
[NTE2967](#) [NTE2969](#) [NTE2976](#) [NTE455](#) [NTE6400A](#) [NTE2910](#) [NTE2916](#) [NTE2956](#) [NTE2911](#) [DMN2080UCB4-7](#) [TK10A80W,S4X\(S](#)
[SSM6P69NU,LF](#) [DMP22D4UFO-7B](#)