

# MOSFET - N-Channel, POWERTRENCH<sup>®</sup>, DUAL COOL<sup>®</sup> 56 Shielded Gate

100 V, 60 A, 7.5 mΩ

## FDMS86101DC

### General Description

This N-Channel MOSFET is produced using onsemi's advanced POWERTRENCH<sup>®</sup> process that incorporates Shielded Gate technology. Advancements in both silicon and DUAL COOL<sup>®</sup> package technologies have been combined to offer the lowest  $r_{DS(on)}$  while maintaining excellent switching performance by extremely low Junction-to-Ambient thermal resistance.

### Features

- Shielded Gate MOSFET Technology
- DUAL COOL Top Side Cooling PQFN package
- Max  $R_{DS(on)}$  = 7.5 mΩ at  $V_{GS} = 10$  V,  $I_D = 14.5$  A
- Max  $R_{DS(on)}$  = 12 mΩ at  $V_{GS} = 6$  V,  $I_D = 11.5$  A
- High performance technology for extremely low  $R_{DS(on)}$
- 100% UIL Tested
- RoHS Compliant

### Typical Applications

- Primary DC-DC MOSFET
- Secondary Synchronous Rectifier
- Load Switch

### ELECTRICAL CONNECTION

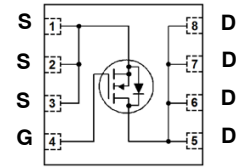

N-Channel MOSFET

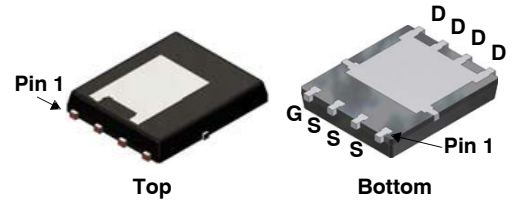

DFN8 5.1x6.15  
(Dual Cool 56)  
CASE 506EG

### MARKING DIAGRAM

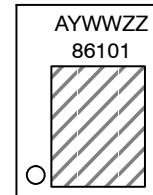

- 86101 = Device Code
- A = Assy Location
- Y = Year Code
- WW = Work Week Code
- ZZ = Assy Lot Code

### ORDERING INFORMATION

See detailed ordering, marking and shipping information on page 2 of this data sheet.

# FDMS86101DC

## PACKAGE MARKING AND ORDERING INFORMATION

Device Marking	Device	Package	Reel Size	Tape Width	Shipping†
86101	FDMS86101DC	UDFN8	13"	12 mm	3000 Units/ Tape & Reel

†For information on tape and reel specifications, including part orientation and tape sizes, please refer to our Tape and Reel Packaging Specifications Brochure, BRD8011/D.

## MOSFET MAXIMUM RATINGS ( $T_A = 25^\circ\text{C}$ unless otherwise noted)

Symbol	Parameter	Ratings	Units
$V_{DS}$	Drain to Source Voltage	100	V
$V_{GS}$	Gate to Source Voltage	$\pm 20$	V
$I_D$	Drain Current –Continuous $T_C = 25^\circ\text{C}$	60	A
	–Continuous $T_A = 25^\circ\text{C}$ (Note 1a)	14.5	
	–Pulsed	200	
$E_{AS}$	Single Pulse Avalanche Energy (Note 3)	216	mJ
$P_D$	Power Dissipation $T_C = 25^\circ\text{C}$	125	W
	Power Dissipation $T_A = 25^\circ\text{C}$ (Note 1a)	3.2	
$T_J, T_{STG}$	Operating and Storage Junction Temperature Range	$-55$ to $+150$	$^\circ\text{C}$

Stresses exceeding those listed in the Maximum Ratings table may damage the device. If any of these limits are exceeded, device functionality should not be assumed, damage may occur and reliability may be affected.

## ELECTRICAL CHARACTERISTICS ( $T_J = 25^\circ\text{C}$ unless otherwise noted)

Symbol	Parameter	Test Conditions	Min.	Typ.	Max.	Units
--------	-----------	-----------------	------	------	------	-------

### OFF CHARACTERISTICS

$BV_{DSS}$	Drain to Source Breakdown Voltage	$I_D = 250 \mu\text{A}, V_{GS} = 0 \text{ V}$	100			V
$\frac{\Delta BV_{DSS}}{\Delta T_J}$	Breakdown Voltage Temperature Coefficient	$I_D = 250 \mu\text{A}$ , referenced to $25^\circ\text{C}$		70		$\text{mV}/^\circ\text{C}$
$I_{DSS}$	Zero Gate Voltage Drain Current	$V_{DS} = 80 \text{ V}, V_{GS} = 0 \text{ V}$			1	$\mu\text{A}$
$I_{GSS}$	Gate to Source Leakage Current	$V_{GS} = \pm 20 \text{ V}, V_{DS} = 0 \text{ V}$			$\pm 100$	nA

### ON CHARACTERISTICS

$V_{GS(th)}$	Gate to Source Threshold Voltage	$V_{GS} = V_{DS}, I_D = 250 \mu\text{A}$	2	2.7	4	V
$\frac{\Delta V_{GS(th)}}{\Delta T_J}$	Gate to Source Threshold Voltage Temperature Coefficient	$I_D = 250 \mu\text{A}$ , referenced to $25^\circ\text{C}$		-10		$\text{mV}/^\circ\text{C}$
$r_{DS(on)}$	Static Drain to Source On Resistance	$V_{GS} = 10 \text{ V}, I_D = 14.5 \text{ A}$		6	7.5	$\text{m}\Omega$
		$V_{GS} = 6 \text{ V}, I_D = 11.5 \text{ A}$		8.3	12	
		$V_{GS} = 10 \text{ V}, I_D = 14.5 \text{ A}, T_J = 125^\circ\text{C}$		10	13	
$g_{FS}$	Forward Transconductance	$V_{DD} = 10 \text{ V}, I_D = 14.5 \text{ A}$		44		S

### DYNAMIC CHARACTERISTICS

$C_{ISS}$	Input Capacitance	$V_{DS} = 50 \text{ V}, V_{GS} = 0 \text{ V}, f = 1 \text{ MHz}$		2354	3135	$\text{pF}$
$C_{OSS}$	Output Capacitance			467	625	$\text{pF}$
$C_{RSS}$	Reverse Transfer Capacitance			23	35	$\text{pF}$
$R_G$	Gate Resistance			0.1	1.4	3

# FDMS86101DC

## ELECTRICAL CHARACTERISTICS (T<sub>J</sub> = 25°C unless otherwise noted)

Symbol	Parameter	Test Conditions	Min.	Typ.	Max.	Units
--------	-----------	-----------------	------	------	------	-------

### SWITCHING CHARACTERISTICS

t <sub>d(ON)</sub>	Turn – On Delay Time	V <sub>DD</sub> = 50 V, I <sub>D</sub> = 14.5 A, V <sub>GS</sub> = 10 V, R <sub>GEN</sub> = 6 Ω		14	25	ns
t <sub>r</sub>	Rise Time			8.2	17	ns
t <sub>D(OFF)</sub>	Turn – Off Delay Time			25	40	ns
t <sub>f</sub>	Fall Time			5.5	11	ns
Q <sub>g(TOT)</sub>	Total Gate Charge	V <sub>GS</sub> = 0 V to 10 V V <sub>GS</sub> = 0 V to 5 V		31	44	nC
	Total Gate Charge			18	25	nC
Q <sub>gs</sub>	Gate to Source Gate Charge	V <sub>DD</sub> = 50 V, I <sub>D</sub> = 14.5 A		8.3		nC
Q <sub>gd</sub>	Gate to Drain "Miller" Charge			7		nC

### DRAIN-SOURCE DIODE CHARACTERISTICS

V <sub>SD</sub>	Source to Drain Diode Forward Voltage	V <sub>GS</sub> = 0 V, I <sub>S</sub> = 2.7 A (Note 2)		0.71	1.2	V
		V <sub>GS</sub> = 0 V, I <sub>S</sub> = 14.5 A (Note 2)		0.78	1.3	
t <sub>rr</sub>	Reverse Recovery Time	I <sub>F</sub> = 14.5 A, di/dt = 100 A/μs		54	87	ns
Q <sub>rr</sub>	Reverse Recovery Charge			62	99	nC

Product parametric performance is indicated in the Electrical Characteristics for the listed test conditions, unless otherwise noted. Product performance may not be indicated by the Electrical Characteristics if operated under different conditions.

### THERMAL CHARACTERISTICS

Symbol	Parameter	Ratings	Units
R <sub>θJC</sub>	Thermal Resistance, Junction to Case (Top Source)	2.3	°C/W
R <sub>θJC</sub>	Thermal Resistance, Junction to Case (Bottom Drain)	1.0	
R <sub>θJA</sub>	Thermal Resistance, Junction to Ambient (Note 1a)	38	
R <sub>θJA</sub>	Thermal Resistance, Junction to Ambient (Note 1b)	81	
R <sub>θJA</sub>	Thermal Resistance, Junction to Ambient (Note 1c)	27	
R <sub>θJA</sub>	Thermal Resistance, Junction to Ambient (Note 1d)	34	
R <sub>θJA</sub>	Thermal Resistance, Junction to Ambient (Note 1e)	16	
R <sub>θJA</sub>	Thermal Resistance, Junction to Ambient (Note 1f)	19	
R <sub>θJA</sub>	Thermal Resistance, Junction to Ambient (Note 1g)	26	
R <sub>θJA</sub>	Thermal Resistance, Junction to Ambient (Note 1h)	61	
R <sub>θJA</sub>	Thermal Resistance, Junction to Ambient (Note 1i)	16	
R <sub>θJA</sub>	Thermal Resistance, Junction to Ambient (Note 1j)	23	
R <sub>θJA</sub>	Thermal Resistance, Junction to Ambient (Note 1k)	11	
R <sub>θJA</sub>	Thermal Resistance, Junction to Ambient (Note 1l)	13	

# FDMS86101DC

## NOTES:

1.  $R_{\theta JA}$  is determined with the device mounted on a FR-4 board using a specified pad of 2 oz copper as shown below.  $R_{\theta JC}$  is guaranteed by design while  $R_{\theta CA}$  is determined by the user's board design.

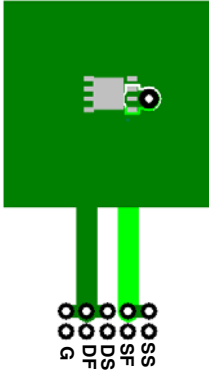

a) 38°C/W when mounted on a 1 in<sup>2</sup> pad of 2 oz copper.



b) 81°C/W when mounted on a minimum pad of 2 oz copper.

- c) Still air, 20.9×10.4×12.7 mm Aluminum Heat Sink, 1 in<sup>2</sup> pad of 2 oz copper
- d) Still air, 20.9×10.4×12.7 mm Aluminum Heat Sink, minimum pad of 2 oz copper
- e) Still air, 45.2×41.4×11.7 mm Aavid Thermalloy Part # 10-L41B-11 Heat Sink, 1 in<sup>2</sup> pad of 2 oz copper
- f) Still air, 45.2×41.4×11.7 mm Aavid Thermalloy Part # 10-L41B-11 Heat Sink, minimum pad of 2 oz copper
- g) .200FPM Airflow, No Heat Sink, 1 in<sup>2</sup> pad of 2 oz copper
- h) .200FPM Airflow, No Heat Sink, minimum pad of 2 oz copper
- i) .200FPM Airflow, 20.9×10.4×12.7 mm Aluminum Heat Sink, 1 in<sup>2</sup> pad of 2 oz copper
- j) .200FPM Airflow, 20.9×10.4×12.7 mm Aluminum Heat Sink, minimum pad of 2 oz copper
- k) .200FPM Airflow, 45.2×41.4×11.7 mm Aavid Thermalloy Part # 10-L41B-11 Heat Sink, 1 in<sup>2</sup> pad of 2 oz copper
- l) .200FPM Airflow, 45.2×41.4×11.7 mm Aavid Thermalloy Part # 10-L41B-11 Heat Sink, minimum pad of 2 oz copper

2. Pulse Test: Pulse Width < 300 μs, Duty cycle < 2.0%.
3. Starting  $T_J = 25^\circ\text{C}$ ; N-ch:  $L = 0.3\text{ mH}$ ,  $I_{AS} = 38\text{ A}$ ,  $V_{DD} = 90\text{ V}$ ,  $V_{GS} = 10\text{ V}$ .

## TYPICAL CHARACTERISTICS ( $T_J = 25^\circ\text{C}$ unless otherwise noted)

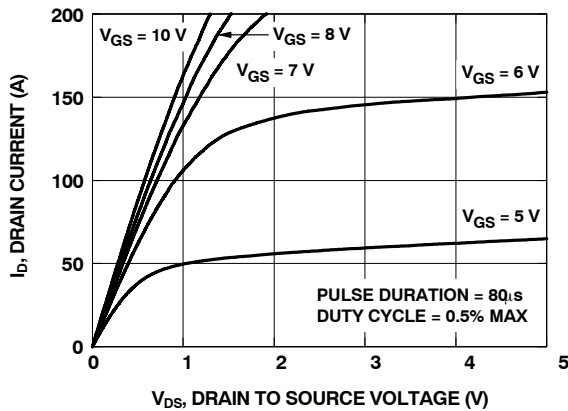

Figure 1. On Region Characteristics

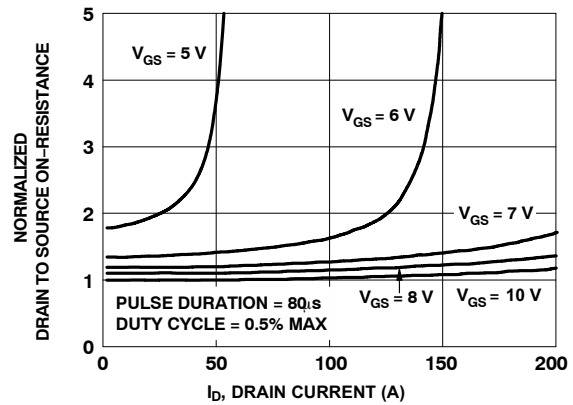

Figure 2. Normalized On-Resistance vs. Drain Current and Gate Voltage

TYPICAL CHARACTERISTICS ( $T_J = 25^\circ\text{C}$  unless otherwise noted)

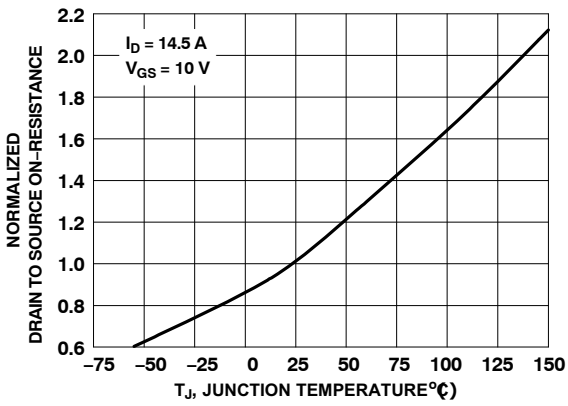

Figure 3. Normalized On Resistance vs. Junction Temperature

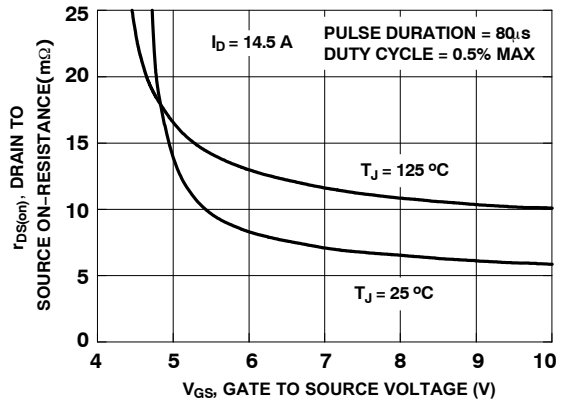

Figure 4. On-Resistance vs. Gate to Source Voltage

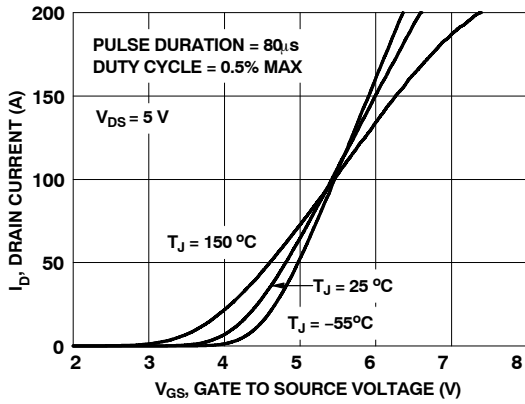

Figure 5. Transfer Characteristics

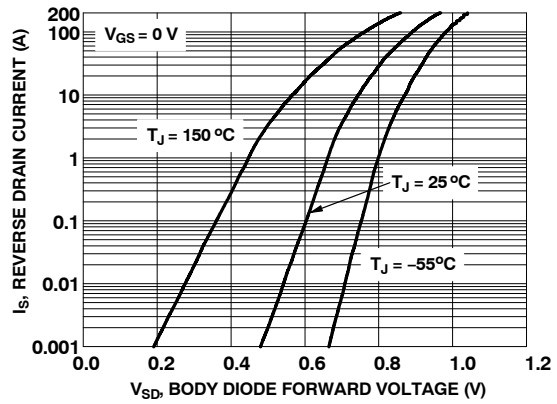

Figure 6. Source to Drain Diode Forward Voltage vs. Source Current

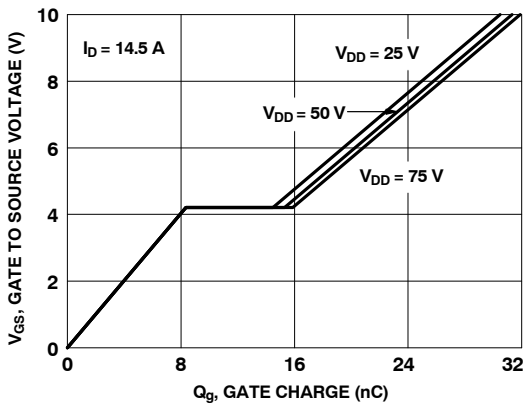

Figure 7. Gate Charge Characteristics

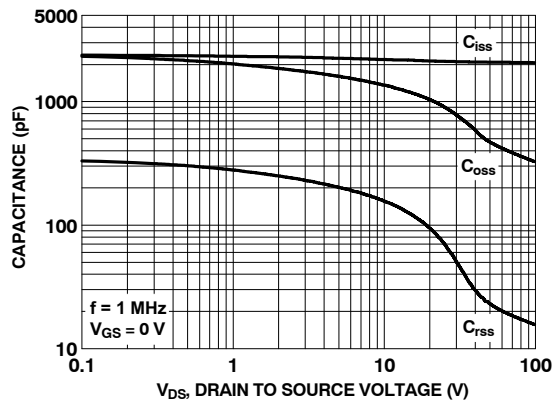

Figure 8. Capacitance vs. Drain to Source Voltage

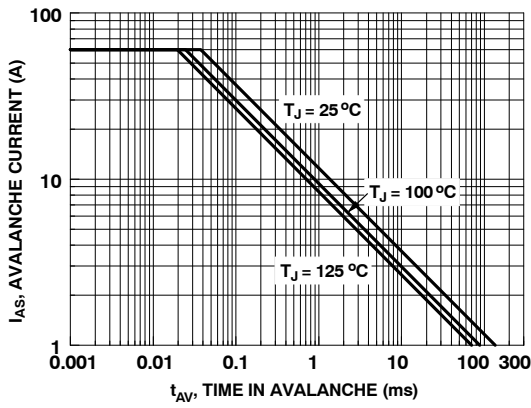

Figure 9. Unclamped Inductive Switching Capability

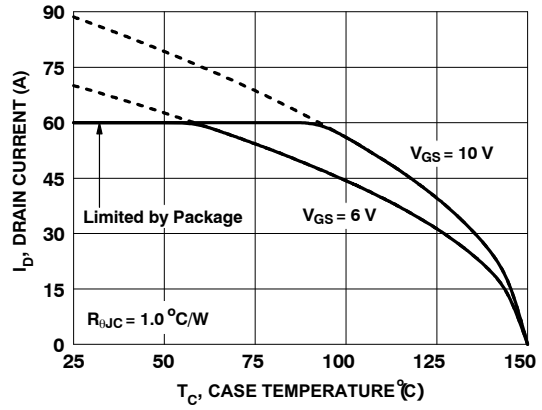

Figure 10. Maximum Continuous Drain Current vs. Case Temperature

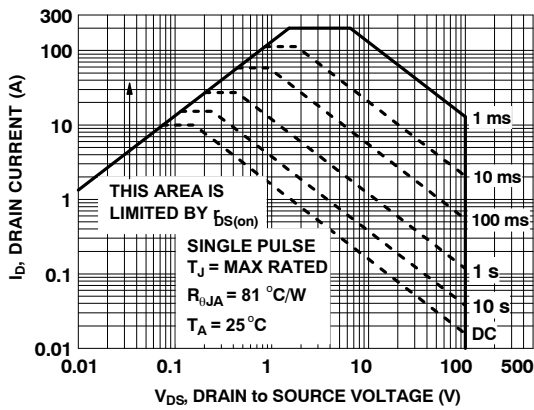

Figure 11. Forward Bias Safe Operating Area

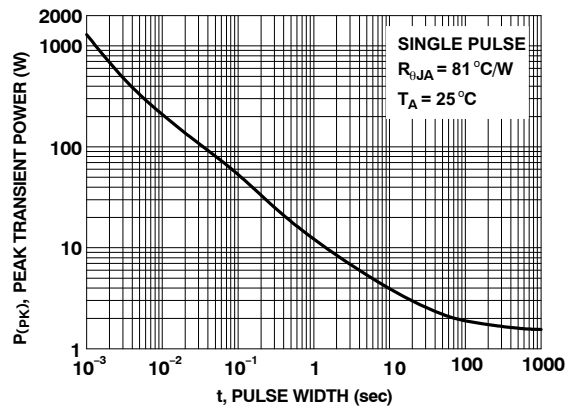

Figure 12. Single Pulse Maximum Power Dissipation

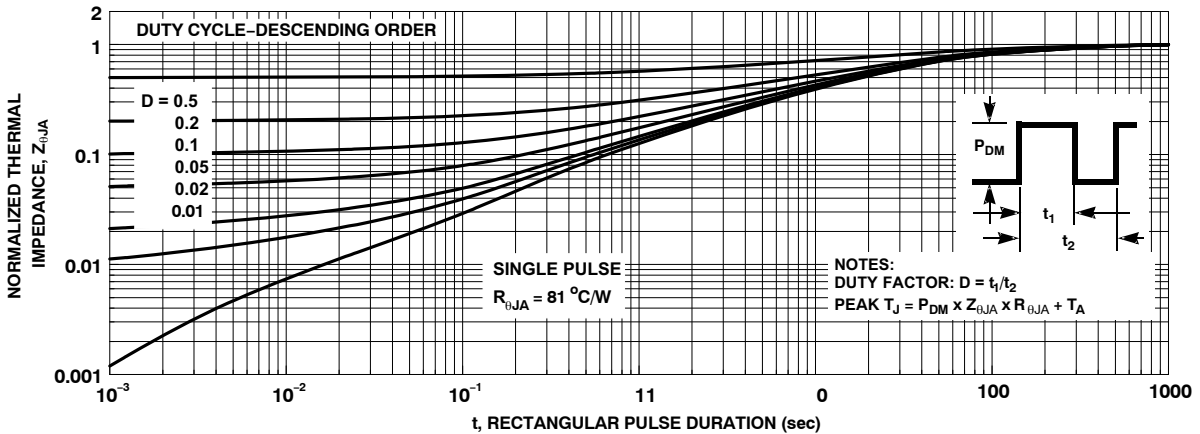

Figure 13. Junction-to-Case Transient Thermal Response Curve

POWERTRENCH and DUAL COOL are registered trademarks of Semiconductor Components Industries, LLC (SCILLC) or its subsidiaries in the United States and/or other countries.

# MECHANICAL CASE OUTLINE

## PACKAGE DIMENSIONS

ON Semiconductor®



### DFN8 5x6.15, 1.27P, DUAL COOL CASE 506EG ISSUE D

DATE 25 AUG 2020

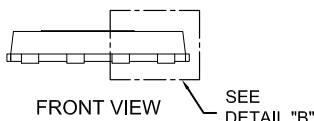
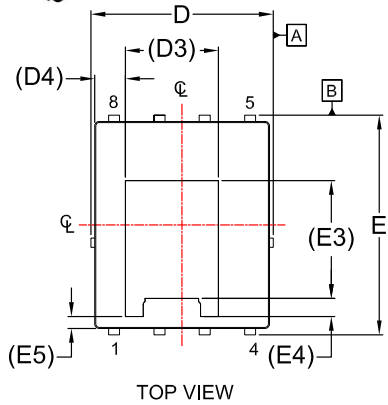
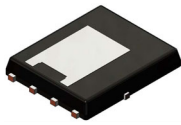

NOTES:

1. DIMENSIONING AND TOLERANCING PER ASME Y14.5M, 2009.
2. CONTROLLING DIMENSION: MILLIMETERS
3. COPLANARITY APPLIES TO THE EXPOSED PADS AS WELL AS THE TERMINALS.
4. DIMENSIONS D1 AND E1 DO NOT INCLUDE MOLD FLASH, PROTRUSIONS, OR GATE BURRS.
5. SEATING PLANE IS DEFINED BY THE TERMINALS. "A1" IS DEFINED AS THE DISTANCE FROM THE SEATING PLANE TO THE LOWEST POINT ON THE PACKAGE BODY.

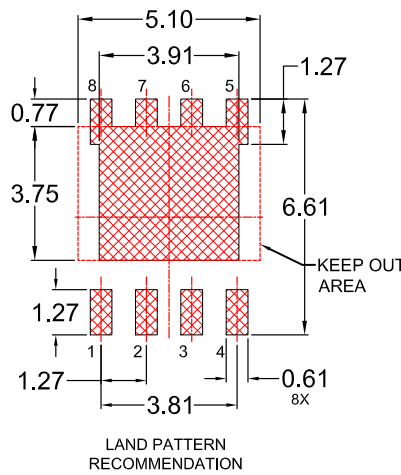
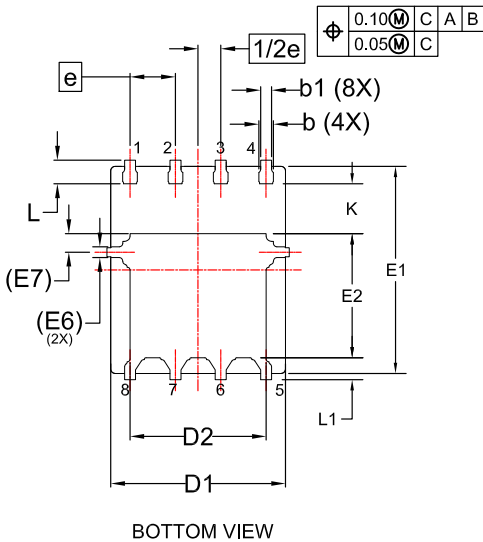
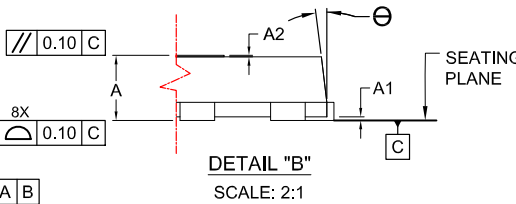

\*FOR ADDITIONAL INFORMATION ON OUR PB-FREE STRATEGY AND SOLDERING DETAILS, PLEASE DOWNLOAD THE ON SEMICONDUCTOR SOLDERING AND MOUNTING TECHNIQUES REFERENCE MANUAL, SOLDERRM/D.

DIM	MILLIMETERS		
	MIN.	NOM.	MAX.
A	0.85	0.90	0.95
A1	-	-	0.05
A2	-	-	0.05
b	0.31	0.41	0.51
b1	0.21	0.31	0.41
c	0.20	0.25	0.30
D	4.90	5.00	5.10
D1	4.80	4.90	5.00
D2	3.67	3.82	3.97
D3	2.60 REF		
D4	0.86 REF		
E	6.05	6.15	6.25
E1	5.70	5.80	5.90
E2	3.38	3.48	3.58
E3	3.30 REF		
E4	0.50 REF		
E5	0.34 REF		
E6	0.30 REF		
E7	0.52 REF		
e	1.27 BSC		
1/2e	0.635 BSC		
K	1.30	1.40	1.50
L	0.56	0.66	0.76
L1	0.52	0.62	0.72
θ	0°	---	12°

### GENERIC MARKING DIAGRAM\*

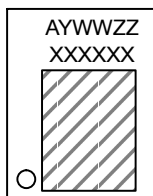

XXXX = Specific Device Code  
 A = Assembly Location  
 Y = Year  
 WW = Work Week  
 ZZ = Assembly Lot Code

\*This information is generic. Please refer to device data sheet for actual part marking. Pb-Free indicator, "G" or microdot "•", may or may not be present. Some products may not follow the Generic Marking.

<b>DOCUMENT NUMBER:</b>	<b>98AON84257G</b>	Electronic versions are uncontrolled except when accessed directly from the Document Repository. Printed versions are uncontrolled except when stamped "CONTROLLED COPY" in red.
<b>DESCRIPTION:</b>	<b>DFN8 5x6.15, 1.27P, DUAL COOL</b>	<b>PAGE 1 OF 1</b>

ON Semiconductor and ON are trademarks of Semiconductor Components Industries, LLC dba ON Semiconductor or its subsidiaries in the United States and/or other countries. ON Semiconductor reserves the right to make changes without further notice to any products herein. ON Semiconductor makes no warranty, representation or guarantee regarding the suitability of its products for any particular purpose, nor does ON Semiconductor assume any liability arising out of the application or use of any product or circuit, and specifically disclaims any and all liability, including without limitation special, consequential or incidental damages. ON Semiconductor does not convey any license under its patent rights nor the rights of others.

**onsemi**, **Onsemi**, and other names, marks, and brands are registered and/or common law trademarks of Semiconductor Components Industries, LLC dba "**onsemi**" or its affiliates and/or subsidiaries in the United States and/or other countries. **onsemi** owns the rights to a number of patents, trademarks, copyrights, trade secrets, and other intellectual property. A listing of **onsemi**'s product/patent coverage may be accessed at [www.onsemi.com/site/pdf/Patent-Marking.pdf](http://www.onsemi.com/site/pdf/Patent-Marking.pdf). **onsemi** reserves the right to make changes at any time to any products or information herein, without notice. The information herein is provided "as-is" and **onsemi** makes no warranty, representation or guarantee regarding the accuracy of the information, product features, availability, functionality, or suitability of its products for any particular purpose, nor does **onsemi** assume any liability arising out of the application or use of any product or circuit, and specifically disclaims any and all liability, including without limitation special, consequential or incidental damages. Buyer is responsible for its products and applications using **onsemi** products, including compliance with all laws, regulations and safety requirements or standards, regardless of any support or applications information provided by **onsemi**. "Typical" parameters which may be provided in **onsemi** data sheets and/or specifications can and do vary in different applications and actual performance may vary over time. All operating parameters, including "Typicals" must be validated for each customer application by customer's technical experts. **onsemi** does not convey any license under any of its intellectual property rights nor the rights of others. **onsemi** products are not designed, intended, or authorized for use as a critical component in life support systems or any FDA Class 3 medical devices or medical devices with a same or similar classification in a foreign jurisdiction or any devices intended for implantation in the human body. Should Buyer purchase or use **onsemi** products for any such unintended or unauthorized application, Buyer shall indemnify and hold **onsemi** and its officers, employees, subsidiaries, affiliates, and distributors harmless against all claims, costs, damages, and expenses, and reasonable attorney fees arising out of, directly or indirectly, any claim of personal injury or death associated with such unintended or unauthorized use, even if such claim alleges that **onsemi** was negligent regarding the design or manufacture of the part. **onsemi** is an Equal Opportunity/Affirmative Action Employer. This literature is subject to all applicable copyright laws and is not for resale in any manner.

## PUBLICATION ORDERING INFORMATION

### LITERATURE FULFILLMENT:

Email Requests to: [orderlit@onsemi.com](mailto:orderlit@onsemi.com)

**onsemi Website:** [www.onsemi.com](http://www.onsemi.com)

### TECHNICAL SUPPORT

**North American Technical Support:**

Voice Mail: 1 800-282-9855 Toll Free USA/Canada

Phone: 011 421 33 790 2910

**Europe, Middle East and Africa Technical Support:**

Phone: 00421 33 790 2910

For additional information, please contact your local Sales Representative



## X-ON Electronics

Largest Supplier of Electrical and Electronic Components

*Click to view similar products for [MOSFET](#) category:*

*Click to view products by [ON Semiconductor](#) manufacturer:*

Other Similar products are found below :

[614233C](#) [648584F](#) [IRFD120](#) [JANTX2N5237](#) [FCA20N60\\_F109](#) [FDZ595PZ](#) [2SK2545\(Q,T\)](#) [405094E](#) [423220D](#) [TPCC8103,L1Q\(CM](#)  
[MIC4420CM-TR](#) [VN1206L](#) [SBVS138LT1G](#) [614234A](#) [715780A](#) [NTNS3166NZT5G](#) [SSM6J414TU,LF\(T](#) [751625C](#) [BUK954R8-60E](#)  
[NTE6400](#) [SQJ402EP-T1-GE3](#) [2SK2614\(TE16L1,Q\)](#) [2N7002KW-FAI](#) [DMN1017UCP3-7](#) [EFC2J004NUZTDG](#) [ECH8691-TL-W](#)  
[FCAB21350L1](#) [P85W28HP2F-7071](#) [DMN1053UCP4-7](#) [NTE221](#) [NTE2384](#) [NTE2903](#) [NTE2941](#) [NTE2945](#) [NTE2946](#) [NTE2960](#) [NTE2967](#)  
[NTE2969](#) [NTE2976](#) [NTE455](#) [NTE6400A](#) [NTE2910](#) [NTE2916](#) [NTE2956](#) [NTE2911](#) [DMN2080UCB4-7](#) [TK10A80W,S4X\(S](#)  
[SSM6P69NU,LF](#) [DMP22D4UFO-7B](#) [DMN1006UCA6-7](#)