

STEALTH™ Diode

50 A, 600 V

FFH50US60S

Description

The FFH50US60S is a STEALTH™ diode optimized for low loss performance in output rectification. The STEALTH family exhibits low reverse recovery current (I_{RR}), low V_F and soft recovery under typical operating conditions. This device is intended for use as an output rectification diode in Telecom power supplies and other power switching applications. Lower V_F and I_{RR} reduces diode losses.

Features

- Stealth Recovery, $t_{rr} = 113$ ns (@ $I_F = 50$ A)
- Max Forward Voltage, $V_F = 1.54$ V (@ $T_C = 25^\circ\text{C}$)
- 600 V Reverse Voltage and High Reliability
- Operating Temperature = 175°C
- Avalanche Energy Rated
- This Device is Pb-Free and is RoHS Compliant

Applications

- SMPS, Welders
- Power Factor Correction
- Uninterruptible Power Supplies
- Motor Drives

ABSOLUTE MAXIMUM RATINGS ($T_C = 25^\circ\text{C}$ unless otherwise noted)

Rating	Symbol	Value	Unit
Repetitive Peak Reverse Voltage	V_{RRM}	600	V
Working Peak Reverse Voltage	V_{RWM}	600	V
DC Blocking Voltage	V_R	600	V
Average Rectified Forward Current ($T_C = 120^\circ\text{C}$)	$I_{F(AV)}$	50	A
Repetitive Peak Surge Current (20 kHz Square Wave)	I_{FRM}	100	A
Nonrepetitive Peak Surge Current (Halfwave, 1 Phase, 60 Hz)	I_{FSM}	500	A
Power Dissipation	P_D	200	W
Avalanche Energy (1 A, 40 mH)	E_{AVL}	20	mJ
Operating and Storage Temperature Range	T_J, T_{STG}	-55 to 175	$^\circ\text{C}$
Maximum Temperature for Soldering Leads at 0.063 in (1.6 mm) from Case for 10 s	T_L	300	$^\circ\text{C}$
Maximum Temperature for Soldering Package Body for 10 s	T_{PKG}	260	$^\circ\text{C}$

Stresses exceeding those listed in the Maximum Ratings table may damage the device. If any of these limits are exceeded, device functionality should not be assumed, damage may occur and reliability may be affected.



ON Semiconductor®

www.onsemi.com

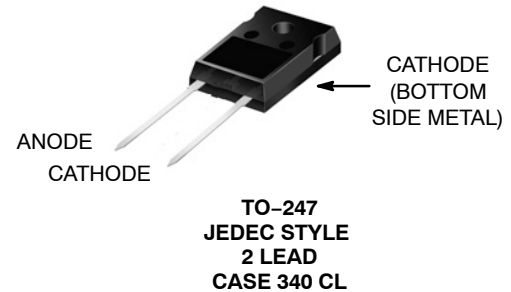

MARKING DIAGRAM

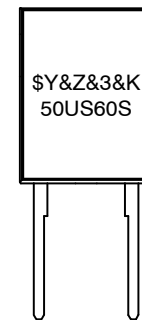

\$Y = ON Semiconductor Logo
 &Z = Assembly Plant Code
 &3 = Numeric Date Code
 &K = Lot Code
 50US60S = Specific Device Code



ORDERING INFORMATION

See detailed ordering and shipping information on page 2 of this data sheet.

FFH50US60S

PACKAGE MARKING AND ORDERING INFORMATION

Device Marking	Device	Package	Packing Methode	Reel Size	Tape Width	Quantity
FFH50US60S	FFH50US60S	TO247-2L	Tube	N/A	N/A	30

ELECTRICAL CHARACTERISTICS (T_C = 25°C unless otherwise noted)

Symbol	Parameter	Test Conditions	Min.	Typ.	Max.	Unit
--------	-----------	-----------------	------	------	------	------

OFF STATE CHARACTERISTICS

I _R	Instantaneous Reverse Current	V _R = 600 V	T _C = 25°C	-	-	100	μA
			T _C = 125°C	-	-	1	mA

ON CHARACTERISTICS

V _F	Instantaneous Forward Voltage	I _F = 50 A	T _C = 25°C	-	1.38	1.54	V
			T _C = 125°C	-	1.37	1.53	V

DYNAMIC CHARACTERISTICS

C _J	Junction Capacitance	V _R = 10 V, I _F = 0 A	-	110	-	pF
----------------	----------------------	---	---	-----	---	----

SWITCHING CHARACTERISTICS

T _{rr}	Reverse Recovery Time	I _F = 1 A, di _F /dt = 100 A/μs, V _R = 15 V	-	47	80	ns
			I _F = 50 A, di _F /dt = 100 A/μs, V _R = 15 V	-	75	124
T _{rr}	Reverse Recovery Time	I _F = 50 A, di _F /dt = 200 A/μs, V _R = 390 V, T _C = 25°C	-	113	-	ns
I _{RR}	Reverse Recovery Current		-	9.6	-	A
Q _{RR}	Reverse Recovered Charge		-	0.9	-	μC
T _{rr}	Reverse Recovery Time		I _F = 50 A, di _F /dt = 200 A/μs, V _R = 390 V, T _C = 125°C	-	235	-
S	Softness Factor (t _p /t _a)	I _F = 50 A, di _F /dt = 200 A/μs, V _R = 390 V, T _C = 125°C	-	1.5	-	-
I _{RR}	Reverse Recovery Current		-	15	-	A
Q _{RR}	Reverse Recovered Charge		-	2.3	-	μC
T _{rr}	Reverse Recovery Time		I _F = 50 A, di _F /dt = 1000 A/μs, V _R = 390 V, T _C = 125°C	-	110	-
S	Softness Factor (t _p /t _a)	-		0.8	-	-
I _{RR}	Reverse Recovery Current	-		46	-	A
Q _{RR}	Reverse Recovered Charge	-		3.1	-	μC
di _M /dt	Maximum di/dt during t _p		-	1000	-	A/μs

THERMAL CHARACTERISTICS

R _{θJC}	Thermal Resistance Junction to Case		-	-	0.75	°C/W
R _{θJA}	Thermal Resistance Junction to Ambient	TO-247	-	-	30	°C/W

Product parametric performance is indicated in the Electrical Characteristics for the listed test conditions, unless otherwise noted. Product performance may not be indicated by the Electrical Characteristics if operated under different conditions.

FFH50US60S

TYPICAL PERFORMANCE CURVES

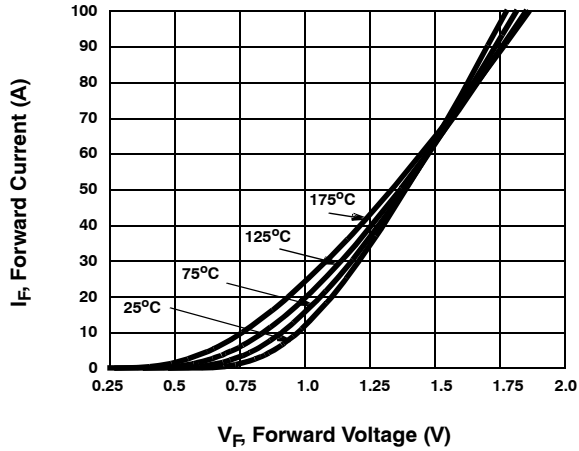

Figure 1. Forward Current vs. Forward Voltage

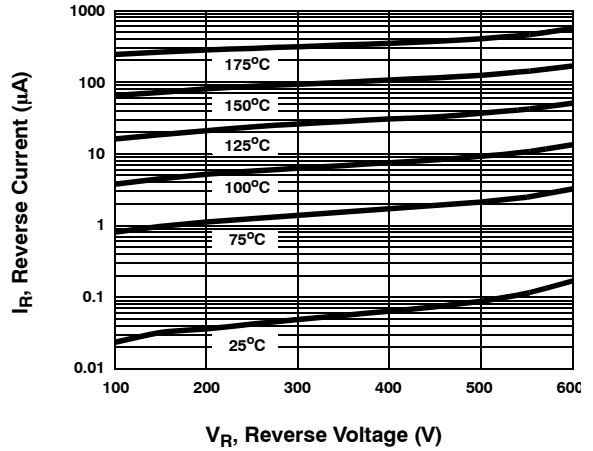

Figure 2. Reverse Current vs. Reverse Voltage

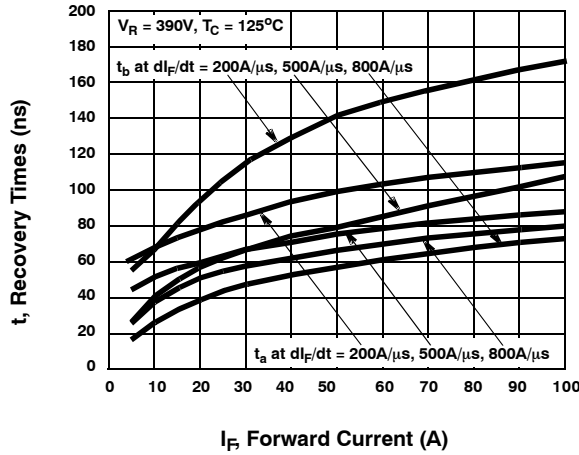

Figure 3. t_a and t_b Curves vs. Forward Current

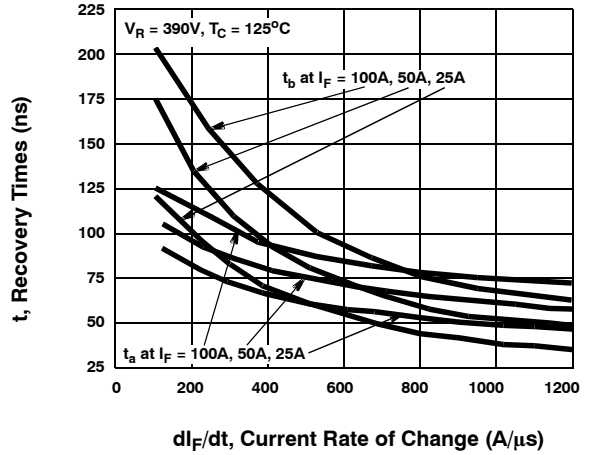

Figure 4. t_a and t_b Curves vs. di_F/dt

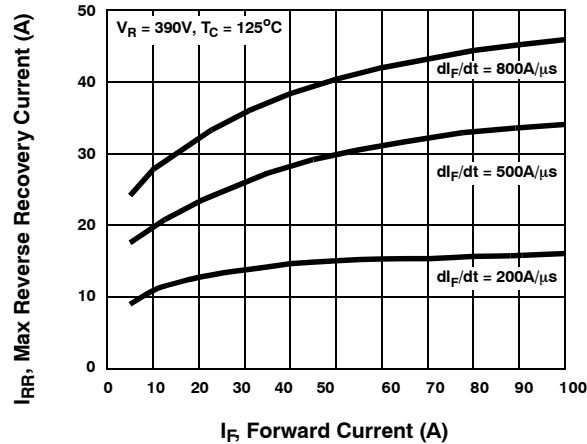

Figure 5. Maximum Reverse Recovery Current vs. Forward Current

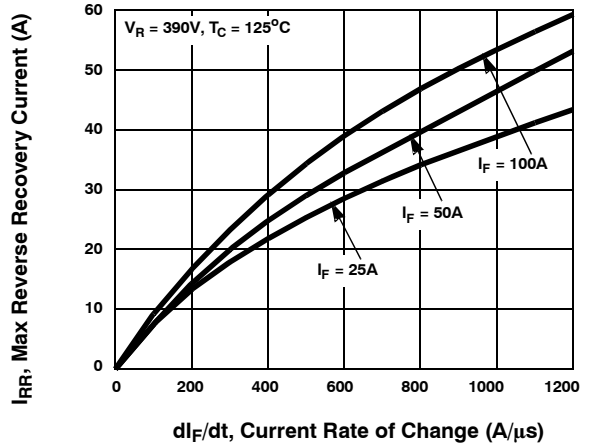

Figure 6. Maximum Reverse Recovery Current vs. di_F/dt

FFH50US60S

TYPICAL PERFORMANCE CURVES

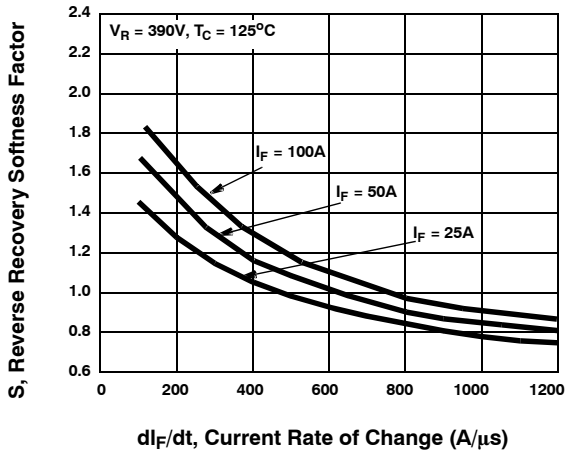

Figure 7. Reverse Recovery Softness Factor vs. di_F/dt

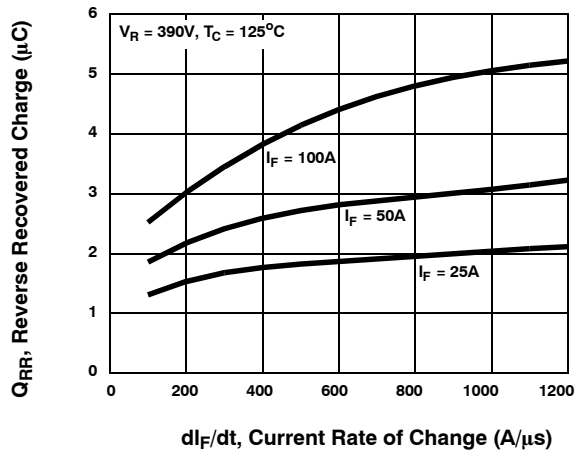

Figure 8. Reverse Recovery Charge vs. di_F/dt

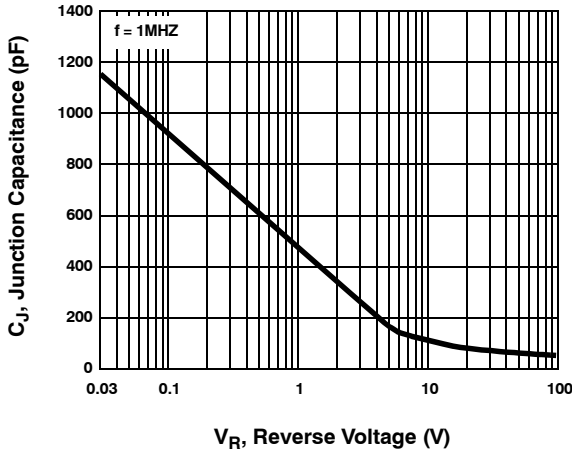

Figure 9. Junction Capacitance vs. Reverse Voltage

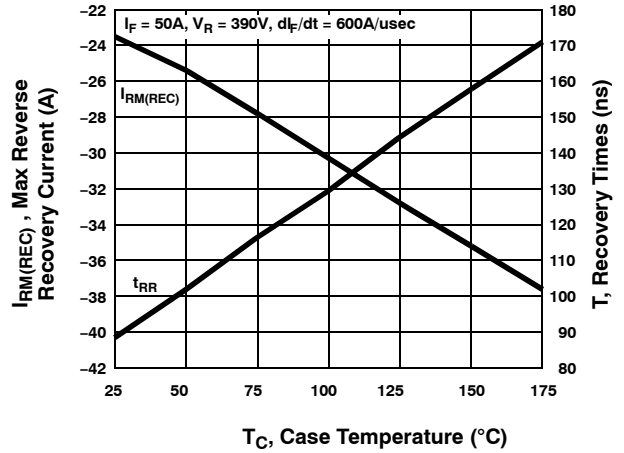

Figure 10. Maximum Reverse Recovery Current and t_{RR} vs. Case Temperature

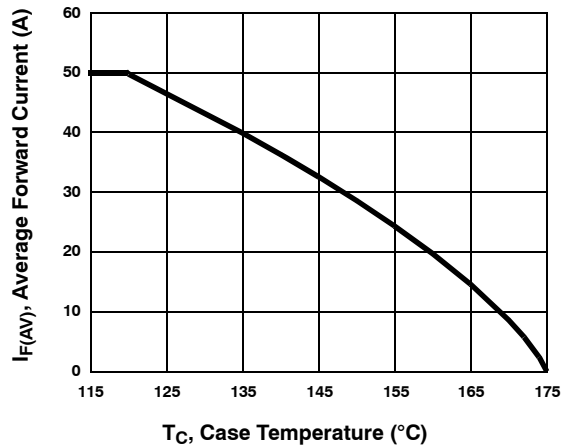

Figure 11. DC Current Derating Curve

TYPICAL PERFORMANCE CURVES

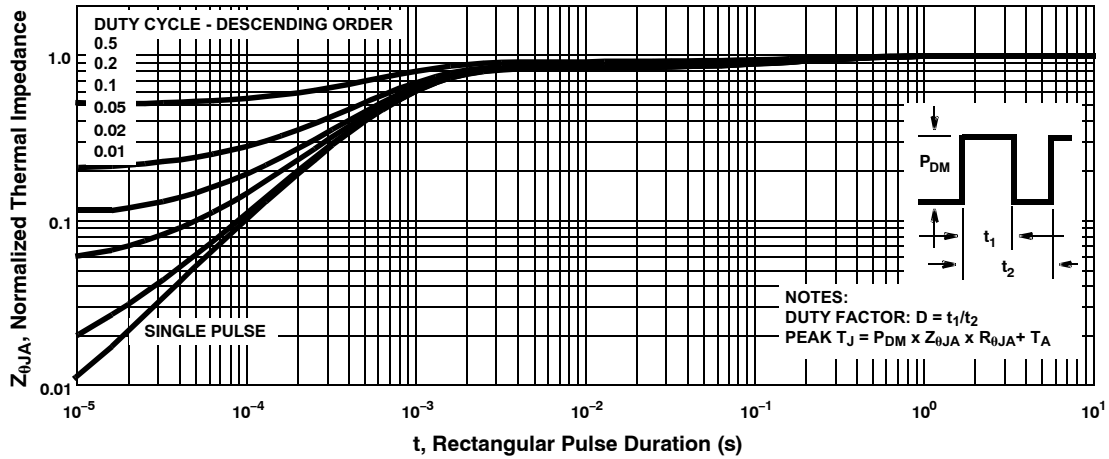

Figure 12. Normalized Maximum Transient Thermal Impedance

TEST CIRCUITS AND WAVEFORMS

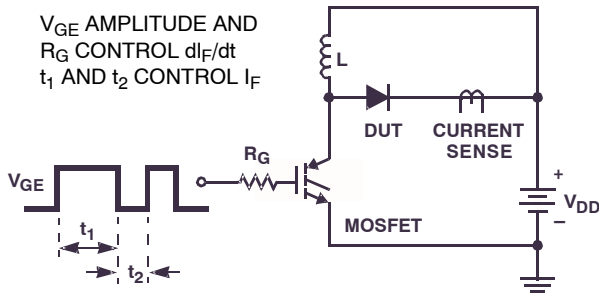

Figure 13. T_{rr} Test Circuit

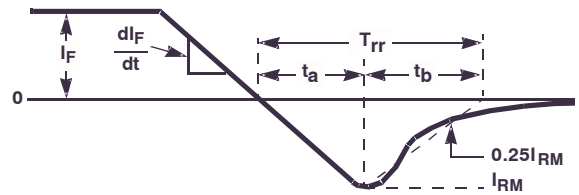

Figure 14. T_{rr} Waveforms and Definitions

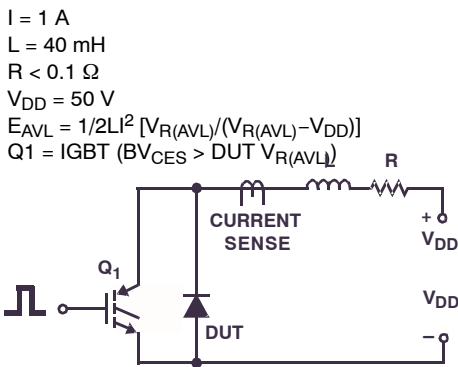

Figure 15. Avalanche Energy Test Circuit

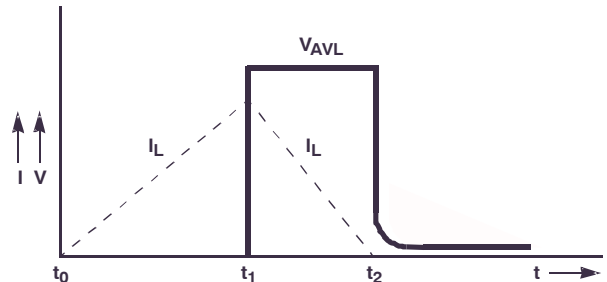

Figure 16. Avalanche Current and Voltage Waveforms

MECHANICAL CASE OUTLINE

PACKAGE DIMENSIONS

ON Semiconductor®



TO-247-2LD
CASE 340CL
ISSUE A

DATE 03 DEC 2019

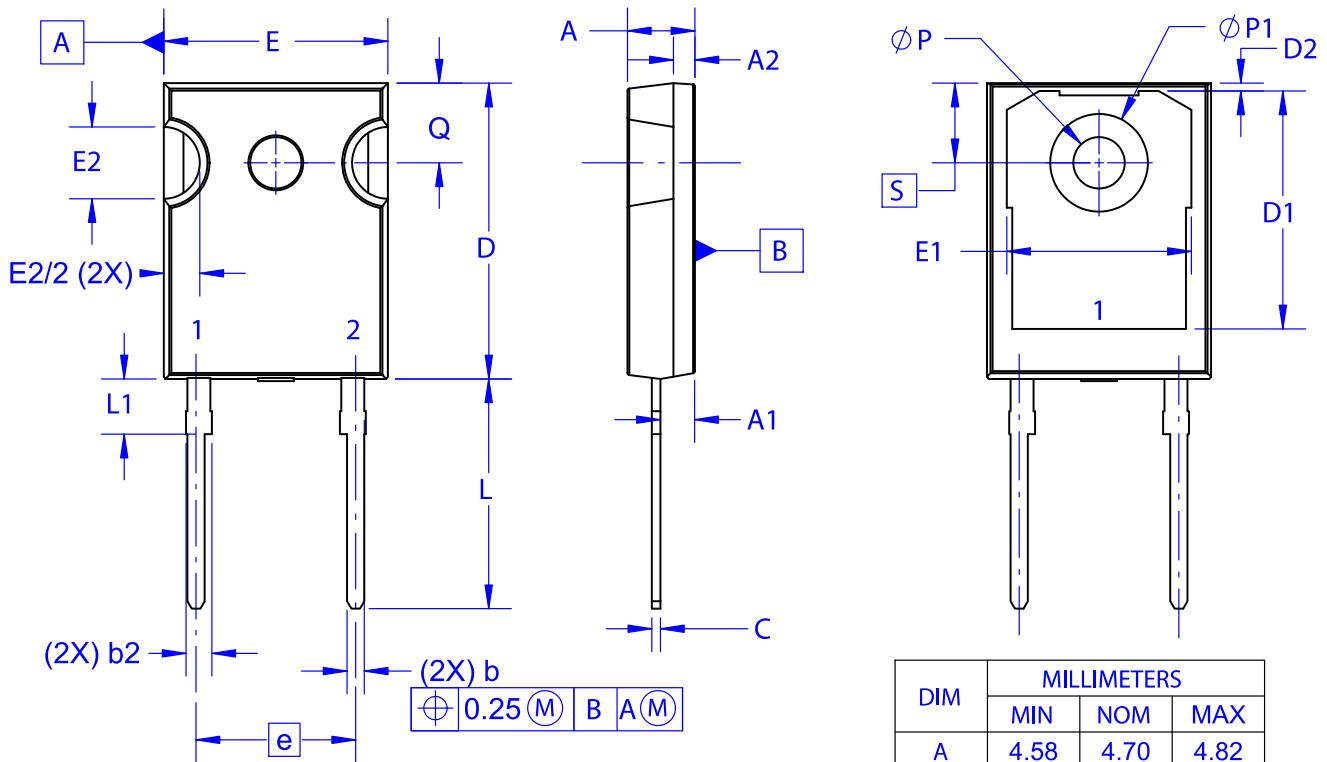

⊕ 0.25 (M) B A (M)

NOTES: UNLESS OTHERWISE SPECIFIED.

- A. DIMENSIONS ARE EXCLUSIVE OF BURRS, MOLD FLASH, AND TIE BAR EXTRUSIONS.
- B. ALL DIMENSIONS ARE IN MILLIMETERS.
- C. DRAWING CONFORMS TO ASME Y14.5 - 2009.
- D. DIMENSION A1 TO BE MEASURED IN THE REGION DEFINED BY L1.
- E. LEAD FINISH IS UNCONTROLLED IN THE REGION DEFINED BY L1.

GENERIC MARKING DIAGRAM*



XXXX = Specific Device Code
A = Assembly Location
Y = Year
WW = Work Week
ZZ = Assembly Lot Code

*This information is generic. Please refer to device data sheet for actual part marking. Pb-Free indicator, "G" or microdot "•", may or may not be present. Some products may not follow the Generic Marking.

DIM	MILLIMETERS		
	MIN	NOM	MAX
A	4.58	4.70	4.82
A1	2.29	2.40	2.66
A2	1.30	1.50	1.70
b	1.17	1.26	1.35
b2	1.53	1.65	1.77
c	0.51	0.61	0.71
D	20.32	20.57	20.82
D1	16.37	16.57	16.77
D2	0.51	0.93	1.35
E	15.37	15.62	15.87
E1	12.81	~	~
E2	4.96	5.08	5.20
e	~	11.12	~
L	15.75	16.00	16.25
L1	3.69	3.81	3.93
∅P	3.51	3.58	3.65
∅P1	6.61	6.73	6.85
Q	5.34	5.46	5.58
S	5.34	5.46	5.58

DOCUMENT NUMBER:	98AON13850G	Electronic versions are uncontrolled except when accessed directly from the Document Repository. Printed versions are uncontrolled except when stamped "CONTROLLED COPY" in red.
DESCRIPTION:	TO-247-2LD	PAGE 1 OF 1

ON Semiconductor and are trademarks of Semiconductor Components Industries, LLC dba ON Semiconductor or its subsidiaries in the United States and/or other countries. ON Semiconductor reserves the right to make changes without further notice to any products herein. ON Semiconductor makes no warranty, representation or guarantee regarding the suitability of its products for any particular purpose, nor does ON Semiconductor assume any liability arising out of the application or use of any product or circuit, and specifically disclaims any and all liability, including without limitation special, consequential or incidental damages. ON Semiconductor does not convey any license under its patent rights nor the rights of others.

onsemi, **Onsemi**, and other names, marks, and brands are registered and/or common law trademarks of Semiconductor Components Industries, LLC dba "**onsemi**" or its affiliates and/or subsidiaries in the United States and/or other countries. **onsemi** owns the rights to a number of patents, trademarks, copyrights, trade secrets, and other intellectual property. A listing of **onsemi**'s product/patent coverage may be accessed at www.onsemi.com/site/pdf/Patent-Marking.pdf. **onsemi** reserves the right to make changes at any time to any products or information herein, without notice. The information herein is provided "as-is" and **onsemi** makes no warranty, representation or guarantee regarding the accuracy of the information, product features, availability, functionality, or suitability of its products for any particular purpose, nor does **onsemi** assume any liability arising out of the application or use of any product or circuit, and specifically disclaims any and all liability, including without limitation special, consequential or incidental damages. Buyer is responsible for its products and applications using **onsemi** products, including compliance with all laws, regulations and safety requirements or standards, regardless of any support or applications information provided by **onsemi**. "Typical" parameters which may be provided in **onsemi** data sheets and/or specifications can and do vary in different applications and actual performance may vary over time. All operating parameters, including "Typicals" must be validated for each customer application by customer's technical experts. **onsemi** does not convey any license under any of its intellectual property rights nor the rights of others. **onsemi** products are not designed, intended, or authorized for use as a critical component in life support systems or any FDA Class 3 medical devices or medical devices with a same or similar classification in a foreign jurisdiction or any devices intended for implantation in the human body. Should Buyer purchase or use **onsemi** products for any such unintended or unauthorized application, Buyer shall indemnify and hold **onsemi** and its officers, employees, subsidiaries, affiliates, and distributors harmless against all claims, costs, damages, and expenses, and reasonable attorney fees arising out of, directly or indirectly, any claim of personal injury or death associated with such unintended or unauthorized use, even if such claim alleges that **onsemi** was negligent regarding the design or manufacture of the part. **onsemi** is an Equal Opportunity/Affirmative Action Employer. This literature is subject to all applicable copyright laws and is not for resale in any manner.

PUBLICATION ORDERING INFORMATION

LITERATURE FULFILLMENT:

Email Requests to: orderlit@onsemi.com

onsemi Website: www.onsemi.com

TECHNICAL SUPPORT

North American Technical Support:

Voice Mail: 1 800-282-9855 Toll Free USA/Canada

Phone: 011 421 33 790 2910

Europe, Middle East and Africa Technical Support:

Phone: 00421 33 790 2910

For additional information, please contact your local Sales Representative

X-ON Electronics

Largest Supplier of Electrical and Electronic Components

Click to view similar products for [Diodes - General Purpose, Power, Switching category:](#)

Click to view products by [ON Semiconductor manufacturer:](#)

Other Similar products are found below :

[RD0306T-H](#) [BAV17-TR](#) [BAV19-TR](#) [1N3611](#) [NTE156A](#) [NTE525](#) [NTE571](#) [NTE574](#) [NTE5804](#) [NTE5806](#) [NTE6244](#) [1SS181-TP](#)
[1SS193,LF](#) [1SS400CST2RA](#) [SDAA13](#) [SHN2D02FUTW1T1G](#) [LS4151GS08](#) [1N4449](#) [1N456A](#) [1N4934-E3/73](#) [1N914B](#) [1N914BTR](#)
[RFUH20TB3S](#) [BAS 28 E6327](#) [BAV199-TP](#) [BAW56DWQ-7-F](#) [BAW75-TAP](#) [MM230L-CAA](#) [IDW40E65D1](#) [JAN1N3600](#) [LL4151-GS18](#)
[053684A](#) [SMMSD4148T3G](#) [707803H](#) [NSVDAN222T1G](#) [SP000010217](#) [ACDSW4448-HF](#) [CDSZC01100-HF](#) [BAV199E6433HTMA1](#)
[BAV70M3T5G](#) [SMBT2001T1G](#) [NTE5801](#) [NTE5800](#) [NTE5808](#) [NTE6240](#) [NTE6248](#) [DLM10C-AT1](#) [BAS28-7](#) [BAW56HDW-13](#) [BAS28](#)
[TR](#)