

# ON Semiconductor

## Is Now

The logo for onsemi, featuring the word "onsemi" in a dark teal, lowercase, sans-serif font. The letter "i" is stylized with a white dot and a teal vertical bar. A small orange triangle is positioned above the top right of the "i". A trademark symbol (TM) is located to the right of the logo.

To learn more about onsemi™, please visit our website at  
[www.onsemi.com](http://www.onsemi.com)

---

**onsemi** and **onsemi** and other names, marks, and brands are registered and/or common law trademarks of Semiconductor Components Industries, LLC dba "**onsemi**" or its affiliates and/or subsidiaries in the United States and/or other countries. **onsemi** owns the rights to a number of patents, trademarks, copyrights, trade secrets, and other intellectual property. A listing of **onsemi** product/patent coverage may be accessed at [www.onsemi.com/site/pdf/Patent-Marking.pdf](http://www.onsemi.com/site/pdf/Patent-Marking.pdf). **onsemi** reserves the right to make changes at any time to any products or information herein, without notice. The information herein is provided "as-is" and **onsemi** makes no warranty, representation or guarantee regarding the accuracy of the information, product features, availability, functionality, or suitability of its products for any particular purpose, nor does **onsemi** assume any liability arising out of the application or use of any product or circuit, and specifically disclaims any and all liability, including without limitation special, consequential or incidental damages. Buyer is responsible for its products and applications using **onsemi** products, including compliance with all laws, regulations and safety requirements or standards, regardless of any support or applications information provided by **onsemi**. "Typical" parameters which may be provided in **onsemi** data sheets and/or specifications can and do vary in different applications and actual performance may vary over time. All operating parameters, including "Typicals" must be validated for each customer application by customer's technical experts. **onsemi** does not convey any license under any of its intellectual property rights nor the rights of others. **onsemi** products are not designed, intended, or authorized for use as a critical component in life support systems or any FDA Class 3 medical devices or medical devices with a same or similar classification in a foreign jurisdiction or any devices intended for implantation in the human body. Should Buyer purchase or use **onsemi** products for any such unintended or unauthorized application, Buyer shall indemnify and hold **onsemi** and its officers, employees, subsidiaries, affiliates, and distributors harmless against all claims, costs, damages, and expenses, and reasonable attorney fees arising out of, directly or indirectly, any claim of personal injury or death associated with such unintended or unauthorized use, even if such claim alleges that **onsemi** was negligent regarding the design or manufacture of the part. **onsemi** is an Equal Opportunity/Affirmative Action Employer. This literature is subject to all applicable copyright laws and is not for resale in any manner. Other names and brands may be claimed as the property of others.



ON Semiconductor®

# FGA25N120ANTDTU

## 1200 V, 25 A NPT Trench IGBT

### Features

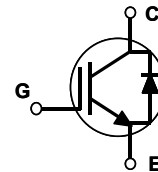
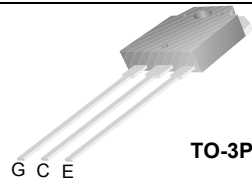
- NPT Trench Technology, Positive Temperature Coefficient
- Low Saturation Voltage:  $V_{CE(sat), typ} = 2.0\text{ V}$   
@  $I_C = 25\text{ A}$  and  $T_C = 25^\circ\text{C}$
- Low Switching Loss:  $E_{off, typ} = 0.96\text{ mJ}$   
@  $I_C = 25\text{ A}$  and  $T_C = 25^\circ\text{C}$
- Extremely Enhanced Avalanche Capability

### Description

Using ON Semiconductor's proprietary trench design and advanced NPT technology, the 1200V NPT IGBT offers superior conduction and switching performances, high avalanche ruggedness and easy parallel operation. This device is well suited for the resonant or soft switching application such as induction heating, microwave oven.

### Applications

- Induction Heating, Microwave Oven



### Absolute Maximum Ratings

Symbol	Description		Ratings	Unit
$V_{CES}$	Collector-Emitter Voltage		1200	V
$V_{GES}$	Gate-Emitter Voltage		$\pm 20$	V
$I_C$	Collector Current	@ $T_C = 25^\circ\text{C}$	50	A
	Collector Current	@ $T_C = 100^\circ\text{C}$	25	A
$I_{CM(1)}$	Pulsed Collector Current		90	A
$I_F$	Diode Continuous Forward Current	@ $T_C = 25^\circ\text{C}$	50	A
	Diode Continuous Forward Current	@ $T_C = 100^\circ\text{C}$	25	A
$I_{FM}$	Diode Maximum Forward Current		150	A
$P_D$	Maximum Power Dissipation	@ $T_C = 25^\circ\text{C}$	312	W
	Maximum Power Dissipation	@ $T_C = 100^\circ\text{C}$	125	W
$T_J$	Operating Junction Temperature		-55 to +150	$^\circ\text{C}$
$T_{stg}$	Storage Temperature Range		-55 to +150	$^\circ\text{C}$
$T_L$	Maximum Lead Temp. for soldering Purposes, 1/8" from case for 5 seconds		300	$^\circ\text{C}$

**Notes:**

(1) Repetitive rating: Pulse width limited by max. junction temperature

### Thermal Characteristics

Symbol	Parameter	Typ.	Max.	Unit
$R_{\theta JC}(\text{IGBT})$	Thermal Resistance, Junction-to-Case	--	0.4	$^\circ\text{C}/\text{W}$
$R_{\theta JC}(\text{DIODE})$	Thermal Resistance, Junction-to-Case	--	2.0	$^\circ\text{C}/\text{W}$
$R_{\theta JA}$	Thermal Resistance, Junction-to-Ambient	--	40	$^\circ\text{C}/\text{W}$

## Package Marking and Ordering Information

Part Number	Top Mark	Package	Packing Method	Reel Size	Tape Width	Quantity
FGA25N120ANTDTU-F109	FGA25N120ANTDTU	TO-3PN	Tube	N/A	N/A	30

## Electrical Characteristics of the IGBT T<sub>C</sub> = 25°C unless otherwise noted

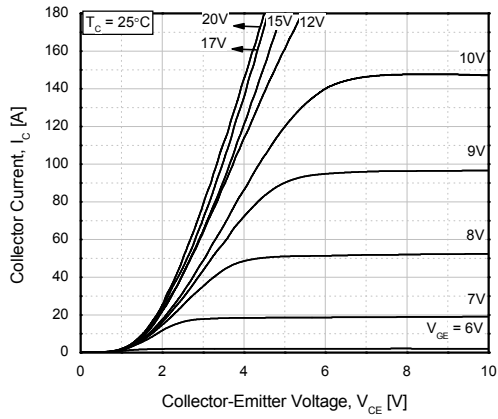
Symbol	Parameter	Test Conditions	Min.	Typ.	Max.	Unit
<b>Off Characteristics</b>						
I <sub>CES</sub>	Collector Cut-Off Current	V <sub>CE</sub> = V <sub>CES</sub> , V <sub>GE</sub> = 0 V	--	--	3	mA
I <sub>GES</sub>	G-E Leakage Current	V <sub>GE</sub> = V <sub>GES</sub> , V <sub>CE</sub> = 0 V	--	--	± 250	nA
<b>On Characteristics</b>						
V <sub>GE(th)</sub>	G-E Threshold Voltage	I <sub>C</sub> = 25 mA, V <sub>CE</sub> = V <sub>GE</sub>	3.5	5.5	7.5	V
V <sub>CE(sat)</sub>	Collector to Emitter Saturation Voltage	I <sub>C</sub> = 25 A, V <sub>GE</sub> = 15 V	--	2.0	--	V
		I <sub>C</sub> = 25 A, V <sub>GE</sub> = 15 V, T <sub>C</sub> = 125°C	--	2.15	--	V
		I <sub>C</sub> = 50 A, V <sub>GE</sub> = 15 V	--	2.65	--	V
<b>Dynamic Characteristics</b>						
C <sub>ies</sub>	Input Capacitance	V <sub>CE</sub> = 30 V, V <sub>GE</sub> = 0 V, f = 1 MHz	--	3700	--	pF
C <sub>oes</sub>	Output Capacitance		--	130	--	pF
C <sub>res</sub>	Reverse Transfer Capacitance		--	80	--	pF
<b>Switching Characteristics</b>						
t <sub>d(on)</sub>	Turn-On Delay Time	V <sub>CC</sub> = 600 V, I <sub>C</sub> = 25 A, R <sub>G</sub> = 10 Ω, V <sub>GE</sub> = 15 V, Inductive Load, T <sub>C</sub> = 25°C	--	50	--	ns
t <sub>r</sub>	Rise Time		--	60	--	ns
t <sub>d(off)</sub>	Turn-Off Delay Time		--	190	--	ns
t <sub>f</sub>	Fall Time		--	100	--	ns
E <sub>on</sub>	Turn-On Switching Loss		--	4.1	--	mJ
E <sub>off</sub>	Turn-Off Switching Loss		--	0.96	--	mJ
E <sub>ts</sub>	Total Switching Loss		--	5.06	--	mJ
t <sub>d(on)</sub>	Turn-On Delay Time	V <sub>CC</sub> = 600 V, I <sub>C</sub> = 25 A, R <sub>G</sub> = 10Ω, V <sub>GE</sub> = 15 V, Inductive Load, T <sub>C</sub> = 125°C	--	50	--	ns
t <sub>r</sub>	Rise Time		--	60	--	ns
t <sub>d(off)</sub>	Turn-Off Delay Time		--	200	--	ns
t <sub>f</sub>	Fall Time		--	154	--	ns
E <sub>on</sub>	Turn-On Switching Loss		--	4.3	--	mJ
E <sub>off</sub>	Turn-Off Switching Loss		--	1.5	--	mJ
E <sub>ts</sub>	Total Switching Loss		--	5.8	--	mJ
Q <sub>g</sub>	Total Gate Charge	V <sub>CE</sub> = 600 V, I <sub>C</sub> = 25 A, V <sub>GE</sub> = 15 V	--	200	--	nC
Q <sub>ge</sub>	Gate-Emitter Charge		--	15	--	nC
Q <sub>gc</sub>	Gate-Collector Charge		--	100	--	nC

**Electrical Characteristics of DIODE**  $T_C = 25^\circ\text{C}$  unless otherwise noted

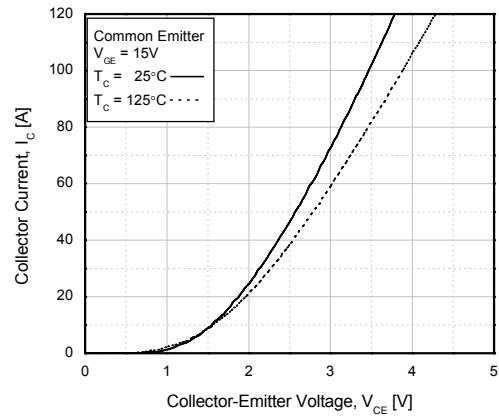
Symbol	Parameter	Test Conditions	Min.	Typ.	Max.	Unit	
$V_{FM}$	Diode Forward Voltage	$I_F = 25\text{ A}$	$T_C = 25^\circ\text{C}$	--	2.0	3.0	V
			$T_C = 125^\circ\text{C}$	--	2.1	--	
$t_{rr}$	Diode Reverse Recovery Time	$I_F = 25\text{ A}$ $di_F/dt = 200\text{ A}/\mu\text{s}$	$T_C = 25^\circ\text{C}$	--	235	350	ns
			$T_C = 125^\circ\text{C}$	--	300	--	
$I_{rr}$	Diode Peak Reverse Recovery Current	$I_F = 25\text{ A}$ $di_F/dt = 200\text{ A}/\mu\text{s}$	$T_C = 25^\circ\text{C}$	--	27	40	A
			$T_C = 125^\circ\text{C}$	--	31	--	
$Q_{rr}$	Diode Reverse Recovery Charge	$I_F = 25\text{ A}$ $di_F/dt = 200\text{ A}/\mu\text{s}$	$T_C = 25^\circ\text{C}$	--	3130	4700	nC
			$T_C = 125^\circ\text{C}$	--	4650	--	

## Typical Performance Characteristics

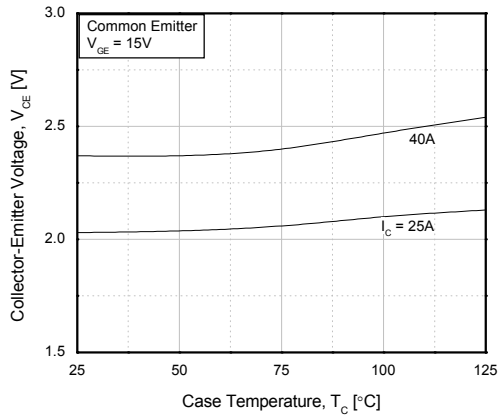
**Figure 1. Typical Output Characteristics**



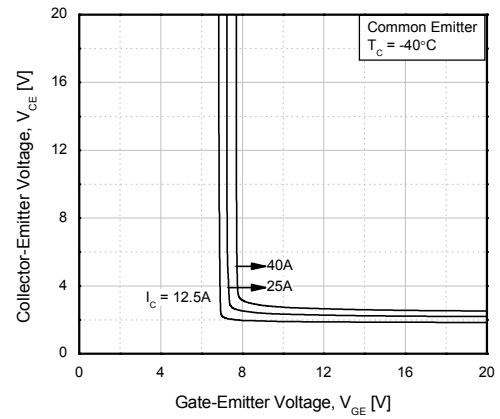
**Figure 2. Typical Saturation Voltage Characteristics**



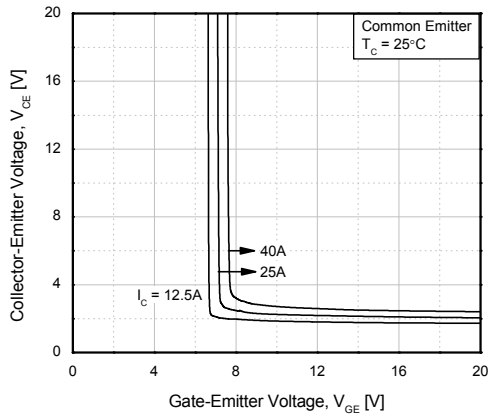
**Figure 3. Saturation Voltage vs. Case Temperature at Variant Current Level**



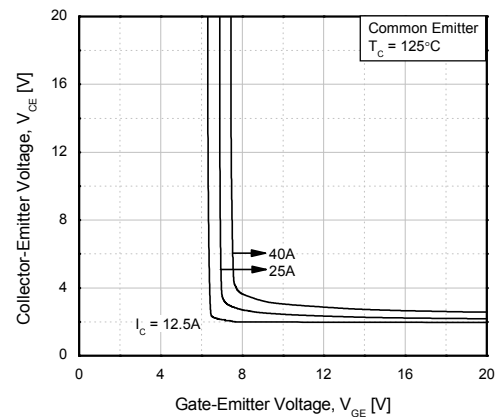
**Figure 4. Saturation Voltage vs. V\_GE**



**Figure 5. Saturation Voltage vs. V\_GE**

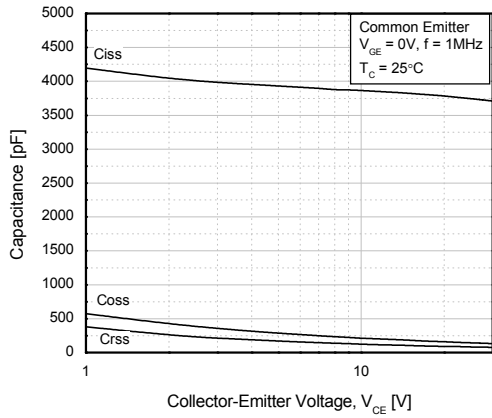


**Figure 6. Saturation Voltage vs. V\_GE**

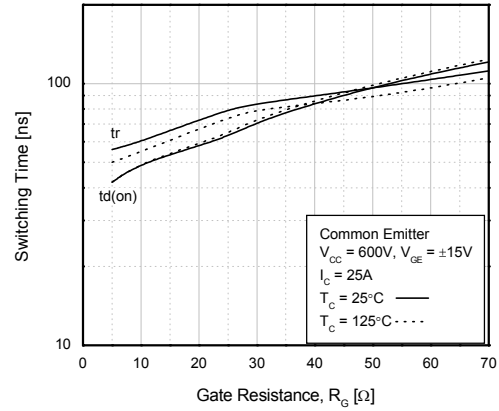


**Typical Performance Characteristics** (Continued)

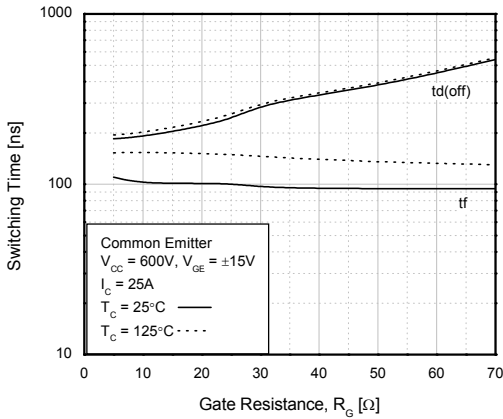
**Figure 7. Capacitance Characteristics**



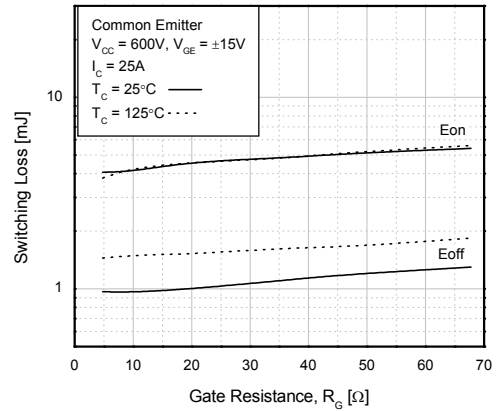
**Figure 8. Turn-On Characteristics vs. Gate Resistance**



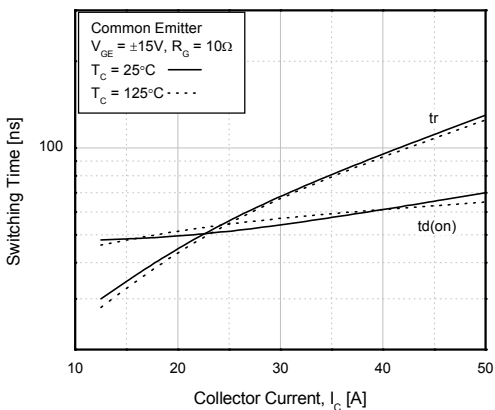
**Figure 9. Turn-Off Characteristics vs. Gate Resistance**



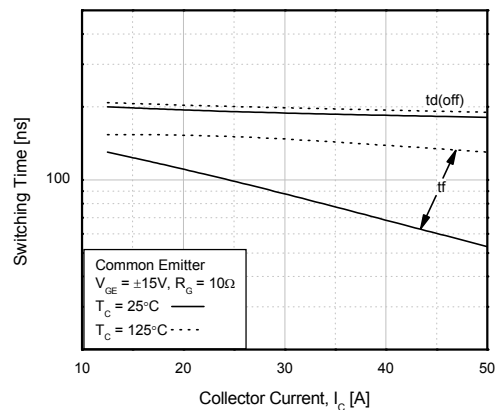
**Figure 10. Switching Loss vs. Gate Resistance**



**Figure 11. Turn-On Characteristics vs. Collector Current**

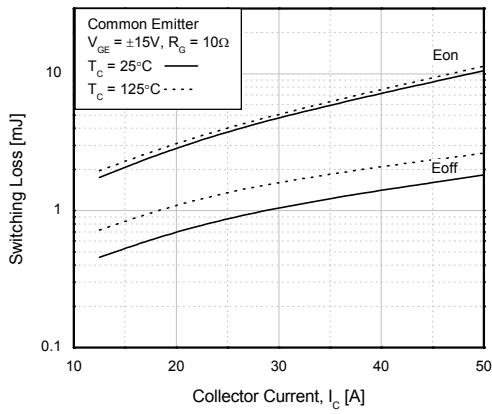


**Figure 12. Turn-Off Characteristics vs. Collector Current**

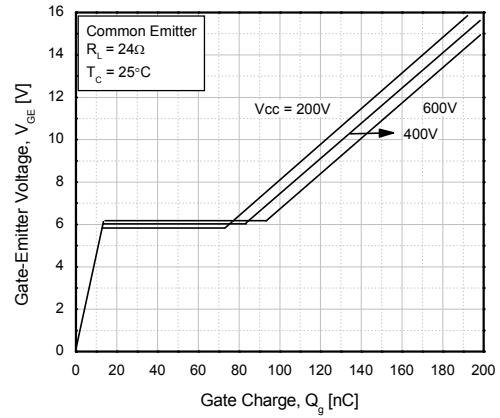


**Typical Performance Characteristics (Continued)**

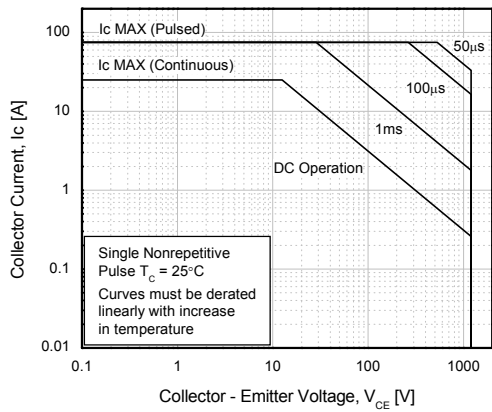
**Figure 13. Switching Loss vs. Collector Current**



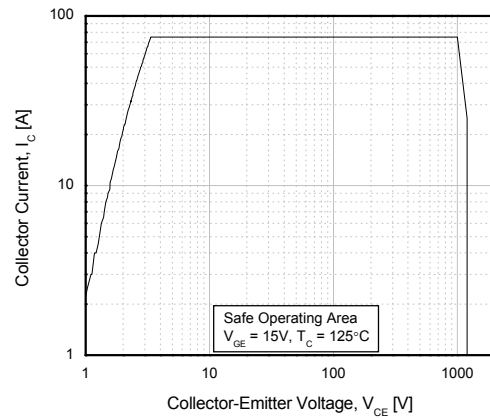
**Figure 14. Gate Charge Characteristics**



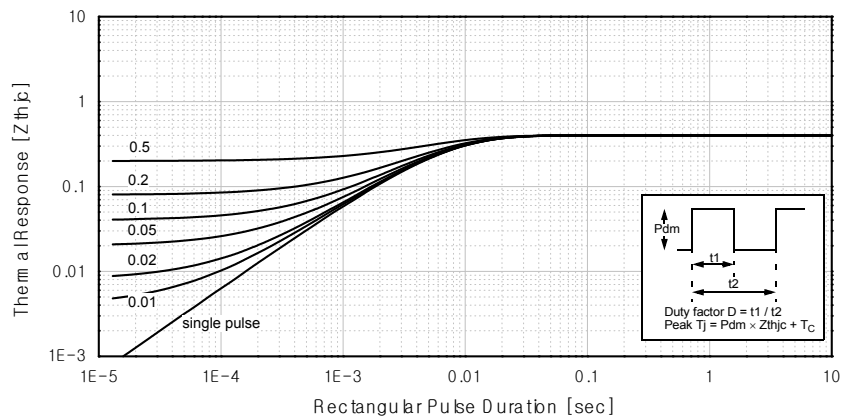
**Figure 15. SOA Characteristics**



**Figure 16. Turn-Off SOA**

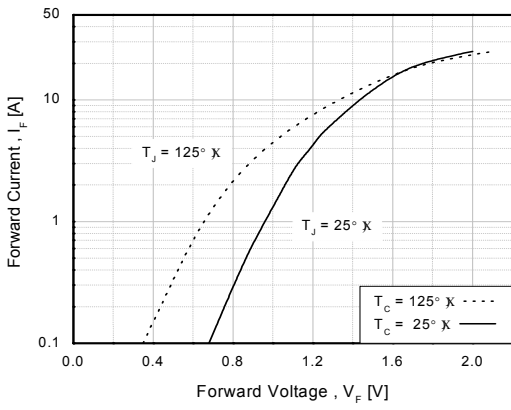


**Figure 17. Transient Thermal Impedance of IGBT**

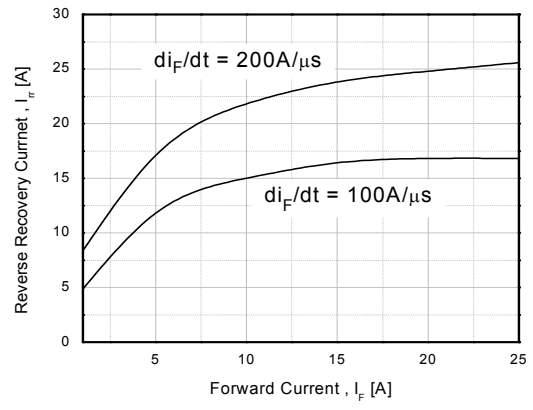


**Typical Performance Characteristics** (Continued)

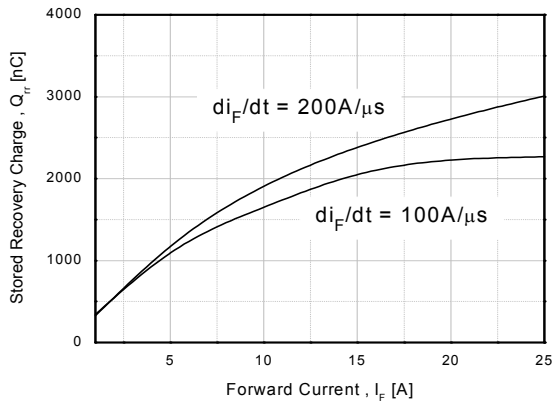
**Figure 18. Forward Characteristics**



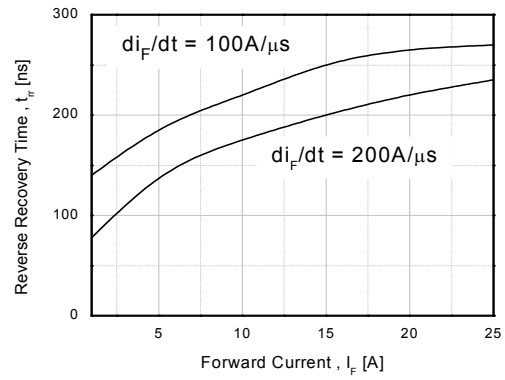
**Figure 19. Reverse Recovery Current**



**Figure 20. Stored Charge**

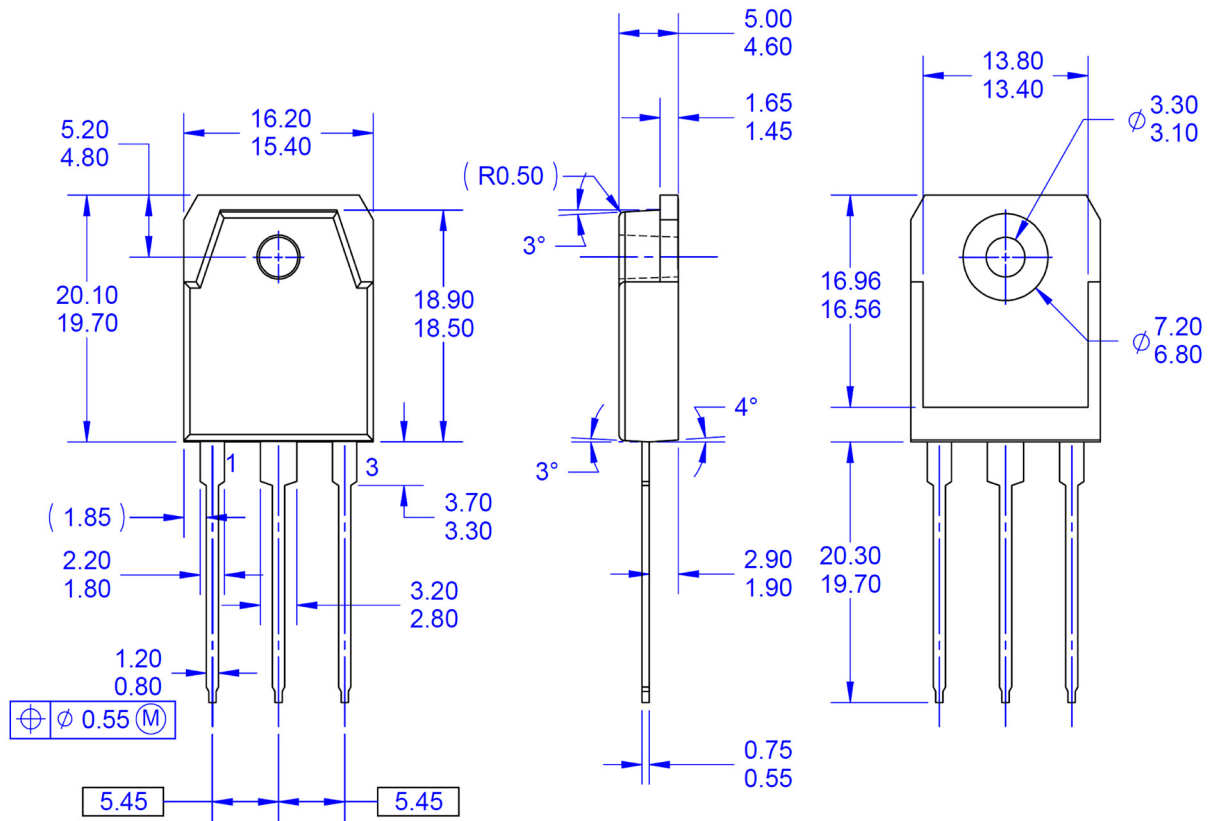


**Figure 21. Reverse Recovery Time**





**Mechanical Dimensions**



NOTES: UNLESS OTHERWISE SPECIFIED

- A) THIS PACKAGE CONFORMS TO EIAJ SC-65 PACKAGING STANDARD.
- B) ALL DIMENSIONS ARE IN MILLIMETERS.
- C) DIMENSION AND TOLERANCING PER ASME14.5-2009.
- D) DIMENSIONS ARE EXCLUSIVE OF BURRS, MOLD FLASH, AND TIE BAR EXTRUSIONS.
- E) DRAWING FILE NAME: TO3PN03AREV1.
- F) FAIRCHILD SEMICONDUCTOR.

**Figure 22. TO3PN, 3-Lead, Plastic, EIAJ SC-65**

Package drawings are provided as a service to customers considering ON Semiconductor components. Drawings may change in any manner without notice. Please note the revision and/or date on the drawing and contact a ON Semiconductor representative to verify or obtain the most recent revision. Package specifications do not expand the terms of ON Semiconductor's worldwide terms and conditions, specifically the warranty therein, which covers ON Semiconductor products.

ON Semiconductor and  are trademarks of Semiconductor Components Industries, LLC dba ON Semiconductor or its subsidiaries in the United States and/or other countries. ON Semiconductor owns the rights to a number of patents, trademarks, copyrights, trade secrets, and other intellectual property. A listing of ON Semiconductor's product/patent coverage may be accessed at [www.onsemi.com/site/pdf/Patent-Marking.pdf](http://www.onsemi.com/site/pdf/Patent-Marking.pdf). ON Semiconductor reserves the right to make changes without further notice to any products herein. ON Semiconductor makes no warranty, representation or guarantee regarding the suitability of its products for any particular purpose, nor does ON Semiconductor assume any liability arising out of the application or use of any product or circuit, and specifically disclaims any and all liability, including without limitation special, consequential or incidental damages. Buyer is responsible for its products and applications using ON Semiconductor products, including compliance with all laws, regulations and safety requirements or standards, regardless of any support or applications information provided by ON Semiconductor. "Typical" parameters which may be provided in ON Semiconductor data sheets and/or specifications can and do vary in different applications and actual performance may vary over time. All operating parameters, including "Typicals" must be validated for each customer application by customer's technical experts. ON Semiconductor does not convey any license under its patent rights nor the rights of others. ON Semiconductor products are not designed, intended, or authorized for use as a critical component in life support systems or any FDA Class 3 medical devices or medical devices with a same or similar classification in a foreign jurisdiction or any devices intended for implantation in the human body. Should Buyer purchase or use ON Semiconductor products for any such unintended or unauthorized application, Buyer shall indemnify and hold ON Semiconductor and its officers, employees, subsidiaries, affiliates, and distributors harmless against all claims, costs, damages, and expenses, and reasonable attorney fees arising out of, directly or indirectly, any claim of personal injury or death associated with such unintended or unauthorized use, even if such claim alleges that ON Semiconductor was negligent regarding the design or manufacture of the part. ON Semiconductor is an Equal Opportunity/Affirmative Action Employer. This literature is subject to all applicable copyright laws and is not for resale in any manner.

## PUBLICATION ORDERING INFORMATION

### LITERATURE FULFILLMENT:

Literature Distribution Center for ON Semiconductor  
19521 E. 32nd Pkwy, Aurora, Colorado 80011 USA  
**Phone:** 303-675-2175 or 800-344-3860 Toll Free USA/Canada  
**Fax:** 303-675-2176 or 800-344-3867 Toll Free USA/Canada  
**Email:** [orderlit@onsemi.com](mailto:orderlit@onsemi.com)

**N. American Technical Support:** 800-282-9855 Toll Free  
USA/Canada  
**Europe, Middle East and Africa Technical Support:**  
Phone: 421 33 790 2910  
**Japan Customer Focus Center**  
Phone: 81-3-5817-1050

**ON Semiconductor Website:** [www.onsemi.com](http://www.onsemi.com)  
**Order Literature:** <http://www.onsemi.com/orderlit>  
For additional information, please contact your local  
Sales Representative

## X-ON Electronics

Largest Supplier of Electrical and Electronic Components

*Click to view similar products for [IGBT Transistors](#) category:*

*Click to view products by [ON Semiconductor](#) manufacturer:*

Other Similar products are found below :

[748152A](#) [APT20GT60BRDQ1G](#) [APT50GT60BRG](#) [NGTB10N60FG](#) [STGFW20V60DF](#) [APT30GP60BG](#) [APT45GR65B2DU30](#)  
[GT50JR22\(STA1ES\)](#) [TIG058E8-TL-H](#) [VS-CPV364M4KPBF](#) [NGTB25N120FL2WAG](#) [NGTG40N120FL2WG](#) [RJH60F3DPQ-A0#T0](#)  
[APT40GR120B2SCD10](#) [APT15GT120BRG](#) [APT20GT60BRG](#) [NGTB75N65FL2WAG](#) [NGTG15N120FL2WG](#) [IXA30RG1200DHGLB](#)  
[IXA40RG1200DHGLB](#) [APT70GR65B2DU40](#) [NTE3320](#) [IHF40N65R5SXXKSA1](#) [APT70GR120J](#) [APT35GP120JDQ2](#)  
[IKZA40N65RH5XKSA1](#) [IKFW75N65ES5XKSA1](#) [IKFW50N65ES5XKSA1](#) [IKFW50N65EH5XKSA1](#) [IKFW40N65ES5XKSA1](#)  
[IKFW60N65ES5XKSA1](#) [IMBG120R090M1HXTMA1](#) [IMBG120R220M1HXTMA1](#) [XD15H120CX1](#) [XD25H120CX0](#) [XP15PJS120CL1B1](#)  
[IGW30N60H3FKSA1](#) [STGWA8M120DF3](#) [IGW08T120FKSA1](#) [IGW75N60H3FKSA1](#) [HGTG40N60B3](#) [FGH60N60SMD\\_F085](#)  
[FGH75T65UPD](#) [STGWA15H120F2](#) [IKA10N60TXKSA1](#) [IHW20N120R5XKSA1](#) [RJH60D2DPP-M0#T2](#) [IKP20N60TXKSA1](#)  
[IHW20N65R5XKSA1](#) [IDW40E65D2FKSA1](#)