

# IGBT - Field Stop, Trench

1200 V, 25 A

## FGH25T120SMD

### Description

Using innovative field stop trench IGBT technology, ON Semiconductor's new series of field stop trench IGBTs offer the optimum performance for hard switching application such as solar inverter, UPS, welder and PFC applications.

### Features

- FS Trench Technology, Positive Temperature Coefficient
- High Speed Switching
- Low Saturation Voltage:  $V_{CE(sat)} = 1.8 \text{ V @ } I_C = 25 \text{ A}$
- 100% of the Parts Tested for  $I_{LM}$  (Note 1)
- High Input Impedance
- This Device is Pb-Free and is RoHS Compliant

### Applications

- Solar Inverter, Welder, UPS & PFC Applications



ON Semiconductor®

[www.onsemi.com](http://www.onsemi.com)

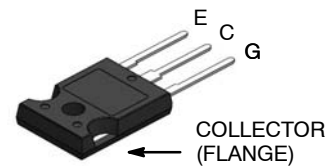
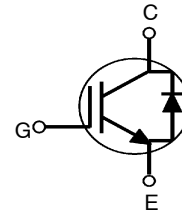

TO-247-3LD  
CASE 340CH

### MARKING DIAGRAMS

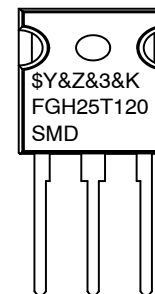

\$Y	= ON Semiconductor Logo
&Z	= Assembly Plant Code
&3	= Numeric Date Code
&K	= Lot Code
FGH25T120SMD	= Specific Device Code

### ORDERING INFORMATION

See detailed ordering and shipping information in the package dimensions section on page 2 of this data sheet.

# FGH25T120SMD

## ABSOLUTE MAXIMUM RATINGS (T<sub>C</sub> = 25°C, unless otherwise specified)

Parameter	Symbol	Ratings	Unit	
Collector to Emitter Voltage	V <sub>CES</sub>	1200	V	
Gate to Emitter Voltage	V <sub>GES</sub>	±25	V	
Transient Gate to Emitter Voltage		±30	V	
Collector Current	I <sub>C</sub>	T <sub>C</sub> = 25°C	50	A
Collector Current		T <sub>C</sub> = 100°C	25	A
Clamped Inductive Load Current (Note 1)	I <sub>LM</sub>	T <sub>C</sub> = 25°C	100	A
Pulsed Collector Current (Note 2)	I <sub>CM</sub>		100	A
Diode Continuous Forward Current	I <sub>F</sub>	T <sub>C</sub> = 25°C	50	A
Diode Continuous Forward Current		T <sub>C</sub> = 100°C	25	A
Diode Maximum Forward Current	I <sub>FM</sub>		200	A
Maximum Power Dissipation	P <sub>D</sub>	T <sub>C</sub> = 25°C	428	W
Maximum Power Dissipation		T <sub>C</sub> = 100°C	214	W
Operating Junction Temperature	T <sub>J</sub>		-55 to +175	°C
Storage Temperature Range	T <sub>stg</sub>		-55 to +175	°C
Maximum Lead Temp. for Soldering Purposes, 1/8" from Case for 5 Seconds	T <sub>L</sub>		300	°C

Stresses exceeding those listed in the Maximum Ratings table may damage the device. If any of these limits are exceeded, device functionality should not be assumed, damage may occur and reliability may be affected.

- V<sub>CC</sub> = 600 V, V<sub>GE</sub> = 15 V, I<sub>C</sub> = 100 A, R<sub>G</sub> = 23 Ω, Inductive Load
- Limited by T<sub>jmax</sub>

## THERMAL CHARACTERISTICS

Characteristic	Symbol	Value	Unit
Thermal Resistance, Junction to Case, Max. (IGBT)	R <sub>θJC</sub>	0.35	°C/W
Thermal Resistance, Junction to Case, Max. (Diode)	R <sub>θJC</sub>	1.4	°C/W
Thermal Resistance, Junction to Ambient, Max.	R <sub>θJA</sub>	40	°C/W

## PACKAGE MARKING AND ORDERING INFORMATION

Device Marking	Device	Package	Reel Size	Tape Width	Quantity
FGH25T120SMD	FGH25T120SMD-F155	TO-247-3LD	-	-	30

## ELECTRICAL CHARACTERISTICS OF THE IGBT (T<sub>C</sub> = 25°C unless otherwise noted)

Parameter	Symbol	Test Conditions	Min	Typ	Max	Unit
-----------	--------	-----------------	-----	-----	-----	------

### OFF CHARACTERISTICS

Collector to Emitter Breakdown Voltage	BV <sub>CES</sub>	V <sub>GE</sub> = 0 V, I <sub>C</sub> = 250 μA	1200	-	-	V
Collector Cut-Off Current	I <sub>CES</sub>	V <sub>CE</sub> = V <sub>CES</sub> , V <sub>GE</sub> = 0 V	-	-	250	μA
G-E Leakage Current	I <sub>GES</sub>	V <sub>GE</sub> = V <sub>GES</sub> , V <sub>CE</sub> = 0 V	-	-	±400	nA

### ON CHARACTERISTICS

G-E Threshold Voltage	V <sub>GE(th)</sub>	I <sub>C</sub> = 25 mA, V <sub>CE</sub> = V <sub>GE</sub>	4.9	6.2	7.5	V
Collector to Emitter Saturation Voltage	V <sub>CE(sat)</sub>	I <sub>C</sub> = 25 A, V <sub>GE</sub> = 15 V, T <sub>C</sub> = 25°C	-	1.8	2.4	V
		I <sub>C</sub> = 25 A, V <sub>GE</sub> = 15 V, T <sub>C</sub> = 175°C	-	1.9	-	V

# FGH25T120SMD

## ELECTRICAL CHARACTERISTICS OF THE IGBT ( $T_C = 25^\circ\text{C}$ unless otherwise noted) (continued)

Parameter	Symbol	Test Conditions	Min	Typ	Max	Unit
<b>DYNAMIC CHARACTERISTICS</b>						
Input Capacitance	$C_{ies}$	$V_{CE} = 30\text{ V}, V_{GE} = 0\text{ V}, f = 1\text{ MHz}$	–	2800	–	pF
Output Capacitance	$C_{oes}$		–	105	–	pF
Reverse Transfer Capacitance	$C_{res}$		–	60	–	pF
<b>SWITCHING CHARACTERISTICS</b>						
Turn-On Delay Time	$t_{d(on)}$	$V_{CC} = 600\text{ V}, I_C = 25\text{ A},$ $R_G = 23\ \Omega, V_{GE} = 15\text{ V},$ Inductive Load, $T_C = 25^\circ\text{C}$	–	40	–	ns
Rise Time	$t_r$		–	45	–	ns
Turn-Off Delay Time	$t_{d(off)}$		–	490	–	ns
Fall Time	$t_f$		–	12	–	ns
Turn-On Switching Loss	$E_{on}$		–	1.74	–	mJ
Turn-Off Switching Loss	$E_{off}$		–	0.56	–	mJ
Total Switching Loss	$E_{ts}$		–	2.30	–	mJ
Turn-On Delay Time	$t_{d(on)}$	$V_{CC} = 600\text{ V}, I_C = 25\text{ A},$ $R_G = 23\ \Omega, V_{GE} = 15\text{ V},$ Inductive Load, $T_C = 175^\circ\text{C}$	–	40	–	ns
Rise Time	$t_r$		–	48	–	ns
Turn-Off Delay Time	$t_{d(off)}$		–	520	–	ns
Fall Time	$t_f$		–	64	–	ns
Turn-On Switching Loss	$E_{on}$		–	2.94	–	mJ
Turn-Off Switching Loss	$E_{off}$		–	1.09	–	mJ
Total Switching Loss	$E_{ts}$		–	4.03	–	mJ
Total Gate Charge	$Q_g$	$V_{CE} = 600\text{ V}, I_C = 25\text{ A}, V_{GE} = 15\text{ V}$	–	225	–	nC
Gate to Emitter Charge	$Q_{ge}$		–	20	–	nC
Gate to Collector Charge	$Q_{gc}$		–	128	–	nC

## ELECTRICAL CHARACTERISTICS OF THE DIODE ( $T_C = 25^\circ\text{C}$ unless otherwise noted)

Parameter	Symbol	Test Conditions	Min	Typ	Max	Unit
Diode Forward Voltage	$V_{FM}$	$I_F = 25\text{ A}, T_C = 25^\circ\text{C}$	–	2.8	3.7	V
		$I_F = 25\text{ A}, T_C = 175^\circ\text{C}$	–	2.1	–	V
Diode Reverse Recovery Time	$t_{rr}$	$V_R = 600\text{ V}, I_F = 25\text{ A},$ $di_F/dt = 200\text{ A}/\mu\text{s}, T_C = 25^\circ\text{C}$	–	60	–	ns
Diode Peak Reverse Recovery Current	$I_{rr}$		–	6.6	–	A
Diode Reverse Recovery Charge	$Q_{rr}$		–	197	–	nC
Reverse Recovery Energy	$E_{rec}$	$V_R = 600\text{ V}, I_F = 25\text{ A},$ $di_F/dt = 200\text{ A}/\mu\text{s}, T_C = 175^\circ\text{C}$	–	330	–	$\mu\text{J}$
Diode Reverse Recovery Time	$t_{rr}$		–	325	–	ns
Diode Peak Reverse Recovery Current	$I_{rr}$		–	13	–	A
Diode Reverse Recovery Charge	$Q_{rr}$		–	2113	–	nC

Product parametric performance is indicated in the Electrical Characteristics for the listed test conditions, unless otherwise noted. Product performance may not be indicated by the Electrical Characteristics if operated under different conditions.

# FGH25T120SMD

## TYPICAL PERFORMANCE CHARACTERISTICS

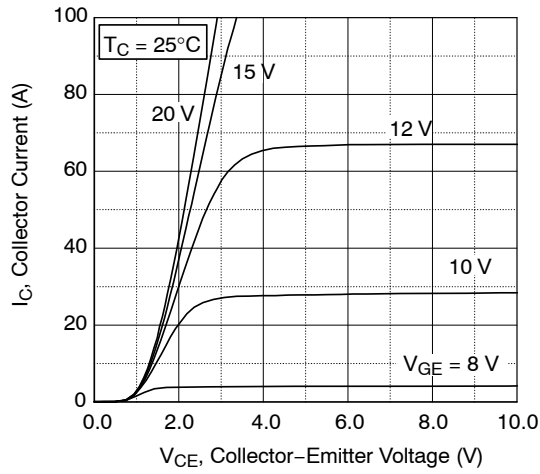

**Figure 1. Typical Output Characteristics**

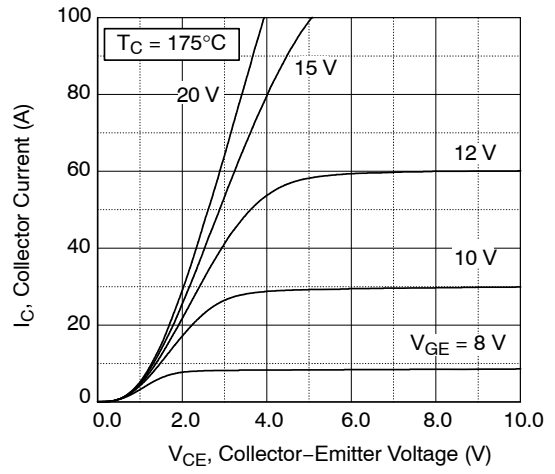

**Figure 2. Typical Output Characteristics**

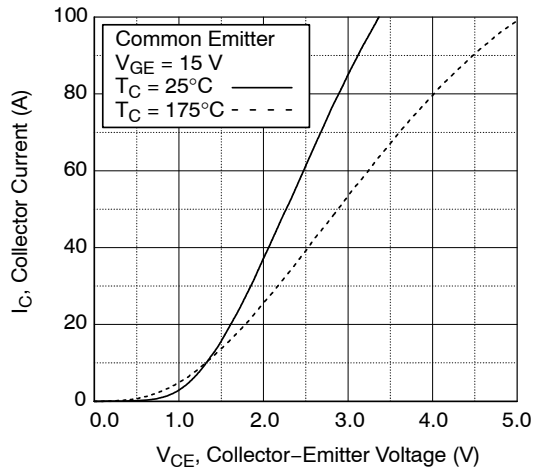

**Figure 3. Typical Saturation Voltage Characteristics**

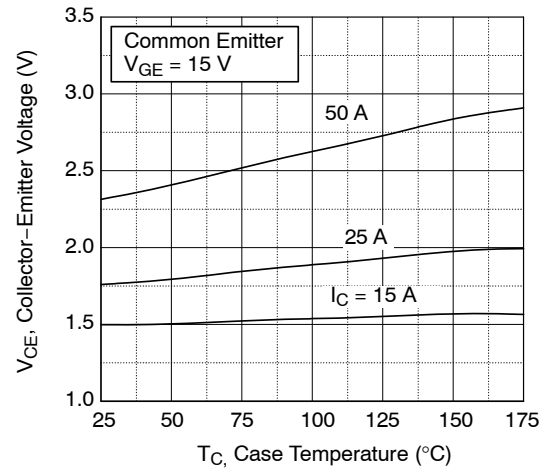

**Figure 4. Saturation Voltage vs. Case Temperature at Variant Current Level**

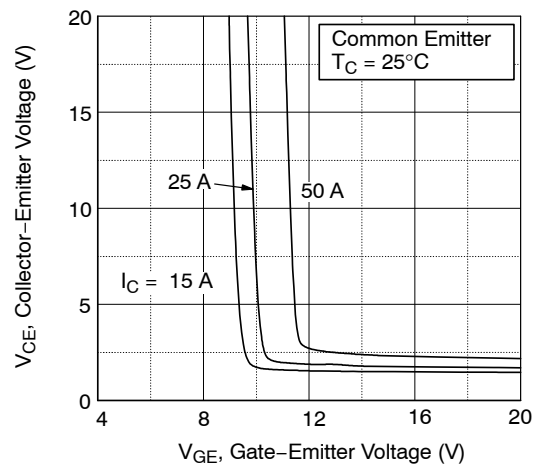

**Figure 5. Saturation Voltage vs.  $V_{GE}$**

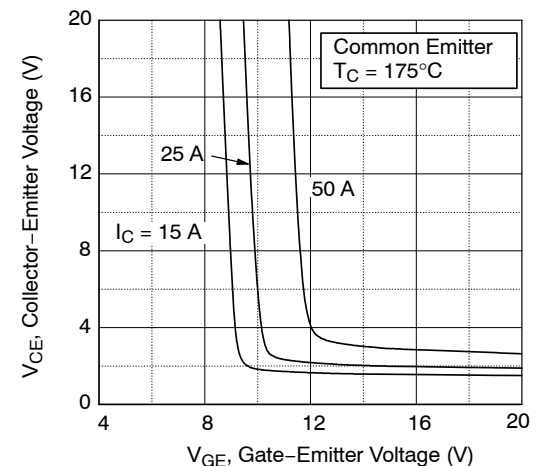

**Figure 6. Saturation Voltage vs.  $V_{GE}$**

TYPICAL PERFORMANCE CHARACTERISTICS (continued)

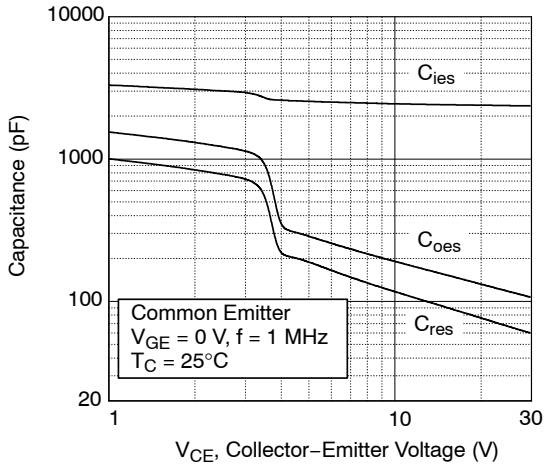

Figure 7. Capacitance Characteristics

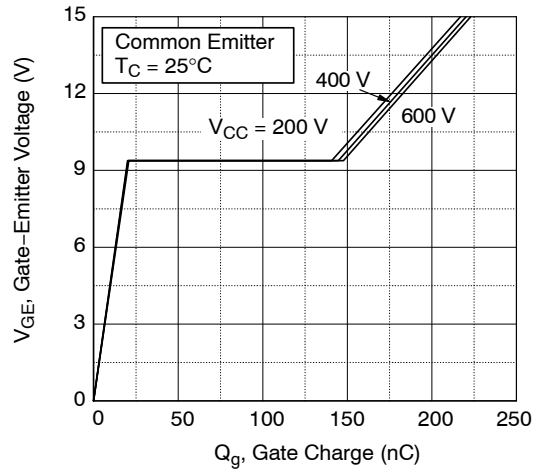

Figure 8. Gate Charge Characteristics

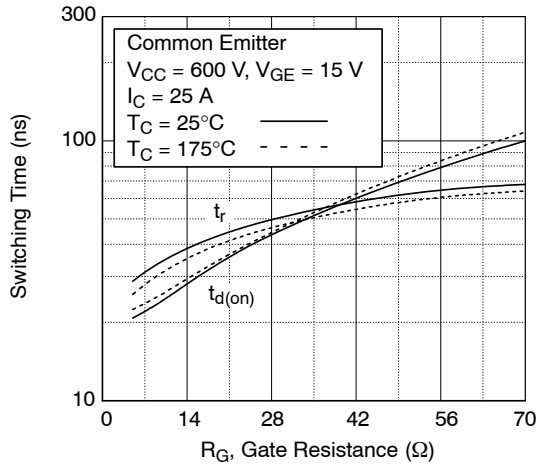

Figure 9. Turn-On Characteristics vs. Gate Resistance

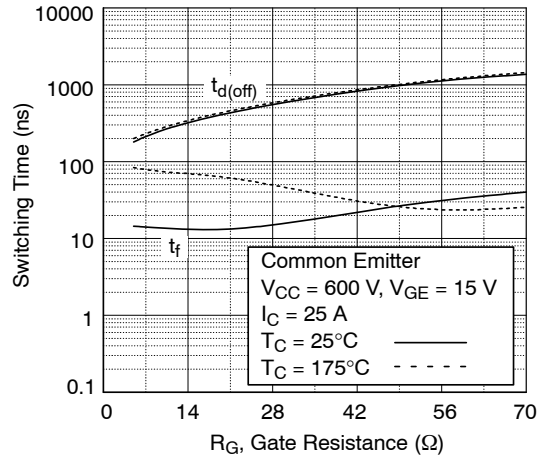

Figure 10. Turn-Off Characteristics vs. Gate Resistance

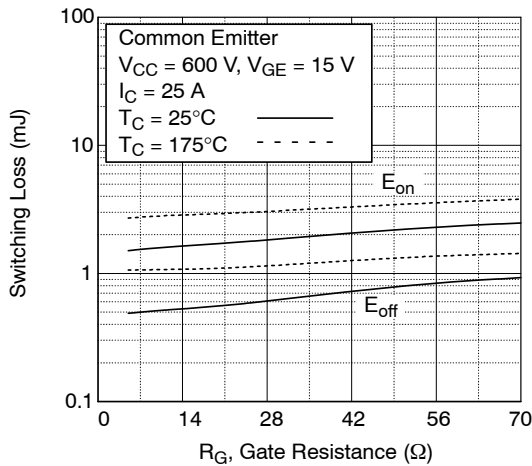

Figure 11. Switching Loss vs. Gate Resistance

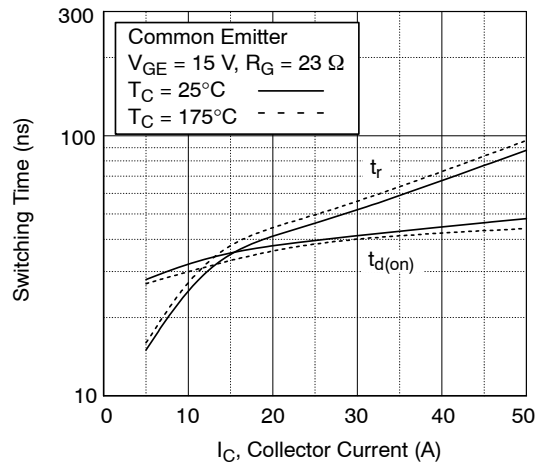
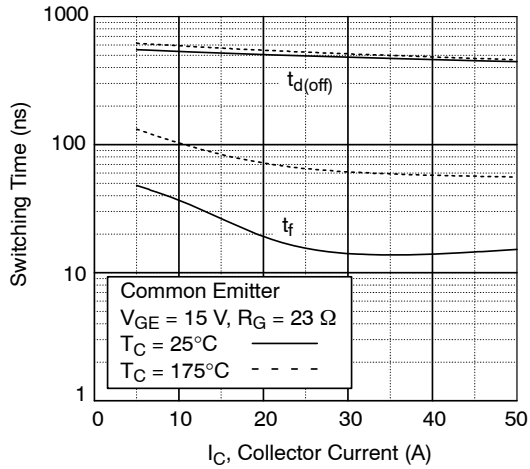

Figure 12. Turn-On Characteristics vs. Collector Current

# FGH25T120SMD

## TYPICAL PERFORMANCE CHARACTERISTICS (continued)



**Figure 13. Turn-Off Characteristics vs. Collector Current**

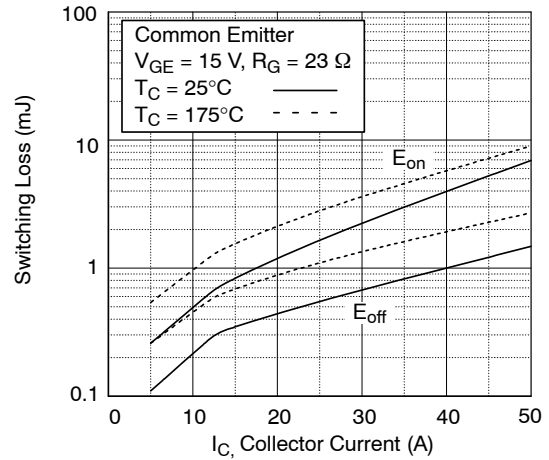

**Figure 14. Switching Loss vs. Collector Current**

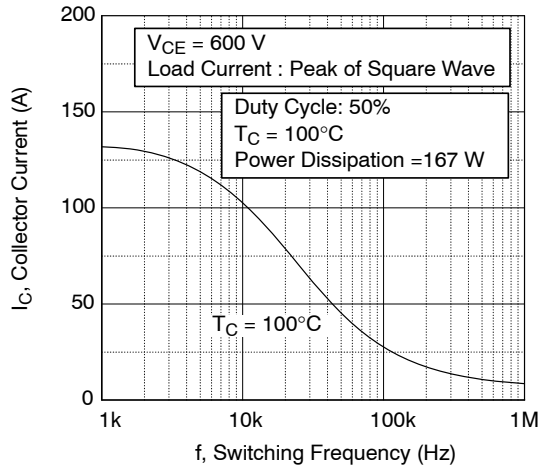

**Figure 15. Load Current vs. Frequency**

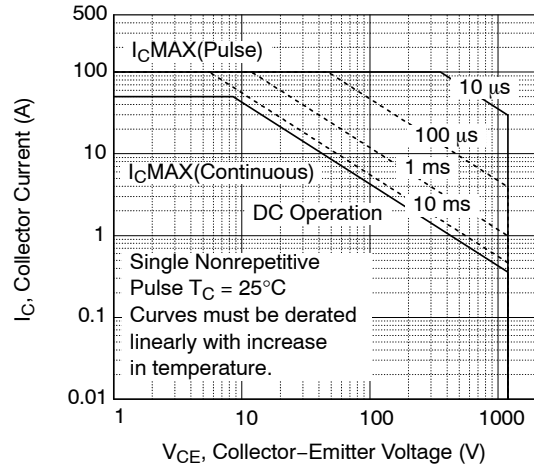

**Figure 16. SOA Characteristics**

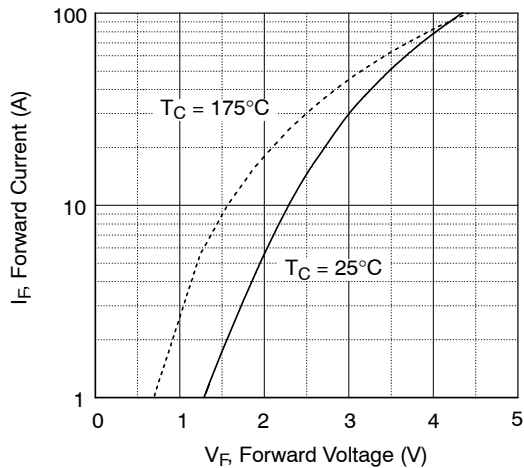

**Figure 17. Forward Characteristics**

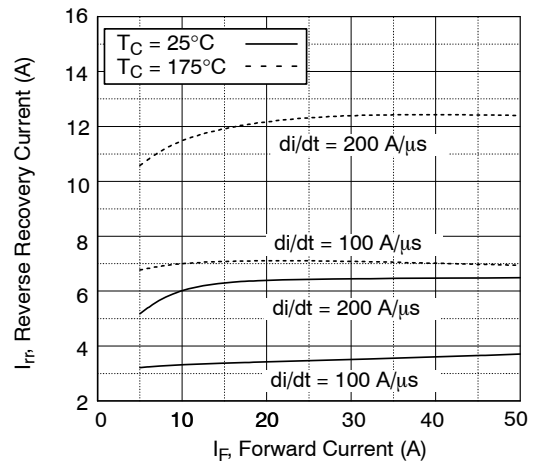

**Figure 18. Reverse Recovery Current**

# FGH25T120SMD

## TYPICAL PERFORMANCE CHARACTERISTICS (continued)

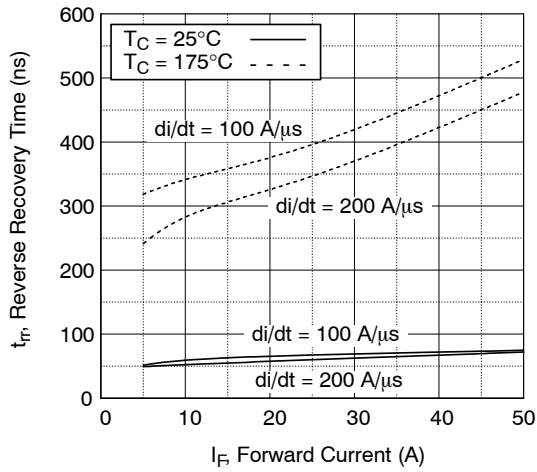

Figure 19. Reverse Recovery Time

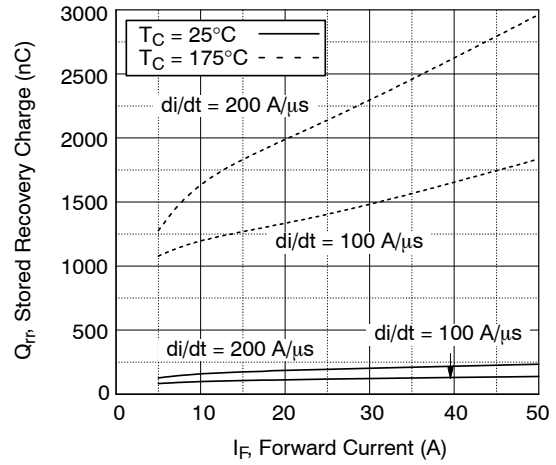

Figure 20. Stored Charge

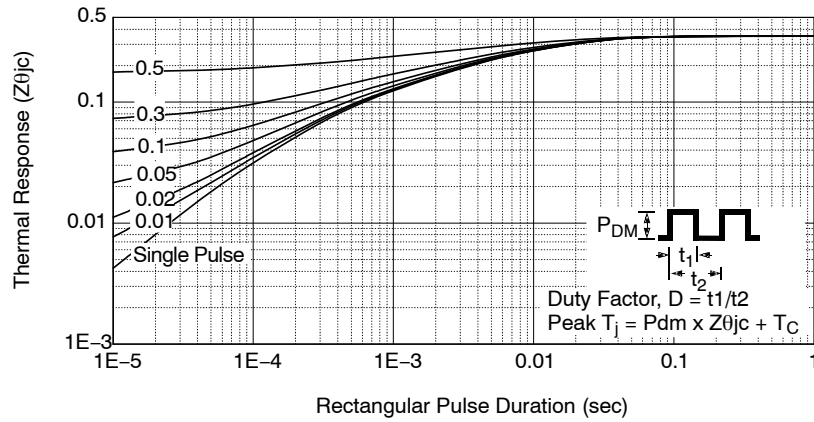

Figure 21. Transient Thermal Impedance of IGBT

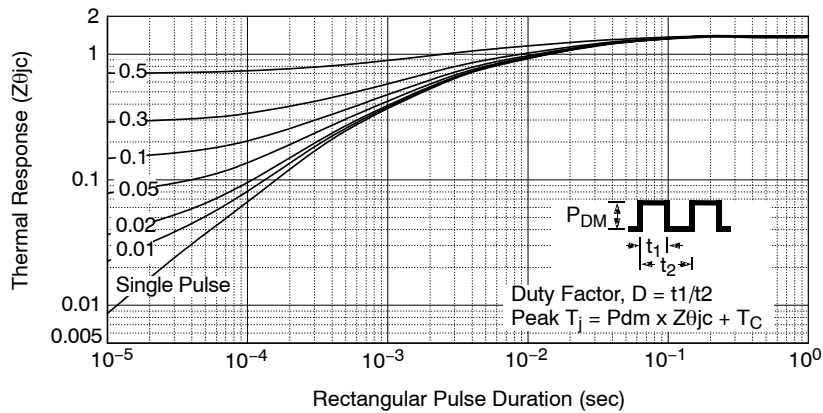

Figure 22. Transient Thermal Impedance of Diode

# MECHANICAL CASE OUTLINE PACKAGE DIMENSIONS

ON Semiconductor®



TO-247-3LD  
CASE 340CH  
ISSUE A

DATE 09 OCT 2019



NOTES: UNLESS OTHERWISE SPECIFIED.

- A. DIMENSIONS ARE EXCLUSIVE OF BURRS, MOLD FLASH, AND TIE BAR EXTRUSIONS.
- B. ALL DIMENSIONS ARE IN MILLIMETERS.
- C. DRAWING CONFORMS TO ASME Y14.5 - 2009.
- D. DIMENSION A1 TO BE MEASURED IN THE REGION DEFINED BY L1.
- E. LEAD FINISH IS UNCONTROLLED IN THE REGION DEFINED BY L1.

### GENERIC MARKING DIAGRAM\*



XXXX = Specific Device Code  
A = Assembly Location  
Y = Year  
WW = Work Week  
G = Pb-Free Package

\*This information is generic. Please refer to device data sheet for actual part marking. Pb-Free indicator, "G" or microdot "•", may or may not be present. Some products may not follow the Generic Marking.

DIM	MILLIMETERS		
	MIN	NOM	MAX
A	4.58	4.70	4.82
A1	2.29	2.475	2.66
A2	1.40	1.50	1.60
D	20.32	20.57	20.82
E	15.37	15.62	15.87
E2	4.96	5.08	5.20
e	~	5.56	~
L	19.75	20.00	20.25
L1	3.69	3.81	3.93
∅P	3.51	3.58	3.65
Q	5.34	5.46	5.58
S	5.34	5.46	5.58
b	1.17	1.26	1.35
b2	1.53	1.65	1.77
b4	2.42	2.54	2.66
c	0.51	0.61	0.71
D1	13.08	~	~
D2	0.51	0.93	1.35
E1	12.81	~	~
∅P1	6.61	6.73	6.85

DOCUMENT NUMBER:	98AON13853G	Electronic versions are uncontrolled except when accessed directly from the Document Repository. Printed versions are uncontrolled except when stamped "CONTROLLED COPY" in red.
DESCRIPTION:	TO-247-3LD	PAGE 1 OF 1

ON Semiconductor and are trademarks of Semiconductor Components Industries, LLC dba ON Semiconductor or its subsidiaries in the United States and/or other countries. ON Semiconductor reserves the right to make changes without further notice to any products herein. ON Semiconductor makes no warranty, representation or guarantee regarding the suitability of its products for any particular purpose, nor does ON Semiconductor assume any liability arising out of the application or use of any product or circuit, and specifically disclaims any and all liability, including without limitation special, consequential or incidental damages. ON Semiconductor does not convey any license under its patent rights nor the rights of others.



ON Semiconductor and  are trademarks of Semiconductor Components Industries, LLC dba ON Semiconductor or its subsidiaries in the United States and/or other countries. ON Semiconductor owns the rights to a number of patents, trademarks, copyrights, trade secrets, and other intellectual property. A listing of ON Semiconductor's product/patent coverage may be accessed at [www.onsemi.com/site/pdf/Patent-Marking.pdf](http://www.onsemi.com/site/pdf/Patent-Marking.pdf). ON Semiconductor reserves the right to make changes without further notice to any products herein. ON Semiconductor makes no warranty, representation or guarantee regarding the suitability of its products for any particular purpose, nor does ON Semiconductor assume any liability arising out of the application or use of any product or circuit, and specifically disclaims any and all liability, including without limitation special, consequential or incidental damages. Buyer is responsible for its products and applications using ON Semiconductor products, including compliance with all laws, regulations and safety requirements or standards, regardless of any support or applications information provided by ON Semiconductor. "Typical" parameters which may be provided in ON Semiconductor data sheets and/or specifications can and do vary in different applications and actual performance may vary over time. All operating parameters, including "Typicals" must be validated for each customer application by customer's technical experts. ON Semiconductor does not convey any license under its patent rights nor the rights of others. ON Semiconductor products are not designed, intended, or authorized for use as a critical component in life support systems or any FDA Class 3 medical devices or medical devices with a same or similar classification in a foreign jurisdiction or any devices intended for implantation in the human body. Should Buyer purchase or use ON Semiconductor products for any such unintended or unauthorized application, Buyer shall indemnify and hold ON Semiconductor and its officers, employees, subsidiaries, affiliates, and distributors harmless against all claims, costs, damages, and expenses, and reasonable attorney fees arising out of, directly or indirectly, any claim of personal injury or death associated with such unintended or unauthorized use, even if such claim alleges that ON Semiconductor was negligent regarding the design or manufacture of the part. ON Semiconductor is an Equal Opportunity/Affirmative Action Employer. This literature is subject to all applicable copyright laws and is not for resale in any manner.

## PUBLICATION ORDERING INFORMATION

### LITERATURE FULFILLMENT:

Email Requests to: [orderlit@onsemi.com](mailto:orderlit@onsemi.com)

ON Semiconductor Website: [www.onsemi.com](http://www.onsemi.com)

### TECHNICAL SUPPORT

North American Technical Support:  
Voice Mail: 1 800-282-9855 Toll Free USA/Canada  
Phone: 011 421 33 790 2910

Europe, Middle East and Africa Technical Support:

Phone: 00421 33 790 2910

For additional information, please contact your local Sales Representative

## X-ON Electronics

Largest Supplier of Electrical and Electronic Components

*Click to view similar products for [IGBT Transistors](#) category:*

*Click to view products by [ON Semiconductor](#) manufacturer:*

Other Similar products are found below :

[748152A](#) [FGH60T65SHD\\_F155](#) [APT100GT60B2RG](#) [APT13GP120BG](#) [APT20GN60BG](#) [APT20GT60BRDQ1G](#) [APT25GN120B2DQ2G](#)  
[APT35GA90BD15](#) [APT36GA60BD15](#) [APT40GP60B2DQ2G](#) [APT40GP90B2DQ2G](#) [APT50GN120B2G](#) [APT50GT60BRG](#)  
[APT64GA90B2D30](#) [APT70GR120J](#) [NGTB10N60FG](#) [NGTB30N60L2WG](#) [NGTG25N120FL2WG](#) [IGP30N60H3XKSA1](#) [STGB15H60DF](#)  
[STGFW20V60DF](#) [STGFW30V60DF](#) [STGFW40V60F](#) [STGWA25H120DF2](#) [FGB3236\\_F085](#) [APT25GN120BG](#) [APT25GR120S](#)  
[APT30GN60BDQ2G](#) [APT30GN60BG](#) [APT30GP60BG](#) [APT30GS60BRDQ2G](#) [APT30N60BC6](#) [APT35GP120JDQ2](#) [APT36GA60B](#)  
[APT45GR65B2DU30](#) [APT50GP60B2DQ2G](#) [APT68GA60B](#) [APT70GR65B](#) [APT70GR65B2SCD30](#) [GT50JR22\(STA1ES\)](#) [TIG058E8-TL-H](#)  
[IDW40E65D2](#) [SGB15N120ATMA1](#) [NGTB50N60L2WG](#) [STGB10H60DF](#) [STGB20V60F](#) [STGB40V60F](#) [STGFW80V60F](#)  
[IGW40N120H3FKSA1](#) [RJH60D7BDPQ-E0#T2](#)