

# IGBT - Shorted-anode

1500 V, 30 A

## FGH30S150P

### Description

Using advanced field stop trench and shorted-anode technology, ON Semiconductor's shorted-anode trench IGBTs offer superior conduction and switching performances for soft switching applications. The device can operate in parallel configuration with exceptional avalanche capability. This device is designed for induction heating and microwave oven.

### Features

- High Speed Switching
- Low Saturation Voltage:  $V_{CE(sat)} = 1.85 \text{ V @ } I_C = 30 \text{ A}$
- High Input Impedance
- This Device is Pb-Free and is RoHS Compliant

### Applications

- Induction Heating, Microwave Oven



ON Semiconductor®

[www.onsemi.com](http://www.onsemi.com)

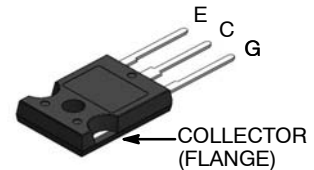
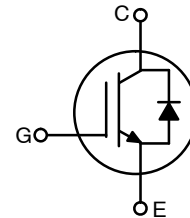

TO-247-3LD  
CASE 340CK

### MARKING DIAGRAM

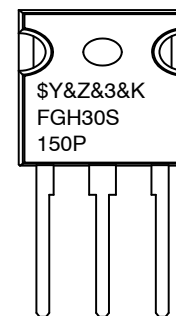

\$Y	= ON Semiconductor Logo
&Z	= Assembly Plant Code
&3	= Numeric Date Code
&K	= Lot Code
FGH30S150P	= Specific Device Code

### ORDERING INFORMATION

See detailed ordering and shipping information in the package dimensions section on page 2 of this data sheet.

# FGH30S150P

## ABSOLUTE MAXIMUM RATINGS (T<sub>C</sub> = 25°C unless otherwise noted)

Description		Symbol	Rating	Unit
Collector to Emitter Voltage		V <sub>CES</sub>	1500	V
Gate to Emitter Voltage		V <sub>GES</sub>	±25	V
Collector Current	T <sub>C</sub> = 25°C	I <sub>C</sub>	60	A
Collector Current	T <sub>C</sub> = 100°C		30	A
Pulsed Collector Current		I <sub>CM</sub> (Note 1)	90	A
Diode Continuous Forward Current	T <sub>C</sub> = 25°C	I <sub>F</sub>	60	A
Diode Continuous Forward Current	T <sub>C</sub> = 100°C		30	A
Maximum Power Dissipation	T <sub>C</sub> = 25°C	P <sub>D</sub>	500	W
Maximum Power Dissipation	T <sub>C</sub> = 100°C		250	W
Operating Junction Temperature		T <sub>J</sub>	-55 to +175	°C
Storage Temperature Range		T <sub>stg</sub>	-55 to +175	°C
Maximum Lead Temp. for soldering Purposes, 1/8" from case for 5 seconds		T <sub>L</sub>	300	°C

Stresses exceeding those listed in the Maximum Ratings table may damage the device. If any of these limits are exceeded, device functionality should not be assumed, damage may occur and reliability may be affected.

1. Limited by T<sub>jmax</sub>.

## THERMAL CHARACTERISTICS

Parameter	Symbol	Typ	Max	Unit
Thermal Resistance, Junction to Case, Max	R <sub>θJC</sub> (IGBT)	-	0.3	°C/W
Thermal Resistance, Junction to Ambient, Max	R <sub>θJA</sub>	-	40	°C/W

## PACKAGE MARKING AND ORDERING INFORMATION

Part Number	Top Mark	Package	Reel Size	Tape Width	Quantity
FGH30S150P	FGH30S150P	TO-247	-	-	30

## ELECTRICAL CHARACTERISTICS OF THE IGBT (T<sub>C</sub> = 25°C unless otherwise noted)

Parameter	Symbol	Test Conditions	Min	Typ	Max	Unit
-----------	--------	-----------------	-----	-----	-----	------

### OFF CHARACTERISTICS

Collector to Emitter Breakdown Voltage	BV <sub>CES</sub>	V <sub>GE</sub> = 0 V, I <sub>C</sub> = 1 mA	1500	-	-	V
Temperature Coefficient of Breakdown Voltage	ΔBV <sub>CES</sub> /ΔT <sub>J</sub>	V <sub>GE</sub> = 0 V, I <sub>C</sub> = 1 mA	-	1.5	-	V/°C
Collector Cut-Off Current	I <sub>CES</sub>	V <sub>CE</sub> = 1500, V <sub>GE</sub> = 0 V	-	-	1	mA
G-E Leakage Current	I <sub>GES</sub>	V <sub>GE</sub> = V <sub>GES</sub> , V <sub>CE</sub> = 0 V	-	-	±500	nA

### ON CHARACTERISTICS

G-E Threshold Voltage	V <sub>GE(th)</sub>	I <sub>C</sub> = 30 mA, V <sub>CE</sub> = V <sub>GE</sub>	4.5	6.0	7.5	V
Collector to Emitter Saturation Voltage	V <sub>CE(sat)</sub>	I <sub>C</sub> = 30 A, V <sub>GE</sub> = 15 V, T <sub>C</sub> = 25°C	-	1.85	2.4	V
		I <sub>C</sub> = 30 A, V <sub>GE</sub> = 15 V, T <sub>C</sub> = 125°C	-	2.06	-	V
		I <sub>C</sub> = 30 A, V <sub>GE</sub> = 15 V, T <sub>C</sub> = 175°C	-	2.15	-	V
Diode Forward Voltage	V <sub>FM</sub>	I <sub>F</sub> = 30 A, T <sub>C</sub> = 25°C	-	1.61	2.2	V
		I <sub>F</sub> = 30 A, T <sub>C</sub> = 175°C	-	1.96	-	V

# FGH30S150P

## ELECTRICAL CHARACTERISTICS OF THE IGBT ( $T_C = 25^\circ\text{C}$ unless otherwise noted) (continued)

Parameter	Symbol	Test Conditions	Min	Typ	Max	Unit
<b>DYNAMIC CHARACTERISTICS</b>						
Input Capacitance	$C_{ies}$	$V_{CE} = 30\text{ V}, V_{GE} = 0\text{ V}, f = 1\text{ MHz}$	–	3310	–	pF
Output Capacitance	$C_{oes}$		–	70	–	pF
Reverse Transfer Capacitance	$C_{res}$		–	55	–	pF
<b>SWITCHING CHARACTERISTICS</b>						
Turn-On Delay Time	$t_{d(on)}$	$V_{CC} = 600\text{ V}, I_C = 30\text{ A},$ $R_G = 10\ \Omega, V_{GE} = 15\text{ V},$ Resistive Load, $T_C = 25^\circ\text{C}$	–	32	–	ns
Rise Time	$t_r$		–	292	–	ns
Turn-Off Delay Time	$t_{d(off)}$		–	492	–	ns
Fall Time	$t_f$		–	214	–	ns
Turn-On Switching Loss	$E_{on}$		–	1.16	–	mJ
Turn-Off Switching Loss	$E_{off}$		–	0.9	–	mJ
Total Switching Loss	$E_{ts}$		–	2.06	–	mJ
Turn-On Delay Time	$t_{d(on)}$	$V_{CC} = 600\text{ V}, I_C = 30\text{ A},$ $R_G = 10\ \Omega, V_{GE} = 15\text{ V},$ Resistive Load, $T_C = 175^\circ\text{C}$	–	36	–	ns
Rise Time	$t_r$		–	336	–	ns
Turn-Off Delay Time	$t_{d(off)}$		–	560	–	ns
Fall Time	$t_f$		–	520	–	ns
Turn-On Switching Loss	$E_{on}$		–	1.39	–	mJ
Turn-Off Switching Loss	$E_{off}$		–	1.86	–	mJ
Total Switching Loss	$E_{ts}$		–	3.25	–	mJ
Total Gate Charge	$Q_g$	$V_{CE} = 600\text{ V}, I_C = 30\text{ A}, V_{GE} = 15\text{ V}$	–	369	–	nC
Gate to Emitter Charge	$Q_{ge}$		–	23.5	–	nC
Gate to Collector Charge	$Q_{gc}$		–	199	–	nC

Product parametric performance is indicated in the Electrical Characteristics for the listed test conditions, unless otherwise noted. Product performance may not be indicated by the Electrical Characteristics if operated under different conditions.

TYPICAL PERFORMANCE CHARACTERISTICS

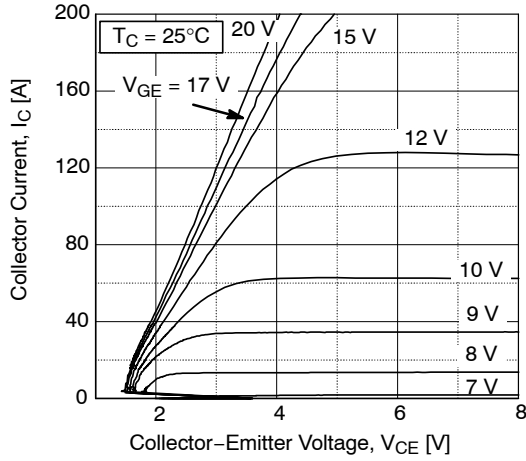

Figure 1. Typical Output Characteristics

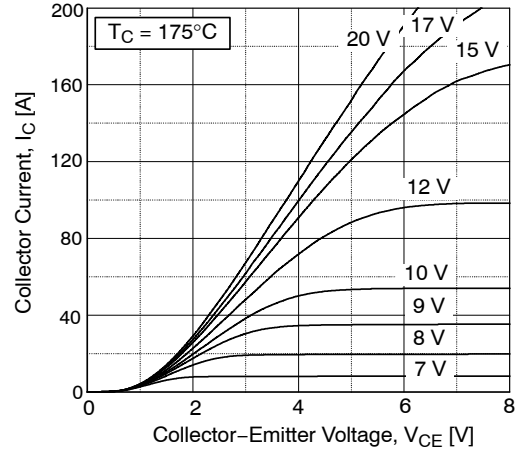

Figure 2. Typical Output Characteristics

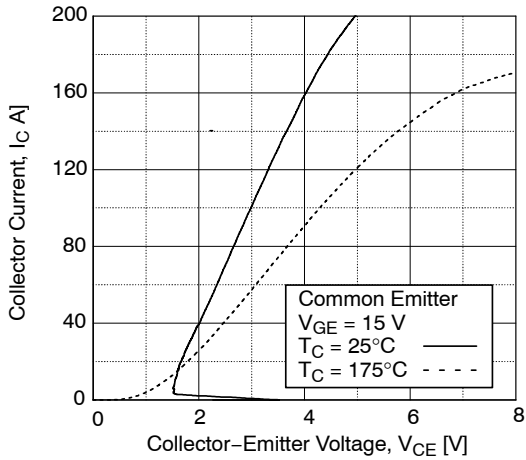

Figure 3. Typical Saturation Voltage Characteristics

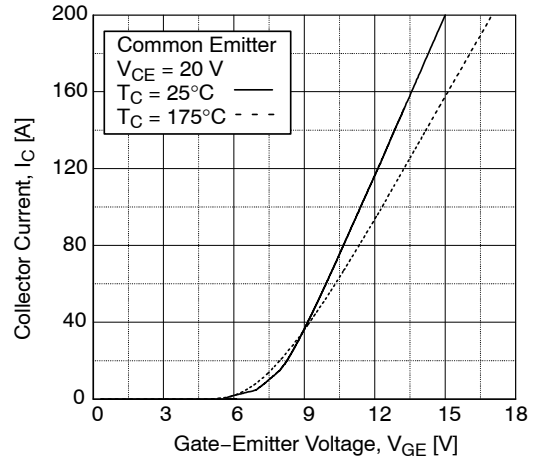

Figure 4. Transfer Characteristics

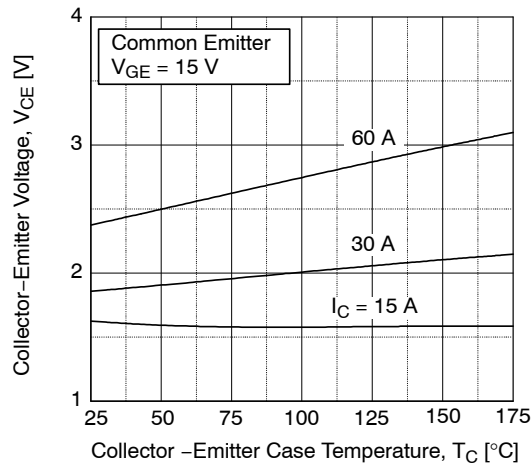

Figure 5. Saturation Voltage vs. Case Temperature at Variant Current Level

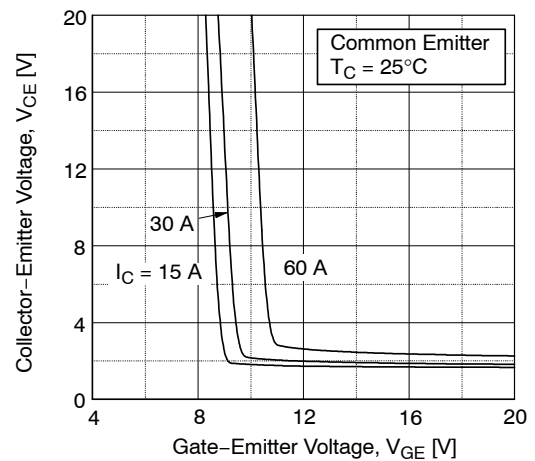

Figure 6. Saturation Voltage vs. Vge

TYPICAL PERFORMANCE CHARACTERISTICS (continued)

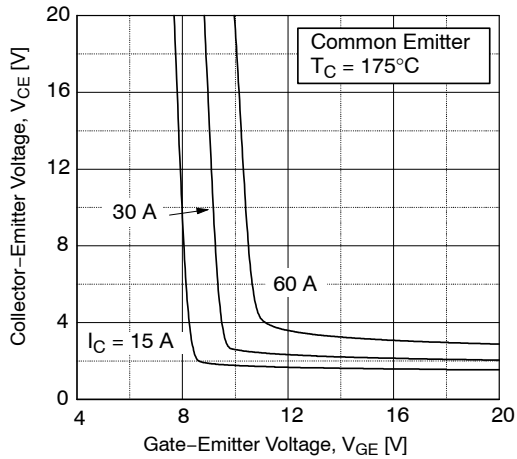

Figure 7. Saturation Voltage vs.  $V_{GE}$

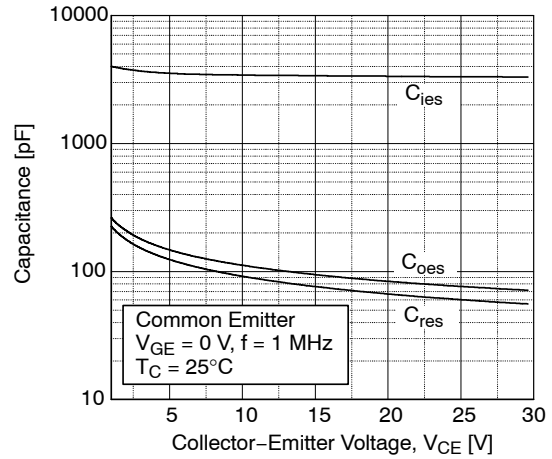

Figure 8. Capacitance Characteristic

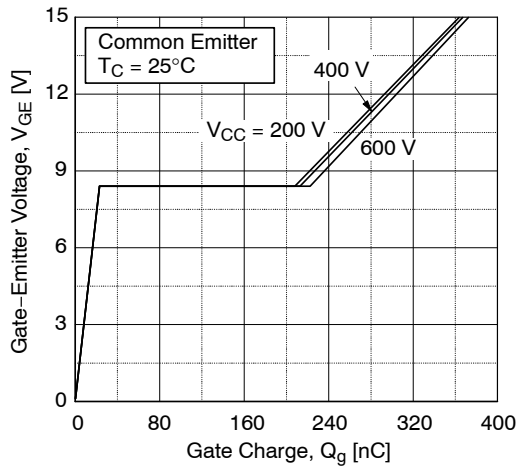

Figure 9. Gate Charge Characteristics

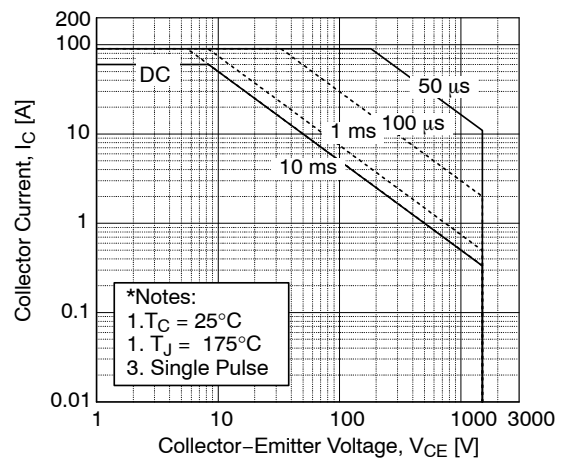

Figure 10. SOA Characteristics

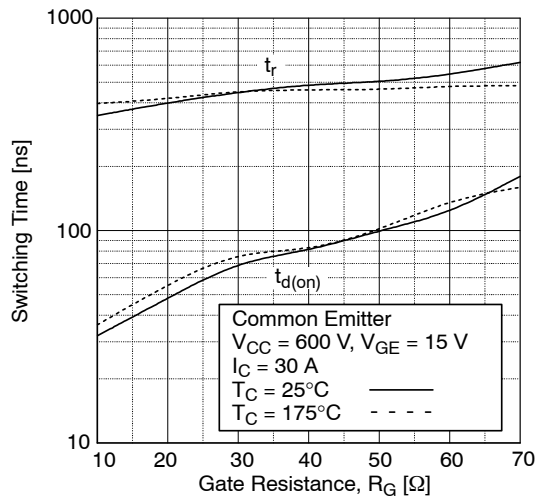

Figure 11. Turn-On Characteristics vs. Gate Resistance

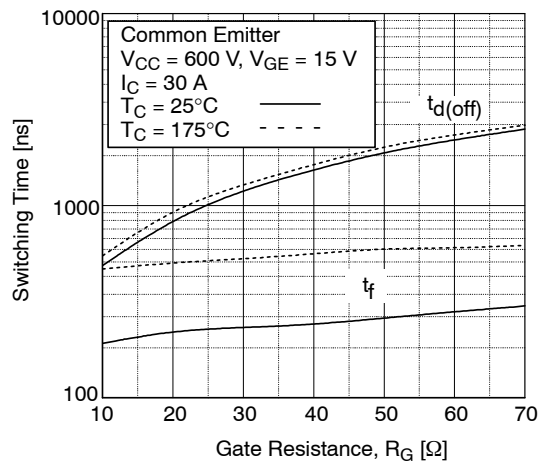

Figure 12. Turn-Off Characteristics vs. Gate Resistance

TYPICAL PERFORMANCE CHARACTERISTICS (continued)

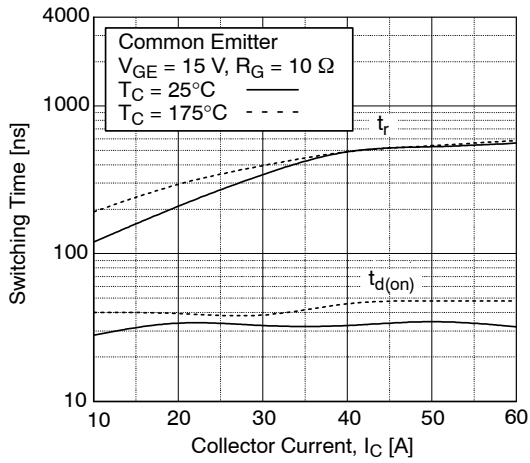

Figure 13. Turn-On Characteristics vs. Collector Current

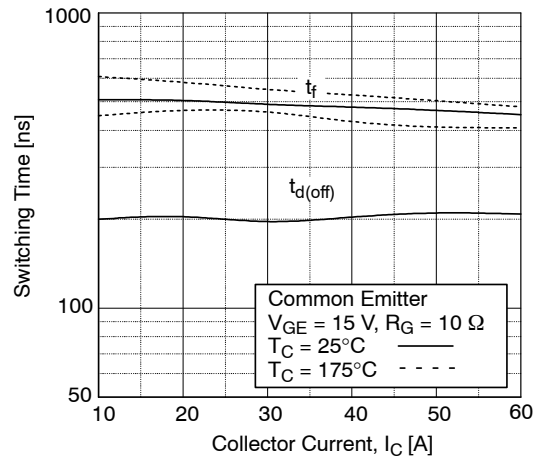

Figure 14. Turn-Off Characteristics vs. Collector Current

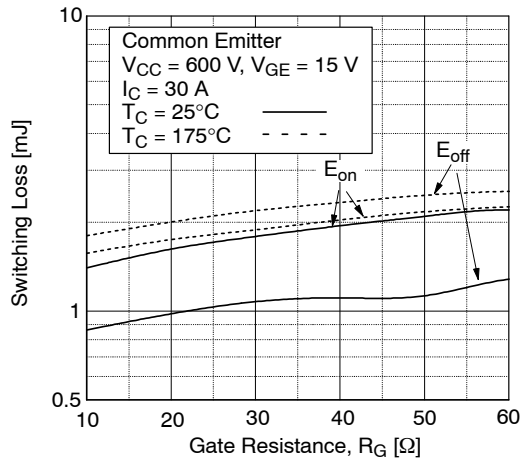

Figure 15. Switching Loss vs. Gate Resistance

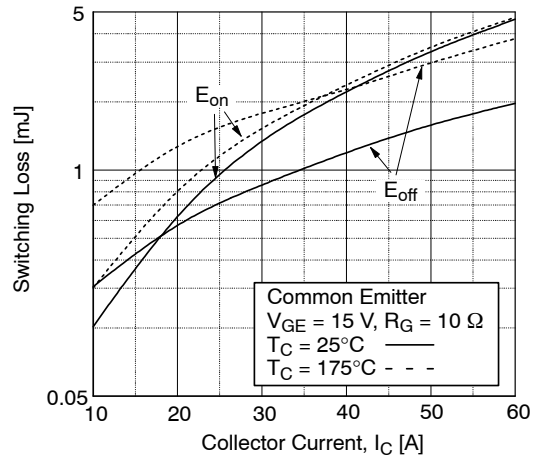

Figure 16. Switching Loss vs. Collector Current

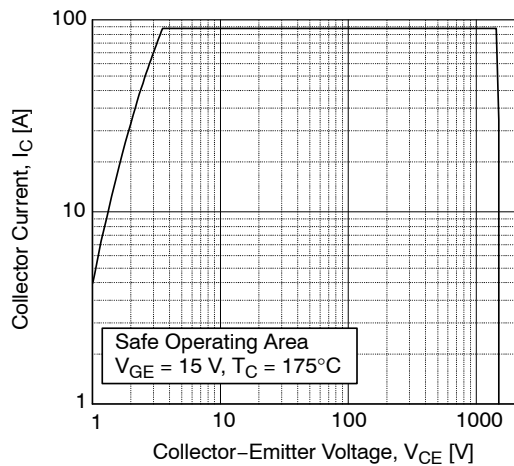

Figure 17. Turn-Off Switching SOA Characteristics

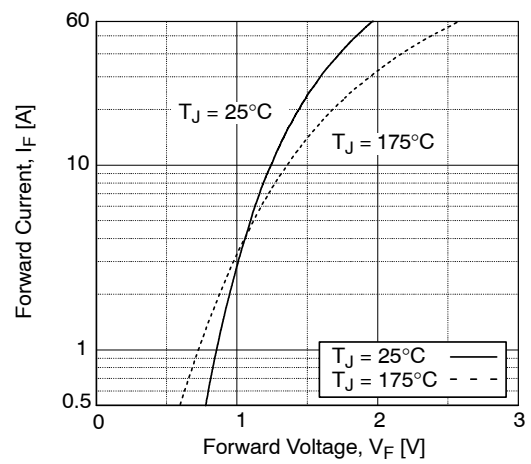

Figure 18. Forward Characteristics

# FGH30S150P

## TYPICAL PERFORMANCE CHARACTERISTICS (continued)

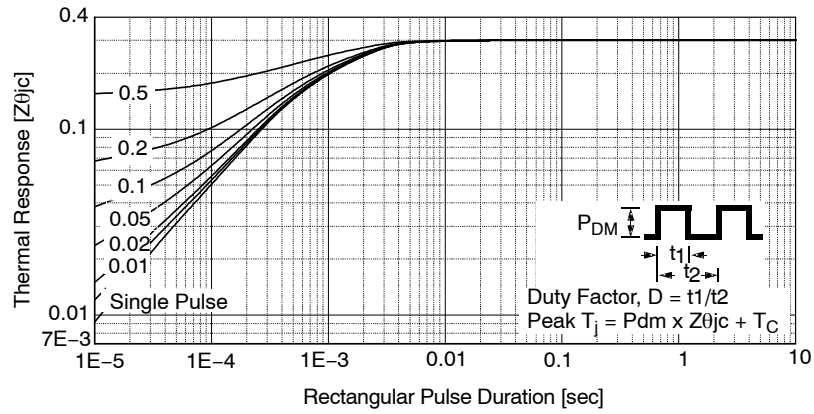

Figure 19. Transient Thermal Impedance of IGBT



**TO-247-3LD SHORT LEAD**  
**CASE 340CK**  
**ISSUE A**

DATE 31 JAN 2019



NOTES: UNLESS OTHERWISE SPECIFIED.

- A. DIMENSIONS ARE EXCLUSIVE OF BURRS, MOLD FLASH, AND TIE BAR EXTRUSIONS.
- B. ALL DIMENSIONS ARE IN MILLIMETERS.
- C. DRAWING CONFORMS TO ASME Y14.5 - 2009.
- D. DIMENSION A1 TO BE MEASURED IN THE REGION DEFINED BY L1.
- E. LEAD FINISH IS UNCONTROLLED IN THE REGION DEFINED BY L1.

**GENERIC MARKING DIAGRAM\***

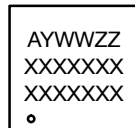

- XXXX = Specific Device Code
- A = Assembly Location
- Y = Year
- WW = Work Week
- ZZ = Assembly Lot Code

\*This information is generic. Please refer to device data sheet for actual part marking. Pb-Free indicator, "G" or microdot "•", may or may not be present. Some products may not follow the Generic Marking.

DIM	MILLIMETERS		
	MIN	NOM	MAX
A	4.58	4.70	4.82
A1	2.20	2.40	2.60
A2	1.40	1.50	1.60
b	1.17	1.26	1.35
b2	1.53	1.65	1.77
b4	2.42	2.54	2.66
c	0.51	0.61	0.71
D	20.32	20.57	20.82
D1	13.08	~	~
D2	0.51	0.93	1.35
E	15.37	15.62	15.87
E1	12.81	~	~
E2	4.96	5.08	5.20
e	~	5.56	~
L	15.75	16.00	16.25
L1	3.69	3.81	3.93
∅P	3.51	3.58	3.65
∅P1	6.60	6.80	7.00
Q	5.34	5.46	5.58
S	5.34	5.46	5.58

<b>DOCUMENT NUMBER:</b>	<b>98AON13851G</b>	Electronic versions are uncontrolled except when accessed directly from the Document Repository. Printed versions are uncontrolled except when stamped "CONTROLLED COPY" in red.
<b>DESCRIPTION:</b>	<b>TO-247-3LD SHORT LEAD</b>	<b>PAGE 1 OF 1</b>

ON Semiconductor and are trademarks of Semiconductor Components Industries, LLC dba ON Semiconductor or its subsidiaries in the United States and/or other countries. ON Semiconductor reserves the right to make changes without further notice to any products herein. ON Semiconductor makes no warranty, representation or guarantee regarding the suitability of its products for any particular purpose, nor does ON Semiconductor assume any liability arising out of the application or use of any product or circuit, and specifically disclaims any and all liability, including without limitation special, consequential or incidental damages. ON Semiconductor does not convey any license under its patent rights nor the rights of others.



**onsemi**, **Onsemi**, and other names, marks, and brands are registered and/or common law trademarks of Semiconductor Components Industries, LLC dba "**onsemi**" or its affiliates and/or subsidiaries in the United States and/or other countries. **onsemi** owns the rights to a number of patents, trademarks, copyrights, trade secrets, and other intellectual property. A listing of **onsemi**'s product/patent coverage may be accessed at [www.onsemi.com/site/pdf/Patent-Marking.pdf](http://www.onsemi.com/site/pdf/Patent-Marking.pdf). **onsemi** reserves the right to make changes at any time to any products or information herein, without notice. The information herein is provided "as-is" and **onsemi** makes no warranty, representation or guarantee regarding the accuracy of the information, product features, availability, functionality, or suitability of its products for any particular purpose, nor does **onsemi** assume any liability arising out of the application or use of any product or circuit, and specifically disclaims any and all liability, including without limitation special, consequential or incidental damages. Buyer is responsible for its products and applications using **onsemi** products, including compliance with all laws, regulations and safety requirements or standards, regardless of any support or applications information provided by **onsemi**. "Typical" parameters which may be provided in **onsemi** data sheets and/or specifications can and do vary in different applications and actual performance may vary over time. All operating parameters, including "Typicals" must be validated for each customer application by customer's technical experts. **onsemi** does not convey any license under any of its intellectual property rights nor the rights of others. **onsemi** products are not designed, intended, or authorized for use as a critical component in life support systems or any FDA Class 3 medical devices or medical devices with a same or similar classification in a foreign jurisdiction or any devices intended for implantation in the human body. Should Buyer purchase or use **onsemi** products for any such unintended or unauthorized application, Buyer shall indemnify and hold **onsemi** and its officers, employees, subsidiaries, affiliates, and distributors harmless against all claims, costs, damages, and expenses, and reasonable attorney fees arising out of, directly or indirectly, any claim of personal injury or death associated with such unintended or unauthorized use, even if such claim alleges that **onsemi** was negligent regarding the design or manufacture of the part. **onsemi** is an Equal Opportunity/Affirmative Action Employer. This literature is subject to all applicable copyright laws and is not for resale in any manner.

## PUBLICATION ORDERING INFORMATION

### LITERATURE FULFILLMENT:

Email Requests to: [orderlit@onsemi.com](mailto:orderlit@onsemi.com)

**onsemi Website:** [www.onsemi.com](http://www.onsemi.com)

### TECHNICAL SUPPORT

**North American Technical Support:**

Voice Mail: 1 800-282-9855 Toll Free USA/Canada

Phone: 011 421 33 790 2910

**Europe, Middle East and Africa Technical Support:**

Phone: 00421 33 790 2910

For additional information, please contact your local Sales Representative

## X-ON Electronics

Largest Supplier of Electrical and Electronic Components

*Click to view similar products for [IGBT Transistors](#) category:*

*Click to view products by [ON Semiconductor](#) manufacturer:*

Other Similar products are found below :

[748152A](#) [APT20GT60BRDQ1G](#) [APT50GT60BRG](#) [NGTB10N60FG](#) [STGFW20V60DF](#) [APT30GP60BG](#) [APT45GR65B2DU30](#)  
[GT50JR22\(STA1ES\)](#) [TIG058E8-TL-H](#) [VS-CPV364M4KPBF](#) [NGTB25N120FL2WAG](#) [NGTG40N120FL2WG](#) [RJH60F3DPQ-A0#T0](#)  
[APT40GR120B2SCD10](#) [APT15GT120BRG](#) [APT20GT60BRG](#) [NGTB75N65FL2WAG](#) [NGTG15N120FL2WG](#) [IXA30RG1200DHGLB](#)  
[IXA40RG1200DHGLB](#) [APT70GR65B2DU40](#) [NTE3320](#) [IHF40N65R5SXXKSA1](#) [APT70GR120J](#) [APT35GP120JDQ2](#)  
[IKZA40N65RH5XKSA1](#) [IKFW75N65ES5XKSA1](#) [IKFW50N65ES5XKSA1](#) [IKFW50N65EH5XKSA1](#) [IKFW40N65ES5XKSA1](#)  
[IKFW60N65ES5XKSA1](#) [IMBG120R090M1HXTMA1](#) [IMBG120R220M1HXTMA1](#) [XD15H120CX1](#) [XD25H120CX0](#) [XP15PJS120CL1B1](#)  
[IGW30N60H3FKSA1](#) [STGWA8M120DF3](#) [IGW08T120FKSA1](#) [IGW75N60H3FKSA1](#) [HGTG40N60B3](#) [FGH60N60SMD\\_F085](#)  
[FGH75T65UPD](#) [STGWA15H120F2](#) [IKA10N60TXKSA1](#) [IHW20N120R5XKSA1](#) [RJH60D2DPP-M0#T2](#) [IKP20N60TXKSA1](#)  
[IHW20N65R5XKSA1](#) [IDW40E65D2FKSA1](#)