



Is Now Part of



**ON Semiconductor®**

To learn more about ON Semiconductor, please visit our website at  
[www.onsemi.com](http://www.onsemi.com)

Please note: As part of the Fairchild Semiconductor integration, some of the Fairchild orderable part numbers will need to change in order to meet ON Semiconductor's system requirements. Since the ON Semiconductor product management systems do not have the ability to manage part nomenclature that utilizes an underscore (\_), the underscore (\_) in the Fairchild part numbers will be changed to a dash (-). This document may contain device numbers with an underscore (\_). Please check the ON Semiconductor website to verify the updated device numbers. The most current and up-to-date ordering information can be found at [www.onsemi.com](http://www.onsemi.com). Please email any questions regarding the system integration to [Fairchild\\_questions@onsemi.com](mailto:Fairchild_questions@onsemi.com).

ON Semiconductor and the ON Semiconductor logo are trademarks of Semiconductor Components Industries, LLC dba ON Semiconductor or its subsidiaries in the United States and/or other countries. ON Semiconductor owns the rights to a number of patents, trademarks, copyrights, trade secrets, and other intellectual property. A listing of ON Semiconductor's product/patent coverage may be accessed at [www.onsemi.com/site/pdf/Patent-Marking.pdf](http://www.onsemi.com/site/pdf/Patent-Marking.pdf). ON Semiconductor reserves the right to make changes without further notice to any products herein. ON Semiconductor makes no warranty, representation or guarantee regarding the suitability of its products for any particular purpose, nor does ON Semiconductor assume any liability arising out of the application or use of any product or circuit, and specifically disclaims any and all liability, including without limitation special, consequential or incidental damages. Buyer is responsible for its products and applications using ON Semiconductor products, including compliance with all laws, regulations and safety requirements or standards, regardless of any support or applications information provided by ON Semiconductor. "Typical" parameters which may be provided in ON Semiconductor data sheets and/or specifications can and do vary in different applications and actual performance may vary over time. All operating parameters, including "Typicals" must be validated for each customer application by customer's technical experts. ON Semiconductor does not convey any license under its patent rights nor the rights of others. ON Semiconductor products are not designed, intended, or authorized for use as a critical component in life support systems or any FDA Class 3 medical devices or medical devices with a same or similar classification in a foreign jurisdiction or any devices intended for implantation in the human body. Should Buyer purchase or use ON Semiconductor products for any such unintended or unauthorized application, Buyer shall indemnify and hold ON Semiconductor and its officers, employees, subsidiaries, affiliates, and distributors harmless against all claims, costs, damages, and expenses, and reasonable attorney fees arising out of, directly or indirectly, any claim of personal injury or death associated with such unintended or unauthorized use, even if such claim alleges that ON Semiconductor was negligent regarding the design or manufacture of the part. ON Semiconductor is an Equal Opportunity/Affirmative Action Employer. This literature is subject to all applicable copyright laws and is not for resale in any manner.

## FIN1019 3.3V LVDS High Speed Differential Driver/Receiver

### General Description

This driver and receiver pair are designed for high speed interconnects utilizing Low Voltage Differential Signaling (LVDS) technology. The driver translates LVTTTL signals to LVDS levels with a typical differential output swing of 350mV and the receiver translates LVDS signals, with a typical differential input threshold of 100mV, into LVTTTL levels. LVDS technology provides low EMI at ultra low power dissipation even at high frequencies. This device is ideal for high speed clock or data transfer.

### Features

- Greater than 400Mbps data rate
- 3.3V power supply operation
- 0.5ns maximum differential pulse skew
- 2.5ns maximum propagation delay
- Low power dissipation
- Power-Off protection
- 100mV receiver input sensitivity
- Fail safe protection open-circuit, shorted and terminated conditions
- Meets or exceeds the TIA/EIA-644 LVDS standard
- Flow-through pinout simplifies PCB layout
- 14-Lead SOIC and TSSOP packages save space

### Ordering Code:

Order Number	Package Number	Package Description
FIN1019M	M14A	14-Lead Small Outline Integrated Circuit (SOIC), JEDEC MS-012, 0.150" Narrow
FIN1019MTC	MTC14	14-Lead Thin Shrink Small Outline Package (TSSOP), JEDEC MO-153, 4.4mm Wide

Devices also available in Tape and Reel. Specify by appending the suffix letter "X" to the ordering code.

### Function Table

Inputs			Outputs	
R <sub>IN+</sub>	R <sub>IN-</sub>	$\overline{RE}$	R <sub>OUT</sub>	
L	H	L	L	
H	L	L	H	
X	X	H	Z	
Fail Safe Condition			L	H
D <sub>IN</sub>		DE	D <sub>OUT+</sub>	D <sub>OUT-</sub>
L		H	L	H
H		H	H	L
X		L	Z	Z
Open-Circuit or Z		H	L	H

H = HIGH Logic Level      L = LOW Logic Level      X = Don't Care  
Z = High Impedance      Fail Safe = Open, Shorted, Terminated

### Connection Diagram

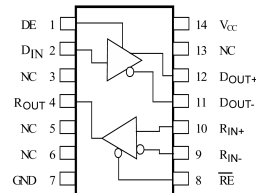

### Pin Descriptions

Pin Name	Description
D <sub>IN</sub>	LVTTTL Data Input
D <sub>OUT+</sub>	Non-inverting LVDS Output
D <sub>OUT-</sub>	Inverting LVDS Output
DE	Driver Enable (LVTTTL, Active HIGH)
R <sub>IN+</sub>	Non-Inverting LVDS Input
R <sub>IN-</sub>	Inverting LVDS Input
R <sub>OUT</sub>	LVTTTL Receiver Output
$\overline{RE}$	Receiver Enable (LVTTTL, Active LOW)
V <sub>CC</sub>	Power Supply
GND	Ground
NC	No Connect

**Absolute Maximum Ratings**(Note 1)

Supply Voltage ( $V_{CC}$ )	-0.5V to +4.6V
LVTTTL DC Input Voltage ( $D_{IN}$ , $DE$ , $\overline{RE}$ )	-0.5V to +6V
LVDS DC Input Voltage ( $R_{IN+}$ , $R_{IN-}$ )	-0.5V to 4.7V
LVTTTL DC Output Voltage ( $R_{OUT}$ )	-0.5V to +6V
LVDS DC Output Voltage ( $D_{OUT+}$ , $D_{OUT-}$ )	-0.5V to 4.7V
LVDS Driver Short Circuit Current ( $I_{OSD}$ )	Continuous
LVTTTL DC Output Current ( $I_O$ )	16 mA
Storage Temperature Range ( $T_{STG}$ )	-65°C to +150°C
Max Junction Temperature ( $T_J$ )	150°C
Lead Temperature ( $T_L$ )	
(Soldering, 10 seconds)	260°C
ESD (Human Body Model)	≥ 6500V
ESD (Machine Model)	≥ 300V

**Recommended Operating Conditions**

Supply Voltage ( $V_{CC}$ )	3.0V to 3.6V
Input Voltage ( $V_{IN}$ )	0 to $V_{CC}$
Magnitude of Differential Voltage ( $ V_{ID} $ )	100 mV to $V_{CC}$
Common-Mode Input Voltage ( $V_{IC}$ )	0.05V to 2.35V
Operating Temperature ( $T_A$ )	-40°C to +85°C

**Note 1:** The "Absolute Maximum Ratings" are those values beyond which damage to the device may occur. The databook specifications should be met, without exception, to ensure that the system design is reliable over its power supply, temperature and output/input loading variables. Fairchild does not recommend operation of circuits outside databook specification.

**DC Electrical Characteristics**

Over supply voltage and operating temperature ranges, unless otherwise specified

Symbol	Parameter	Test Conditions	Min	Typ (Note 2)	Max	Units
<b>LVDS Differential Driver Characteristics</b>						
$V_{OD}$	Output Differential Voltage		250	350	450	mV
$\Delta V_{OD}$	$V_{OD}$ Magnitude Change from Differential LOW-to-HIGH	$R_L = 100\Omega$ , See Figure 1			25	mV
$V_{OS}$	Offset Voltage		1.125	1.25	1.375	V
$\Delta V_{OS}$	Offset Magnitude Change from Differential LOW-to-HIGH				25	mV
$I_{OZD}$	Disabled Output Leakage Current	$V_{OUT} = V_{CC}$ or GND, $DE = 0V$			±20	μA
$I_{OFF}$	Power Off Output Current	$V_{CC} = 0V$ , $V_{OUT} = 0V$ or 3.6V			±20	μA
$I_{OS}$	Short Circuit Output Current	$V_{OUT} = 0V$ , $DE = V_{CC}$ $V_{OD} = 0V$ , $DE = V_{CC}$			-8 ±8	mA
<b>LVTTTL Driver Characteristics</b>						
$V_{OH}$	Output HIGH Voltage	$I_{OH} = -100 \mu A$ , $\overline{RE} = 0V$ , See Figure 6 and Table 1	$V_{CC} - 0.2$			V
		$I_{OH} = -8 mA$ , $\overline{RE} = 0V$ , $V_{ID} = 400 mV$ $V_{ID} = 400 mV$ , $V_{IC} = 1.2V$ , see Figure 6	2.4			V
$V_{OL}$	Output LOW Voltage	$I_{OL} = 100 \mu A$ , $\overline{RE} = 0V$ , $V_{ID} = -400 mV$ See Figure 6 and Table 1			0.2	V
		$I_{OL} = -8 mA$ , $\overline{RE} = 0V$ , $V_{ID} = -400 mV$ $V_{ID} = -400 mV$ , $V_{IC} = 1.2V$ , see Figure 6			0.5	V
$I_{OZ}$	Disabled Output Leakage Current	$V_{OUT} = V_{CC}$ or GND, $\overline{RE} = V_{CC}$			±20	μA
<b>LVDS Receiver Characteristics</b>						
$V_{TH}$	Differential Input Threshold HIGH	See Figure 6 and Table 1			100	mV
$V_{TL}$	Differential Input Threshold LOW	See Figure 6 and Table 1	-100			mV
$I_{IN}$	Input Current	$V_{IN} = 0V$ or $V_{CC}$			±20	μA
$I_{I(OFF)}$	Power-OFF Input Current	$V_{CC} = 0V$ , $V_{IN} = 0V$ or 3.6V			±20	μA
<b>LVTTTL Driver and Control Signals Characteristics</b>						
$V_{IH}$	Input HIGH Voltage		2.0		$V_{CC}$	V
$V_{IL}$	Input LOW Voltage		GND		0.8	V
$I_{IN}$	Input Current	$V_{IN} = 0V$ or $V_{CC}$			±20	μA
$I_{I(OFF)}$	Power-OFF Input Current	$V_{CC} = 0V$ , $V_{IN} = 0V$ or 3.6V			±20	μA
$V_{IK}$	Input Clamp Voltage	$I_{IK} = -18 mA$	-1.5			V

DC Electrical Characteristics (Continued)						
Device Characteristics						
I <sub>CC</sub>	Power Supply Current	Driver Enabled, Driver Load: R <sub>L</sub> = 100 Ω Receiver Disabled, No Receiver Load			12.5	mA
		Driver Enabled, Driver Load: R <sub>L</sub> = 100 Ω, Receiver Enabled, (R <sub>IN+</sub> = 1V and R <sub>IN-</sub> = 1.4V) or (R <sub>IN+</sub> = 1.4V and R <sub>OUT-</sub> = 1V)			12.5	mA
		Driver Disabled, Receiver Enabled, (R <sub>IN+</sub> = 1V and R <sub>IN-</sub> = 1.4V) or (R <sub>IN+</sub> = 1.4V and R <sub>IN-</sub> = 1V)			7.0	mA
		Driver Disabled, Receiver Disabled			7.0	mA
C <sub>IN</sub>	Input Capacitance	Any LVTTTL or LVDS Input		4		pF
C <sub>OUT</sub>	Output Capacitance	Any LVTTTL or LVDS Output		6		pF
<b>Note 2:</b> All typical values are at T <sub>A</sub> = 25°C and with V <sub>CC</sub> = 3.3V.						
AC Electrical Characteristics						
Over supply voltage and operating temperature ranges, unless otherwise specified						
Symbol	Parameter	Test Conditions	Min	Typ (Note 3)	Max	Units
Driver Timing Characteristics						
t <sub>PLHD</sub>	Differential Propagation Delay LOW-to-HIGH	R <sub>L</sub> = 100 Ω, C <sub>L</sub> = 10 pF, See Figure 2 and Figure 3	0.5		1.5	ns
t <sub>PHLD</sub>	Differential Propagation Delay HIGH-to-LOW		0.5		1.5	ns
t <sub>TLHD</sub>	Differential Output Rise Time (20% to 80%)		0.4		1.0	ns
t <sub>THLD</sub>	Differential Output Fall Time (80% to 20%)		0.4		1.0	ns
t <sub>SK(P)</sub>	Pulse Skew  t <sub>PLH</sub> - t <sub>PHL</sub>				0.5	ns
t <sub>SK(PP)</sub>	Part-to-Part Skew (Note 4)	R <sub>L</sub> = 100Ω, C <sub>L</sub> = 10 pF, See Figure 4 and Figure 5			1.0	ns
t <sub>ZHD</sub>	Differential Output Enable Time from Z to HIGH				5.0	ns
t <sub>ZLD</sub>	Differential Output Enable Time from Z to LOW				5.0	ns
t <sub>HZD</sub>	Differential Output Disable Time from HIGH to Z				5.0	ns
t <sub>LZD</sub>	Differential Output Disable Time from LOW to Z				5.0	ns
Receiver Timing Characteristics						
t <sub>PLH</sub>	Propagation Delay LOW-to-HIGH	V <sub>ID</sub>   = 400 mV, C <sub>L</sub> = 10 pF, See Figure 6 and Figure 7	0.9		2.5	ns
t <sub>PHL</sub>	Propagation Delay HIGH-to-LOW		0.9		2.5	ns
t <sub>TLH</sub>	Output Rise time (20% to 80%)		0.5			ns
t <sub>THL</sub>	Output Fall time (80% to 20%)		0.5			ns
t <sub>SK(P)</sub>	Pulse Skew  t <sub>PLH</sub> - t <sub>PHL</sub>				0.5	ns
t <sub>SK(PP)</sub>	Part-to-Part Skew (Note 4)	R <sub>L</sub> = 500 Ω, C <sub>L</sub> = 10 pF, See Figure 8			1.0	ns
t <sub>ZH</sub>	LVTTTL Output Enable Time from Z to HIGH				5.0	ns
t <sub>ZL</sub>	LVTTTL Output Enable Time from Z to LOW				5.0	ns
t <sub>HZ</sub>	LVTTTL Output Disable Time from HIGH to Z				5.0	ns
t <sub>LZ</sub>	LVTTTL Output Disable Time from LOW to Z				5.0	ns
<b>Note 3:</b> All typical values are at T <sub>A</sub> = 25°C and with V <sub>CC</sub> = 5V.						
<b>Note 4:</b> t <sub>SK(PP)</sub> is the magnitude of the difference in propagation delay times between any specified terminals of two devices switching in the same direction (either LOW-to-HIGH or HIGH-to-LOW) when both devices operate with the same supply voltage, same temperature, and have identical test circuits.						

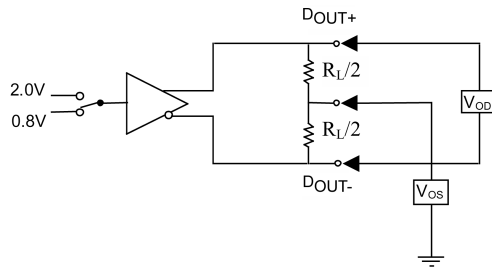
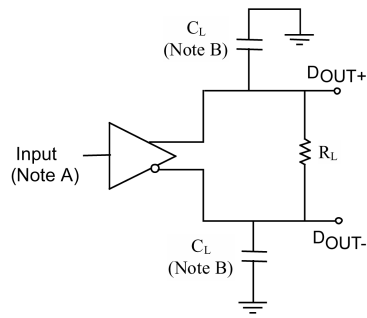

FIGURE 1. Differential Driver DC Test Circuit



Note A: Input pulses have frequency = 10 MHz,  $t_R$  or  $t_F = 2$  ns

Note B:  $C_L$  includes all probe and fixture capacitances

FIGURE 2. Differential Driver Propagation Delay and Transition Time Test Circuit

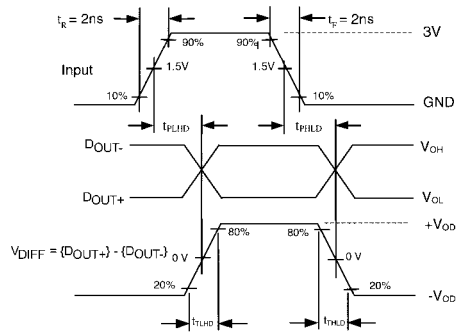
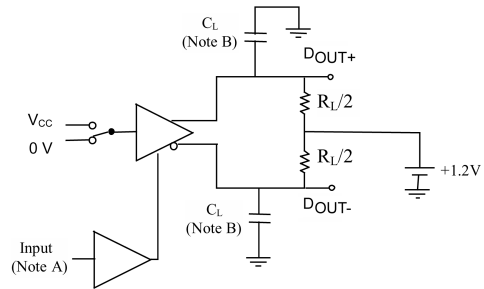

FIGURE 3. AC Waveforms for Differential Driver



Note B: Input pulses have the frequency = 10 MHz,  $t_R$  or  $t_F = 2$  ns

Note A:  $C_L$  includes all probe and fixture capacitances

FIGURE 4. Differential Driver Enable and Disable Test Circuit

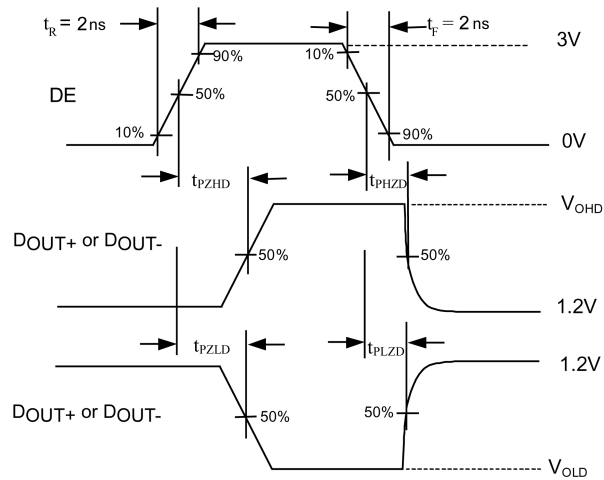
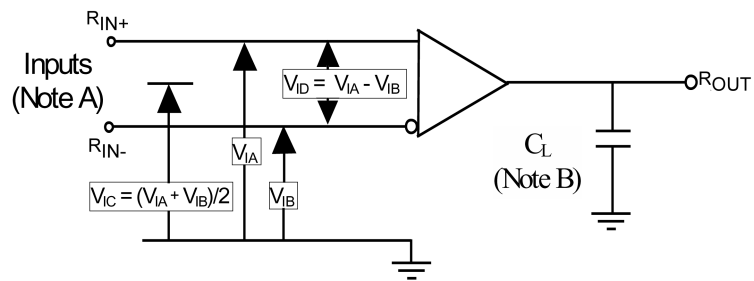

FIGURE 5. Enable and Disable AC Waveforms



**Note A:** Input pulses have frequency = 10 MHz,  $t_R$  or  $t_F$  = 1 ns

**Note B:**  $C_L$  includes all probe and fixture capacitance

**FIGURE 6. Differential Receiver Voltage Definitions and Propagation Delay and Transition Time Test Circuit**

**TABLE 1. Receiver Minimum and Maximum Input Threshold Test Voltages**

Applied Voltages (V)		Resulting Differential Input Voltage (mV)	Resulting Common Mode Input Voltage (V)
$V_{IA}$	$V_{IB}$		
1.25	1.15	100	1.2
1.15	1.25	-100	1.2
2.4	2.3	100	2.35
2.3	2.4	-100	2.35
0.1	0	100	0.05
0	0.1	-100	0.05
1.5	0.9	600	1.2
0.9	1.5	-600	1.2
2.4	1.8	600	2.1
1.8	2.4	-600	2.1
0.6	0	600	0.3
0	0.6	-600	0.3

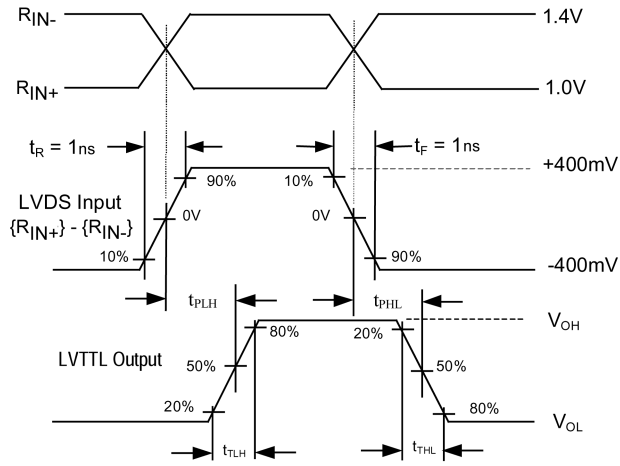
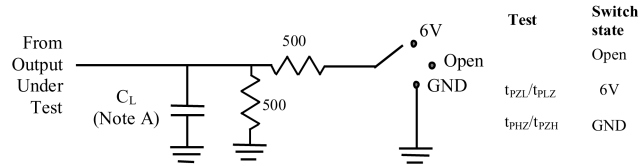

FIGURE 7. LVDS Input to LVTTTL Output AC Waveforms

Test Circuit for LVTTTL Outputs



Voltage Waveforms Enable and Disable Times

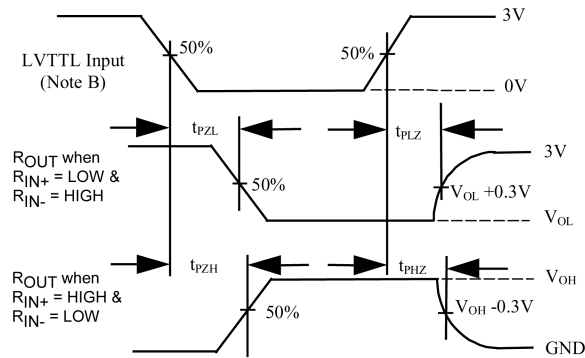

FIGURE 8. LVTTTL Outputs Test Circuit and AC Waveforms

## DC / AC Typical Performance Curves

### Drivers

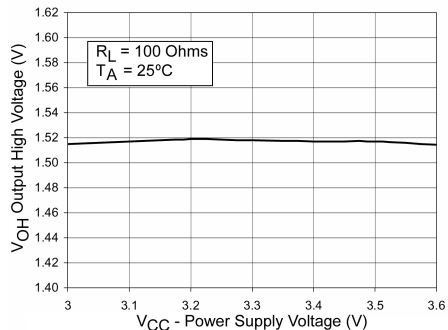

FIGURE 9. Output High Voltage vs. Power Supply Voltage

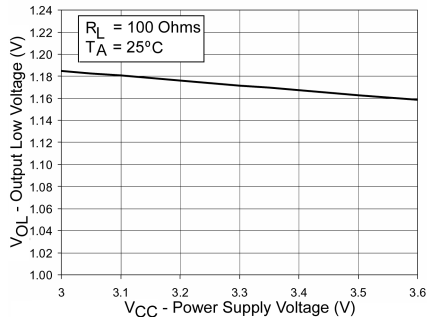

FIGURE 10. Output Low Voltage vs. Power Supply Voltage

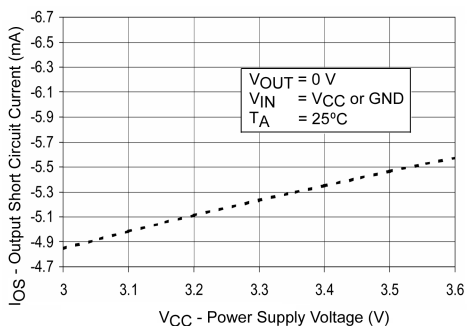

FIGURE 11. Output Short Circuit Current vs. Power Supply Voltage

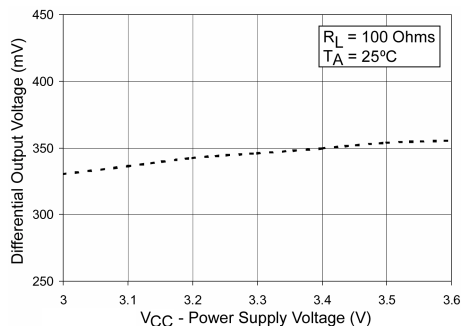

FIGURE 12. Differential Output Voltage vs. Power Supply Voltage

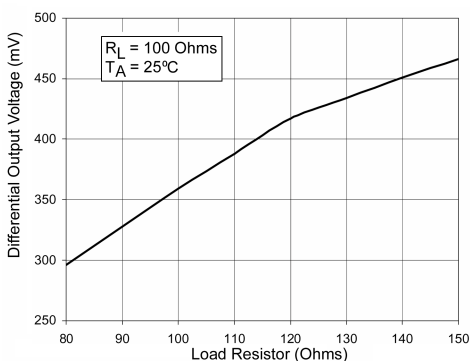

FIGURE 13. Differential Output Voltage vs. Load Resistor

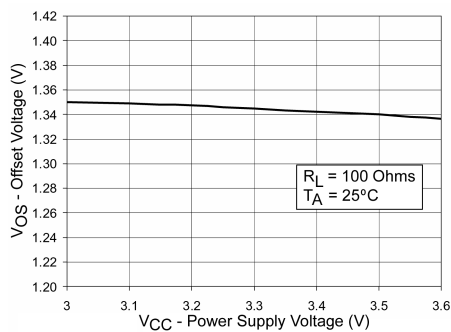

FIGURE 14. Offset Voltage vs. Power Supply Voltage



DC / AC Typical Performance Curves (Continued)

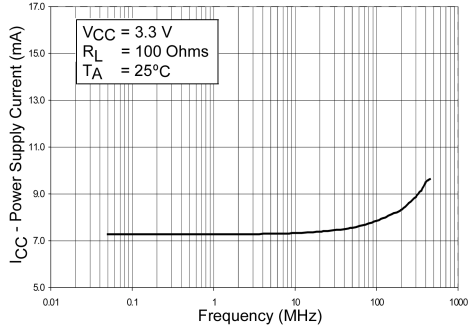

FIGURE 15. Power Supply Current vs. Frequency

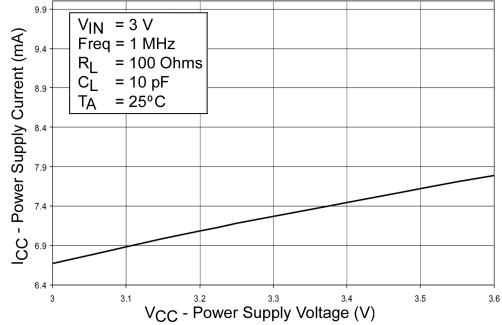

FIGURE 16. Power Supply Current vs. Power Supply Voltage

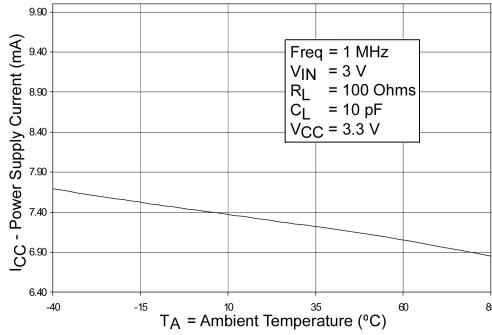

FIGURE 17. Power Supply Current vs. Ambient Temperature

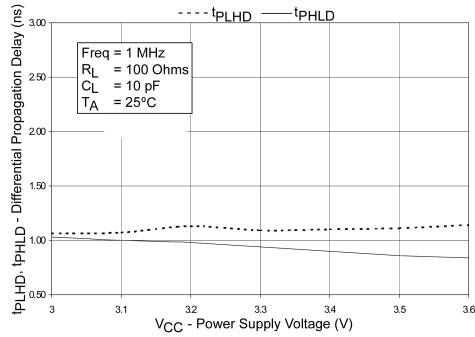

FIGURE 18. Differential Propagation Delay vs. Power Supply

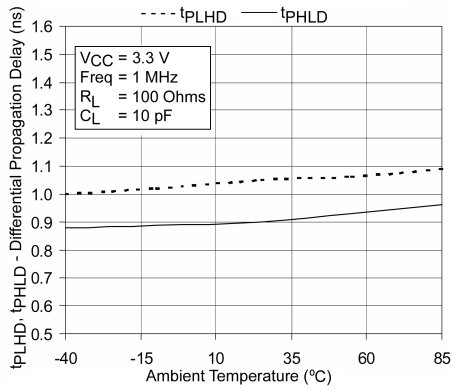

FIGURE 19. Differential Propagation Delay vs. Ambient Temperature

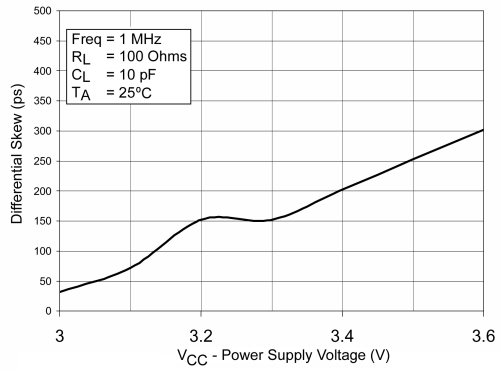

FIGURE 20. Differential Skew ( $t_{PLH} - t_{PHL}$ ) vs. Power Supply Voltage

DC / AC Typical Performance Curves (Continued)

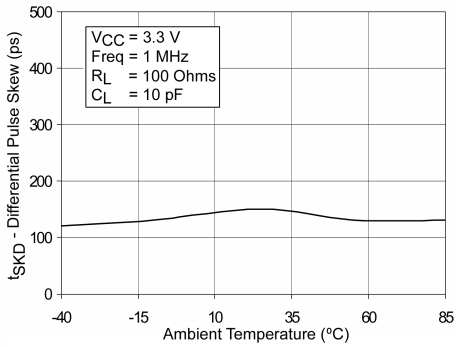

FIGURE 21. Differential Pulse Skew ( $t_{pLH} - t_{pHL}$ ) vs. Ambient Temperature

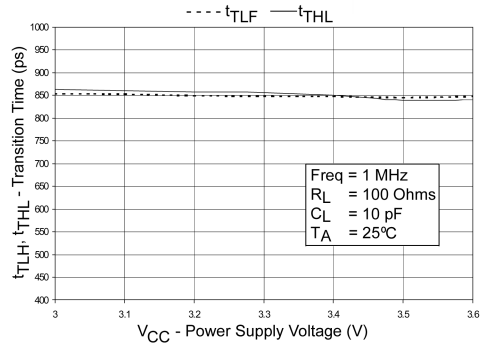

FIGURE 22. Transition Time vs. Power Supply Voltage

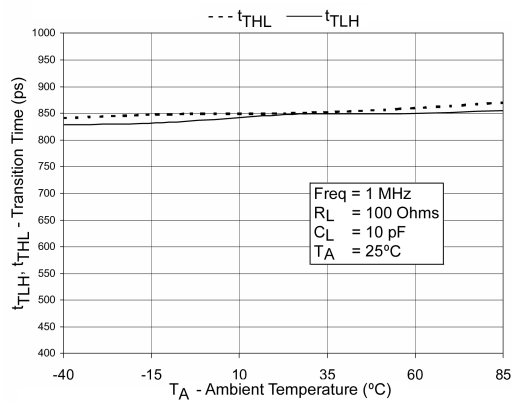

FIGURE 23. Transition Times vs. Ambient Temperature

DC / AC Typical Performance Curves

Receiver

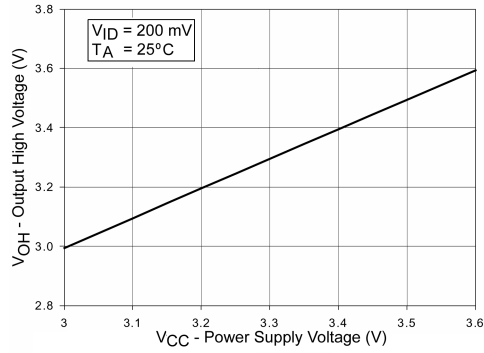

FIGURE 24. Output High Voltage vs. Power Supply Voltage

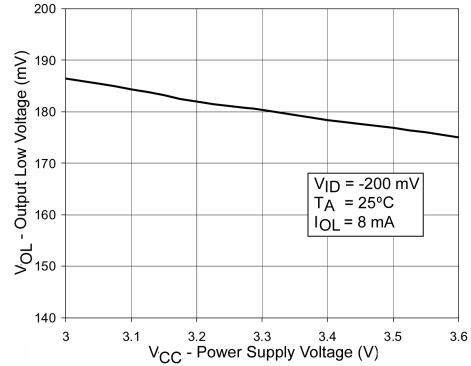

FIGURE 25. Output Low Voltage vs. Power Supply Voltage

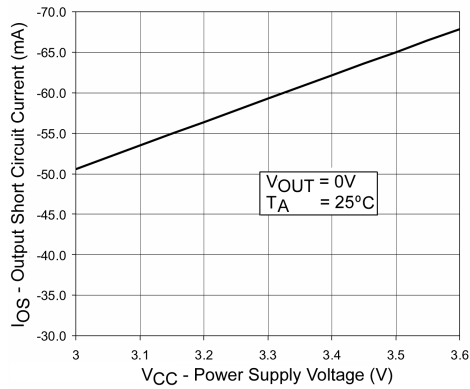

FIGURE 26. Output Short Circuit Current vs. Power Supply Voltage

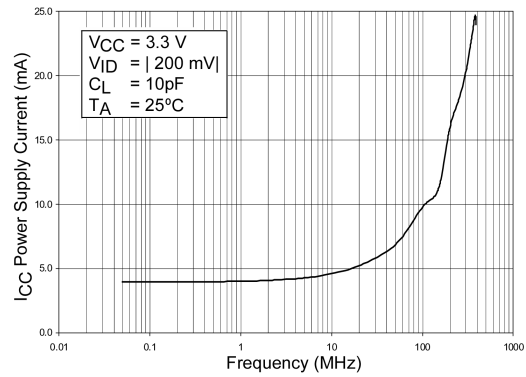

FIGURE 27. Power Supply Current vs. Frequency

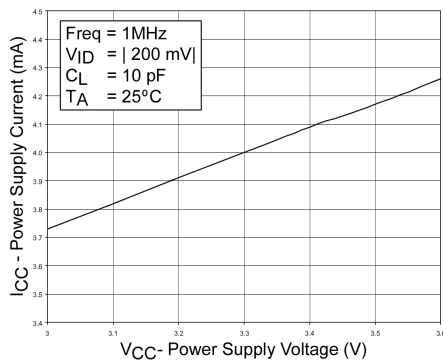

FIGURE 28. Power Supply Current vs. Power Supply Voltage

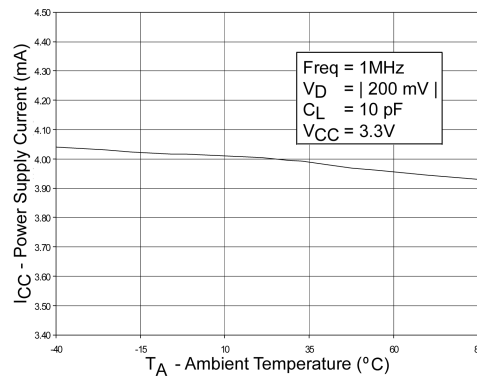

FIGURE 29. Power Supply Current vs. Ambient Temperature

DC / AC Typical Performance Curves (Continued)

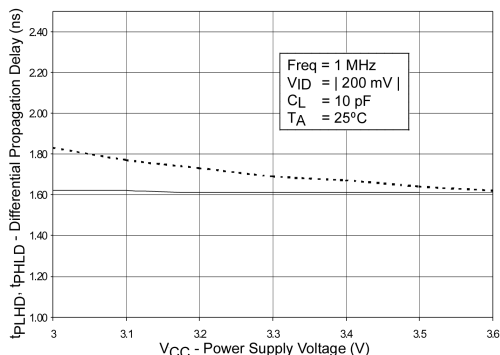

FIGURE 30. Differential Propagation Delay vs. Power Supply Voltage

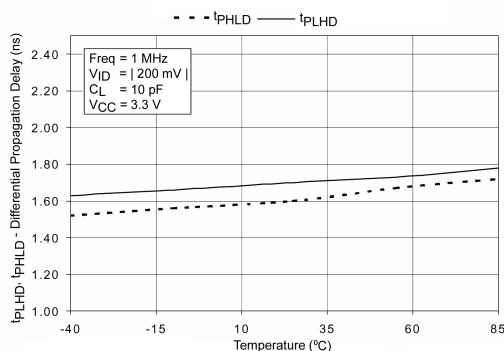

FIGURE 31. Differential Propagation Delay vs. Ambient Temperature

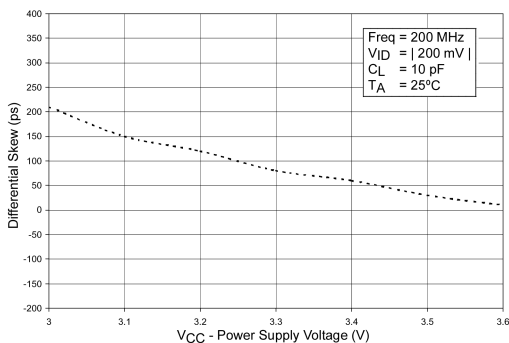

FIGURE 32. Differential Skew ( $t_{PHL} - t_{PLH}$ ) vs. Power Supply Voltage

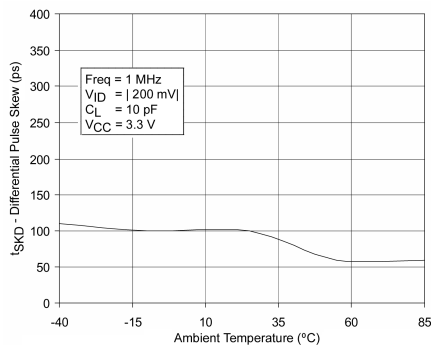

FIGURE 33. Differential Skew ( $t_{PLH} - t_{PHL}$ ) vs. Ambient Temperature

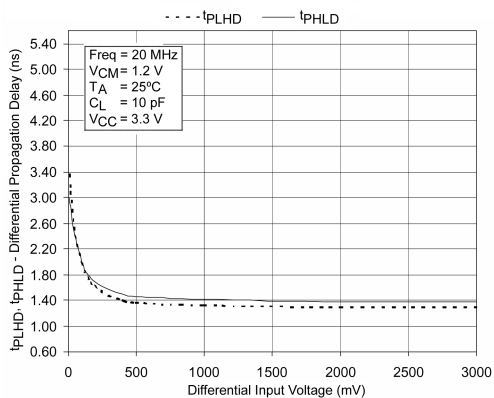

FIGURE 34. Differential Propagation Delay vs. Differential Input Voltage

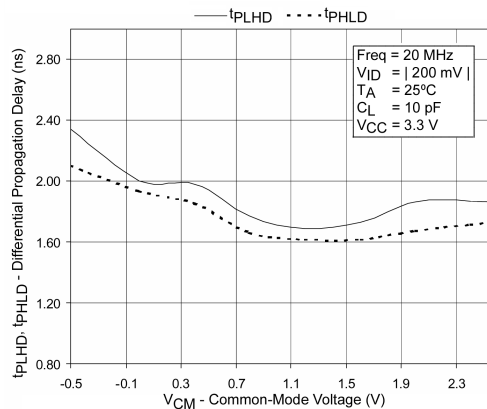

FIGURE 35. Differential Propagation Delay vs. Common-Mode Voltage

DC / AC Typical Performance Curves (Continued)

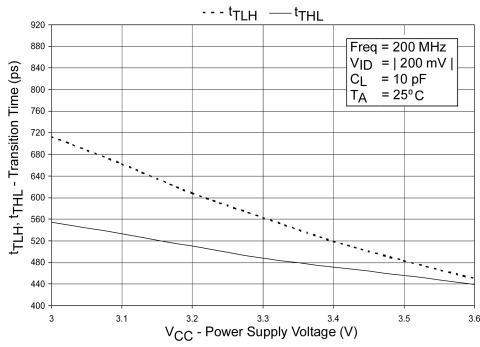

FIGURE 36. Transition Time vs. Power Supply Voltage

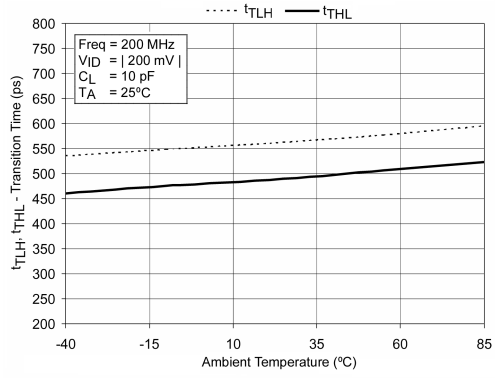

FIGURE 37. Transition Time vs. Ambient Temperature

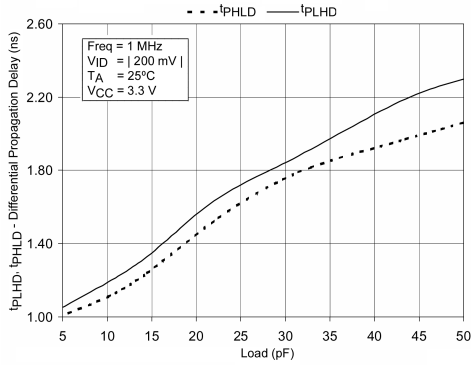

FIGURE 38. Differential Propagation Delay vs. Load

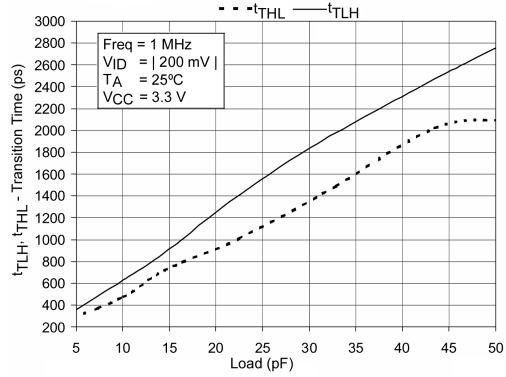
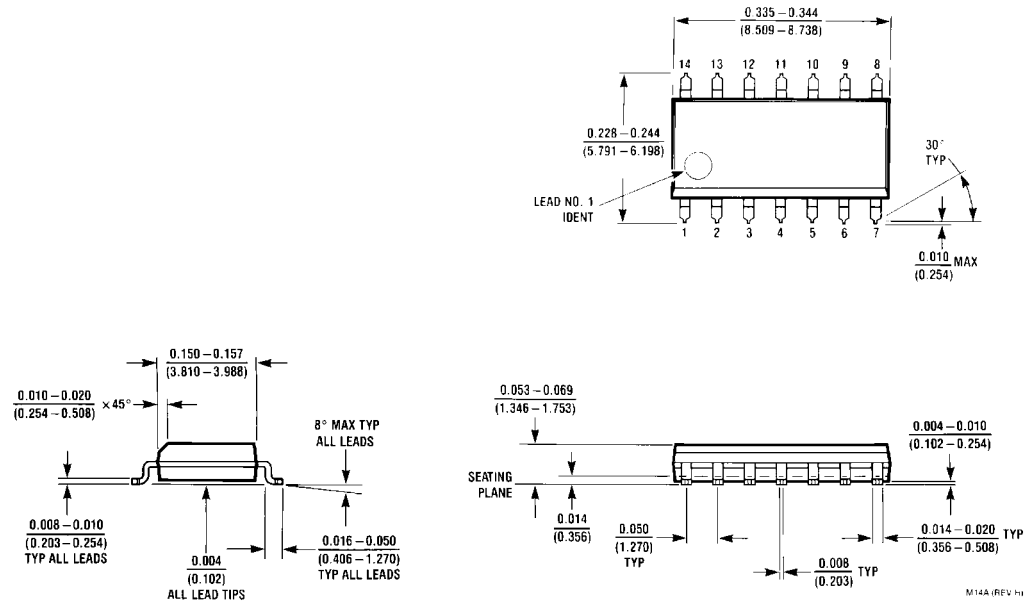

FIGURE 39. Transition Time vs. Load

**Physical Dimensions** inches (millimeters) unless otherwise noted



**14-Lead Small Outline Integrated Circuit (SOIC), JEDEC MS-012, 0.150" Narrow  
Package Number M14A**

M14A (REV. H)

**Physical Dimensions** inches (millimeters) unless otherwise noted (Continued)

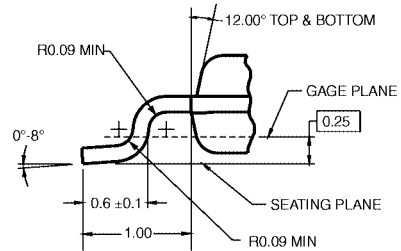
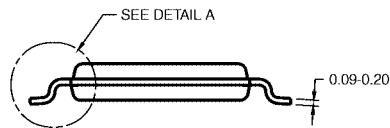
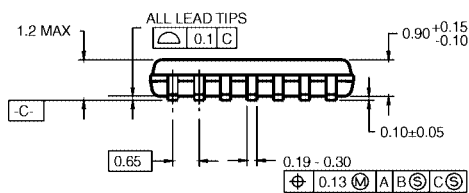
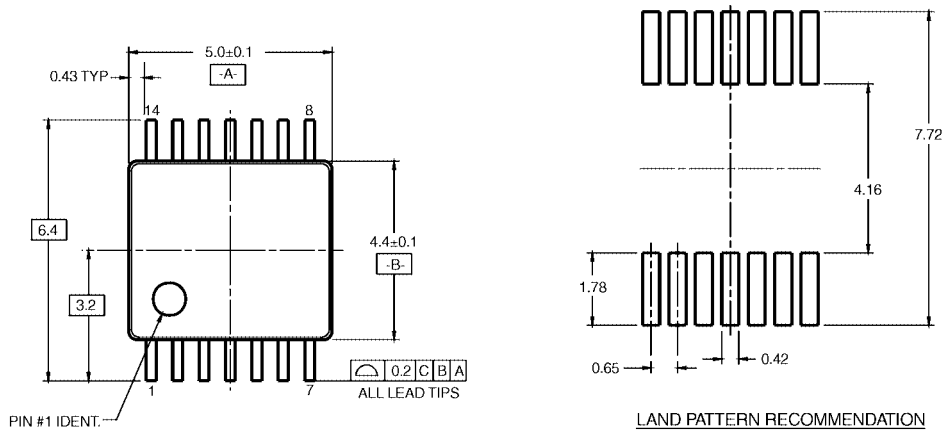

- NOTES:
- CONFORMS TO JEDEC REGISTRATION MO-153, VARIATION AB, REF NOTE 6, DATE 7/93.
  - DIMENSIONS ARE IN MILLIMETERS.
  - DIMENSIONS ARE EXCLUSIVE OF BURRS, MOLD FLASH, AND TIE BAR EXTRUSIONS.
  - DIMENSIONS AND TOLERANCES PER ANSI Y14.5M, 1982.

MTC14RevC3

DETAIL A

**14-Lead Thin Shrink Small Outline Package (TSSOP), JEDEC MO-153, 4.4mm Wide Package Number MTC14**

Fairchild does not assume any responsibility for use of any circuitry described, no circuit patent licenses are implied and Fairchild reserves the right at any time without notice to change said circuitry and specifications.

**LIFE SUPPORT POLICY**

FAIRCHILD'S PRODUCTS ARE NOT AUTHORIZED FOR USE AS CRITICAL COMPONENTS IN LIFE SUPPORT DEVICES OR SYSTEMS WITHOUT THE EXPRESS WRITTEN APPROVAL OF THE PRESIDENT OF FAIRCHILD SEMICONDUCTOR CORPORATION. As used herein:

- Life support devices or systems are devices or systems which, (a) are intended for surgical implant into the body, or (b) support or sustain life, and (c) whose failure to perform when properly used in accordance with instructions for use provided in the labeling, can be reasonably expected to result in a significant injury to the user.
- A critical component in any component of a life support device or system whose failure to perform can be reasonably expected to cause the failure of the life support device or system, or to affect its safety or effectiveness.

[www.fairchildsemi.com](http://www.fairchildsemi.com)

ON Semiconductor and  are trademarks of Semiconductor Components Industries, LLC dba ON Semiconductor or its subsidiaries in the United States and/or other countries. ON Semiconductor owns the rights to a number of patents, trademarks, copyrights, trade secrets, and other intellectual property. A listing of ON Semiconductor's product/patent coverage may be accessed at [www.onsemi.com/site/pdf/Patent-Marking.pdf](http://www.onsemi.com/site/pdf/Patent-Marking.pdf). ON Semiconductor reserves the right to make changes without further notice to any products herein. ON Semiconductor makes no warranty, representation or guarantee regarding the suitability of its products for any particular purpose, nor does ON Semiconductor assume any liability arising out of the application or use of any product or circuit, and specifically disclaims any and all liability, including without limitation special, consequential or incidental damages. Buyer is responsible for its products and applications using ON Semiconductor products, including compliance with all laws, regulations and safety requirements or standards, regardless of any support or applications information provided by ON Semiconductor. "Typical" parameters which may be provided in ON Semiconductor data sheets and/or specifications can and do vary in different applications and actual performance may vary over time. All operating parameters, including "Typicals" must be validated for each customer application by customer's technical experts. ON Semiconductor does not convey any license under its patent rights nor the rights of others. ON Semiconductor products are not designed, intended, or authorized for use as a critical component in life support systems or any FDA Class 3 medical devices or medical devices with a same or similar classification in a foreign jurisdiction or any devices intended for implantation in the human body. Should Buyer purchase or use ON Semiconductor products for any such unintended or unauthorized application, Buyer shall indemnify and hold ON Semiconductor and its officers, employees, subsidiaries, affiliates, and distributors harmless against all claims, costs, damages, and expenses, and reasonable attorney fees arising out of, directly or indirectly, any claim of personal injury or death associated with such unintended or unauthorized use, even if such claim alleges that ON Semiconductor was negligent regarding the design or manufacture of the part. ON Semiconductor is an Equal Opportunity/Affirmative Action Employer. This literature is subject to all applicable copyright laws and is not for resale in any manner.

## PUBLICATION ORDERING INFORMATION

### LITERATURE FULFILLMENT:

Literature Distribution Center for ON Semiconductor  
19521 E. 32nd Pkwy, Aurora, Colorado 80011 USA  
**Phone:** 303-675-2175 or 800-344-3860 Toll Free USA/Canada  
**Fax:** 303-675-2176 or 800-344-3867 Toll Free USA/Canada  
**Email:** [orderlit@onsemi.com](mailto:orderlit@onsemi.com)

**N. American Technical Support:** 800-282-9855 Toll Free  
USA/Canada  
**Europe, Middle East and Africa Technical Support:**  
Phone: 421 33 790 2910  
**Japan Customer Focus Center**  
Phone: 81-3-5817-1050

**ON Semiconductor Website:** [www.onsemi.com](http://www.onsemi.com)  
**Order Literature:** <http://www.onsemi.com/orderlit>  
For additional information, please contact your local  
Sales Representative



## X-ON Electronics

Largest Supplier of Electrical and Electronic Components

*Click to view similar products for [Buffers & Line Drivers](#) category:*

*Click to view products by [ON Semiconductor](#) manufacturer:*

Other Similar products are found below :

[LXV200-024SW](#) [74AUP2G34FW3-7](#) [HEF4043BP](#) [PI74FCT3244L](#) [MC74HCT365ADTR2G](#) [Le87401NQC](#) [Le87402MQC](#) [028192B](#)  
[042140C](#) [051117G](#) [070519XB](#) [NL17SZ07P5T5G](#) [NLU1GT126AMUTCG](#) [74AUP1G17FW5-7](#) [74LVC2G17FW4-7](#) [CD4502BE](#) [5962-](#)  
[8982101PA](#) [5962-9052201PA](#) [74LVC1G125FW4-7](#) [NL17SH17P5T5G](#) [NL17SH125P5T5G](#) [NLV37WZ07USG](#) [RHRXH162244K1](#)  
[74AUP1G34FW5-7](#) [74AUP1G07FW5-7](#) [74LVC2G126RA3-7](#) [NLX2G17CMUTCG](#) [74LVCE1G125FZ4-7](#) [Le87501NQC](#) [74AUP1G126FW5-](#)  
[7](#) [TC74HC4050AP\(F\)](#) [74LVCE1G07FZ4-7](#) [NLX3G16DMUTCG](#) [NLX2G06AMUTCG](#) [NLVVHC1G50DFT2G](#) [NLU2G17AMUTCG](#)  
[LE87100NQC](#) [LE87290YQC](#) [LE87290YQCT](#) [LE87511NQC](#) [LE87511NQCT](#) [LE87557NQC](#) [LE87557NQCT](#) [LE87614MQC](#)  
[LE87614MQCT](#) [74AUP1G125FW5-7](#) [NLU2G16CMUTCG](#) [MC74LCX244MN2TWG](#) [NLV74VHC125DTR2G](#) [NL17SG126DFT2G](#)