



Is Now Part of



ON Semiconductor®

To learn more about ON Semiconductor, please visit our website at
www.onsemi.com

Please note: As part of the Fairchild Semiconductor integration, some of the Fairchild orderable part numbers will need to change in order to meet ON Semiconductor's system requirements. Since the ON Semiconductor product management systems do not have the ability to manage part nomenclature that utilizes an underscore (_), the underscore (_) in the Fairchild part numbers will be changed to a dash (-). This document may contain device numbers with an underscore (_). Please check the ON Semiconductor website to verify the updated device numbers. The most current and up-to-date ordering information can be found at www.onsemi.com. Please email any questions regarding the system integration to Fairchild_questions@onsemi.com.

ON Semiconductor and the ON Semiconductor logo are trademarks of Semiconductor Components Industries, LLC dba ON Semiconductor or its subsidiaries in the United States and/or other countries. ON Semiconductor owns the rights to a number of patents, trademarks, copyrights, trade secrets, and other intellectual property. A listing of ON Semiconductor's product/patent coverage may be accessed at www.onsemi.com/site/pdf/Patent-Marking.pdf. ON Semiconductor reserves the right to make changes without further notice to any products herein. ON Semiconductor makes no warranty, representation or guarantee regarding the suitability of its products for any particular purpose, nor does ON Semiconductor assume any liability arising out of the application or use of any product or circuit, and specifically disclaims any and all liability, including without limitation special, consequential or incidental damages. Buyer is responsible for its products and applications using ON Semiconductor products, including compliance with all laws, regulations and safety requirements or standards, regardless of any support or applications information provided by ON Semiconductor. "Typical" parameters which may be provided in ON Semiconductor data sheets and/or specifications can and do vary in different applications and actual performance may vary over time. All operating parameters, including "Typicals" must be validated for each customer application by customer's technical experts. ON Semiconductor does not convey any license under its patent rights nor the rights of others. ON Semiconductor products are not designed, intended, or authorized for use as a critical component in life support systems or any FDA Class 3 medical devices or medical devices with a same or similar classification in a foreign jurisdiction or any devices intended for implantation in the human body. Should Buyer purchase or use ON Semiconductor products for any such unintended or unauthorized application, Buyer shall indemnify and hold ON Semiconductor and its officers, employees, subsidiaries, affiliates, and distributors harmless against all claims, costs, damages, and expenses, and reasonable attorney fees arising out of, directly or indirectly, any claim of personal injury or death associated with such unintended or unauthorized use, even if such claim alleges that ON Semiconductor was negligent regarding the design or manufacture of the part. ON Semiconductor is an Equal Opportunity/Affirmative Action Employer. This literature is subject to all applicable copyright laws and is not for resale in any manner.



FL663

Primary-Side-Regulation PWM Controller for LED Illumination

Features

- Low Standby Power: < 30 mW
- High-Voltage Startup
- Few External Component Counts
- Constant-Voltage (CV) and Constant-Current (CC) Control without Secondary-Feedback Circuitry
- Green-Mode: Linearly-Decreasing PWM Frequency with Cycle skipping.
- Fixed PWM Frequency at 50 kHz and 33 kHz with Proprietary Frequency Hopping to Solve EMI Problems
- Peak-Current-Mode Control in CV Mode
- Cycle-by-Cycle Current Limiting
- V_{DD} Over-Voltage Protection (OVP)
- V_{DD} Under-Voltage Lockout (UVLO)
- Adjustable Brownout Detector
- Gate Output Maximum Voltage Clamped at 15 V
- Thermal Shutdown (TSD) Protection
- Available in the 8-Lead SOIC Package

Description

This third-generation Primary-Side-Regulation (PSR) and highly integrated PWM controller provides features to enhance the performance of LED illumination.

The proprietary topology, TRUECURRENT[®], enables precise CC regulation and simplified circuit for LED illumination applications. The result is lower-cost and smaller LED lighting compared to a conventional design or a linear transformer.

To minimize standby power consumption, the proprietary green-mode function provides off-time modulation to linearly decrease PWM frequency with cycle skipping under light-load conditions. Green mode assists the power supply in meeting the power conservation requirements.

By using the FL663, LED illumination can be implemented with few external components and minimized cost.



Figure 1. 8-Lead SOIC

Applications

- LED Illumination
- Battery chargers for cellular phones, cordless phones, PDA, digital cameras, power tools

Ordering Information

Part Number	Operating Temperature Range	Top Mark	Package	Packing Method
FL663MX	-40°C to +125°C	FL663	8-Lead, Small-Outline Package (SOIC-8)	Tape & Reel

Marking Information

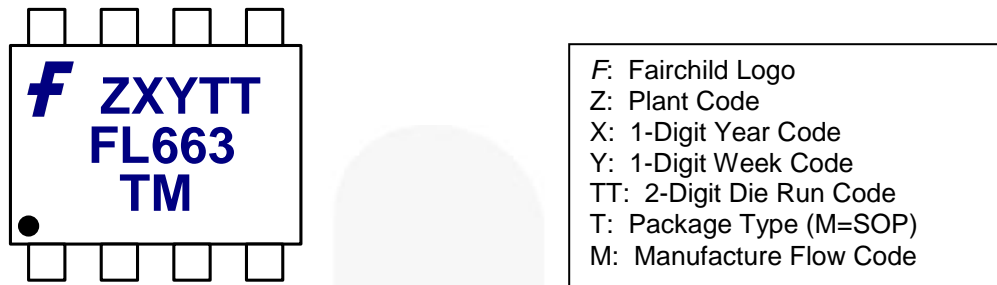

Figure 4. Top Mark

Pin Configuration

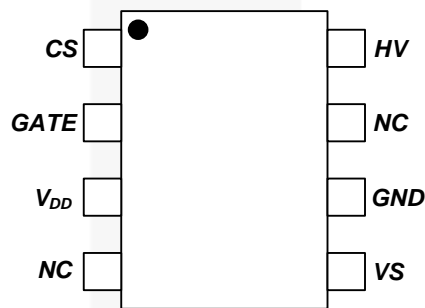

Figure 5. Pin Configuration

Pin Definitions

Pin #	Name	Description
1	CS	Current Sense. This pin connects a current-sense resistor to detect the MOSFET current for peak-current-mode control in CV Mode and provides the output-current regulation in CC Mode.
2	GATE	PWM Signal Output. This pin uses the internal totem-pole output driver to drive the power MOSFET. It is internally clamped below 15 V.
3	V _{DD}	Power Supply. IC operating current and MOSFET driving current are supplied using this pin. This pin is connected to an external V _{DD} capacitor of typically 10 μF. The threshold voltages for startup and turn-off are 16 V and 7.5 V, respectively. The operating current is lower than 5 mA.
4	NC	No Connect. This pin is connected to GND or no connection. Does not connect any voltage source.
5	VS	Voltage Sense. This pin detects the output voltage information and discharge time based on voltage of auxiliary winding.
6	GND	Ground
7	NC	No Connect
8	HV	High Voltage. This pin connects to DC link capacitor for high-voltage startup. This pin is connected to an external startup resistor of typically 100 kΩ.

Absolute Maximum Ratings

Stresses exceeding the absolute maximum ratings may damage the device. The device may not function or be operable above the recommended operating conditions and stressing the parts to these levels is not recommended. In addition, extended exposure to stresses above the recommended operating conditions may affect device reliability. The absolute maximum ratings are stress ratings only.

Symbol	Parameter	Min.	Max.	Unit
V _{HV}	HV Pin Input Voltage		500	V
V _{VDD}	DC Supply Voltage ⁽¹⁾		30	V
V _{VS}	VS Pin Input Voltage	-0.3	6.0	V
V _{CS}	CS Pin Input Voltage	-0.3	6.0	V
P _D	Power Dissipation (T _A <50°C)		660	mW
θ _{JA}	Thermal Resistance, (Junction-to-Air)		+150	°C/W
θ _{JC}	Thermal Resistance, (Junction-to-Case)		39	°C/W
T _J	Junction Temperature	-40	+150	°C
T _{STG}	Storage Temperature Range	-55	+150	°C
T _L	Lead Temperature (Wave Soldering or IR, 10 Seconds)		+260	°C
ESD ⁽²⁾	Electrostatic Discharge Capability	Human Body Model (Except HV Pin), JEDEC-JESD22_A114	5.0	kV
		Charged Device Model (Except HV Pin), JEDEC-ESD22_C101	2.0	

Notes:

- All voltage values, except differential voltages, are given with respect to GND pin.
- All Pins: HBM=1 kV, CDM=1.25 kV

Recommended Operating Conditions

The Recommended Operating Conditions table defines the conditions for actual device operation. Recommended operating conditions are specified to ensure optimal performance to the datasheet specifications. Fairchild does not recommend exceeding them or designing to Absolute Maximum Ratings.

Symbol	Parameter	Min.	Typ.	Max.	Unit
V _{DD}	Continuous Operating Voltage			25	V
T _A	Operation Ambient Temperature	-40		+125	°C

Electrical Characteristics

$V_{DD}=15\text{ V}$ and $T_A=-40^{\circ}\text{C}\sim 125^{\circ}\text{C}$ unless otherwise noted.

Symbol	Parameter	Conditions	Min.	Typ.	Max.	Unit		
V_{DD} Section								
V_{DD-ON}	Turn-On Threshold Voltage		15	16	17	V		
V_{DD-OFF}	Turn-Off Threshold Voltage		7.0	7.5	8.0	V		
I_{DD-OP}	Operating Current			3.2	5.0	mA		
$I_{DD-GREEN}$	Green Mode Operating Supply Current			0.95	1.20	mA		
V_{DD-OVP}	V_{DD} Over-Voltage Protection Level		27	28	29	V		
$t_{D-VDDOVP}$	V_{DD} OVP Debounce Time		90	200	350	μs		
High Voltage (HV) Section								
V_{HV-MIN}	Minimum Startup Voltage on HV Pin ⁽³⁾				50	V		
I_{HV}	Supply Current Drawn from Pin HV	$V_{DL}=100\text{ V}$	1.0	2.0	5.0	mA		
I_{HV-LC}	Leakage Current after Startup	HV=500 V, $V_{DD}=V_{DD-OFF} + 1\text{ V}$		0.5	3.0	μA		
Oscillator Section								
f_{OSC}	Normal Frequency	Center Frequency	$> V_O * 0.5, T_A=25^{\circ}\text{C}$	47	50	53	kHz	
		Frequency Hopping Range		± 1.5	± 2.0	± 2.5		
	Protection Frequency ⁽⁴⁾	Center Frequency		$< V_O * 0.5, T_A=25^{\circ}\text{C}$		33		
		Frequency Hopping Range				± 1.3		
$V_{F-JUM-53}$	Frequency Jumping Point	$50\text{ kHz} \rightarrow 33\text{ kHz}, V_S^{(3)}$	1.05		1.25	1.55	V	
$V_{F-JUM-35}$		$33\text{ kHz} \rightarrow 50\text{ kHz}, V_S$	1.28		1.50	1.75	V	
$f_{OSC-N-MIN}$	Minimum Frequency at No-Load		260	385	500	Hz		
$f_{OSC-CM-MIN}$	Minimum Frequency at CCM		7	12	17	kHz		
$V_{S-F-SKIPH}$	COMV Level for High Cycle Skipping Period Change ⁽³⁾			1.14		V		
$V_{S-F-SKIPL}$	COMV level for Low Cycle Skipping period Change ⁽³⁾			0.80		V		
ΔCOMV_{SKIP}	Cycle Skipping Period COMV Hysteresis Voltage			0.34		V		
$T_{SKIP-CV}$	Cycle Skipping Period ⁽³⁾	$V_{S-F-SKIPH} < \text{COMV} < V_N$		240		ms		
		$V_{S-F-SKIPL} > \text{COMV}$		160				
f_{DV}	Frequency Variation vs. V_{DD} Deviation ⁽³⁾	$V_{DD}=10\sim 25\text{ V}$		1	2	%		
f_{DT}	Frequency Variation vs. Temperature Deviation				15	%		
Voltage Sense (V_s) Section								
V_R	Reference Voltage for Error AMPs	$T_A=25^{\circ}\text{C}$	2.475	2.500	2.525	V		
V_N	Green-Mode Starting Voltage on EAV	$f_{OSC}=2\text{ kHz}$		2.5		V		
V_G	Green-Mode Ending Voltage on EAV	$f_{OSC}=1\text{ kHz}$		0.5		V		
$V_{BIAS-COMV}$	Adaptive Bias Voltage Dominated by $V_{COMV}^{(3)}$	$R_{VS}=20\text{ k}\Omega$		1.4		V		

Continued on the following page...

Electrical Characteristics

$V_{DD}=15\text{ V}$ and $T_A=-40^{\circ}\text{C}\sim 125^{\circ}\text{C}$ unless otherwise noted.

Symbol	Parameter		Conditions	Min.	Typ.	Max.	Unit
I_{tc}	IC Bias Current			7.3	10.0	12.7	μA
I_{VS-BO}	Brownout Detection Current ⁽⁴⁾				175		μA
I_{VS-MIN}	Minimum VS Current ⁽⁴⁾		90 V_{AC} , Heavy Load		227		μA
I_{VS-MAX}	Maximum VS Current ⁽⁴⁾		264 V_{AC} , No Load		721		μA
t_{DIS_MIN}	Minimum Discharging Time	Normal Operation ⁽⁴⁾	$f_{OSC}=50\text{ kHz}$		0.65		μs
		Protection Area	$f_{OSC}=33\text{ kHz}$	2.0	2.6	4.0	
Current Sense (CS) Section							
t_{PD}	Propagation Delay to GATE Output				90	200	ns
t_{MIN-N}	Minimum On Time at No-Load		$V_{COMR}=1\text{ V}$	800	975	1150	ns
V_{TH}	Threshold Voltage for Current Limit			0.75	0.80	0.85	V
V_{TL}	Threshold Voltage on V_S Pin Smaller than 0.5 V				0.25		V
GATE Section							
DCY_{MAX}	Maximum Duty Cycle			60	75	85	%
V_{OL}	Output Voltage Low		$V_{DD}=20\text{ V}$, Gate Sinks 10 mA			1.5	V
V_{OH}	Output Voltage High		$V_{DD}=8\text{ V}$, Gate Sources 1 mA	5			V
t_r	Rising Time		$C_L=1\text{ nF}$		200	250	ns
t_f	Falling Time		$C_L=1\text{ nF}$		60	100	ns
V_{CLAMP}	Output Clamp Voltage		$V_{DD}=25\text{ V}$		15	18	V
Thermal Shutdown (TSD) Section							
TSD	Thermal Shutdown Temperature ⁽⁴⁾			+140			$^{\circ}\text{C}$
TSD_{HYS}	Thermal Shutdown Hysteresis ⁽⁴⁾				+15		$^{\circ}\text{C}$

Notes:

3. Guaranteed by design.
4. These parameters, although guaranteed, are not 100% tested in production.

Typical Performance Characteristics

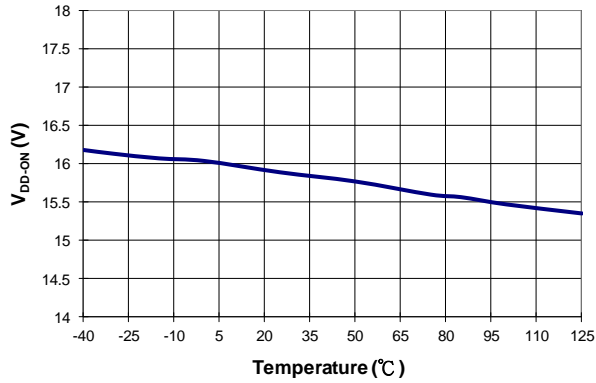

Figure 6. V_{DD-ON} vs. Temperature

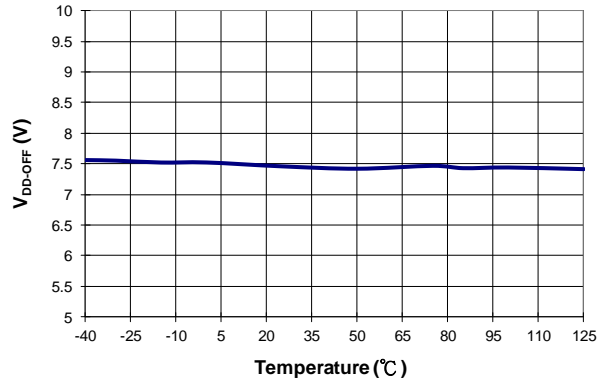

Figure 7. V_{DD-OFF} vs. Temperature

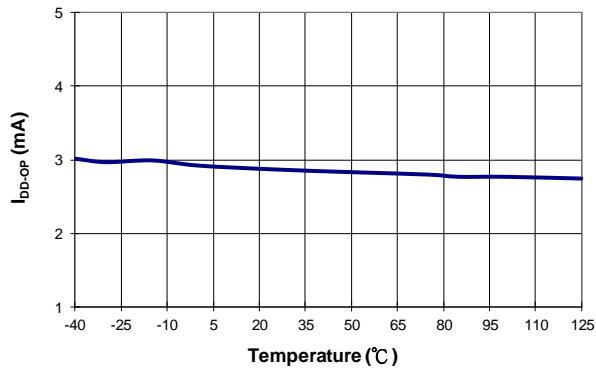

Figure 8. I_{DD-OP} vs. Temperature

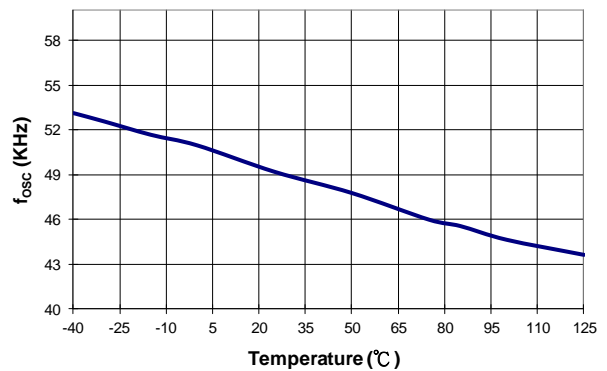

Figure 9. f_{OSC} vs. Temperature

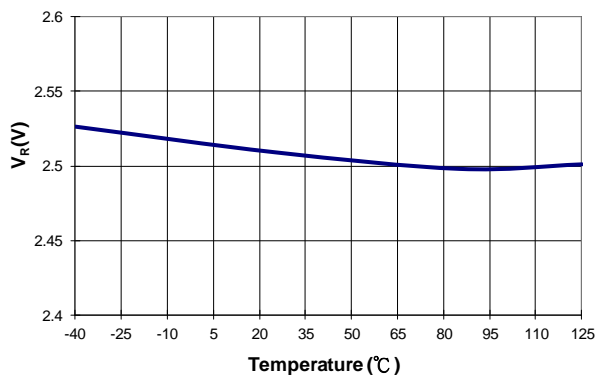

Figure 10. V_R vs. Temperature

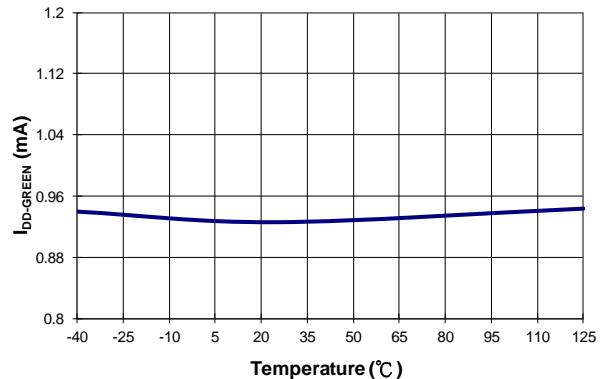

Figure 11. I_{DD-GREEN} vs. Temperature

Typical Performance Characteristics (Continued)

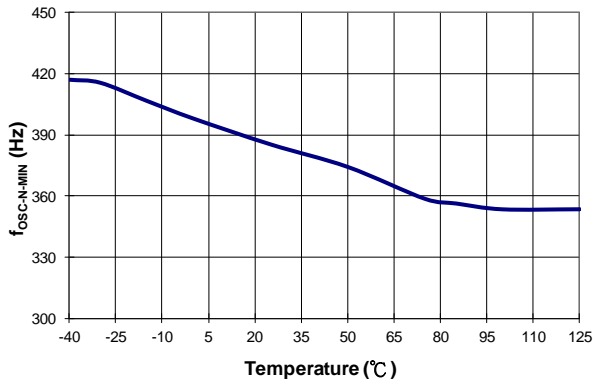

Figure 12. $f_{OSC-N-MIN}$ vs. Temperature

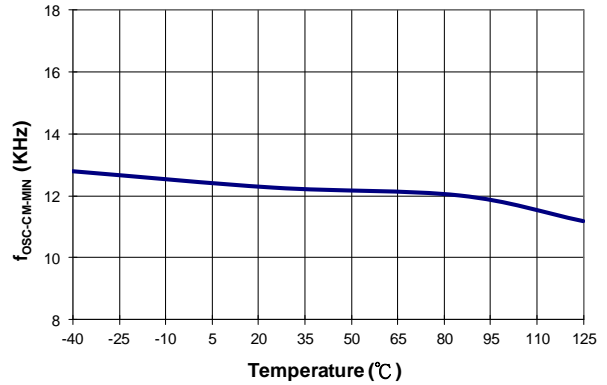

Figure 13. $f_{OSC-CM-MIN}$ vs. Temperature

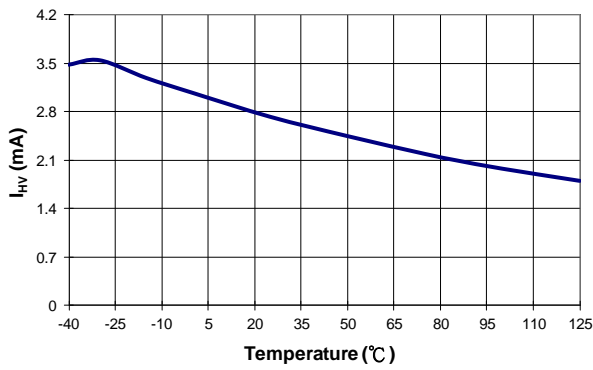

Figure 14. I_{HV} vs. Temperature

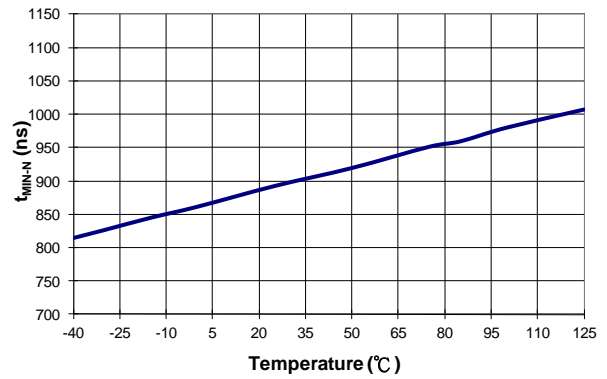

Figure 15. t_{MIN-N} vs. Temperature

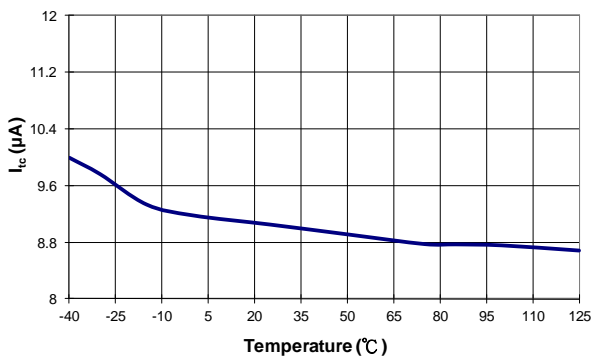

Figure 16. I_{IC} vs. Temperature

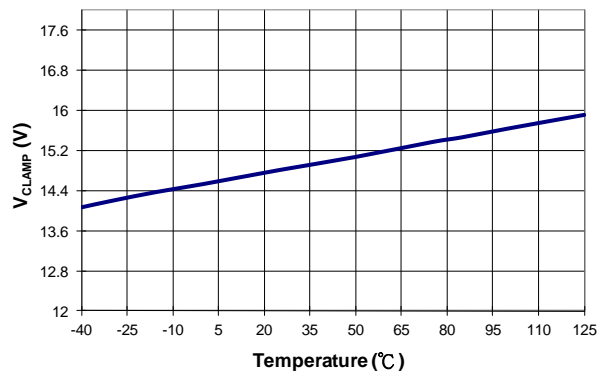

Figure 17. V_{CLAMP} vs. Temperature

Typical Performance Characteristics (Continued)

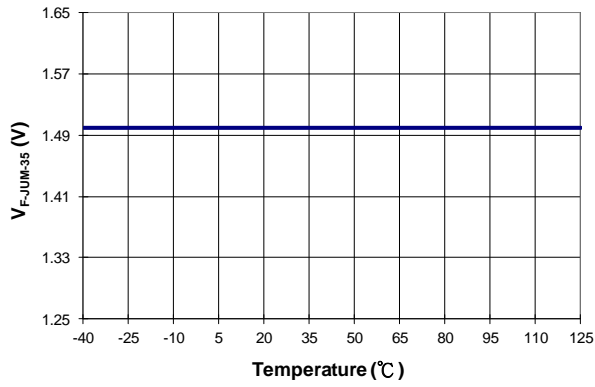

Figure 18. $V_{F-JUM-35}$ vs. Temperature

Functional Description

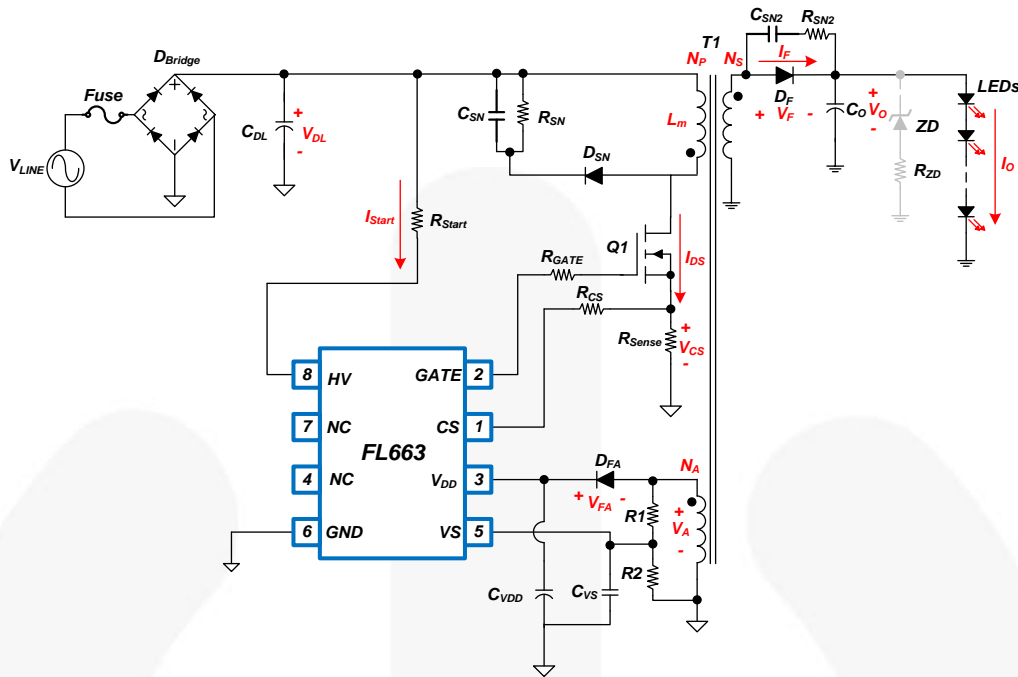

Figure 19. Basic Circuit of a PSR Flyback Converter for LED Illumination

Figure 19 shows the basic circuit diagram of a primary-side regulated flyback converter with typical waveforms shown in Figure 20. Generally, Discontinuous Conduction Mode (DCM) operation is preferred for primary-side regulation since it allows better output regulation.

The operation principles of DCM flyback converter are as follows:

Stage I

During the MOSFET on time (t_{ON}), input voltage (V_{DC}) is applied across the primary-side inductor (L_m). Then MOSFET current (I_{DS}) increases linearly from zero to the peak value (I_{PK}). During this time, the energy is drawn from the input and stored in the inductor.

Stage II

When the MOSFET (Q1) is turned off, the energy stored in the inductor forces the rectifier diode (D_F) to be turned on. While the diode is conducting, the output voltage (V_O), together with diode forward-voltage drop (V_F), is applied across the secondary-side inductor and the diode current (I_F) decreases linearly from the peak value ($I_{PK} \times N_P/N_S$) to zero. At the end of inductor current discharge time (t_{DIS}), all the energy stored in the inductor has been delivered to the output.

Stage III

When the diode current reaches zero, the transformer auxiliary winding voltage (V_A) begins to oscillate by the resonance between the primary-side inductor (L_m) and the effective capacitor loaded across MOSFET (Q1).

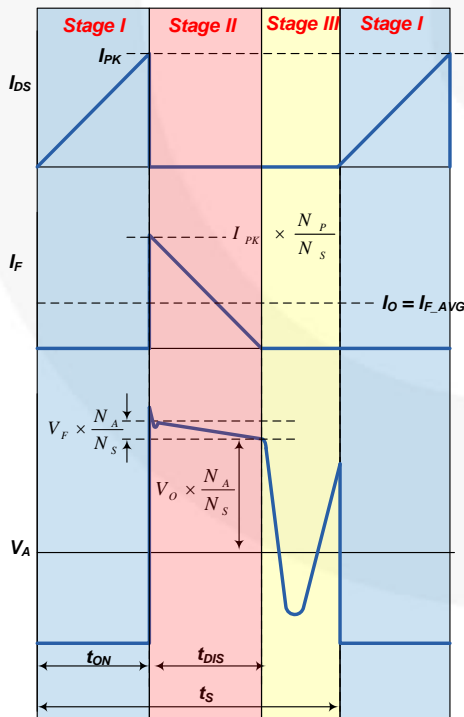

Figure 20. Waveforms of DCM Flyback Converter

V_{DD} Under-Voltage Lockout (UVLO)

The turn-on and turn-off thresholds are fixed internally at 16 V and 7.5 V, respectively. During startup, the V_{DD} capacitor (C_{VDD}) must be charged to 16 V. The V_{DD} capacitor (C_{VDD}) continues to supply V_{DD} until power can be delivered from the auxiliary winding of the main transformer. V_{DD} is not allowed to drop below 7.5 V during this startup process. This UVLO hysteresis window ensures that V_{DD} capacitor (C_{VDD}) properly supplies V_{DD} during startup.

V_{DD} Over-Voltage Protection (OVP)

The OVP prevents damage from over-voltage conditions. If the V_{DD} voltage exceeds 28 V at open-loop feedback condition, the OVP is triggered and the PWM switching is disabled. The OVP has a debounce time (typically 200 μs) to prevent false triggering due to switching noises.

Thermal Shutdown Protection (TSD)

The built-in temperature-sensing circuit shuts down PWM output if the junction temperature exceeds 140°C. There is a hysteresis of 15°C.

Pulse-by-Pulse Current Limit

When the current sensing voltage (V_{CS}) across the current-sense resistor (R_{Sense}) of MOSFET (Q1) exceeds the internal threshold of 0.8 V, the MOSFET (Q1) is turned off for the remainder of switching cycle. In normal operation, the pulse-by-pulse current limit is not triggered because the peak current is limited by the control loop.

Leading-Edge Blanking (LEB)

Each time the power MOSFET (Q1) switches on, a turn-on spike occurs at the sense resistor (R_{Sense}). To avoid premature termination of the switching pulse, a leading-edge blanking time is built in. Conventional RC filtering can be omitted. During this blanking period, the current-limit comparator is disabled and cannot switch off the gate driver.

Gate Output

The FL663 output stage is a fast totem-pole gate driver. Cross conduction has been avoided to minimize heat dissipation, increase efficiency, and enhance reliability. The output driver is clamped by an internal 15 V Zener diode to protect power MOSFET transistors against undesired over-voltage gate signals.

Built-in Slope Compensation

The sensed voltage across the current-sense resistor is used for Current Mode control and pulse-by-pulse current limiting. Built-in slope compensation improves stability and prevents sub-harmonic oscillations due to peak-current mode control. The FL663 has a synchronized, positive-slope ramp built-in at each switching cycle.

Noise Immunity

Noise from the current sense or the control signal can cause significant pulse-width jitter, particularly in Continuous-Conduction Mode. While slope compensation helps alleviate these problems, further precautions should still be taken. Good placement and layout practices should be followed. Avoiding long PCB traces and component leads, locating compensation and filter components near the FL663, and increasing the power MOSFET gate resistance are advised.

Operation Area

Figure 23 shows operation area. FL663 has two switching frequency (f_s) in Constant Current Mode. One is 50 kHz. In this case, FL663 can be operated with best condition for LED illumination. The output voltage range is between normal output voltage (V_{O^N}) and 50% of normal output voltage (V_{O^N}). The other is 33 kHz. When the output voltage is dropped by decreasing the number of LEDs, the output voltage (V_O) drops under 50% of normal voltage (V_{O^N}). At that time, V_{DD} drops to near UVLO protection and triggers protection. To avoid 33 kHz, V_{O^N} should be designed with enough margin.

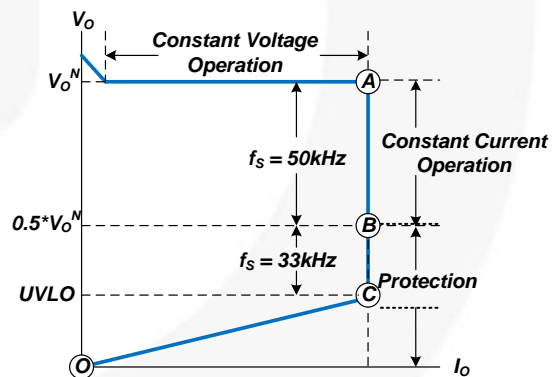
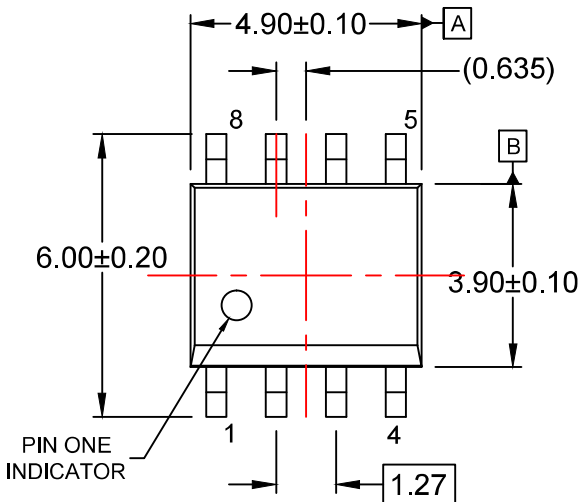
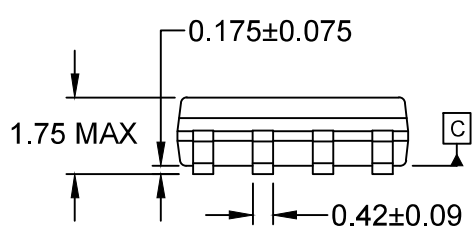
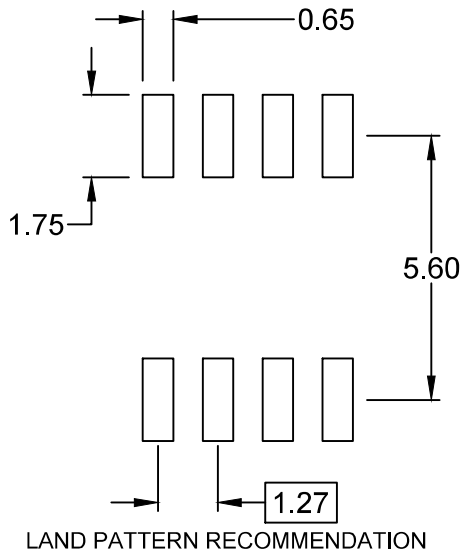

Figure 23. Operation Area



⊕ 0.25(M) C B A



0.10

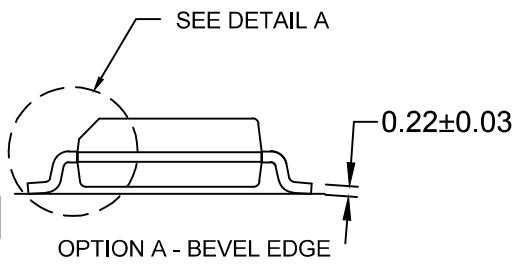

OPTION A - BEVEL EDGE

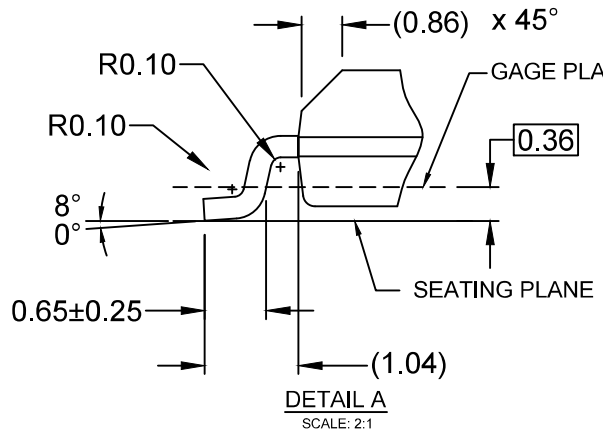

DETAIL A
SCALE: 2:1

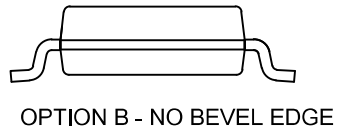

OPTION B - NO BEVEL EDGE

NOTES:

- A) THIS PACKAGE CONFORMS TO JEDEC MS-012, VARIATION AA.
- B) ALL DIMENSIONS ARE IN MILLIMETERS.
- C) DIMENSIONS DO NOT INCLUDE MOLD FLASH OR BURRS.
- D) LANDPATTERN STANDARD: SOIC127P600X175-8M
- E) DRAWING FILENAME: M08Arev16



ON Semiconductor and  are trademarks of Semiconductor Components Industries, LLC dba ON Semiconductor or its subsidiaries in the United States and/or other countries. ON Semiconductor owns the rights to a number of patents, trademarks, copyrights, trade secrets, and other intellectual property. A listing of ON Semiconductor's product/patent coverage may be accessed at www.onsemi.com/site/pdf/Patent-Marking.pdf. ON Semiconductor reserves the right to make changes without further notice to any products herein. ON Semiconductor makes no warranty, representation or guarantee regarding the suitability of its products for any particular purpose, nor does ON Semiconductor assume any liability arising out of the application or use of any product or circuit, and specifically disclaims any and all liability, including without limitation special, consequential or incidental damages. Buyer is responsible for its products and applications using ON Semiconductor products, including compliance with all laws, regulations and safety requirements or standards, regardless of any support or applications information provided by ON Semiconductor. "Typical" parameters which may be provided in ON Semiconductor data sheets and/or specifications can and do vary in different applications and actual performance may vary over time. All operating parameters, including "Typicals" must be validated for each customer application by customer's technical experts. ON Semiconductor does not convey any license under its patent rights nor the rights of others. ON Semiconductor products are not designed, intended, or authorized for use as a critical component in life support systems or any FDA Class 3 medical devices or medical devices with a same or similar classification in a foreign jurisdiction or any devices intended for implantation in the human body. Should Buyer purchase or use ON Semiconductor products for any such unintended or unauthorized application, Buyer shall indemnify and hold ON Semiconductor and its officers, employees, subsidiaries, affiliates, and distributors harmless against all claims, costs, damages, and expenses, and reasonable attorney fees arising out of, directly or indirectly, any claim of personal injury or death associated with such unintended or unauthorized use, even if such claim alleges that ON Semiconductor was negligent regarding the design or manufacture of the part. ON Semiconductor is an Equal Opportunity/Affirmative Action Employer. This literature is subject to all applicable copyright laws and is not for resale in any manner.

PUBLICATION ORDERING INFORMATION

LITERATURE FULFILLMENT:

Literature Distribution Center for ON Semiconductor
19521 E. 32nd Pkwy, Aurora, Colorado 80011 USA
Phone: 303-675-2175 or 800-344-3860 Toll Free USA/Canada
Fax: 303-675-2176 or 800-344-3867 Toll Free USA/Canada
Email: orderlit@onsemi.com

N. American Technical Support: 800-282-9855 Toll Free
USA/Canada
Europe, Middle East and Africa Technical Support:
Phone: 421 33 790 2910
Japan Customer Focus Center
Phone: 81-3-5817-1050

ON Semiconductor Website: www.onsemi.com
Order Literature: <http://www.onsemi.com/orderlit>
For additional information, please contact your local
Sales Representative

X-ON Electronics

Largest Supplier of Electrical and Electronic Components

Click to view similar products for [LED Lighting Drivers](#) category:

Click to view products by [ON Semiconductor](#) manufacturer:

Other Similar products are found below :

[LV5235V-MPB-H](#) [MB39C602PNF-G-JNEFE1](#) [MIC2871YMK-T5](#) [AL1676-10BS7-13](#) [AL1676-20AS7-13](#) [AP5726WUG-7](#) [ICL8201](#)
[IS31BL3228B-UTLS2-TR](#) [IS31BL3506B-TTLS2-TR](#) [AL3157F-7](#) [AP5725FDCG-7](#) [AP5726FDCG-7](#) [LV52204MTTBG](#) [AP5725WUG-7](#)
[STP4CMPQTR](#) [NCL30086BDR2G](#) [CAT4004BHU2-GT3](#) [LV52207AXA-VH](#) [AP1694AS-13](#) [TLE4242EJ](#) [AS3688](#) [IS31LT3172-GRLS4-TR](#)
[TLD2311EL](#) [KTD2694EDQ-TR](#) [KTZ8864EJAA-TR](#) [IS32LT3174-GRLA3-TR](#) [MP2488DN-LF-Z](#) [NLM0010XTSA1](#) [AL1676-20BS7-13](#)
[ZXLD1370QESTTC](#) [MPQ7220GF-AEC1-P](#) [MPQ7220GR-AEC1-P](#) [MPQ4425BGJ-AEC1-P](#) [MPQ7220GF-AEC1-Z](#) [MPQ7220GR-AEC1-Z](#)
[MPQ4425BGJ-AEC1-Z](#) [NCL30486A2DR2G](#) [IS31FL3737B-QFLS4-TR](#) [IS31FL3239-QFLS4-TR](#) [KTD2058EUAC-TR](#) [KTD2037EWE-TR](#)
[DIO5662ST6](#) [IS31BL3508A-TTLS2-TR](#) [KTD2026BEWE-TR](#) [MAX20052CATC/V+](#) [MAX25606AUP/V+](#) [BD6586MUV-E2](#) [BD9206EFV-E2](#) [BD9416FS-E2](#) [LYT4227E](#)