

# Half-Bridge Gate Driver

## FL73282

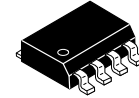

SOIC8  
CASE 751EB

### Description

The FL73282, a monolithic half bridge gate-drive IC, can drive MOSFETs and IGBTs that operate up to +900 V. onsemi's high-voltage process and common mode noise canceling technique provides stable operation of the high-side driver under high- $dV_S/dt$  noise circumstances. An advanced level-shift circuit allows high-side gate driver operation up to  $V_S = -9.8$  V (typical) for  $V_{BS} = 15$  V. The UVLO circuits for both channels prevent malfunction when  $V_{CC}$  or  $V_{BS}$  is lower than the specified threshold voltage. Output drivers typically source/sink 350 mA / 650 mA, respectively, which is suitable for all kinds of half- and full-bridge inverters.

### Features

- Floating Channel for Bootstrap Operation to +900 V
- Typically 350 mA / 650 mA Sourcing/Sinking Current Driving Capability for Both Channels
- Common-Mode  $dv/dt$  Noise Canceling Circuit
- Extended Allowable Negative  $V_S$  Swing to -9.8 V for Signal Propagation at  $V_{CC} = V_{BS} = 15$  V
- $V_{CC}$  &  $V_{BS}$  Supply Range from 10 V to 20 V
- UVLO Functions for Both Channels
- Matched Propagation Delay Below 50 ns
- Built-in 170 ns Dead-Time
- Output in Phase with Input Signal

### Applications

- Fluorescent Lamp Ballast
- HID Ballast
- SMPS
- Motor Driver
- General Purpose Half Bridge Topology

### MARKING DIAGRAM

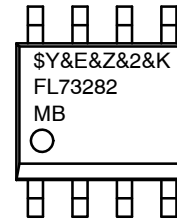

FL73282MB = Device Code  
\$Y = onsemi Logo  
&E = Designates Space  
&Z = Assembly Plant Code  
&2 = 2-Digit Date Code Format  
&K = 2-Digits Lot Run Traceability Code

### ORDERING INFORMATION

See detailed ordering and shipping information on page 13 of this data sheet.

APPLICATION DIAGRAM

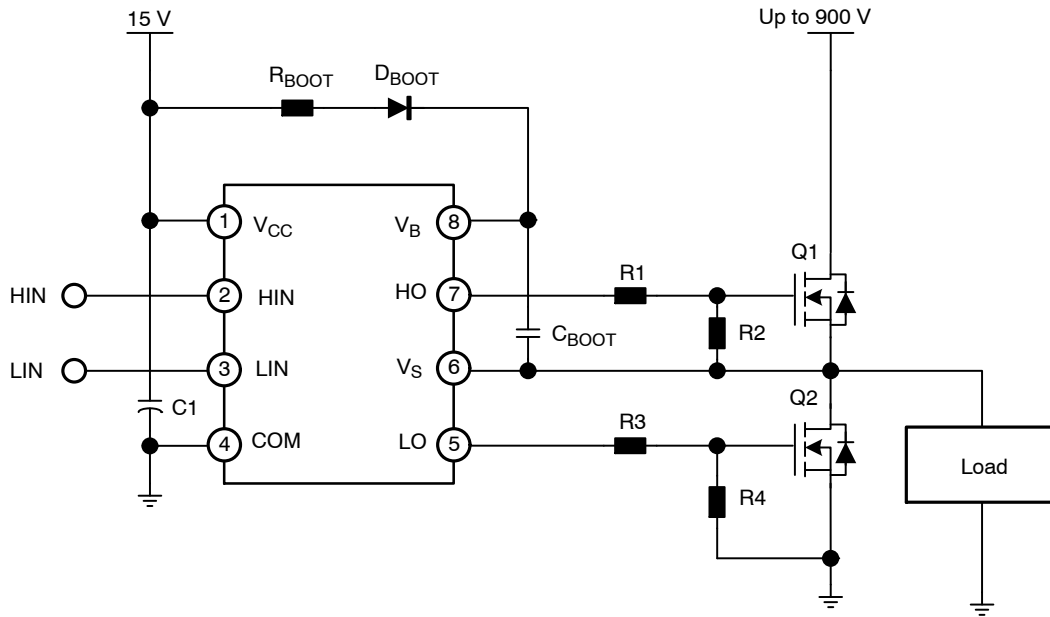

Figure 1. Application Circuit for Half Bridge Topology

BLOCK DIAGRAM

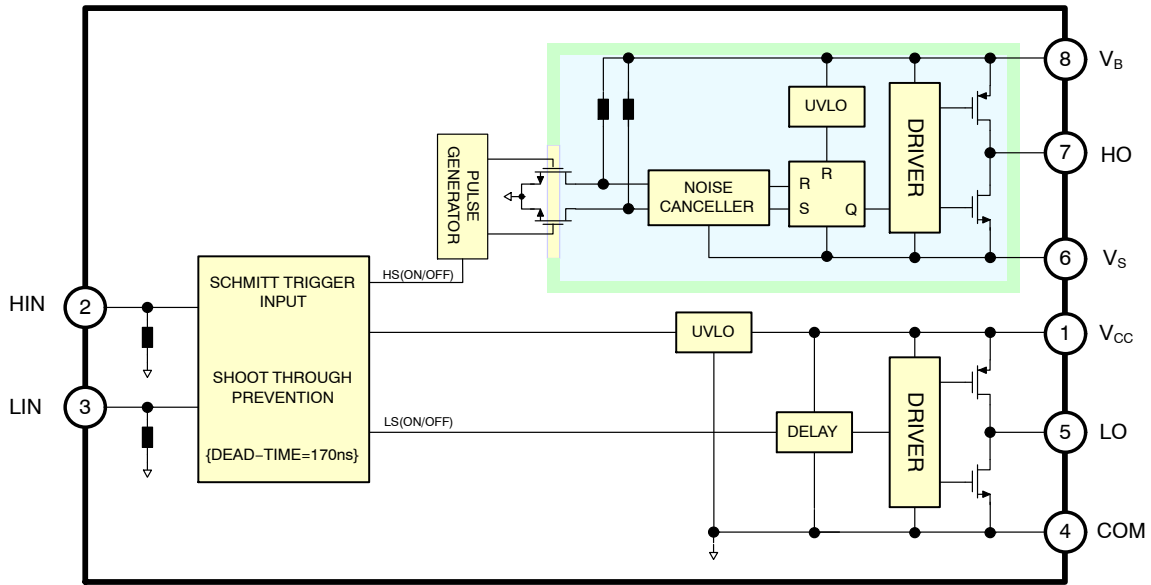

Figure 2. Functional Block Diagram

# FL73282

## PIN CONFIGURATION

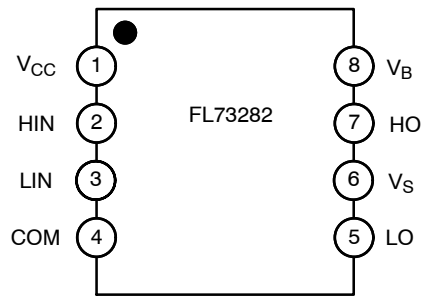

Figure 3. Pin Assignments (Top View)

### PIN DEFINITIONS

Pin No.	Name	I/O	Description
1	V <sub>CC</sub>	I	Low-Side Supply Voltage
2	HIN	I	Logic Input for High-Side Gate Driver Output
3	LIN	I	Logic Input for Low-Side Gate Driver Output
4	COM		Logic Ground and Low-Side Driver Return
5	LO	O	Low-Side Driver Output
6	V <sub>S</sub>	I	High-Voltage Floating Supply Return
7	HO	O	High-Side Driver Output
8	V <sub>B</sub>	I	High-Side Floating Supply

**ABSOLUTE MAXIMUM RATINGS**

Symbol	Parameter	Min	Max	Unit
V <sub>S</sub>	High-Side Floating Offset Voltage	V <sub>B</sub> -24	V <sub>B</sub> +0.3	V
V <sub>B</sub>	High-Side Floating Supply Voltage	-0.3	924.0	V
V <sub>CC</sub>	Low-Side and Logic-Fixed Supply Voltage	-0.3	24	V
V <sub>HO</sub>	High-Side Floating Output Voltage V <sub>HO</sub>	V <sub>S</sub> -0.3	V <sub>B</sub> +0.3	V
V <sub>LO</sub>	Low-Side Floating Output Voltage V <sub>LO</sub>	-0.3	V <sub>CC</sub> +0.3	V
V <sub>IN</sub>	Logic Input Voltage (HIN, LIN)	-0.3	V <sub>CC</sub> +0.3	V
COM	Logic Ground	V <sub>CC</sub> -24	V <sub>CC</sub> +0.3	V
dV <sub>S</sub> /dt	Allowable Offset Voltage Slew Rate	-	±50	V/ns
P <sub>D</sub>	Power Dissipation (Notes 2, 3, 4)	-	0.625	W
θ <sub>JA</sub>	Thermal Resistance	-	200	°C/W
T <sub>J</sub>	Junction Temperature	-	150	°C
T <sub>STG</sub>	Storage Temperature	-55	150	°C

Stresses exceeding those listed in the Maximum Ratings table may damage the device. If any of these limits are exceeded, device functionality should not be assumed, damage may occur and reliability may be affected.

1. Mounted on 76.2 x 114.3 x 1.6 mm PCB (FR-4 glass epoxy material).
2. Refer to the following standards:  
*JESD51-2: Integral circuit's thermal test method environmental conditions, natural convection;*  
*JESD51-3: Low effective thermal conductivity test board for leaded surface-mount packages.*
3. Do not exceed maximum power dissipation (P<sub>D</sub>) under any circumstances.

**RECOMMENDED OPERATING CONDITIONS**

Symbol	Parameter	Min	Max	Unit
V <sub>B</sub>	High-Side Floating Supply Voltage	V <sub>S</sub> +10	V <sub>S</sub> +20	V
V <sub>S</sub>	High-Side Floating Supply Offset Voltage	6-V <sub>CC</sub>	900	V
V <sub>HO</sub>	High-Side (HO) Output Voltage	V <sub>S</sub>	V <sub>B</sub>	V
V <sub>LO</sub>	Low-Side (LO) Output Voltage	COM	V <sub>CC</sub>	V
V <sub>IN</sub>	Logic Input Voltage (HIN, LIN)	COM	V <sub>CC</sub>	V
V <sub>CC</sub>	Low-Side Supply Voltage	10	20	V
T <sub>A</sub>	Ambient Temperature	-40	+125	°C

Functional operation above the stresses listed in the Recommended Operating Ranges is not implied. Extended exposure to stresses beyond the Recommended Operating Ranges limits may affect device reliability.

**STATIC ELECTRICAL CHARACTERISTICS**

$V_{BIAS}(V_{CC}, V_{BS}) = 15.0\text{ V}$ ,  $T_A = 25^\circ\text{C}$ , unless otherwise specified. The  $V_{IN}$  and  $I_{IN}$  parameters are referenced to COM. The  $V_O$  and  $I_O$  parameters are referenced to  $V_S$  and COM and are applicable to the respective outputs HO and LO.

Symbol	Parameter	Conditions	Min	Typ	Max	Unit
<b>POWER SUPPLY SECTION</b>						
$I_{QCC}$	Quiescent $V_{CC}$ Supply Current	$V_{IN} = 0\text{ V or } 5\text{ V}$	–	80	180	$\mu\text{A}$
$I_{QBS}$	Quiescent $V_{BS}$ Supply Current	$V_{IN} = 0\text{ V or } 5\text{ V}$	–	50	120	$\mu\text{A}$
$I_{PCC}$	Operating $V_{CC}$ Supply Current	$f_{IN} = 20\text{ kHz, rms value}$	–	–	550	$\mu\text{A}$
$I_{PBS}$	Operating $V_{BS}$ Supply Current	$f_{IN} = 20\text{ kHz, rms value}$	–	–	600	$\mu\text{A}$
$I_{LK}$	Offset Supply Leakage Current	$V_B = V_S = 900\text{ V}$	–	–	10	$\mu\text{A}$

**BOOTSTRAPPED SUPPLY SECTION**

$V_{CCUV+}$ $V_{BSUV+}$	$V_{CC}$ & $V_{BS}$ Supply Under-Voltage Positive going Threshold		8.2	9.2	10.0	V
$V_{CCUV-}$ $V_{BSUV-}$	$V_{CC}$ & $V_{BS}$ Supply Under-Voltage Negative going Threshold		7.6	8.7	9.6	V
$V_{CCUVH}$ $V_{BSUVH}$	$V_{CC}$ Supply Under-Voltage Lockout Hysteresis		–	0.5	–	V

**INPUT SECTION**

$V_{IH}$	Logic “1” Input Voltage		2.5	–	–	V
$V_{IL}$	Logic “0” Input Voltage		–	–	0.8	V
$I_{IN+}$	Logic “1” Input Bias Current	$V_{IN} = 5\text{ V}$	–	20	50	$\mu\text{A}$
$I_{IN-}$	Logic “0” Input Bias Current	$V_{IN} = 0\text{ V}$	–	1.0	2.0	$\mu\text{A}$
$R_{IN}$	Logic Input Pull-Down Resistance		100	250	–	$\text{k}\Omega$

**GATE DRIVER OUTPUT SECTION**

$V_{OH}$	High-Level Output Voltage, $V_{BIAS-VO}$	$I_O = 0\text{ A}$	–	–	85	mV
$V_{OL}$	Low-Level Output Voltage, $V_O$	$I_O = 0\text{ A}$	–	–	85	mV
$I_{O+}$	Output HIGH Short-Circuit Pulsed Current	$V_O = 0\text{ V}$ , $V_{IN} = 5\text{ V with } PW \leq 10\ \mu\text{s}$	250	350	–	mA
$I_{O-}$	Output LOW Short-Circuit Pulsed Current	$V_O = 15\text{ V}$ , $V_{IN} = 0\text{ V with } PW \leq 10\ \mu\text{s}$	500	650	–	mA
$V_S$	Allowable Negative $V_S$ Pin Voltage for HIN Signal Propagation to HO		–	–9.8	–7.0	V

**DYNAMIC ELECTRICAL CHARACTERISTICS**

$V_{BIAS}(V_{CC}, V_{BS}) = 15.0\text{ V}$ ,  $V_S = \text{COM}$ ,  $C_L = 1000\text{ pF}$  and  $T_A = 25^\circ\text{C}$ , unless otherwise specified.

Symbol	Parameter	Conditions	Min	Typ	Max	Unit
$t_{ON}$	Turn-On Propagation Delay	$V_S = 0\text{ V}$	80	150	220	ns
$t_{OFF}$	Turn-Off Propagation Delay	$V_S = 0\text{ V or } 900\text{ V (Note 4)}$	80	150	220	ns
$t_R$	Turn-On Rise Time	$V_{LIN} = V_{HIN} = 5\text{ V}$	–	60	140	ns
$t_F$	Turn-Off Fall Time	$V_{LIN} = V_{HIN} = 0\text{ V}$	–	30	80	ns
DT	Dead Time		70	170	270	ns
MT	Delay Matching, HS & LS Turn-on/off		–	–	50	ns
$t_{PW}$	Minimum Input Pulse Width that Changes the Output (Notes 4, 5)		–	–	220	ns

4. These parameters are guaranteed by design.
5. The minimum input pulse width time included dead time.

TYPICAL CHARACTERISTICS

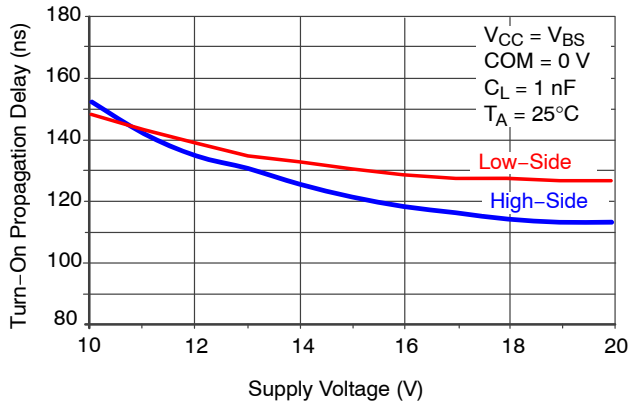

Figure 4. Turn-On Propagation Delay vs. Supply Voltage

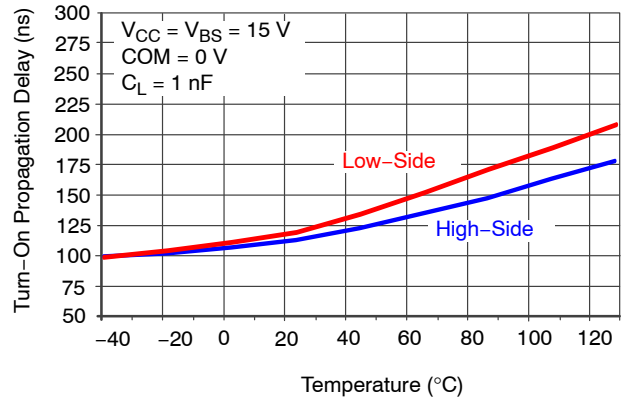

Figure 5. Turn-On Propagation Delay vs. Temperature

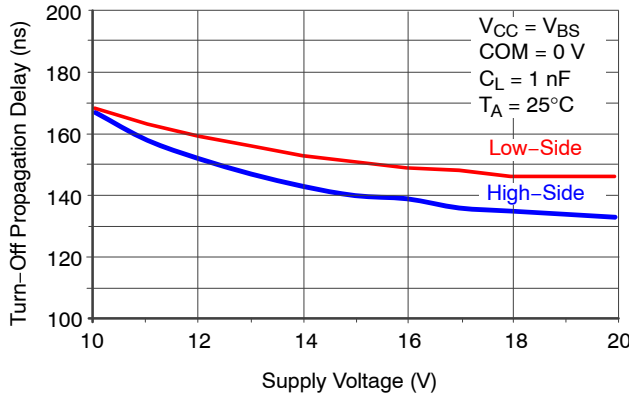

Figure 6. Turn-Off Propagation Delay vs. Supply Voltage

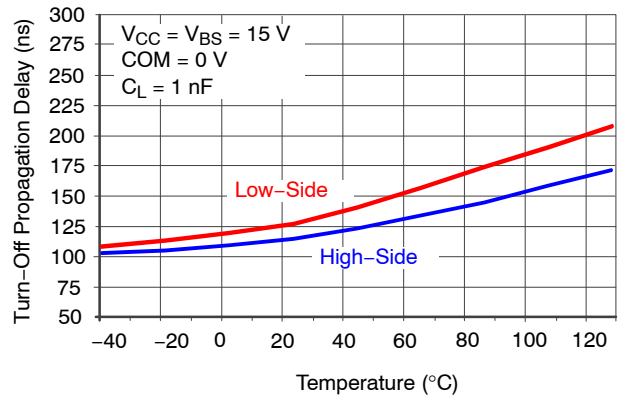

Figure 7. Turn-Off Propagation Delay vs. Temperature

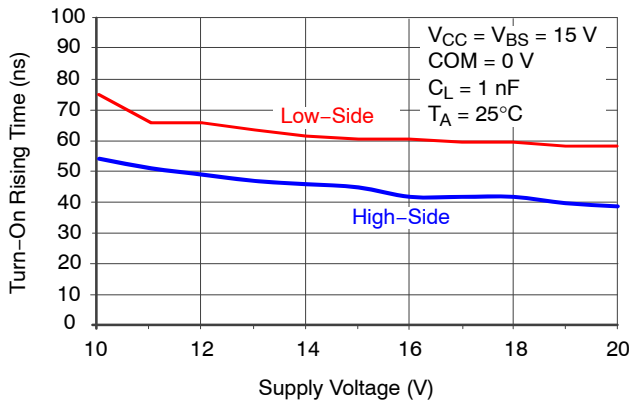

Figure 8. Turn-On Rising Time vs. Supply Voltage

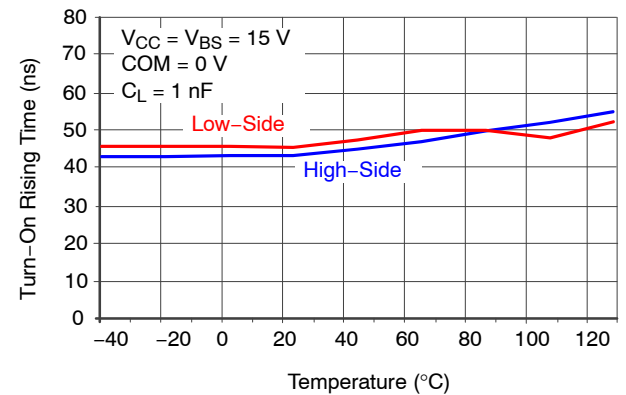

Figure 9. Turn-On Rising Time vs. Temperature

TYPICAL CHARACTERISTICS (continued)

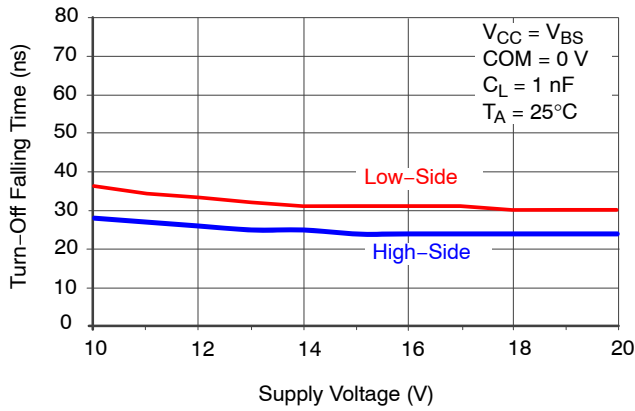

Figure 10. Turn-Off Falling Time vs. Supply Voltage

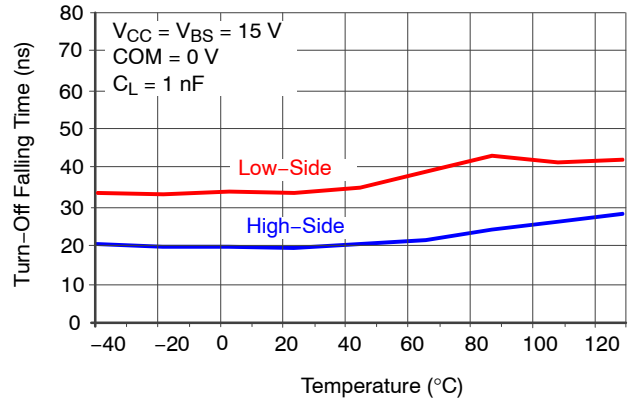

Figure 11. Turn-Off Falling Time vs. Temperature

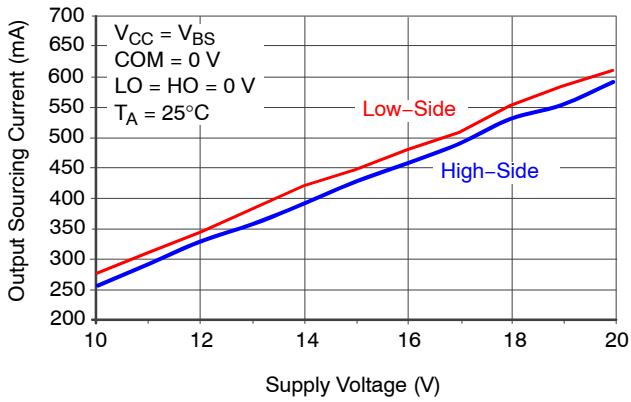

Figure 12. Output Sourcing Current vs. Supply Voltage

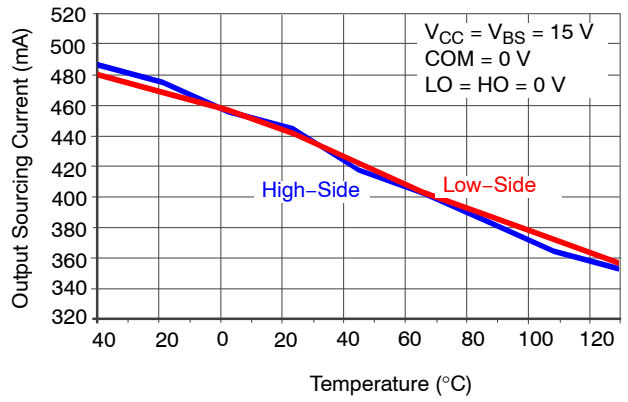

Figure 13. Output Sourcing Current vs. Temperature

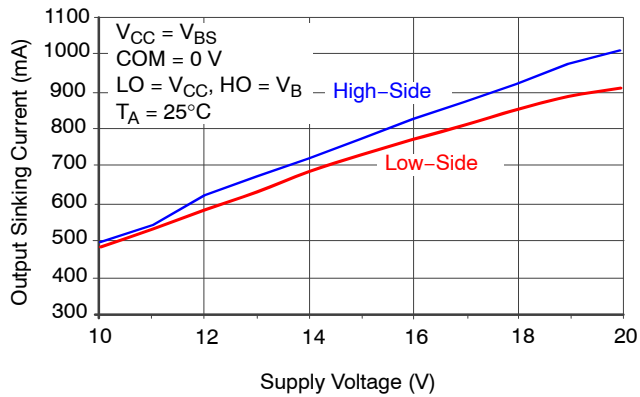

Figure 14. Output Sinking Current vs. Supply Voltage

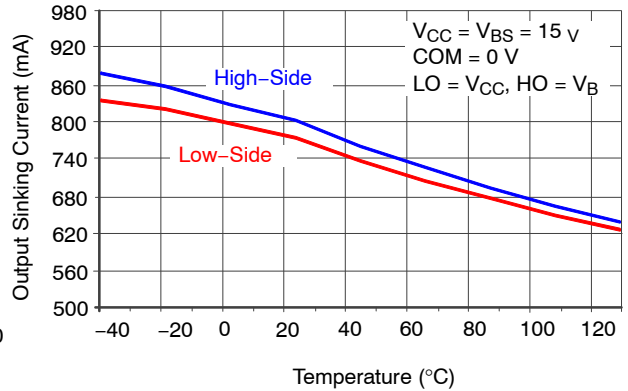

Figure 15. Output Sinking Current vs. Temperature

TYPICAL CHARACTERISTICS (continued)

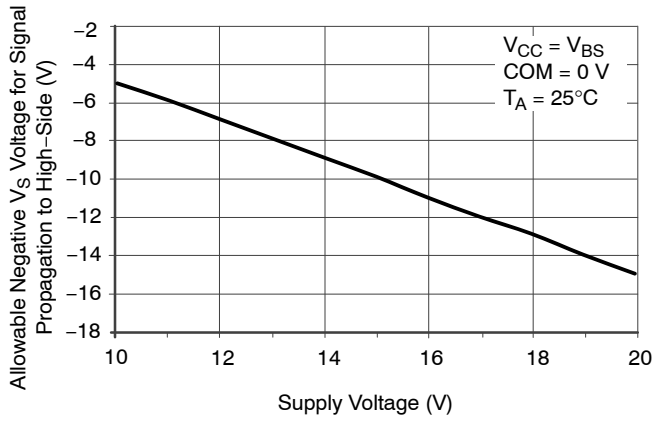

Figure 16. Allowable Negative  $V_S$  Voltage for Signal Propagation to High Side vs. Supply Voltage

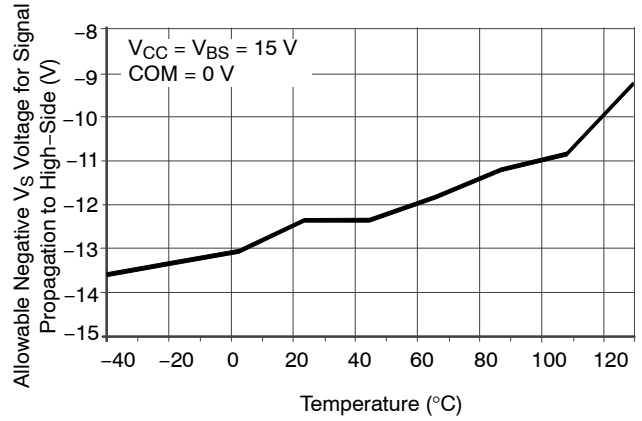

Figure 17. Allowable Negative  $V_S$  Voltage for Signal Propagation to High Side vs. Temperature

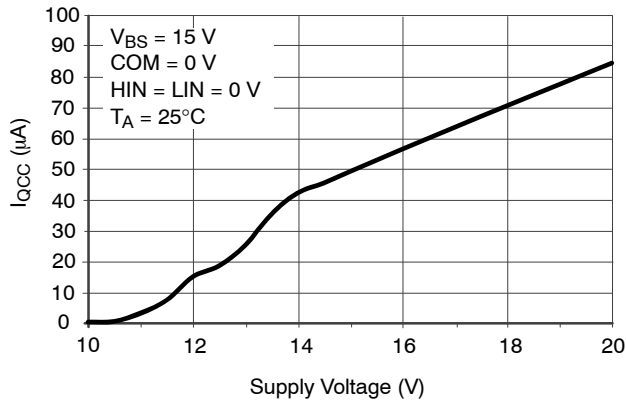

Figure 18.  $I_{QCC}$  vs. Supply Voltage

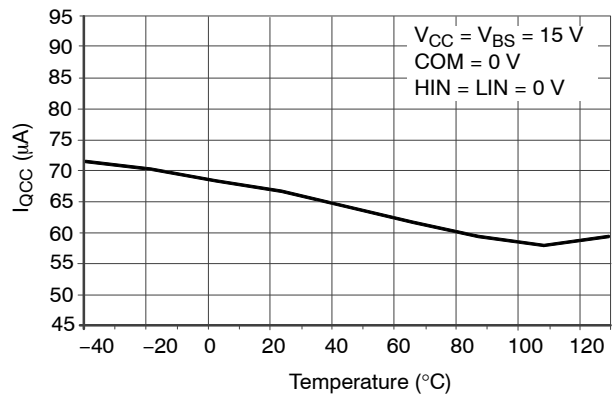

Figure 19.  $I_{QCC}$  vs. Temperature

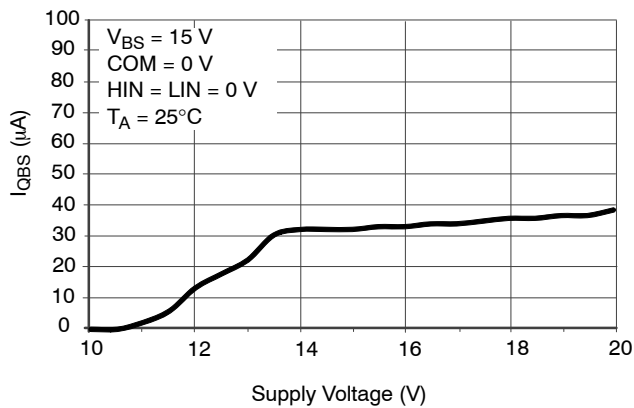

Figure 20.  $I_{QBS}$  vs. Supply Voltage

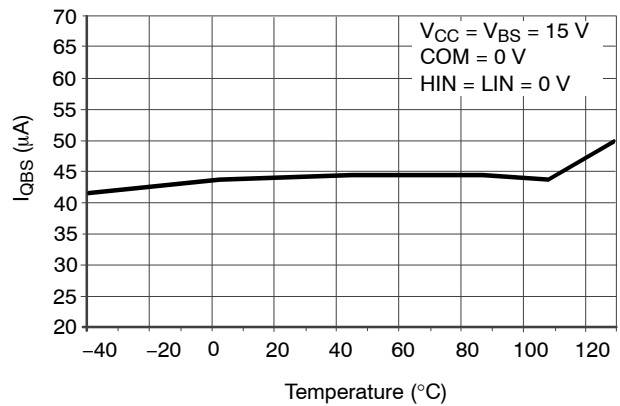

Figure 21.  $I_{QBS}$  vs. Temperature



TYPICAL CHARACTERISTICS (continued)

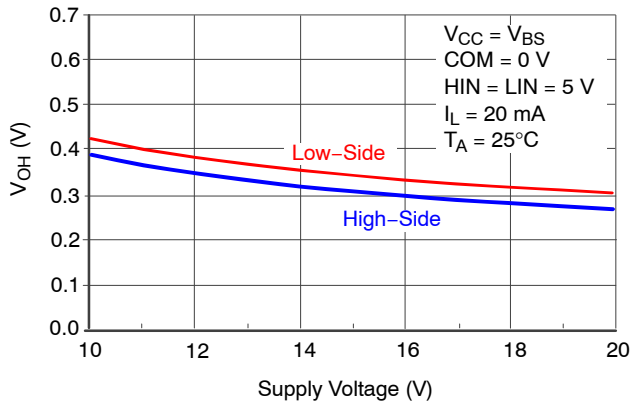

Figure 22. High-Level Output Voltage vs. Supply Voltage

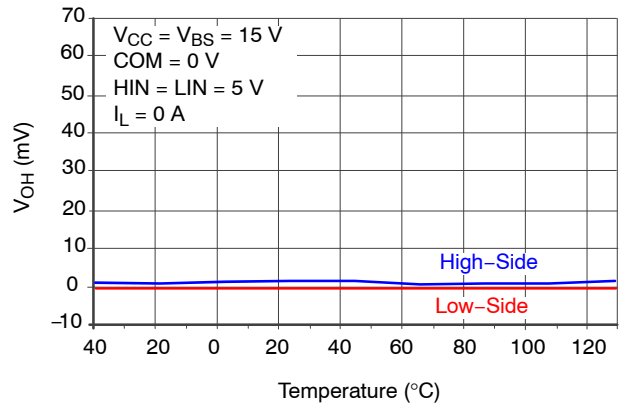

Figure 23. High-Level Output Voltage vs. Temperature

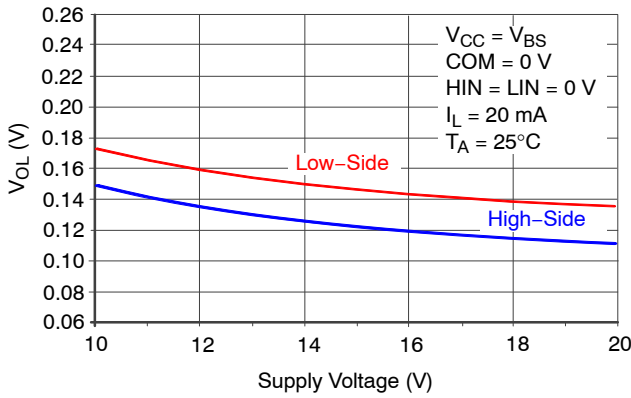

Figure 24. Low-Level Output Voltage vs. Supply Voltage

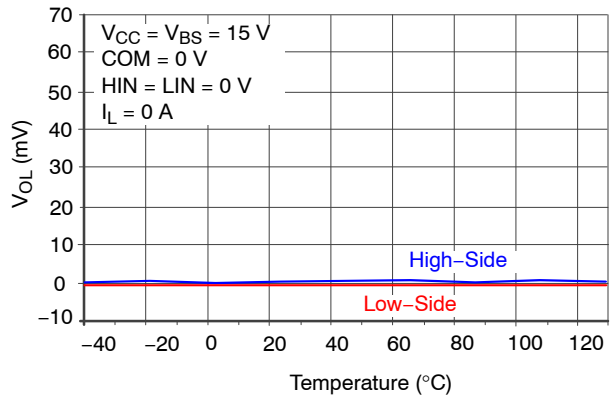

Figure 25. Low-Level Output Voltage vs. Temperature

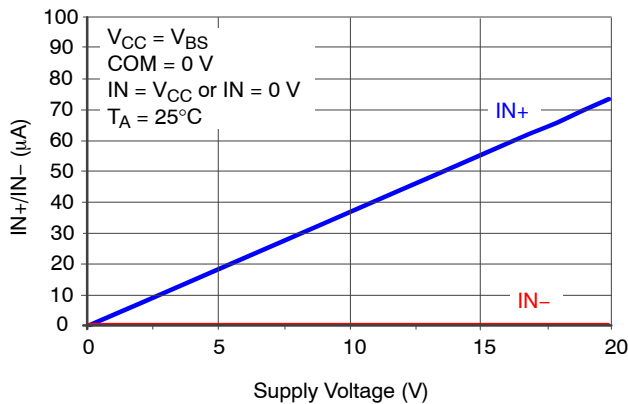

Figure 26. Input Bias Current vs. Supply Voltage

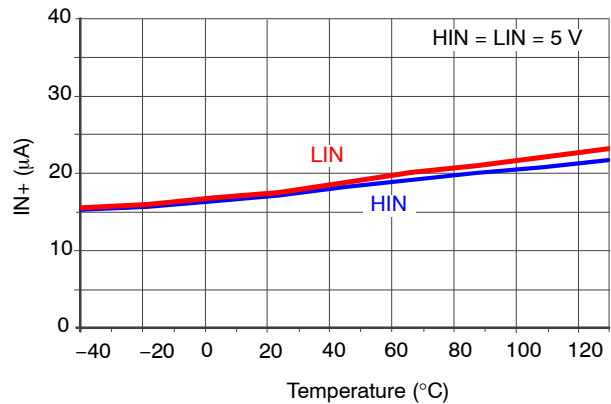

Figure 27. Input Bias Current vs. Temperature

TYPICAL CHARACTERISTICS (continued)

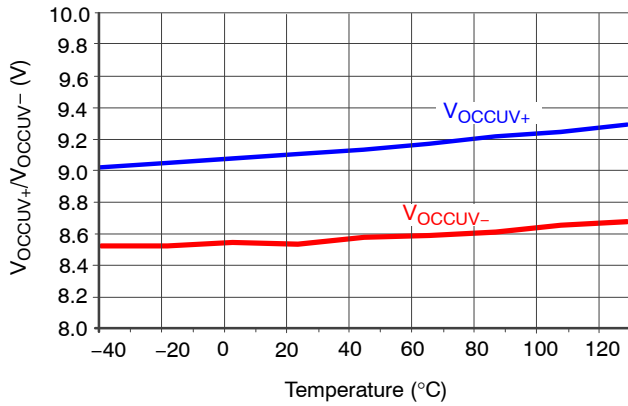

Figure 28. V<sub>CC</sub> UVLO Threshold Voltage vs. Temperature

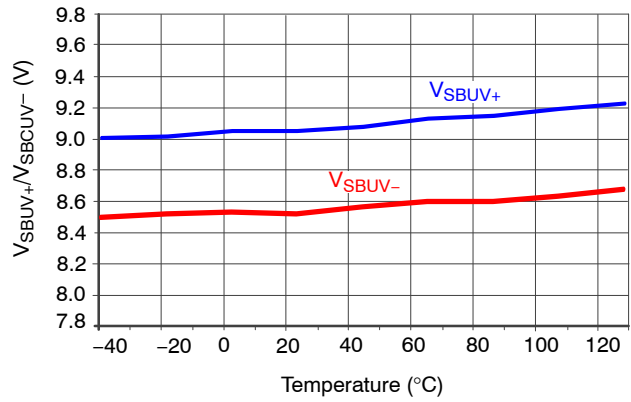

Figure 29. V<sub>BS</sub> UVLO Threshold Voltage vs. Temperature

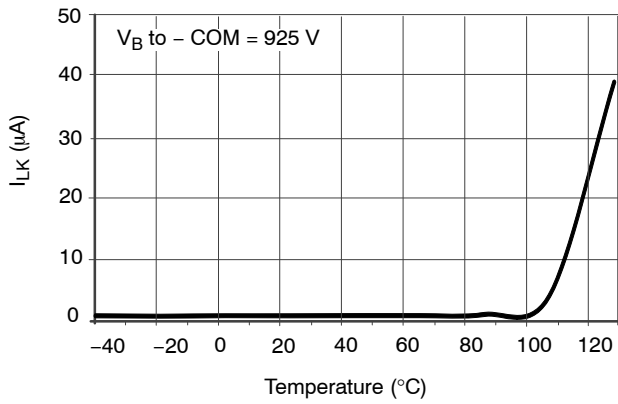

Figure 30. V<sub>B</sub> to COM Leakage Current vs. Temperature

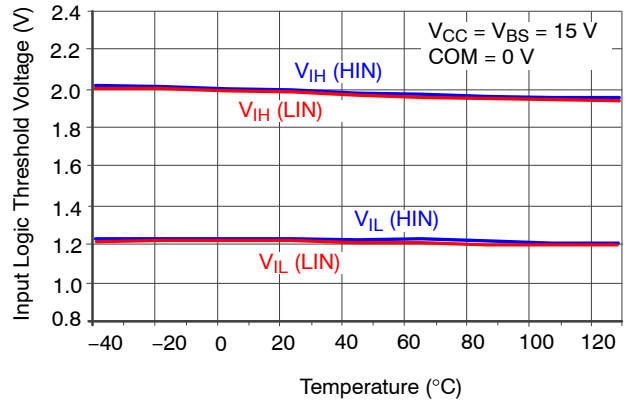

Figure 31. Input Logic Threshold Voltage vs. Temperature

SWITCHING TIME DEFINITIONS

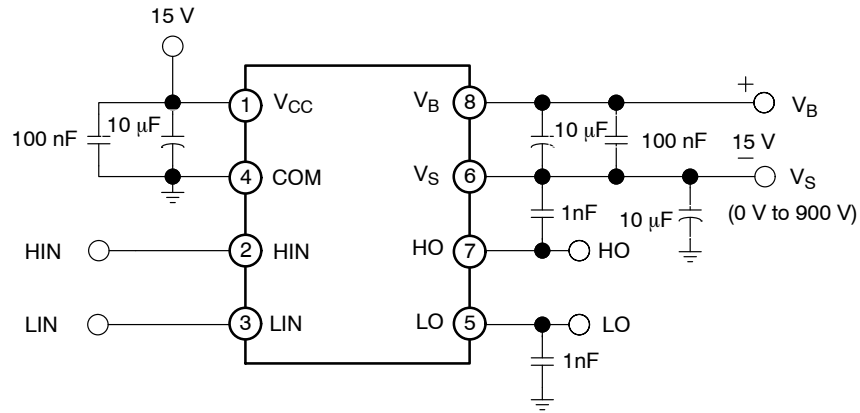

Figure 32. Switching Time Test Circuit

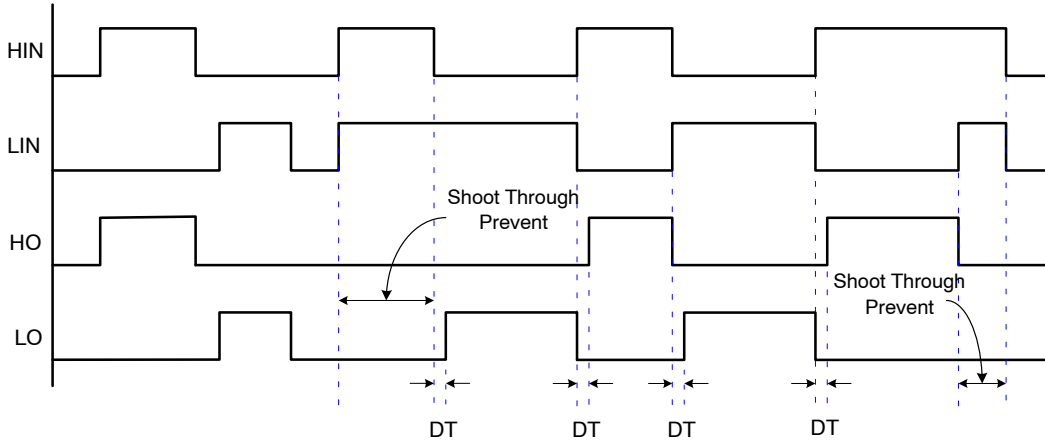

Figure 33. Input / Output Timing Diagram

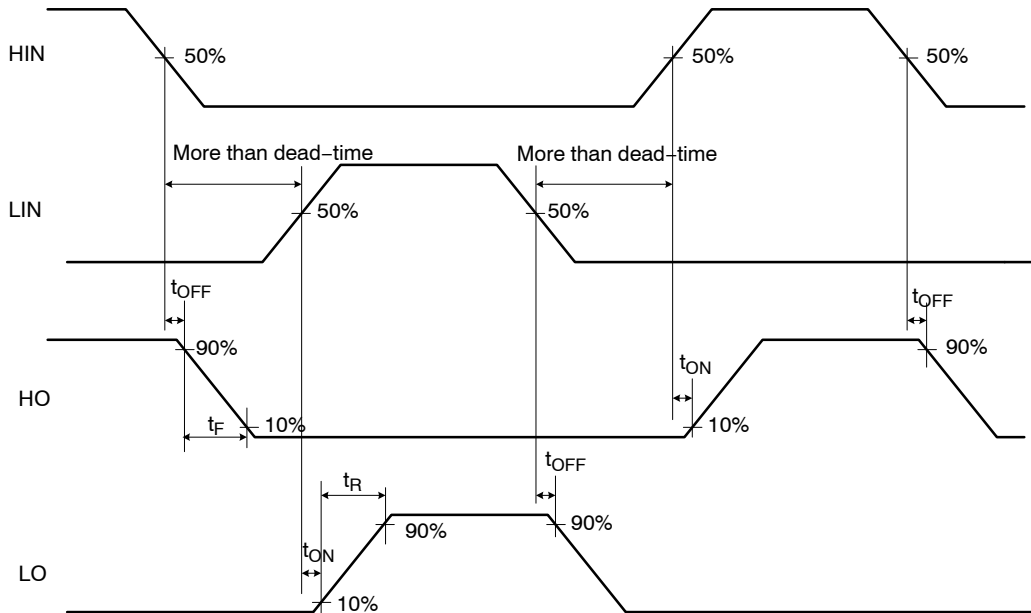

Figure 34. Switching Time Definition

SWITCHING TIME DEFINITIONS (continued)

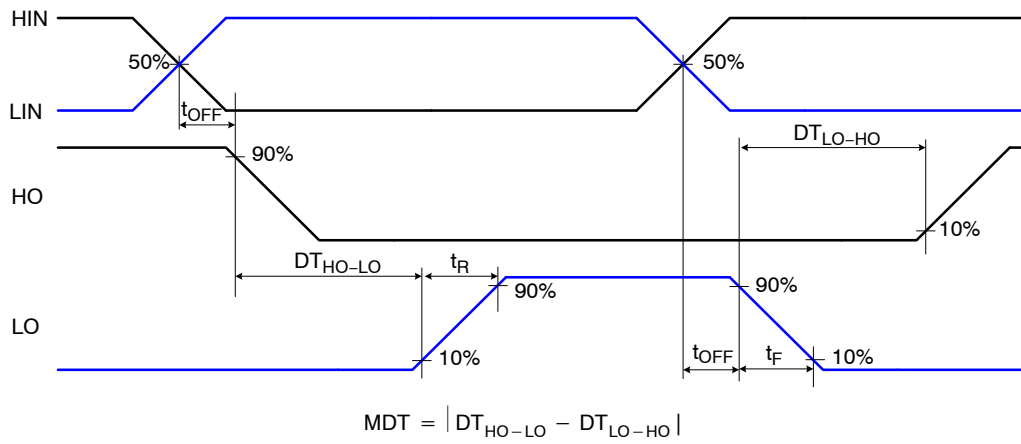

Figure 35. Internal Dead Time Definition

# FL73282

## ORDERING INFORMATION

Part Number	Operating Temperature Range	Package	Shipping <sup>†</sup>
FL73282MX (Note 6)	-40°C to +125°C	8-Lead, Small Outline Integrated Circuit, (SOIC), (Pb-Free)	2500 / Tape & Reel

6. These devices passed wave-soldering test by JESD22A-111.

**MECHANICAL CASE OUTLINE**  
**PACKAGE DIMENSIONS**

ON Semiconductor®



**SOIC8**  
**CASE 751EB**  
**ISSUE A**

DATE 24 AUG 2017



⊕ 0.25 (M) C B A



⌒ 0.10

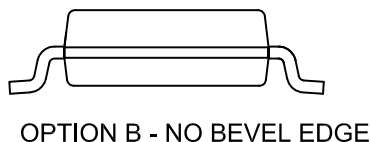
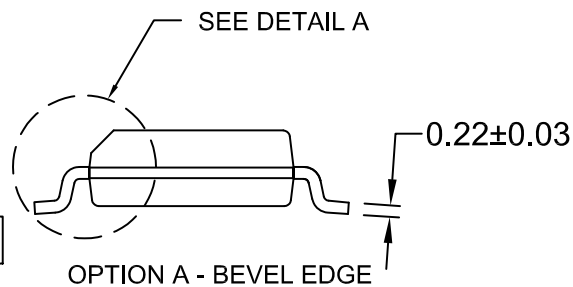

**NOTES:**

- A) THIS PACKAGE CONFORMS TO JEDEC MS-012, VARIATION AA.
- B) ALL DIMENSIONS ARE IN MILLIMETERS.
- C) DIMENSIONS DO NOT INCLUDE MOLD FLASH OR BURRS.
- D) LANDPATTERN STANDARD: SOIC127P600X175-8M

<b>DOCUMENT NUMBER:</b>	<b>98AON13735G</b>	Electronic versions are uncontrolled except when accessed directly from the Document Repository. Printed versions are uncontrolled except when stamped "CONTROLLED COPY" in red.
<b>DESCRIPTION:</b>	<b>SOIC8</b>	<b>PAGE 1 OF 1</b>

ON Semiconductor and are trademarks of Semiconductor Components Industries, LLC dba ON Semiconductor or its subsidiaries in the United States and/or other countries. ON Semiconductor reserves the right to make changes without further notice to any products herein. ON Semiconductor makes no warranty, representation or guarantee regarding the suitability of its products for any particular purpose, nor does ON Semiconductor assume any liability arising out of the application or use of any product or circuit, and specifically disclaims any and all liability, including without limitation special, consequential or incidental damages. ON Semiconductor does not convey any license under its patent rights nor the rights of others.

**onsemi**, **Onsemi**, and other names, marks, and brands are registered and/or common law trademarks of Semiconductor Components Industries, LLC dba "**onsemi**" or its affiliates and/or subsidiaries in the United States and/or other countries. **onsemi** owns the rights to a number of patents, trademarks, copyrights, trade secrets, and other intellectual property. A listing of **onsemi**'s product/patent coverage may be accessed at [www.onsemi.com/site/pdf/Patent-Marking.pdf](http://www.onsemi.com/site/pdf/Patent-Marking.pdf). **onsemi** reserves the right to make changes at any time to any products or information herein, without notice. The information herein is provided "as-is" and **onsemi** makes no warranty, representation or guarantee regarding the accuracy of the information, product features, availability, functionality, or suitability of its products for any particular purpose, nor does **onsemi** assume any liability arising out of the application or use of any product or circuit, and specifically disclaims any and all liability, including without limitation special, consequential or incidental damages. Buyer is responsible for its products and applications using **onsemi** products, including compliance with all laws, regulations and safety requirements or standards, regardless of any support or applications information provided by **onsemi**. "Typical" parameters which may be provided in **onsemi** data sheets and/or specifications can and do vary in different applications and actual performance may vary over time. All operating parameters, including "Typicals" must be validated for each customer application by customer's technical experts. **onsemi** does not convey any license under any of its intellectual property rights nor the rights of others. **onsemi** products are not designed, intended, or authorized for use as a critical component in life support systems or any FDA Class 3 medical devices or medical devices with a same or similar classification in a foreign jurisdiction or any devices intended for implantation in the human body. Should Buyer purchase or use **onsemi** products for any such unintended or unauthorized application, Buyer shall indemnify and hold **onsemi** and its officers, employees, subsidiaries, affiliates, and distributors harmless against all claims, costs, damages, and expenses, and reasonable attorney fees arising out of, directly or indirectly, any claim of personal injury or death associated with such unintended or unauthorized use, even if such claim alleges that **onsemi** was negligent regarding the design or manufacture of the part. **onsemi** is an Equal Opportunity/Affirmative Action Employer. This literature is subject to all applicable copyright laws and is not for resale in any manner.

## PUBLICATION ORDERING INFORMATION

### LITERATURE FULFILLMENT:

Email Requests to: [orderlit@onsemi.com](mailto:orderlit@onsemi.com)

**onsemi Website:** [www.onsemi.com](http://www.onsemi.com)

### TECHNICAL SUPPORT

**North American Technical Support:**

Voice Mail: 1 800-282-9855 Toll Free USA/Canada

Phone: 011 421 33 790 2910

**Europe, Middle East and Africa Technical Support:**

Phone: 00421 33 790 2910

For additional information, please contact your local Sales Representative

## X-ON Electronics

Largest Supplier of Electrical and Electronic Components

*Click to view similar products for [Gate Drivers](#) category:*

*Click to view products by [ON Semiconductor](#) manufacturer:*

Other Similar products are found below :

[89076GBEST](#) [00053P0231](#) [56956](#) [57.404.7355.5](#) [LT4936](#) [57.904.0755.0](#) [5882900001](#) [00600P0005](#) [00-9050-LRPP](#) [00-9090-RDPP](#)  
[5951900000](#) [01-1003W-10/32-15](#) [0131700000](#) [00-2240](#) [LTP70N06](#) [LVP640](#) [5J0-1000LG-SIL](#) [LY1D-2-5S-AC120](#) [LY2-US-AC240](#) [LY3-](#)  
[UA-DC24](#) [00576P0020](#) [00600P0010](#) [LZN4-UA-DC12](#) [LZNQ2M-US-DC5](#) [LZNQ2-US-DC12](#) [LZP40N10](#) [00-8196-RDPP](#) [00-8274-RDPP](#)  
[00-8275-RDNP](#) [00-8722-RDPP](#) [00-8728-WHPP](#) [00-8869-RDPP](#) [00-9051-RDPP](#) [00-9091-LRPP](#) [00-9291-RDPP](#) [0207100000](#) [0207400000](#)  
[01312](#) [0134220000](#) [60713816](#) [M15730061](#) [61161-90](#) [61278-0020](#) [6131-204-23149P](#) [6131-205-17149P](#) [6131-209-15149P](#) [6131-218-17149P](#)  
[6131-220-21149P](#) [6131-260-2358P](#) [6131-265-11149P](#)