

Single Channel, DC Sensing Input, Phototransistor Optocoupler In Stretched Body SOP 4-Pin

FODM100x Series

Description

The FODM100x Series, single channel, DC sensing input, optocoupler consists of one gallium arsenide (GaAs) infrared light emitting diode optically coupled to one phototransistor, in a stretched body SOP 4-pin package. The input-output isolation voltage, V_{ISO} , is rated at 5,000 VAC_{RMS}.

Features

- ≥ 8 mm Creepage and Clearance Distance, and ≥ 0.4 mm Insulation Distance to Achieve Reliable and High Voltage Insulation
- Safety and Regulatory Approvals
- UL1577, 5,000 VAC_{RMS} for 1 min
- DIN_EN/IEC60747-5-5, 890 V_{Peak} Working Voltage
- High Breakdown Collector to Emitter Voltage, $BV_{CEO} = 70$ V Minimum
- Extended Industrial Temperature Range, -40 to 110°C
- Current Transfer Ratio at $I_F = 5$ mA, $V_{CE} = 5$ V, $T_A = 25^{\circ}\text{C}$
- FODM1007: 80 to 160%
- FODM1008: 130 to 260%
- FODM1009: 200 to 400%
- These are Pb-Free Devices

Applications

- Primarily Suited for DC-DC Converters
- For Ground Loop Isolation, Signal to Noise Isolation
- Communications – Adapters, Chargers
- Consumer – Appliances, Set-Top Boxes
- Industrial – Power Supplies, Motor Control, Programmable Logic Control

Related Resources

- <https://www.onsemi.com/products/optoelectronics/>
- www.onsemi.com/datsheets/HM/HMHA2801.pdf



ON Semiconductor®

www.onsemi.com



SSOP4 / LSOP04
CASE 565BH

MARKING DIAGRAM

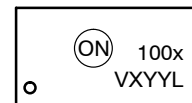

- 100x = Specific Device Code (x = 7, 8, 9)
- V = DIN EN/IEC60747-5-5 Option (only appears on component ordered with this option)
- X = Last Digit Year Code
- YY = Two Digit Work Week
- L = Assembly Package Code

PIN CONNECTIONS

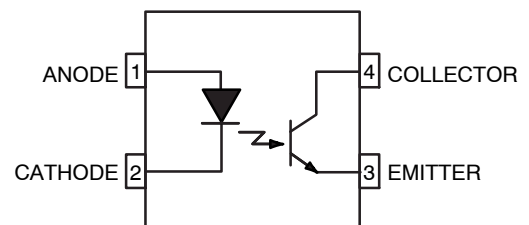

ORDERING INFORMATION

See detailed ordering and shipping information on page 7 of this data sheet.

FODM100x Series

SAFETY AND INSULATION RATINGS (As per DIN EN/IEC 60747-5-5, this optocoupler is suitable for “safe electrical insulation” only within the safety limit data. Compliance with the safety ratings shall be ensured by means of protective circuits.)

Parameter	Characteristics
Installation Classifications per DIN VDE 0110/1.89 Table 1, For Rated Mains Voltage	<150 V _{RMS}
	<300 V _{RMS}
Climatic Classification	40/110/21
Pollution Degree (DIN VDE 0110/1.89)	2
Comparative Tracking Index	175

Symbol	Parameter	Value	Unit
V _{PR}	Input-to-Output Test Voltage, Method A, V _{IORM} × 1.6 = V _{PR} , Type and Sample Test with t _m = 10 s, Partial Discharge < 5 pC	1,426	V _{peak}
	Input-to-Output Test Voltage, Method B, V _{IORM} × 1.875 = V _{PR} , 100% Production Test with t _m = 1 s, Partial Discharge < 5 pC	1,671	V _{peak}
V _{IORM}	Maximum Working Insulation Voltage	890	V _{peak}
V _{IOTM}	Highest Allowable Over-Voltage	6,000	V _{peak}
	External Creepage	≥8.0	mm
	External Clearance	≥8.0	mm
DTI	Distance Through Insulation (Insulation Thickness)	≥0.4	mm
T _S	Case Temperature (Note 1)	150	°C
I _{S,INPUT}	Input Current (Note 1)	200	mA
P _{S,OUTPUT}	Output Power (Note 1)	300	mW
R _{IO}	Insulation Resistance at T _S , V _{IO} = 500 V (Note 1)	>10 ⁹	Ω

1. Safety limit values – maximum values allowed in the event of a failure.

ABSOLUTE MAXIMUM RATINGS (T_A = 25°C, unless otherwise noted)

Symbol	Parameter	Value	Unit
--------	-----------	-------	------

TOTAL PACKAGE

T _{STG}	Storage Temperature	-55 to +150	°C
T _{OPR}	Operating Temperature	-40 to +110	°C
T _J	Junction Temperature	-40 to +125	°C

EMITTER

I _{F(avg)}	Continuous Forward Current	50	mA
I _{F(pk)}	Continuous Forward Current (1 μs Pulse, 300 pps)	1	A
V _R	Reverse Input Voltage	6	V
PD _{LED}	LED Power Dissipation @ T _A = 25°C (Note 2)	100	mW
	Derate Above 25°C	0.9	mW/°C

DETECTOR

I _C	Continuous Collector Current	50	mA
V _{CEO}	Collector-Emitter Voltage	70	V
V _{ECO}	Emitter-Collector Voltage	7	V
PD _C	Detector Power Dissipation @ T _A = 25°C (Note 2)	150	mW
	Derate Above 25°C	1.47	mW/°C

Stresses exceeding those listed in the Maximum Ratings table may damage the device. If any of these limits are exceeded, device functionality should not be assumed, damage may occur and reliability may be affected.

2. Functional operation under these conditions is not implied. Permanent damage may occur if the device is subjected to conditions outside these ratings.

FODM100x Series

ELECTRICAL CHARACTERISTICS

$T_A = 25^\circ\text{C}$ unless otherwise specified.

INDIVIDUAL COMPONENT CHARACTERISTICS

Symbol	Parameter	Device	Test Conditions	Min	Typ	Max	Unit
EMITTER							
V_F	Forward Voltage	All	$I_F = 50\text{ mA}$	–	1.4	1.6	V
I_R	Reverse Current	All	$V_R = 4\text{ V}$	–	–	10	μA
DETECTOR							
BV_{CEO}	Breakdown Voltage Collector to Emitter	All	$I_C = 1\text{ mA}, I_F = 0$	70	–	–	V
BV_{ECO}	Emitter to Collector	All	$I_E = 0.1\text{ mA}, I_F = 0$	7	–	–	V
I_{CEO}	Collector Dark Current	All	$V_{CE} = 70\text{ V}, I_F = 0$	–	–	100	nA
C_{CE}	Capacitance	All	$V_{CE} = 0\text{ V}, f = 1\text{ MHz}$	–	5	–	pF

DC TRANSFER CHARACTERISTICS

Symbol	Parameter	Device	Test Conditions	Min	Typ	Max	Unit
CTR	DC Current Transfer Ratio	FODM1007	$I_F = 5\text{ mA}, V_{CE} = 5\text{ V}$	80	–	160	%
		FODM1008		130	–	260	
		FODM1009		200	–	400	
$V_{CE(SAT)}$	Saturation Voltage	All	$I_F = 10\text{ mA}, I_C = 1\text{ mA}$	–	–	0.3	V

AC TRANSFER CHARACTERISTICS

Symbol	Parameter	Device	Test Conditions	Min	Typ	Max	Unit
t_r	Rise Time (Non-Saturated)	All	$I_C = 2\text{ mA}, V_{CE} = 5\text{ V}, R_L = 100\ \Omega$	–	5.7	18.0	μs
t_f	Fall Time (Non-Saturated)	All	$I_C = 2\text{ mA}, V_{CE} = 5\text{ V}, R_L = 100\ \Omega$	–	8.5	18.0	

ISOLATION CHARACTERISTICS

Symbol	Parameter	Device	Test Conditions	Min	Typ	Max	Unit
V_{ISO}	Steady State Isolation Voltage	All	$T_A = 25^\circ\text{C}, \text{R.H.} < 50\%,$ $t = 1.0\text{ min.}, I_{I-O} \leq 20\ \mu\text{A}$	5,000	–	–	$V_{AC(RMS)}$

Product parametric performance is indicated in the Electrical Characteristics for the listed test conditions, unless otherwise noted. Product performance may not be indicated by the Electrical Characteristics if operated under different conditions.

FODM100x Series

TYPICAL PERFORMANCE CHARACTERISTICS

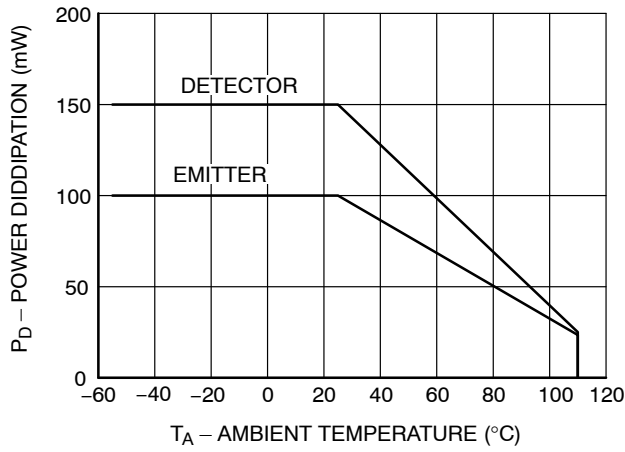

Figure 1. Power Dissipation vs. Ambient Temperature

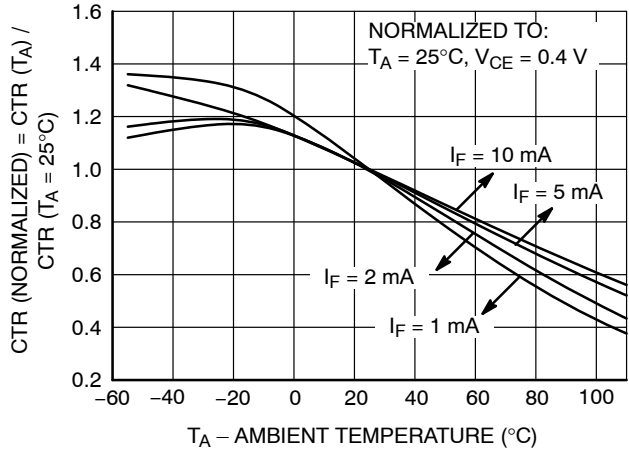

Figure 2. Saturated Normalized Current Transfer Ratio vs. Ambient temperature

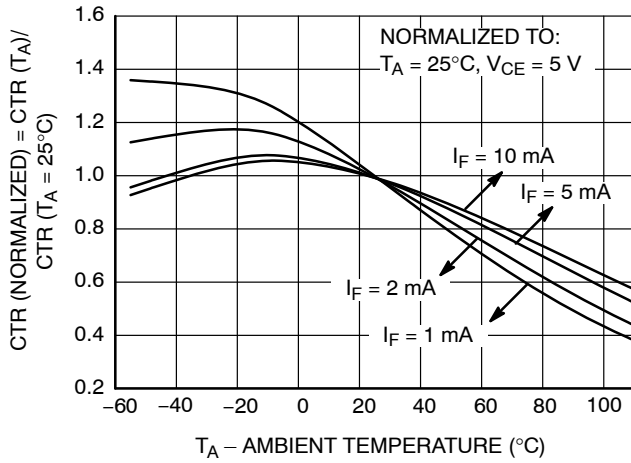

Figure 3. Non-Saturated Normalized Current Transfer Ratio vs. Ambient temperature

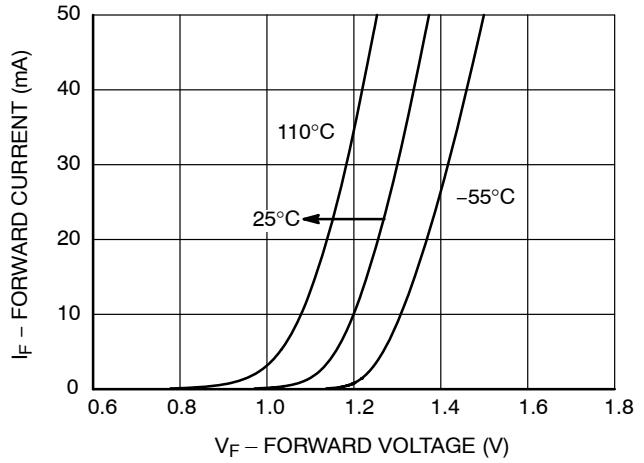

Figure 4. Forward Current vs. Forward Voltage

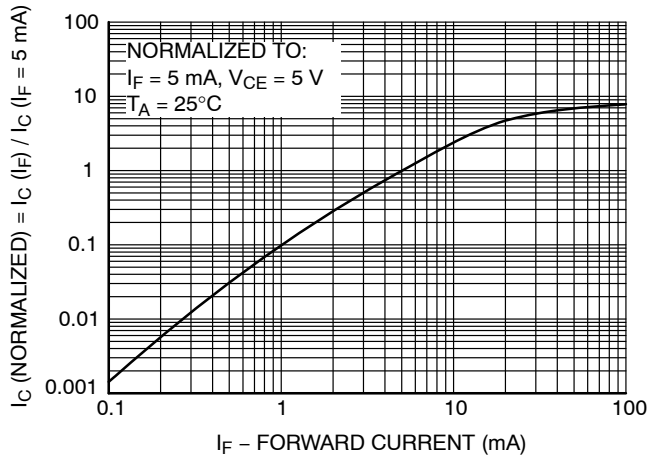

Figure 5. Normalized Current Collector vs. Forward Current

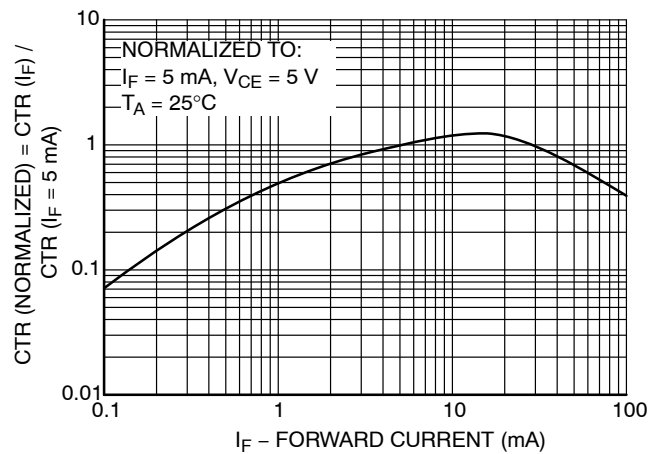

Figure 6. Normalized Current Transfer Ratio vs. Forward Current

FODM100x Series

TYPICAL PERFORMANCE CHARACTERISTICS (continued)

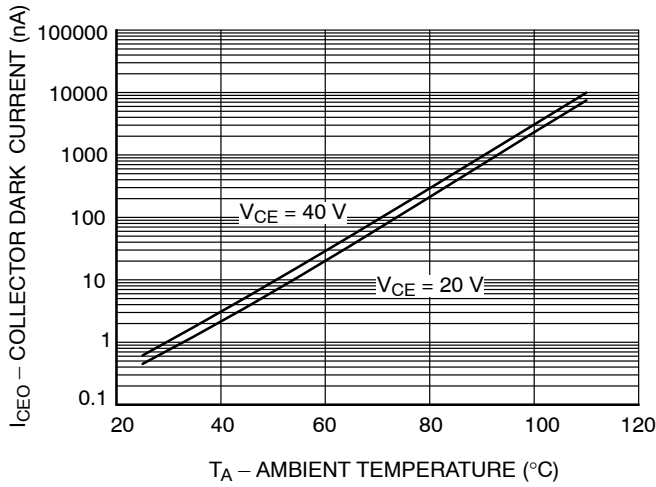

Figure 7. Collector Dark Current vs. Ambient Temperature

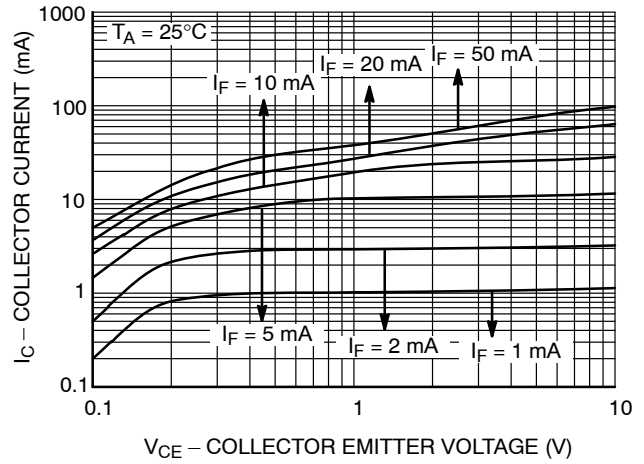

Figure 8. Collector Current vs. Collector Emitter Voltage

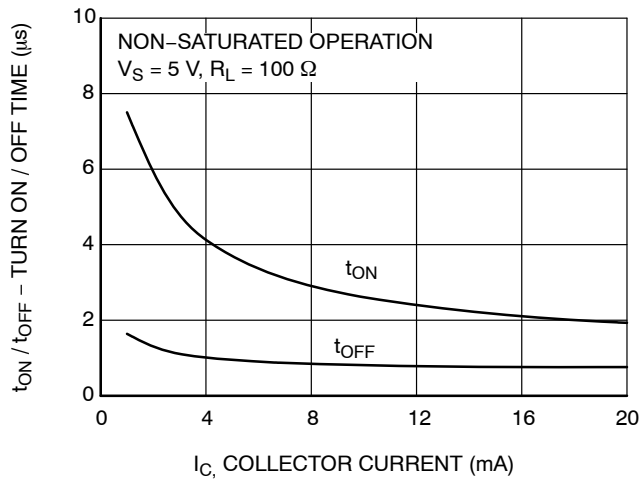

Figure 9. Turn On / Turn Off Time vs. Collector Current

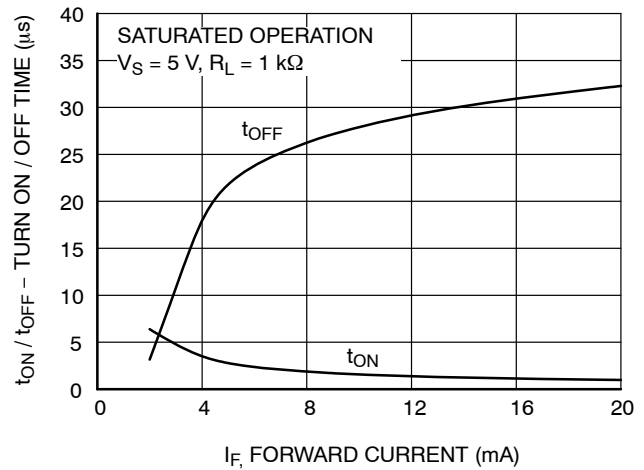

Figure 10. Turn On / Turn Off Time vs. Forward Current

FODM100x Series

REFLOW PROFILE

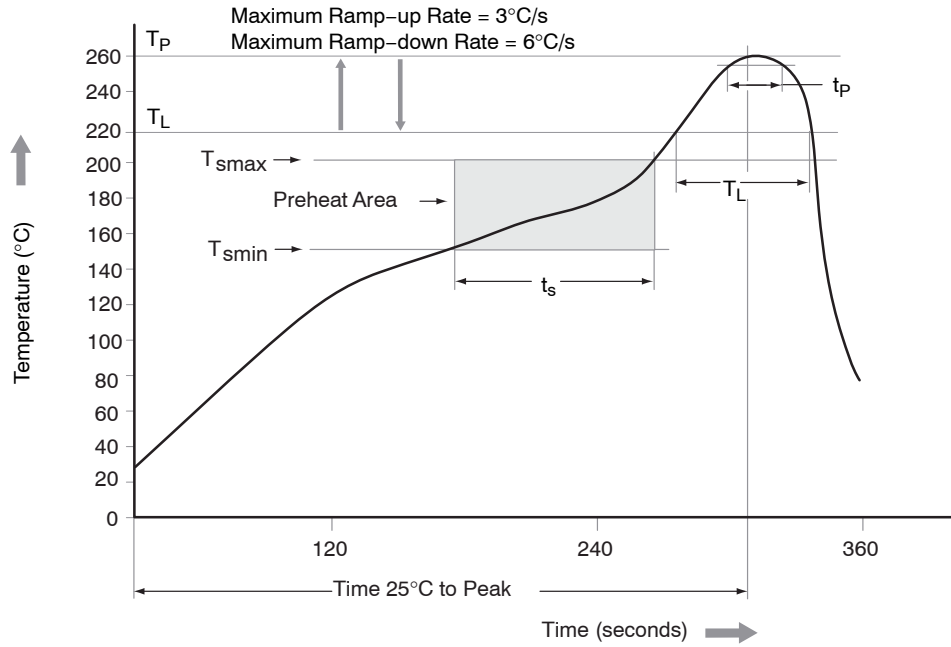

Figure 11. Reflow Profile

Table 1. REFLOW PROFILE

Profile Feature	Pb-Free Assembly Profile
Temperature Minimum (T_{smin})	150°C
Temperature Maximum (T_{smax})	200°C
Time (t_s) from (T_{smin} to T_{smax})	60 – 120 seconds
Ramp-up Rate (t_L to t_p)	3°C/second maximum
Liquidous Temperature (T_L)	217°C
Time (t_L) Maintained Above (T_L)	60 – 150 seconds
Peak Body Package Temperature	260°C +0°C / -5°C
Time (t_p) within 5°C of 260°C	30 seconds
Ramp-down Rate (T_P to T_L)	6°C/second maximum
Time 25°C to Peak Temperature	8 minutes maximum

FODM100x Series

ORDERING INFORMATION

Part Number	Package	Shipping†
FODM1007	Stretched Body SOP 4-Pin	100 Units / Tube
FODM1007R2	Stretched Body SOP 4-Pin	3000 / Tape & Reel
FODM1007V	Stretched Body SOP 4-Pin, DIN EN/IEC60747-5-5 Option	100 Units / Tube
FODM1007R2V	Stretched Body SOP 4-Pin, DIN EN/IEC60747-5-5 Option	3000 / Tape & Reel

†For information on tape and reel specifications, including part orientation and tape sizes, please refer to our Tape and Reel Packaging Specifications Brochure, BRD8011/D.

NOTE: The product orderable part number system listed in this table also applies to the FODM1008, FODM1009 products.

MECHANICAL CASE OUTLINE

PACKAGE DIMENSIONS

ON Semiconductor®



SSOP4 / LSOP04
CASE 565BH
ISSUE O

DATE 31 JAN 2017

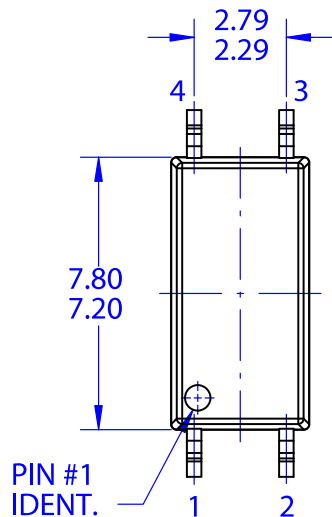

TOP VIEW

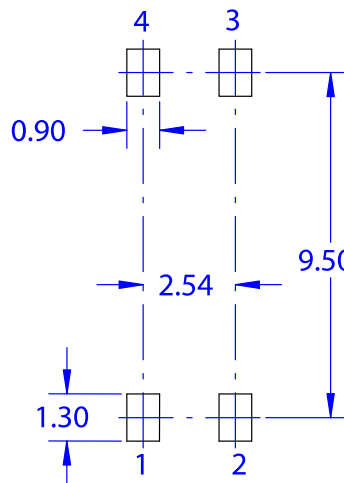

LAND PATTERN RECOMMENDATION

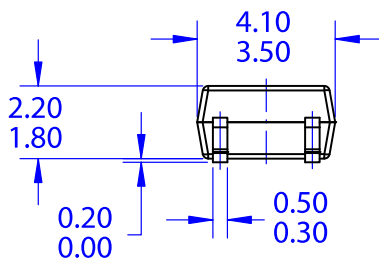

FRONT VIEW

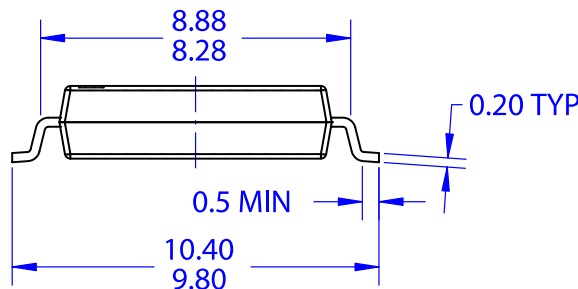

SIDE VIEW

NOTES:

- A. NO INDUSTRY STANDARD APPLIES TO THIS PACKAGE
- B. ALL DIMENSIONS ARE IN MILLIMETERS
- C. DIMENSIONS DO NOT INCLUDE MOLD FLASH OR BURRS

DOCUMENT NUMBER:	98AON13754G	Electronic versions are uncontrolled except when accessed directly from the Document Repository. Printed versions are uncontrolled except when stamped "CONTROLLED COPY" in red.
DESCRIPTION:	SSOP4 / LSOP04	PAGE 1 OF 1

ON Semiconductor and are trademarks of Semiconductor Components Industries, LLC dba ON Semiconductor or its subsidiaries in the United States and/or other countries. ON Semiconductor reserves the right to make changes without further notice to any products herein. ON Semiconductor makes no warranty, representation or guarantee regarding the suitability of its products for any particular purpose, nor does ON Semiconductor assume any liability arising out of the application or use of any product or circuit, and specifically disclaims any and all liability, including without limitation special, consequential or incidental damages. ON Semiconductor does not convey any license under its patent rights nor the rights of others.

onsemi, **Onsemi**, and other names, marks, and brands are registered and/or common law trademarks of Semiconductor Components Industries, LLC dba "**onsemi**" or its affiliates and/or subsidiaries in the United States and/or other countries. **onsemi** owns the rights to a number of patents, trademarks, copyrights, trade secrets, and other intellectual property. A listing of **onsemi**'s product/patent coverage may be accessed at www.onsemi.com/site/pdf/Patent-Marking.pdf. **onsemi** reserves the right to make changes at any time to any products or information herein, without notice. The information herein is provided "as-is" and **onsemi** makes no warranty, representation or guarantee regarding the accuracy of the information, product features, availability, functionality, or suitability of its products for any particular purpose, nor does **onsemi** assume any liability arising out of the application or use of any product or circuit, and specifically disclaims any and all liability, including without limitation special, consequential or incidental damages. Buyer is responsible for its products and applications using **onsemi** products, including compliance with all laws, regulations and safety requirements or standards, regardless of any support or applications information provided by **onsemi**. "Typical" parameters which may be provided in **onsemi** data sheets and/or specifications can and do vary in different applications and actual performance may vary over time. All operating parameters, including "Typicals" must be validated for each customer application by customer's technical experts. **onsemi** does not convey any license under any of its intellectual property rights nor the rights of others. **onsemi** products are not designed, intended, or authorized for use as a critical component in life support systems or any FDA Class 3 medical devices or medical devices with a same or similar classification in a foreign jurisdiction or any devices intended for implantation in the human body. Should Buyer purchase or use **onsemi** products for any such unintended or unauthorized application, Buyer shall indemnify and hold **onsemi** and its officers, employees, subsidiaries, affiliates, and distributors harmless against all claims, costs, damages, and expenses, and reasonable attorney fees arising out of, directly or indirectly, any claim of personal injury or death associated with such unintended or unauthorized use, even if such claim alleges that **onsemi** was negligent regarding the design or manufacture of the part. **onsemi** is an Equal Opportunity/Affirmative Action Employer. This literature is subject to all applicable copyright laws and is not for resale in any manner.

PUBLICATION ORDERING INFORMATION

LITERATURE FULFILLMENT:

Email Requests to: orderlit@onsemi.com

onsemi Website: www.onsemi.com

TECHNICAL SUPPORT

North American Technical Support:
Voice Mail: 1 800-282-9855 Toll Free USA/Canada
Phone: 011 421 33 790 2910

Europe, Middle East and Africa Technical Support:

Phone: 00421 33 790 2910

For additional information, please contact your local Sales Representative

X-ON Electronics

Largest Supplier of Electrical and Electronic Components

Click to view similar products for [Transistor Output Optocouplers](#) category:

Click to view products by [ON Semiconductor](#) manufacturer:

Other Similar products are found below :

[LTV-814S-TA](#) [LTV-824HS](#) [66095-001](#) [6N136-X017T](#) [MCT6-X007](#) [MOC8101-X017T](#) [PS2561A-1-W-A](#) [PS2561B-1-L-A](#) [PS2561L-1-V-A](#)
[MRF658](#) [IL755-1X007](#) [ILD2-X006](#) [ILD74-X001](#) [ILQ615-2X017](#) [ILQ615-3X016](#) [LDA102S](#) [LDA110S](#) [SFH615AGR-X007T](#) [PS2561-1-V-](#)
[W-A](#) [PS2561AL-1-V-A](#) [PS2561L1-1-L-A](#) [PS2581L2-A](#) [PS2701A-1-F3-P-A](#) [PS2801-1-F3-P-A](#) [PS2911-1-L-AX](#) [CNY17-2X017](#) [CNY17-](#)
[4X001](#) [CNY17-4X017](#) [CNY17F-1X007](#) [CNY17F-2X017](#) [CNY17F-4X001](#) [CNY17G-1](#) [LTV-214](#) [LTV-702VB](#) [LTV-733S](#) [LTV-816S-TA](#)
[LTV-825S](#) [TCET1113](#) [TCET2100](#) [4N25-X007T](#) [IL215AT](#) [ILD615-1X007](#) [ILQ2-X007](#) [VOS615A-2T](#) [WPPC-A11066AA](#) [WPPC-](#)
[A11066AD](#) [WPPC-A11084ASS](#) [WPPC-A21068AA](#) [WPPC-D11066AA](#) [WPPC-D21068ED](#)