

IntelliMAX™ Advanced Load Management Products

FPF2100 - FPF2107

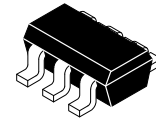

SOT23-5
CASE 527AH

Description

The FPF2100 through FPF2107 is a family of load switches which provide full protection to systems and loads which may encounter large current conditions. These devices contain a 0.125 Ω current-limited P-channel MOSFET which can operate over an input voltage range of 1.8 – 5.5 V. Switch control is by a logic input (ON) capable of interfacing directly with low voltage control signals. Each part contains thermal shutdown protection which shuts off the switch to prevent damage to the part when a continuous over-current condition causes excessive heating.

When the switch current reaches the current limit, the part operates in a constant-current mode to prohibit excessive currents from causing damage. For the FPF2100–FPF2102 and FPF2104–FPF2106, if the constant current condition still persists after 10 ms, these parts will shut off the switch and pull the fault signal pin (FLAGB) low. The FPF2100, FPF2101, FPF2104 and FPF2105, have an auto-restart feature which will turn the switch on again after 160 ms if the ON pin is still active. The FPF2102 and FPF2106 do not have this auto-restart feature so the switch will remain off until the ON pin is cycled. For the FPF2103 and FPF2107, a current limit condition will immediately pull the fault signal pin low and the part will remain in the constant-current mode until the switch current falls below the current limit. For the FPF2100 through FPF2103, the minimum current limit is 200 mA while that for the FPF2104 through FPF2107 is 400 mA.

These parts are available in a space-saving 5 pin SOT23 package.

Features

- 1.8 to 5.5 V Input Voltage Range
- Controlled Turn-On
- 200 mA and 400 mA Current Limit Options
- Under-Voltage Lockout
- Thermal Shutdown
- < 1 μA Shutdown Current
- Auto Restart
- Fast Current Limit Response Time
 - ◆ 3 μs to Moderate Over Currents
 - ◆ 20 ns to Hard Shorts
- Fault Blanking
- These Devices are Pb-Free, Halogen Free/BFR Free and are RoHS Compliant

MARKING DIAGRAM

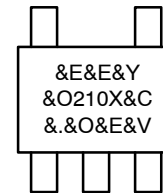

- &E = Designates Space
- &Y = Binary Calendar Year Coding Scheme
- &O = Plant Code identifier
- 210X = Device Specific Code
X = 0, 1, 2, 3, 4, 5, 6, 7
- &C = Single digit Die Run Code
- &. = Pin One Dot
- &V = Eight-Week Binary Datecoding Scheme

ORDERING INFORMATION

See detailed ordering and shipping information on page 11 of this data sheet.

Applications

- PDAs
- Cell Phones
- GPS Devices
- MP3 Players
- Digital Cameras
- Peripheral Ports
- Hot Swap Supplies

FPF2100 - FPF2107

Typical Application Circuit

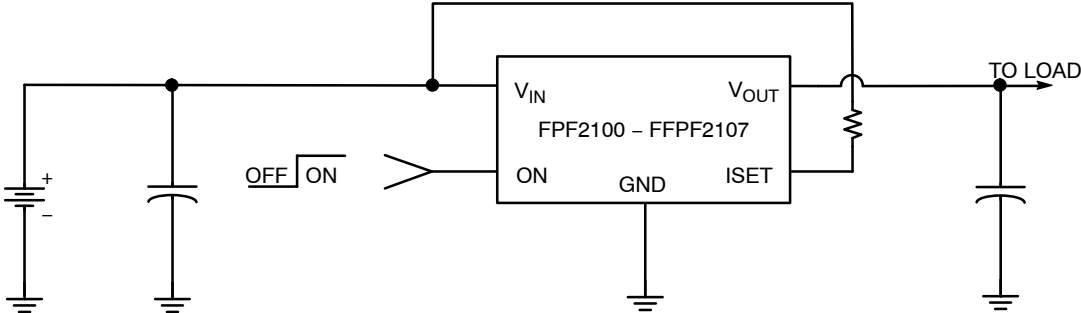

Figure 1. Typical Application

Functional Block Diagram

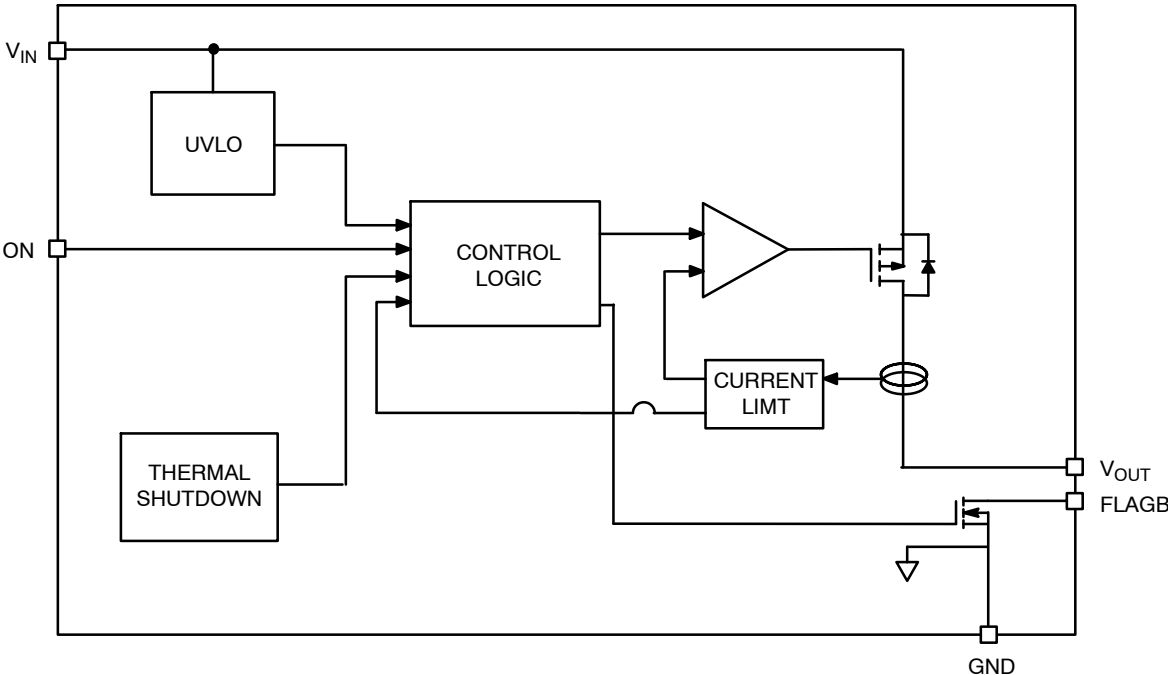

Figure 2. Block Diagram

FPF2100 – FPF2107

Pin Configuration

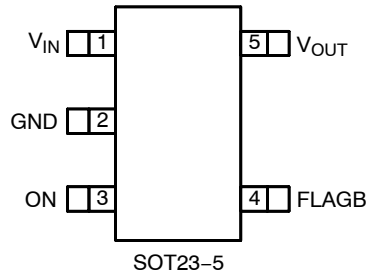

Figure 3. Pin Assignment

PIN DESCRIPTIONS

Name	Type	Description
1	V _{IN}	Supply Input: Input to the power switch and the supply voltage for the IC
2	GND	Ground
3	ON	ON Control Input
4	FLAGB	Fault Output: Active LO, open drain output which indicates an over-current supply, under-voltage or over-temperature state
5	V _{OUT}	Switch Output: Output of the power switch

ABSOLUTE MAXIMUM RATINGS

Symbol	Parameter	Min	Max	Unit	
V _{IN}	V _{IN} , V _{OUT} , ON, FLAGB to GND	-0.3	6.0	V	
P _D	Power Dissipation at T _A = 25°C (Note 1)	-	667	mW	
T _J	Operating Junction Temperature	-40	125	°C	
T _{STG}	Storage Temperature	-65	150	°C	
θ _{JA}	Thermal Resistance, Junction to Ambient	-	150	°C/W	
ESD	Electrostatic Discharge Protection	HBM	4000	-	V
		MM	400	-	

Stresses exceeding those listed in the Maximum Ratings table may damage the device. If any of these limits are exceeded, device functionality should not be assumed, damage may occur and reliability may be affected.

1. Package power dissipation on 1 square inch pad, 2 oz. copper board.

RECOMMENDED OPERATING RANGE

Symbol	Parameter	Min	Max	Unit
V _{IN}	Input Voltage	1.8	5.5	V
T _A	Ambient Operating Temperature	-40	85	°C

Functional operation above the stresses listed in the Recommended Operating Ranges is not implied. Extended exposure to stresses beyond the Recommended Operating Ranges limits may affect device reliability.

FPF2100 – FPF2107

ELECTRICAL CHARACTERISTICS

$V_{IN} = 1.8$ to 5.5 V, $T_A = -40$ to $+85^\circ\text{C}$ unless otherwise noted. Typical values are at $V_{IN} = 3.3$ V and $T_A = 25^\circ\text{C}$.

Symbol	Parameter	Test Condition	Min	Typ	Max	Unit	
Basic Operation							
V_{IN}	Operating Voltage		1.8	–	5.5	V	
I_Q	Quiescent Current	$I_{OUT} = 0$ mA V_{ON} active	$V_{IN} = 1.8$ to 3.3 V	–	95	–	μA
			$V_{IN} = 3.3$ to 5.5 V	–	110	200	
I_{SHDN}	Shutdown Current		–	–	1	μA	
$I_{LATCHOFF}$	Latch-Off Current (Note 2)	$V_{ON} = V_{IN}$, After an Over-Current Fault	–	50	–	μA	
R_{ON}	On-Resistance	$V_{IN} = 3.3$ V, $I_{OUT} = 50$ mA, $T_A = 25^\circ\text{C}$	–	125	160	m Ω	
		$V_{IN} = 3.3$ V, $I_{OUT} = 50$ mA, $T_A = 85^\circ\text{C}$	–	150	200		
		$V_{IN} = 3.3$ V, $I_{OUT} = 50$ mA, $T_A = -40^\circ\text{C}$ to $+85^\circ\text{C}$	65	–	200		
V_{IH}	ON Input Logic High Voltage	$V_{IN} = 1.8$ V	0.75	–	–	V	
		$V_{IN} = 5.5$ V	1.30	–	–		
V_{IL}	ON Input Logic Low Voltage	$V_{IN} = 1.8$ V	–	–	0.5	V	
		$V_{IN} = 5.5$ V	–	–	1.0		
	ON Input Leakage	$V_{ON} = V_{IN}$ or GND	–	–	1	μA	
I_{SWOFF}	Off Switch Leakage	$V_{ON} = 0$ V, $V_{OUT} = 0$ V @ $V_{IN} = 5.5$ V, $T_A = 85^\circ\text{C}$	–	–	1	μA	
		$V_{ON} = 0$ V, $V_{OUT} = 0$ V @ $V_{IN} = 3.3$ V, $T_A = 25^\circ\text{C}$	–	10	100	nA	
	FLAGB Output Logic Low Voltage	$V_{IN} = 5$ V, $I_{SINK} = 10$ mA	–	0.1	0.2	V	
		$V_{IN} = 1.8$ V, $I_{SINK} = 10$ mA	–	0.15	0.3		
	FLAGB Output High Leakage Current	$V_{IN} = 5$ V, Switch On	–	–	1	μA	

Protections

I_{LIM}	Current Limit	$V_{IN} = 3.3$ V, $V_{OUT} = 3.0$ V	FPF2100, FPF2101, FPF2102, FPF2103	200	300	400	mA
			FPF2104, FPF2105, FPF2106, FPF2107	400	600	800	
	Thermal Shutdown	Shutdown Threshold	–	140	–	$^\circ\text{C}$	
		Return from Shutdown	–	130	–		
		Hysteresis	–	10	–		
UVLO	Under-Voltage Shutdown	V_{IN} Increasing	1.5	1.6	1.7	V	
	Under-Voltage Shutdown Hysteresis		–	47	–	mV	

Dynamic

t_{ON}	Turn On Time	$R_L = 500$ Ω , $C_L = 0.1$ μF	–	25	–	μs
t_{OFF}	Turn Off Time	$R_L = 500$ Ω , $C_L = 0.1$ μF	–	50	–	μs
t_R	V_{OUT} Rise Time	$R_L = 500$ Ω , $C_L = 0.1$ μF	–	12	–	μs
t_F	V_{OUT} Fall Time	$R_L = 500$ Ω , $C_L = 0.1$ μF	–	136	–	μs
t_{BLANK}	Over Current Blanking Time	FPF2100, FPF2101, FPF2102, FPF2104, FPF2105, FPF2106	5	10	20	ms
t_{RSTRT}	Auto-Restart Time	FPF2100, FPF2101, FPF2104, FPF2105	80	160	320	ms
	Short-Circuit Response Time	$V_{IN} = V_{ON} = 3.3$ V Moderate Over-Current Condition	–	3	–	μs
		$V_{IN} = V_{OUT} = 3.3$ V, Hard Short	–	20	–	ns

Product parametric performance is indicated in the Electrical Characteristics for the listed test conditions, unless otherwise noted. Product performance may not be indicated by the Electrical Characteristics if operated under different conditions.

2. Applicable only to FPF2102 and FPF2106. Latchoff current does not include current flowing into FLAGB.

TYPICAL CHARACTERISTICS

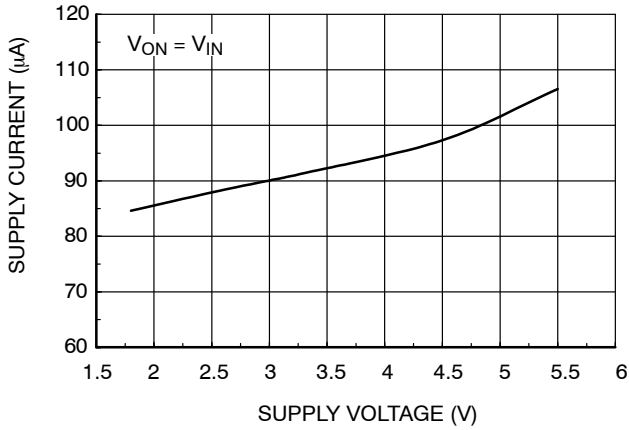

Figure 4. Quiescent Current vs. Input Voltage

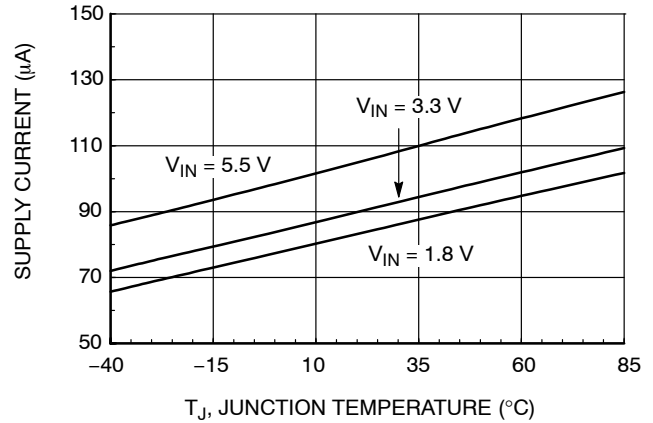

Figure 5. Quiescent Current vs. Temperature

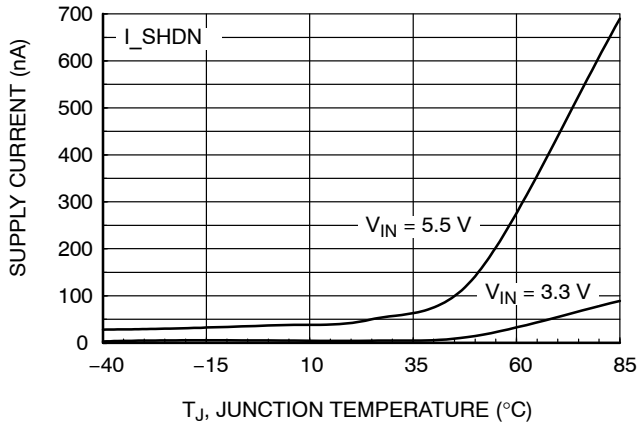

Figure 6. I_{SHUTDOWN} Current vs. Temperature

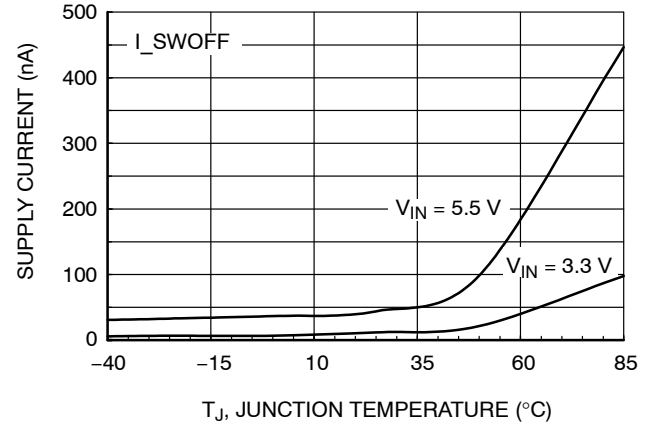

Figure 7. I_{SWITCH-OFF} Current vs. Temperature

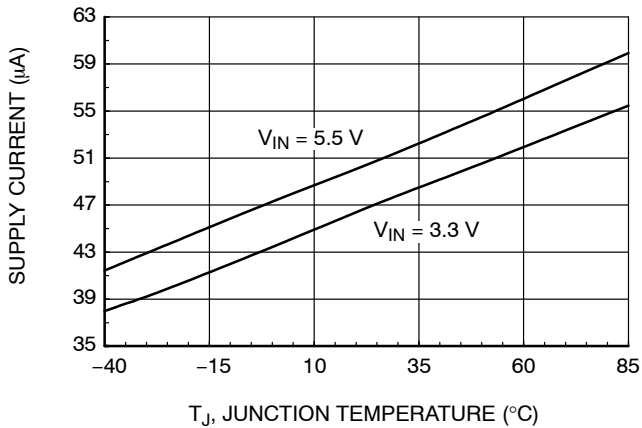

Figure 8. I_{LATCHOFF} vs. Temperature

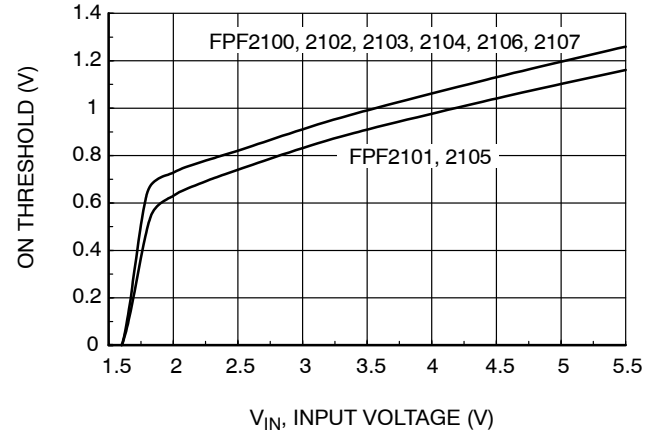

Figure 9. V_{IH} vs. V_{IN}

FPF2100 – FPF2107

TYPICAL CHARACTERISTICS (continued)

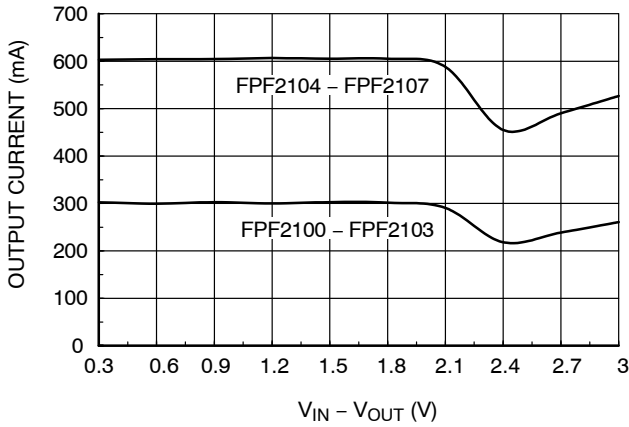

Figure 10. Current Limit vs. Output Voltage

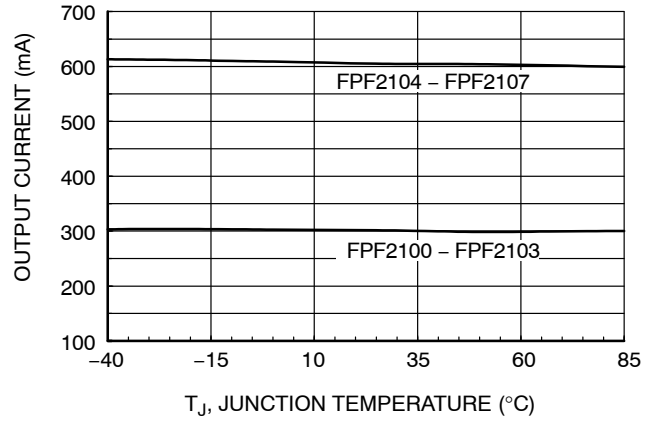

Figure 11. Current Limit vs. Temperature

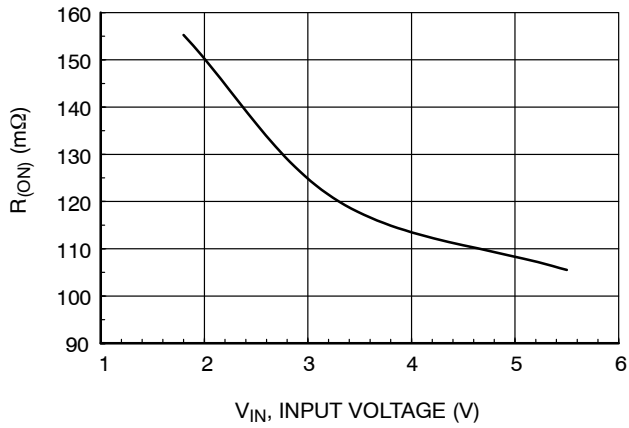

Figure 12. $R_{(ON)}$ vs. V_{IN}

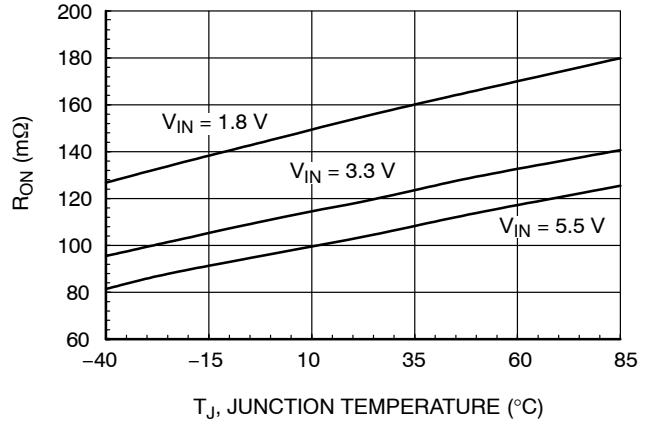

Figure 13. $R_{(ON)}$ vs. Temperature

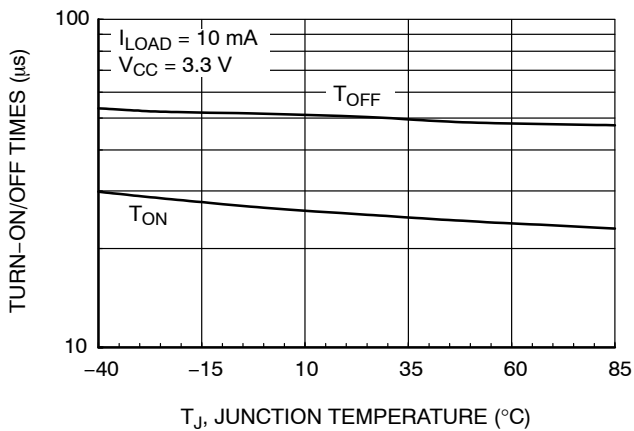

Figure 14. T_{ON} / T_{OFF} vs. Temperature

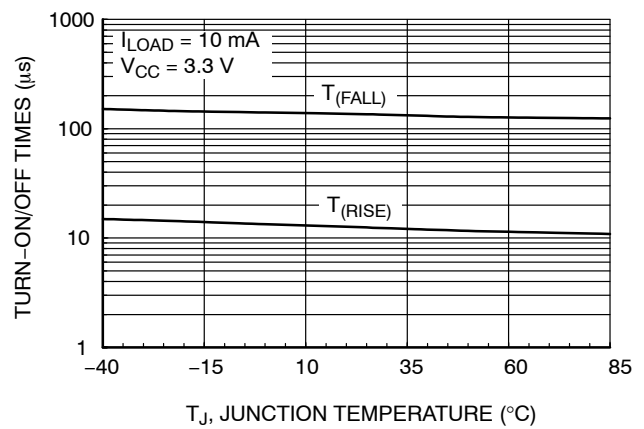

Figure 15. T_{RISE} / T_{FALL} vs. Temperature

TYPICAL CHARACTERISTICS (continued)

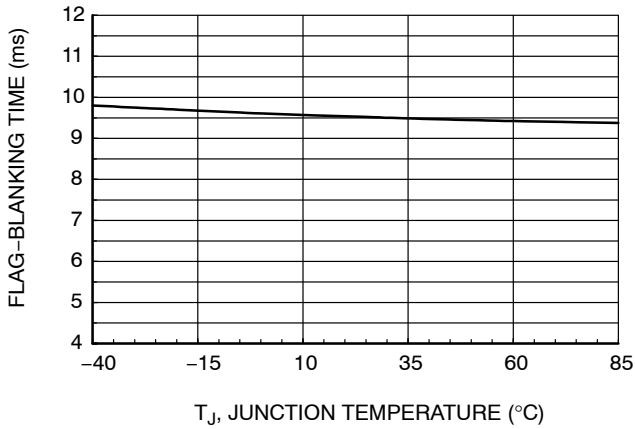

Figure 16. T_{BLANK} vs. Temperature

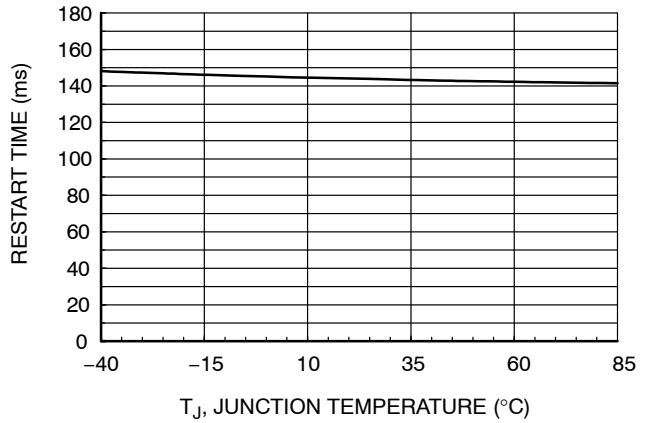

Figure 17. T_{RESTART} vs. Temperature

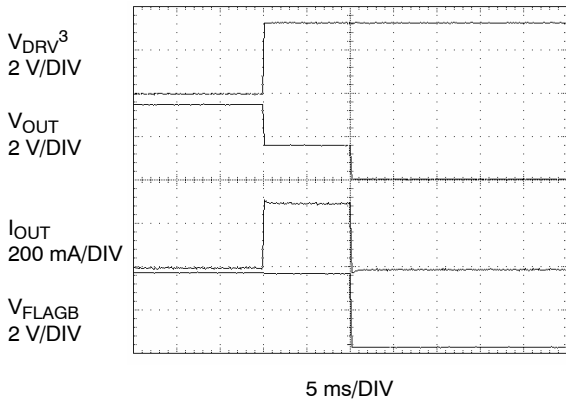

Figure 18. T_{BLANK} Response

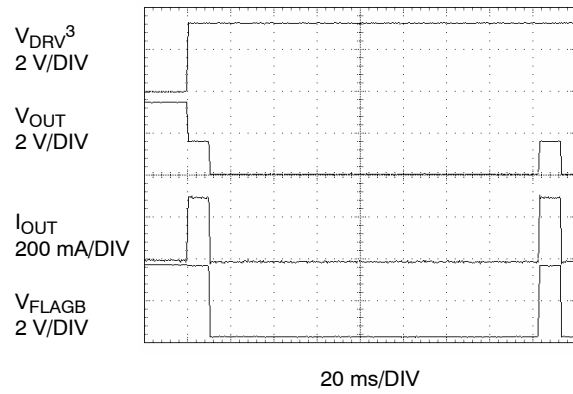

Figure 19. T_{RESTART} Response

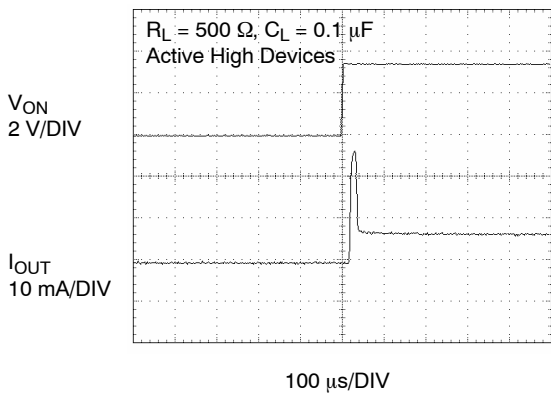

Figure 20. T_{ON} Response

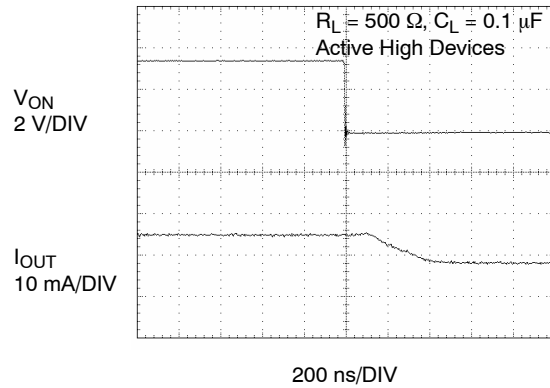

Figure 21. T_{OFF} Response

TYPICAL CHARACTERISTICS (continued)

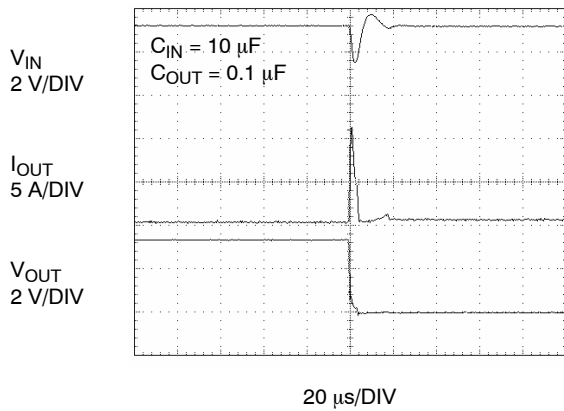

Figure 22. Short Circuit Response Time (Output Shorted to GND)

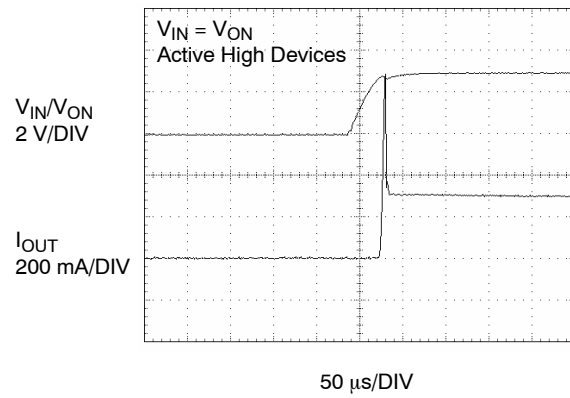

Figure 23. Current Limit Response (Switch Power Up to Hard Short)

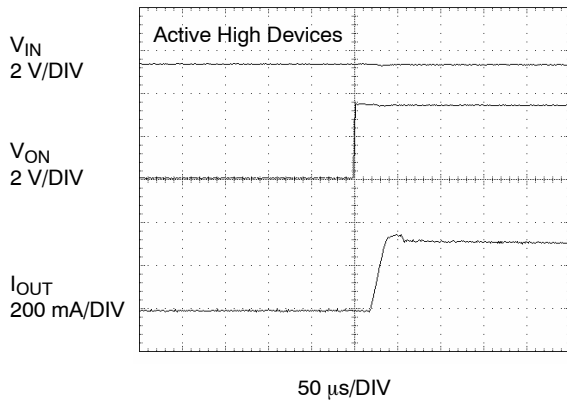

Figure 24. Current Limit Response Time (Output Shorted to GND by 10 Ω , Moderate Short)

NOTE: V_{DRV} signal forces the device to go into over-current condition.

Description of Operation

The FPF2100–FPF2107 are current limited switches that protect systems and loads which can be damaged or disrupted by the application of high currents. The core of each device is a 0.125 Ω P-channel MOSFET and a controller capable of functioning over a wide input operating range of 1.8 V – 5.5 V. The controller protects against system malfunctions through current limiting, under-voltage lockout and thermal shutdown. The current limit is preset for either 200 mA or 400 mA.

On/Off Control

The ON pin controls the state of the switch. Active HI and LO versions are available. Refer to the Ordering Information for details. Activating ON continuously holds the switch in the on state so long as there is no fault. For all versions, an under-voltage on V_{IN} or a junction temperature in excess of 150°C overrides the ON control to turn off the switch. In addition, excessive currents will cause the switch to turn off in FPF2100–FPF2102 and FPF2104–FPF2107. The FPF2100, FPF2101, FPF2104 and FPF2105 have an Auto-Restart feature which will automatically turn the switch on again after 160 ms. For the FPF2102 and FPF2106, the ON pin must be toggled to turn-on the switch again. The FPF2103 and FPF2107 do not turn off in response to a over current condition but instead remain operating in a constant current mode so long as ON is active and the thermal shutdown or under-voltage lockout have not activated.

Fault Reporting

Upon the detection of an over-current, an input under-voltage, or an over-temperature condition, the FLAGB signals the fault mode by activating LO. For the FPF2100–FPF2102 and FPF2104–FPF2106, the FLAGB goes LO at the end of the blanking time while FLAGB goes LO immediately for the FPF2103 and FPF2107. FLAGB remains LO through the Auto-Restart Time for the FPF2100, FPF2101 FPF2104 and FPF2105. For the FPF2102 and FPF2106, FLAGB is latched LO and ON must be toggled to release it. With the FPF2103 and FPF2107, FLAGB is LO during the faults and immediately returns HI at the end of the fault condition. FLAGB is an open-drain MOSFET which requires a pull-up resistor between V_{IN} and FLAGB. During shutdown, the pull-down on FLAGB is disabled to reduce current draw from the supply.

Current Limiting

The current limit ensures that the current through the switch doesn't exceed a maximum value while not limiting at less than a minimum value. For the FPF2100–FPF2103 the minimum current is 200 mA and the maximum current is 400 mA and for the FPF2104–FPF2107 the minimum current is 400mA and the maximum current is 800 mA. The FPF2100–FPF2103 have a blanking time of 10 ms, nominally, during which the switch will act as a constant current source. At the end of the blanking time, the switch will be turned-off and the FLAGB pin will activate to indicate that current limiting has occurred. The FPF2103 and FPF2107 have no current limit blanking period so immediately upon a current limit condition FLAGB is activated. These parts will remain in a constant current state until the ON pin is deactivated or the thermal shutdown turns-off the switch.

Reverse Voltage

If the voltage at the V_{OUT} pin is larger than the V_{IN} pin, large currents may flow and can cause permanent damage to the device. FPF2100–FPF2107 is designed to control current flow from V_{IN} to V_{OUT} .

Under-Voltage Lockout

The under-voltage lockout turns-off the switch if the input voltage drops below the under-voltage lockout threshold. With the ON pin active the input voltage rising above the under-voltage lockout threshold will cause a controlled turn on of the switch which limits current over-shoots.

Thermal Shutdown

The thermal shutdown protects the part from internally or externally generated excessive temperatures. During an over-temperature condition the FLAGB is activated and the switch is turned-off. The switch automatically turns-on again if the temperature of the die drops below the threshold temperature.

FPF2100 – FPF2107

APPLICATIONS INFORMATION

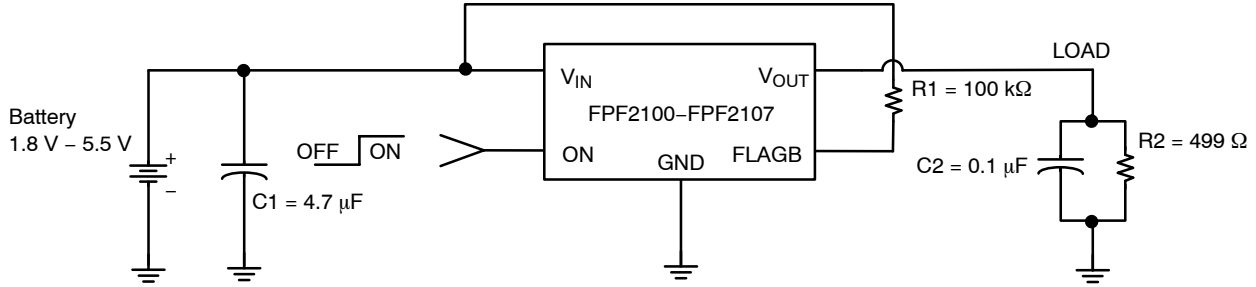

Figure 25. Typical Application

Input Capacitor

To limit the voltage drop on the input supply caused by transient in-rush currents when the switch turns-on into a discharged load capacitor or a short-circuit, a capacitor needs to be placed between V_{IN} and GND. A 4.7 mF ceramic capacitor, C_{IN} , must be placed close to the V_{IN} pin. A higher value of C_{IN} can be used to further reduce the voltage drop experienced as the switch is turned on into a large capacitive load.

Output Capacitor

A 0.1 μ F capacitor C_{OUT} , should be placed between V_{OUT} and GND. This capacitor will prevent parasitic board inductances from forcing V_{OUT} below GND when the switch turns-off. For the FPF2100–FPF2102 and the FPF2104–FPF2106, the total output capacitance needs to be kept below a maximum value, $C_{OUT(max)}$, to prevent the part from registering an over-current condition and turning off the switch. The maximum output capacitance can be determined from the following formula,

$$C_{OUT(max)} = \frac{I_{LIM(max)} \times t_{BLANK(min)}}{V_{IN}} \quad (\text{eq. 1})$$

Due to the integral body diode in the PMOS switch, a C_{IN} greater than C_{OUT} is highly recommended. A C_{OUT} greater than C_{IN} can cause V_{OUT} to exceed V_{IN} when the system supply is removed. This could result in current flow through the body diode from V_{OUT} to V_{IN} .

Power Dissipation

During normal operation as a switch, the power dissipation is small and has little effect on the operating temperature of the part. The parts with the higher current limits will dissipate the most power and that will only typically be,

$$P = (I_{LIM})^2 \times R_{DS} = (0.2)^2 \times 0.125 = 80 \text{ mW} \quad (\text{eq. 2})$$

If the part goes into current limit the maximum power dissipation will occur when the output is shorted to ground. For the FPF2100, FPF2101, FPF2104 and FPF2105, the power dissipation will scale by the Auto-Restart Time, t_{RSTRT} , and the Over Current Blanking Time, t_{BLANK} , so that the maximum power dissipated is typically,

$$P(\text{max}) = \frac{t_{BLANK}}{t_{RESTART} + t_{BLANK}} \times V_{IN(max)} \times I_{LIM(max)}$$

$$= \frac{10}{10 + 160} \times 5.5 \times 0.8 = 260 \text{ mW} \quad (\text{eq. 3})$$

When using the FPF2102 and FPF2106 attention must be given to the manual resetting of the part. Continuously resetting the part at a high duty cycle when a short on the output is present can cause the temperature of the part to increase. The junction temperature will only be allowed to increase to the thermal shutdown threshold. Once this temperature has been reached, toggling ON will not turn on the switch until the junction temperature drops. For the FPF2103 and FPF2107, a short on the output will cause the part to operate in a constant current state dissipating a worst case power as calculated in Eq. 3 until the thermal shutdown activates. It will then cycle in and out of thermal shutdown so long as the ON pin is active and the short is present.

Board Layout

For best performance, all traces should be as short as possible. To be most effective, the input and output capacitors should be placed close to the device to minimize the effects that parasitic trace inductances may have on normal and short-circuit operation. Using wide traces for V_{IN} , V_{OUT} and GND will help minimize parasitic electrical effects along with minimizing the case to ambient thermal impedance.

FPF2100 – FPF2107

ORDERING INFORMATION

Part Number	Current Limit [mA]	Current Limit Blanking Time [ms]	Auto Restart Time [ms]	On Pin Activity	Top Mark	Shipping [†]
FPF2100	200	10	160	Active HI	2100	3000 / Tape & Reel
FPF2101	200	10	160	Active LO	2101	3000 / Tape & Reel
FPF2102	200	10	NA	Active HI	2102	3000 / Tape & Reel
FPF2103	200	0	NA	Active HI	2103	3000 / Tape & Reel
FPF2104	400	10	160	Active HI	2104	3000 / Tape & Reel
FPF2105	400	10	160	Active LO	2105	3000 / Tape & Reel
FPF2106	400	10	NA	Active HI	2106	3000 / Tape & Reel
FPF2107	400	0	NA	Active HI	2107	3000 / Tape & Reel

[†]For information on tape and reel specifications, including part orientation and tape sizes, please refer to our Tape and Reel Packaging Specifications Brochure, BRD8011/D

IntelliMAX is trademark of Semiconductor Components Industries, LLC dba "onsemi" or its affiliates and/or subsidiaries in the United States and/or other countries.

MECHANICAL CASE OUTLINE PACKAGE DIMENSIONS

ON Semiconductor®



SOT-23, 5 Lead CASE 527AH ISSUE A

DATE 09 JUN 2021



NOTES:

1. DIMENSIONING AND TOLERANCING PER ASME Y14.5M, 1989A
2. CONTROLLING DIMENSION: MILLIMETERS
3. MAXIMUM LEAD THICKNESS INCLUDES LEAD FINISH THICKNESS. MINIMUM LEAD THICKNESS IS THE MINIMUM THICKNESS OF THE BASE MATERIAL.
4. DIMENSIONS D AND E1 DO NOT INCLUDE MOLD FLASH, PROTRUSIONS, OR GATE BURRS. MOLD FLASH, PROTRUSIONS, OR GATE BURRS SHALL NOT EXCEED 0.25 PER SIDE. D AND E1 DIMENSIONS ARE DETERMINED AT DATUM D.
5. DIMENSION 'b' DOES NOT INCLUDE DAMBAR PROTRUSION. ALLOWABLE DAMBAR PROTRUSION SHALL BE 0.08mm TOTAL IN EXCESS OF THE 'b' DIMENSION AT MAXIMUM MATERIAL CONDITION. MINIMUM SPACE BETWEEN PROTRUSION AND AN ADJACENT LEAD SHALL NOT BE LESS THAN 0.07mm.



DIM	MILLIMETERS		
	MIN.	NOM.	MAX.
A	0.90	—	1.45
A1	0.00	—	0.15
A2	0.90	1.15	1.30
b	0.30	—	0.50
c	0.08	—	0.22
D	2.90 BSC		
E	2.80 BSC		
E1	1.60 BSC		
e	0.95 BSC		
L	0.30	0.45	0.60
L1	0.60 REF		
L2	0.25 REF		
theta	0°	4°	8°
theta1	0°	10°	15°
theta2	0°	10°	15°

GENERIC MARKING DIAGRAM*



XXX = Specific Device Code
M = Date Code

*This information is generic. Please refer to device data sheet for actual part marking. Pb-Free indicator, "G" or microdot "•", may or may not be present. Some products may not follow the Generic Marking.



For additional information on our Pb-Free strategy and soldering details, please download the ON Semiconductor Soldering and Mounting Techniques Reference Manual, SOLDERRM/D.

DOCUMENT NUMBER:	98AON34320E	Electronic versions are uncontrolled except when accessed directly from the Document Repository. Printed versions are uncontrolled except when stamped "CONTROLLED COPY" in red.
DESCRIPTION:	SOT-23, 5 LEAD	PAGE 1 OF 1

ON Semiconductor and ON are trademarks of Semiconductor Components Industries, LLC dba ON Semiconductor or its subsidiaries in the United States and/or other countries. ON Semiconductor reserves the right to make changes without further notice to any products herein. ON Semiconductor makes no warranty, representation or guarantee regarding the suitability of its products for any particular purpose, nor does ON Semiconductor assume any liability arising out of the application or use of any product or circuit, and specifically disclaims any and all liability, including without limitation special, consequential or incidental damages. ON Semiconductor does not convey any license under its patent rights nor the rights of others.

onsemi, **Onsemi**, and other names, marks, and brands are registered and/or common law trademarks of Semiconductor Components Industries, LLC dba "**onsemi**" or its affiliates and/or subsidiaries in the United States and/or other countries. **onsemi** owns the rights to a number of patents, trademarks, copyrights, trade secrets, and other intellectual property. A listing of **onsemi**'s product/patent coverage may be accessed at www.onsemi.com/site/pdf/Patent-Marking.pdf. **onsemi** reserves the right to make changes at any time to any products or information herein, without notice. The information herein is provided "as-is" and **onsemi** makes no warranty, representation or guarantee regarding the accuracy of the information, product features, availability, functionality, or suitability of its products for any particular purpose, nor does **onsemi** assume any liability arising out of the application or use of any product or circuit, and specifically disclaims any and all liability, including without limitation special, consequential or incidental damages. Buyer is responsible for its products and applications using **onsemi** products, including compliance with all laws, regulations and safety requirements or standards, regardless of any support or applications information provided by **onsemi**. "Typical" parameters which may be provided in **onsemi** data sheets and/or specifications can and do vary in different applications and actual performance may vary over time. All operating parameters, including "Typicals" must be validated for each customer application by customer's technical experts. **onsemi** does not convey any license under any of its intellectual property rights nor the rights of others. **onsemi** products are not designed, intended, or authorized for use as a critical component in life support systems or any FDA Class 3 medical devices or medical devices with a same or similar classification in a foreign jurisdiction or any devices intended for implantation in the human body. Should Buyer purchase or use **onsemi** products for any such unintended or unauthorized application, Buyer shall indemnify and hold **onsemi** and its officers, employees, subsidiaries, affiliates, and distributors harmless against all claims, costs, damages, and expenses, and reasonable attorney fees arising out of, directly or indirectly, any claim of personal injury or death associated with such unintended or unauthorized use, even if such claim alleges that **onsemi** was negligent regarding the design or manufacture of the part. **onsemi** is an Equal Opportunity/Affirmative Action Employer. This literature is subject to all applicable copyright laws and is not for resale in any manner.

PUBLICATION ORDERING INFORMATION

LITERATURE FULFILLMENT:

Email Requests to: orderlit@onsemi.com

onsemi Website: www.onsemi.com

TECHNICAL SUPPORT

North American Technical Support:

Voice Mail: 1 800-282-9855 Toll Free USA/Canada

Phone: 011 421 33 790 2910

Europe, Middle East and Africa Technical Support:

Phone: 00421 33 790 2910

For additional information, please contact your local Sales Representative

X-ON Electronics

Largest Supplier of Electrical and Electronic Components

Click to view similar products for [Power Switch ICs - Power Distribution](#) *category:*

Click to view products by [ON Semiconductor](#) *manufacturer:*

Other Similar products are found below :

[TCK111G,LF\(S](#) [FPF1018](#) [DS1222](#) [TCK2065G,LF](#) [SZNCP3712ASNT3G](#) [MIC2033-05BYMT-T5](#) [MIC2033-12AYMT-T5](#) [MIC2033-05BYM6-T5](#) [SLG5NT1437VTR](#) [SZNCP3712ASNT1G](#) [DML1008LDS-7](#) [KTS1670EDA-TR](#) [KTS1640QGDV-TR](#) [KTS1641QGDV-TR](#) [NCV459MNWTBG](#) [FPF2260ATMX](#) [U6513A](#) [MIC2012YM-TR](#) [NCP45780IMN24RTWG](#) [MAX14919ATP+](#) [MC33882PEP](#) [TPS2104DBVR](#) [MIC2098-1YMT-TR](#) [MIC94062YMT TR](#) [MP6231DN-LF](#) [MIC2015-1.2YM6 TR](#) [MIC2075-2YM](#) [MIC94068YML-TR](#) [SIP32461DB-T2-GE1](#) [NCP335FCT2G](#) [TCK105G,LF\(S](#) [AP2411S-13](#) [AP2151DSG-13](#) [MIC94094YC6-TR](#) [MIC94093YC6-TR](#) [MIC94064YC6-TR](#) [MIC94061YMT-TR](#) [MIC2505-1YM](#) [MIC94305YMT-TR](#) [MIC94085YFT-TR](#) [MIC94081YFT-TR](#) [MIC94042YFL-TR](#) [MIC94041YFL-TR](#) [MIC2005-1.2YM6-TR](#) [TPS2032QDRQ1](#) [NCP333FCT2G](#) [BTS3050TFATMA1](#) [NCP331SNT1G](#) [TPS2092DR](#) [TPS2063DR](#)