

# HMHA281, HMHA2801 Series

## 4-Pin Half-Pitch Mini-Flat Phototransistor Optocouplers

### Description

The HMHA281 and HMHA2801 series devices consist of a gallium arsenide infrared emitting diode driving a silicon phototransistor in a compact 4-pin mini-flat package. The lead pitch is 1.27 mm.

### Features

- Compact 4-Pin Package
  - ◆ 2.4 mm Maximum Standoff Height
  - ◆ Half-Pitch Leads for Optimum Board Space Savings
- Current Transfer Ratio:
  - ◆ HMHA281: 50% to 600%
  - ◆ HMHA2801: 80% to 600%
  - ◆ HMHA2801A: 80% to 160%
  - ◆ HMHA2801B: 130% to 260%
  - ◆ HMHA2801C: 200% to 400%
- Safety and Regulatory Approvals:
  - ◆ UL1577, 3.750 VAC<sub>RMS</sub> for 1 Minute
  - ◆ DIN-EN/IEC60747-5-5, 565 V Peak Working Insulation Voltage
- These Devices are Pb-Free and are RoHS Compliant

### Applications

- Digital Logic Inputs
- Microprocessor Inputs
- Power Supply Monitor
- Twisted Pair Line Receiver
- Telephone Line Receiver



ON Semiconductor®

[www.onsemi.com](http://www.onsemi.com)

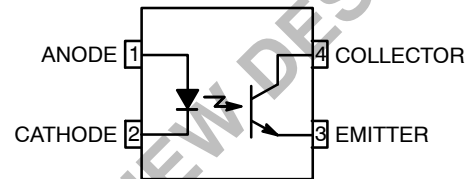

Phototransistor Optocoupler

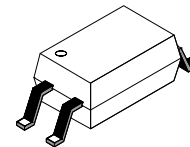

MPF4  
CASE 100AL

### MARKING DIAGRAM

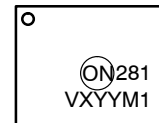

- ON = ON Semiconductor Logo
- 281 = Device Number
- V = DIN EN/IEC60747-5-5 Option (only appears on component ordered with this option)
- X = One-Digit Year Code, e.g., "5"
- YY = Digit Work Week, Ranging from "01" to "53"
- M1 = Assembly Package Code

### ORDERING INFORMATION

See detailed ordering and shipping information on page 7 of this data sheet.

## HMHA281, HMHA2801 Series

**Table 1. SAFETY AND INSULATION RATINGS** (As per DIN EN/IEC 60747-5-5, this optocoupler is suitable for “safe electrical insulation” only within the safety limit data. Compliance with the safety ratings shall be ensured by means of protective circuits.)

| Parameter   |                        | Characteristics |
|---|------------------------|-----------------|
| Installation Classifications per DIN VDE 0110/1.89 Table 1, For Rated Mains Voltage | < 150 V <sub>RMS</sub> | I–IV            |
|   | < 300 V <sub>RMS</sub> | I–III           |
| Climatic Classification   |                        | 55/100/21       |
| Pollution Degree (DIN VDE 0110/1.89)  |                        | 2               |
| Comparative Tracking Index  |                        | 175             |

| Symbol                 | Parameter  | Value            | Unit              |
|------------------------|--|------------------|-------------------|
| V <sub>PR</sub>        | Input-to-Output Test Voltage, Method A, V <sub>IORM</sub> × 1.6 = V <sub>PR</sub> , Type and Sample Test with t <sub>m</sub> = 10 s, Partial Discharge < 5 pC  | 904              | V <sub>peak</sub> |
|                        | Input-to-Output Test Voltage, Method B, V <sub>IORM</sub> × 1.875 = V <sub>PR</sub> , 100% Production Test with t <sub>m</sub> = 1 s, Partial Discharge < 5 pC | 1060             | V <sub>peak</sub> |
| V <sub>IORM</sub>      | Maximum Working Insulation Voltage   | 565              | V <sub>peak</sub> |
| V <sub>IOTM</sub>      | Highest Allowable Over-Voltage   | 4000             | V <sub>peak</sub> |
|                        | External Creepage  | ≥5               | mm                |
|                        | External Clearance   | ≥5               | mm                |
| DTI                    | Distance Through Insulation (Insulation Thickness)   | ≥0.4             | mm                |
| T <sub>S</sub>         | Case Temperature (Note 1)  | 150              | °C                |
| I <sub>S, INPUT</sub>  | Input Current (Note 1)   | 200              | mA                |
| P <sub>S, OUTPUT</sub> | Output Power (Note 1)  | 300              | mW                |
| R <sub>IO</sub>        | Insulation Resistance at T <sub>S</sub> , V <sub>IO</sub> = 500 V (Note 1)   | >10 <sup>9</sup> | Ω                 |

1. Safety limit values – maximum values allowed in the event of a failure.

## HMHA281, HMHA2801 Series

### ABSOLUTE MAXIMUM RATINGS (T<sub>C</sub> = 25°C, Unless otherwise specified)

| Symbol | Parameter | Value | Unit |
|--------|-----------|-------|------|
|--------|-----------|-------|------|

#### TOTAL PACKAGE

|                  |  |             |       |
|------------------|--|-------------|-------|
| T <sub>STG</sub> | Storage Temperature                                    | -55 to +125 | °C    |
| T <sub>OPR</sub> | Operating Temperature                                  | -55 to +100 | °C    |
| T <sub>J</sub>   | Junction Temperature                                   | -40 to +125 | °C    |
| P <sub>D</sub>   | Total Device Power Dissipation @ T <sub>A</sub> = 25°C | 210         | mW    |
|                  | Derate Above 25°C                                      | 2.1         | mW/°C |

#### EMITTER

|                      |   |     |       |
|----------------------|---|-----|-------|
| I <sub>F (avg)</sub> | Continuous Forward Current                    | 50  | mA    |
| I <sub>F (pk)</sub>  | Peak Forward Current (1 μs pulse, 300 pps)    | 1   | A     |
| V <sub>R</sub>       | Reverse Input Voltage                         | 6   | V     |
| P <sub>D</sub>       | LED Power Dissipation @ T <sub>A</sub> = 25°C | 60  | mW    |
|                      | Derate Above 25°C                             | 0.6 | mW/°C |

#### DETECTOR

|                  |  |     |       |
|------------------|--|-----|-------|
| I <sub>C</sub>   | Continuous Collector Current                       | 50  | mA    |
| V <sub>CEO</sub> | Collector-Emitter Voltage                          | 80  | V     |
| V <sub>ECO</sub> | Emitter-Collector Voltage                          | 7   | V     |
| P <sub>D</sub>   | Detector Power Dissipation @ T <sub>A</sub> = 25°C | 150 | mW    |
|                  | Derate Above 25°C                                  | 1.5 | mW/°C |

Stresses exceeding those listed in the Maximum Ratings table may damage the device. If any of these limits are exceeded, device functionality should not be assumed, damage may occur and reliability may be affected.

## HMHA281, HMHA2801 Series

### ELECTRICAL CHARACTERISTICS (T<sub>A</sub> = 25°C)

| Symbol | Parameter | Test Conditions | Device | Min | Typ | Max | Unit |
|--------|-----------|-----------------|--------|-----|-----|-----|------|
|--------|-----------|-----------------|--------|-----|-----|-----|------|

#### INDIVIDUAL COMPONENT CHARACTERISTICS

##### Emitter

|                |                 |                        |     |     |   |     |    |
|----------------|-----------------|------------------------|-----|-----|---|-----|----|
| V <sub>F</sub> | Forward Voltage | I <sub>F</sub> = 10 mA | All | 1.0 | – | 1.3 | V  |
| I <sub>R</sub> | Reverse Current | V <sub>R</sub> = 5 V   | All | –   | – | 5   | μA |

##### Detector

|                   |  |   |     |    |    |     |    |
|-------------------|--|---|-----|----|----|-----|----|
| BV <sub>CEO</sub> | Breakdown Voltage Collector to Emitter | I <sub>C</sub> = 0.5 mA, I <sub>F</sub> = 0 | All | 80 | –  | –   | V  |
| BV <sub>ECO</sub> | Emitter to Collector                   | I <sub>E</sub> = 100 μA, I <sub>F</sub> = 0 | All | 7  | –  | –   |    |
| I <sub>CEO</sub>  | Collector Dark Current                 | V <sub>CE</sub> = 80 V, I <sub>F</sub> = 0  | All | –  | –  | 100 | nA |
| C <sub>CE</sub>   | Capacitance                            | V <sub>CE</sub> = 0 V, f = 1 MHz            | All | –  | 10 | –   | pF |

#### TRANSFER CHARACTERISTICS

|                       |                           |  |  |     |   |     |    |
|-----------------------|---------------------------|--|--|-----|---|-----|----|
| CTR                   | DC Current Transfer Ratio | I <sub>F</sub> = 5 mA, V <sub>CE</sub> = 5 V                         | HMHA281  | 50  | – | 600 | %  |
|                       |                           |  | HMHA2801   | 80  | – | 600 |    |
|                       |                           |  | HMHA2801A  | 80  | – | 160 |    |
|                       |                           |  | HMHA2801B  | 130 | – | 260 |    |
|                       |                           |  | HMHA2801C  | 200 | – | 400 |    |
| V <sub>CE (SAT)</sub> | Saturation Voltage        | I <sub>F</sub> = 8 mA, I <sub>C</sub> = 2.4 mA                       | HMHA281  | –   | – | 0.4 | V  |
|                       |                           | I <sub>F</sub> = 10 mA, I <sub>C</sub> = 2 mA                        | HMHA2801,<br>HMHA2801A,<br>HMHA2801B,<br>HMHA2801C | –   | – | 0.3 |    |
| t <sub>r</sub>        | Rise Time (Non-Saturated) | I <sub>C</sub> = 2 mA, V <sub>CE</sub> = 5 V, R <sub>L</sub> = 100 Ω | All  | –   | 3 | –   | μs |
| t <sub>f</sub>        | Fall Time (Non-Saturated) | I <sub>C</sub> = 2 mA, V <sub>CE</sub> = 5 V, R <sub>L</sub> = 100 Ω | All  | –   | 3 | –   |    |

#### ISOLATION CHARACTERISTICS

|                  |                                |          |     |      |   |   |                    |
|------------------|--------------------------------|----------|-----|------|---|---|--------------------|
| V <sub>ISO</sub> | Steady State Isolation Voltage | 1 Minute | All | 3750 | – | – | VAC <sub>RMS</sub> |
|------------------|--------------------------------|----------|-----|------|---|---|--------------------|

Product parametric performance is indicated in the Electrical Characteristics for the listed test conditions, unless otherwise noted. Product performance may not be indicated by the Electrical Characteristics if operated under different conditions.

# HMHA281, HMHA2801 Series

## TYPICAL PERFORMANCE CHARACTERISTICS

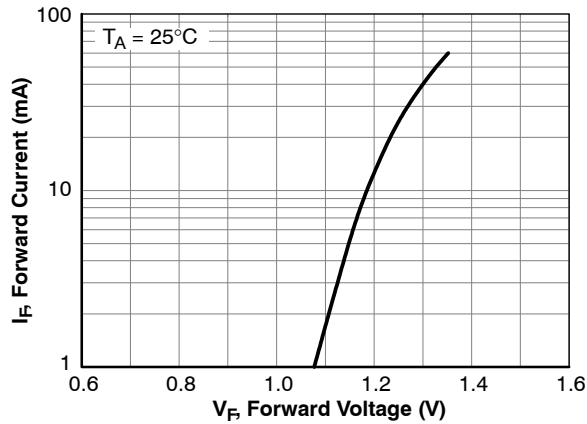

Figure 1. Forward Current vs. Forward Voltage

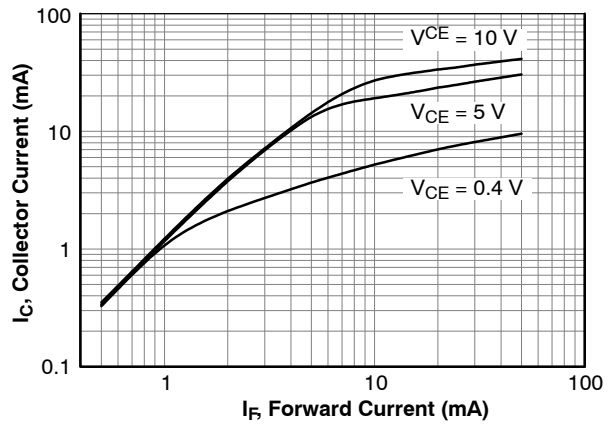

Figure 2. Collector Current vs. Forward Current

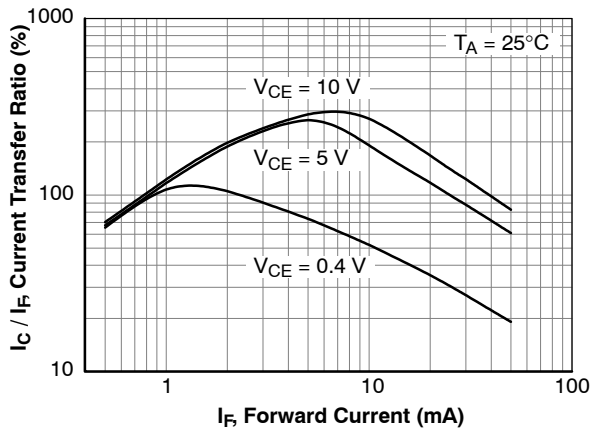

Figure 3. Current Transfer Ratio vs. Forward Current

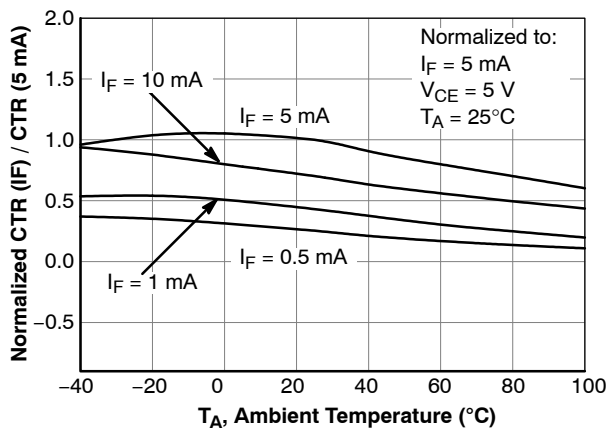

Figure 4. Normalized CTR vs. Temperature

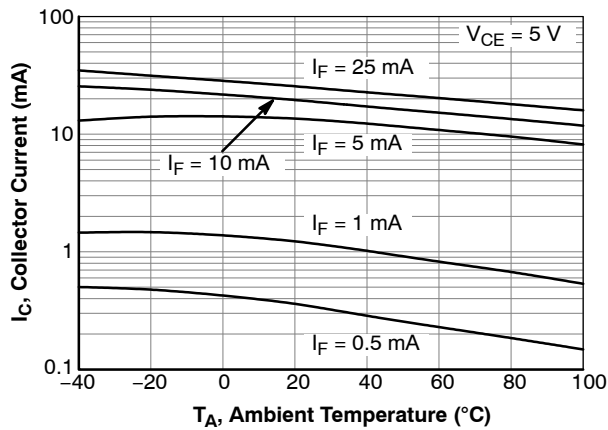

Figure 5. Collector Current vs. Temperature

# HMHA281, HMHA2801 Series

## TYPICAL PERFORMANCE CHARACTERISTICS (Continued)

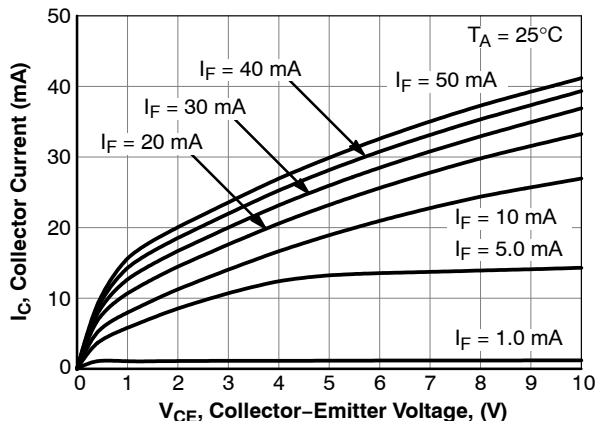

Figure 6. Collector Current vs. Collector-Emitter Voltage

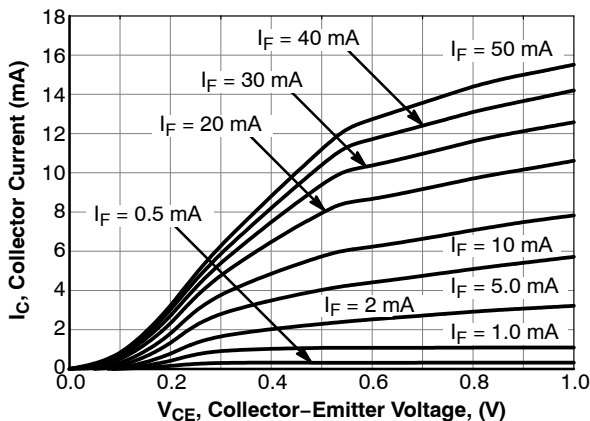

Figure 7. Collector Current vs. Collector-Emitter Voltage

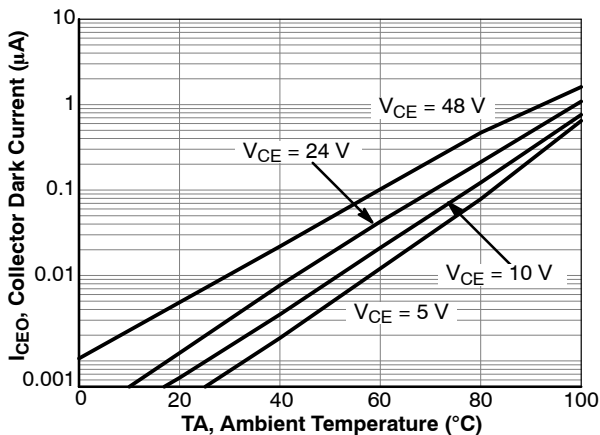

Figure 8. Collector Dark Current vs. Temperature

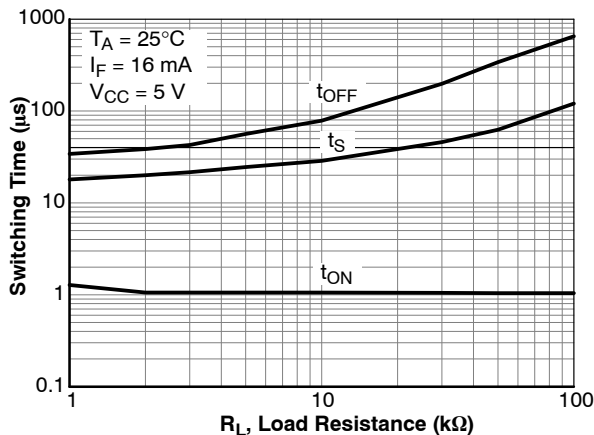

Figure 9. Switching Time vs. Load Resistance

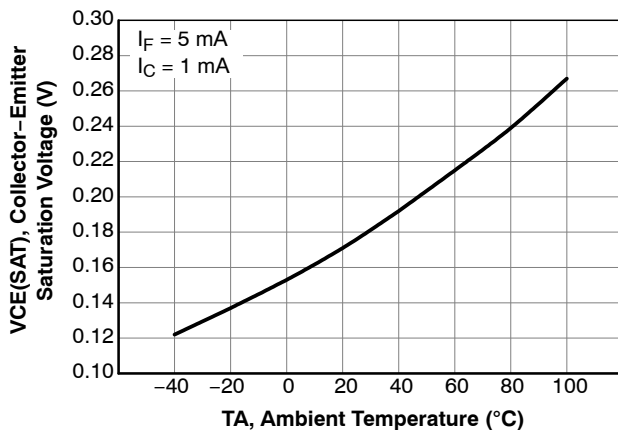

Figure 10. Collector-Emitter Saturation Voltage vs Temperature

# HMHA281, HMHA2801 Series

## REFLOW PROFILE

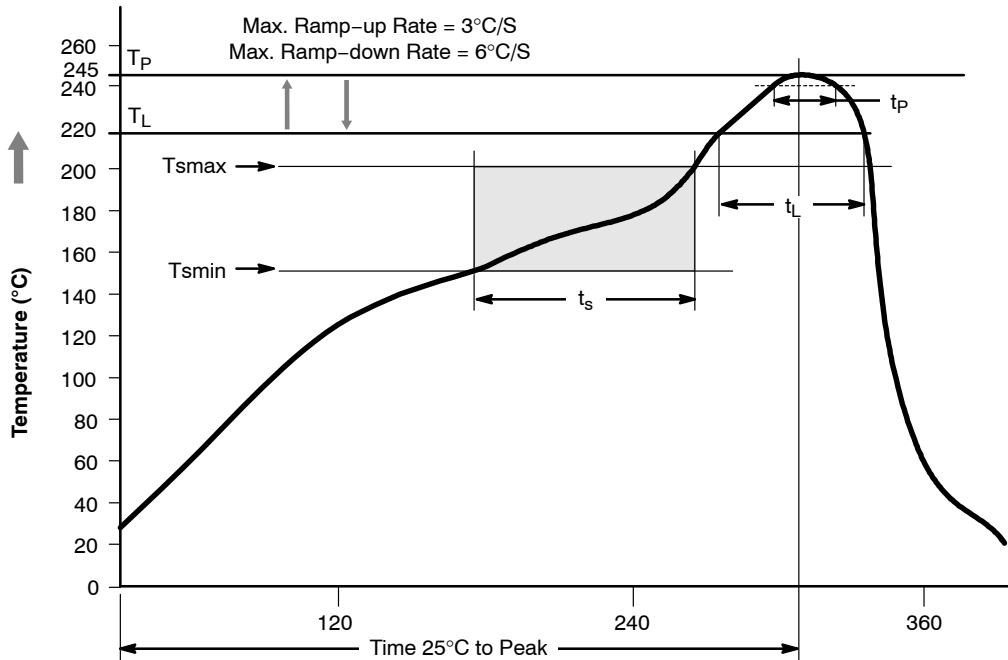

Figure 11. Reflow Profile

| Profile Feature                                  | Pb-Free Assembly Profile |
|--|--------------------------|
| Temperature Minimum ( $T_{smin}$ )               | 150°C                    |
| Temperature Maximum ( $T_{smax}$ )               | 200°C                    |
| Time ( $t_s$ ) from ( $T_{smin}$ to $T_{smax}$ ) | 60 – 120 seconds         |
| Ramp-up Rate ( $t_L$ to $t_P$ )                  | 3°C / second maximum     |
| Liquidous Temperature ( $T_L$ )                  | 217°C                    |
| Time ( $t_L$ ) Maintained Above ( $T_L$ )        | 60 – 150 seconds         |
| Peak Body Package Temperature                    | 245°C +0°C / -5°C        |
| Time ( $t_P$ ) within 5°C of 245°C               | 30 seconds               |
| Ramp-down Rate ( $T_P$ to $T_L$ )                | 6°C / second maximum     |
| Time 25°C to Peak Temperature                    | 8 minutes maximum        |

### ORDERING INFORMATION

| Part Number | Package  | Shipping†          |
|-------------|--|--------------------|
| HMHA2801    | Half Pitch Mini-Flat 4-Pin                             | 100 Units / Tube   |
| HMHA2801R2  | Half Pitch Mini-Flat 4-Pin                             | 2500 / Tape & Reel |
| HMHA2801V   | Half Pitch Mini-Flat 4-Pin, DIN EN/IEC60747-5-5 Option | 100 Units / Tube   |
| HMHA2801R2V | Half Pitch Mini-Flat 4-Pin, DIN EN/IEC60747-5-5 Option | 2500 / Tape & Reel |

†For information on tape and reel specifications, including part orientation and tape sizes, please refer to our Tape and Reel Packaging Specifications Brochure, BRD8011/D.

**MECHANICAL CASE OUTLINE**  
**PACKAGE DIMENSIONS**

MFP4 2.5X4.4, 1.27P  
CASE 100AL  
ISSUE O

DATE 31 AUG 2016

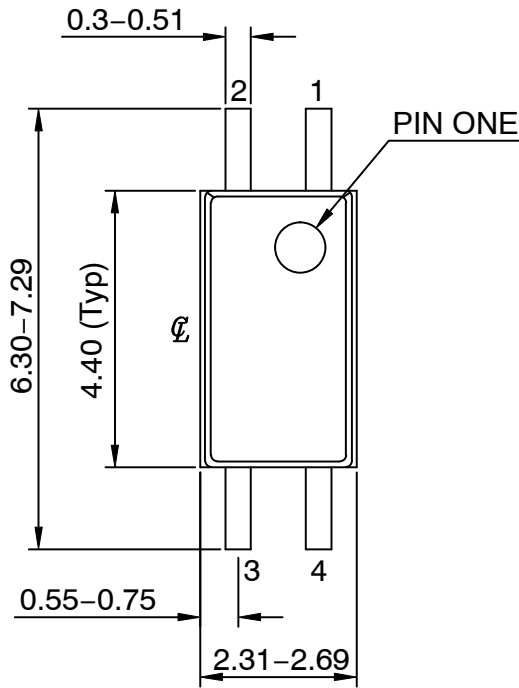

**LAND PATTERN RECOMMENDATION**

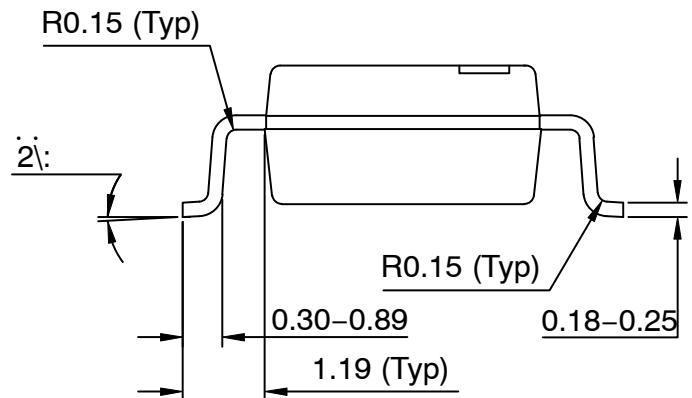
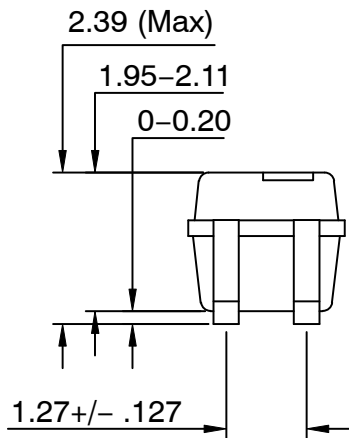

**NOTES:**

- A) NO STANDARD APPLIES TO THIS PACKAGE
- B) ALL DIMENSIONS ARE IN MILLIMETERS.
- C) DIMENSIONS ARE EXCLUSIVE OF BURRS, MOLD FLASH, AND TIE BAR EXTRUSION

|                         |                            |  |
|-------------------------|----------------------------|--|
| <b>DOCUMENT NUMBER:</b> | <b>98AON13485G</b>         | Electronic versions are uncontrolled except when accessed directly from the Document Repository. Printed versions are uncontrolled except when stamped "CONTROLLED COPY" in red. |
| <b>DESCRIPTION:</b>     | <b>MFP4 2.5X4.4, 1.27P</b> | <b>PAGE 1 OF 1</b>   |

ON Semiconductor and **ON** are trademarks of Semiconductor Components Industries, LLC dba ON Semiconductor or its subsidiaries in the United States and/or other countries. ON Semiconductor reserves the right to make changes without further notice to any products herein. ON Semiconductor makes no warranty, representation or guarantee regarding the suitability of its products for any particular purpose, nor does ON Semiconductor assume any liability arising out of the application or use of any product or circuit, and specifically disclaims any and all liability, including without limitation special, consequential or incidental damages. ON Semiconductor does not convey any license under its patent rights nor the rights of others.



**onsemi**, **Onsemi**, and other names, marks, and brands are registered and/or common law trademarks of Semiconductor Components Industries, LLC dba "**onsemi**" or its affiliates and/or subsidiaries in the United States and/or other countries. **onsemi** owns the rights to a number of patents, trademarks, copyrights, trade secrets, and other intellectual property. A listing of **onsemi**'s product/patent coverage may be accessed at [www.onsemi.com/site/pdf/Patent-Marking.pdf](http://www.onsemi.com/site/pdf/Patent-Marking.pdf). **onsemi** reserves the right to make changes at any time to any products or information herein, without notice. The information herein is provided "as-is" and **onsemi** makes no warranty, representation or guarantee regarding the accuracy of the information, product features, availability, functionality, or suitability of its products for any particular purpose, nor does **onsemi** assume any liability arising out of the application or use of any product or circuit, and specifically disclaims any and all liability, including without limitation special, consequential or incidental damages. Buyer is responsible for its products and applications using **onsemi** products, including compliance with all laws, regulations and safety requirements or standards, regardless of any support or applications information provided by **onsemi**. "Typical" parameters which may be provided in **onsemi** data sheets and/or specifications can and do vary in different applications and actual performance may vary over time. All operating parameters, including "Typicals" must be validated for each customer application by customer's technical experts. **onsemi** does not convey any license under any of its intellectual property rights nor the rights of others. **onsemi** products are not designed, intended, or authorized for use as a critical component in life support systems or any FDA Class 3 medical devices or medical devices with a same or similar classification in a foreign jurisdiction or any devices intended for implantation in the human body. Should Buyer purchase or use **onsemi** products for any such unintended or unauthorized application, Buyer shall indemnify and hold **onsemi** and its officers, employees, subsidiaries, affiliates, and distributors harmless against all claims, costs, damages, and expenses, and reasonable attorney fees arising out of, directly or indirectly, any claim of personal injury or death associated with such unintended or unauthorized use, even if such claim alleges that **onsemi** was negligent regarding the design or manufacture of the part. **onsemi** is an Equal Opportunity/Affirmative Action Employer. This literature is subject to all applicable copyright laws and is not for resale in any manner.

## PUBLICATION ORDERING INFORMATION

### LITERATURE FULFILLMENT:

Email Requests to: [orderlit@onsemi.com](mailto:orderlit@onsemi.com)

**onsemi Website:** [www.onsemi.com](http://www.onsemi.com)

### TECHNICAL SUPPORT

**North American Technical Support:**

Voice Mail: 1 800-282-9855 Toll Free USA/Canada

Phone: 011 421 33 790 2910

**Europe, Middle East and Africa Technical Support:**

Phone: 00421 33 790 2910

For additional information, please contact your local Sales Representative

## X-ON Electronics

Largest Supplier of Electrical and Electronic Components

*Click to view similar products for [Transistor Output Optocouplers](#) category:*

*Click to view products by [ON Semiconductor](#) manufacturer:*

Other Similar products are found below :

[LTV-814S-TA](#) [LTV-824HS](#) [66095-001](#) [6N136-X017T](#) [MCT6-X007](#) [MOC8101-X017T](#) [PS2561A-1-W-A](#) [PS2561B-1-L-A](#) [PS2561L-1-V-A](#)  
[MRF658](#) [IL755-1X007](#) [ILD2-X006](#) [ILD74-X001](#) [ILQ615-2X017](#) [ILQ615-3X016](#) [LDA102S](#) [LDA110S](#) [SFH615AGR-X007T](#) [PS2561-1-V-](#)  
[W-A](#) [PS2561AL-1-V-A](#) [PS2561L1-1-L-A](#) [PS2581L2-A](#) [PS2701A-1-F3-P-A](#) [PS2801-1-F3-P-A](#) [PS2911-1-L-AX](#) [CNY17-2X017](#) [CNY17-](#)  
[4X001](#) [CNY17-4X017](#) [CNY17F-1X007](#) [CNY17F-2X017](#) [CNY17F-4X001](#) [CNY17G-1](#) [LTV-214](#) [LTV-702VB](#) [LTV-733S](#) [LTV-816S-TA](#)  
[LTV-825S](#) [TCET1113](#) [TCET2100](#) [4N25-X007T](#) [IL215AT](#) [ILD615-1X007](#) [ILQ2-X007](#) [VOS615A-2T](#) [WPPC-A11066AA](#) [WPPC-](#)  
[A11066AD](#) [WPPC-A11084ASS](#) [WPPC-A21068AA](#) [WPPC-D11066AA](#) [WPPC-D21068ED](#)