

ON Semiconductor

Is Now

onsemi™

To learn more about onsemi™, please visit our website at
www.onsemi.com

onsemi and **onsemi** and other names, marks, and brands are registered and/or common law trademarks of Semiconductor Components Industries, LLC dba "**onsemi**" or its affiliates and/or subsidiaries in the United States and/or other countries. **onsemi** owns the rights to a number of patents, trademarks, copyrights, trade secrets, and other intellectual property. A listing of **onsemi** product/patent coverage may be accessed at www.onsemi.com/site/pdf/Patent-Marking.pdf. **onsemi** reserves the right to make changes at any time to any products or information herein, without notice. The information herein is provided "as-is" and **onsemi** makes no warranty, representation or guarantee regarding the accuracy of the information, product features, availability, functionality, or suitability of its products for any particular purpose, nor does **onsemi** assume any liability arising out of the application or use of any product or circuit, and specifically disclaims any and all liability, including without limitation special, consequential or incidental damages. Buyer is responsible for its products and applications using **onsemi** products, including compliance with all laws, regulations and safety requirements or standards, regardless of any support or applications information provided by **onsemi**. "Typical" parameters which may be provided in **onsemi** data sheets and/or specifications can and do vary in different applications and actual performance may vary over time. All operating parameters, including "Typicals" must be validated for each customer application by customer's technical experts. **onsemi** does not convey any license under any of its intellectual property rights nor the rights of others. **onsemi** products are not designed, intended, or authorized for use as a critical component in life support systems or any FDA Class 3 medical devices or medical devices with a same or similar classification in a foreign jurisdiction or any devices intended for implantation in the human body. Should Buyer purchase or use **onsemi** products for any such unintended or unauthorized application, Buyer shall indemnify and hold **onsemi** and its officers, employees, subsidiaries, affiliates, and distributors harmless against all claims, costs, damages, and expenses, and reasonable attorney fees arising out of, directly or indirectly, any claim of personal injury or death associated with such unintended or unauthorized use, even if such claim alleges that **onsemi** was negligent regarding the design or manufacture of the part. **onsemi** is an Equal Opportunity/Affirmative Action Employer. This literature is subject to all applicable copyright laws and is not for resale in any manner. Other names and brands may be claimed as the property of others.



Is Now Part of



ON Semiconductor®

To learn more about ON Semiconductor, please visit our website at
www.onsemi.com

Please note: As part of the Fairchild Semiconductor integration, some of the Fairchild orderable part numbers will need to change in order to meet ON Semiconductor's system requirements. Since the ON Semiconductor product management systems do not have the ability to manage part nomenclature that utilizes an underscore (_), the underscore (_) in the Fairchild part numbers will be changed to a dash (-). This document may contain device numbers with an underscore (_). Please check the ON Semiconductor website to verify the updated device numbers. The most current and up-to-date ordering information can be found at www.onsemi.com. Please email any questions regarding the system integration to Fairchild_questions@onsemi.com.

ON Semiconductor and the ON Semiconductor logo are trademarks of Semiconductor Components Industries, LLC dba ON Semiconductor or its subsidiaries in the United States and/or other countries. ON Semiconductor owns the rights to a number of patents, trademarks, copyrights, trade secrets, and other intellectual property. A listing of ON Semiconductor's product/patent coverage may be accessed at www.onsemi.com/site/pdf/Patent-Marking.pdf. ON Semiconductor reserves the right to make changes without further notice to any products herein. ON Semiconductor makes no warranty, representation or guarantee regarding the suitability of its products for any particular purpose, nor does ON Semiconductor assume any liability arising out of the application or use of any product or circuit, and specifically disclaims any and all liability, including without limitation special, consequential or incidental damages. Buyer is responsible for its products and applications using ON Semiconductor products, including compliance with all laws, regulations and safety requirements or standards, regardless of any support or applications information provided by ON Semiconductor. "Typical" parameters which may be provided in ON Semiconductor data sheets and/or specifications can and do vary in different applications and actual performance may vary over time. All operating parameters, including "Typicals" must be validated for each customer application by customer's technical experts. ON Semiconductor does not convey any license under its patent rights nor the rights of others. ON Semiconductor products are not designed, intended, or authorized for use as a critical component in life support systems or any FDA Class 3 medical devices or medical devices with a same or similar classification in a foreign jurisdiction or any devices intended for implantation in the human body. Should Buyer purchase or use ON Semiconductor products for any such unintended or unauthorized application, Buyer shall indemnify and hold ON Semiconductor and its officers, employees, subsidiaries, affiliates, and distributors harmless against all claims, costs, damages, and expenses, and reasonable attorney fees arising out of, directly or indirectly, any claim of personal injury or death associated with such unintended or unauthorized use, even if such claim alleges that ON Semiconductor was negligent regarding the design or manufacture of the part. ON Semiconductor is an Equal Opportunity/Affirmative Action Employer. This literature is subject to all applicable copyright laws and is not for resale in any manner.

HMHAA280

AC Input, Half Pitch Mini-Flat Package 4-Pin Optocoupler

Features

- Compact 4-pin package (2.4mm maximum standoff height)
- Half pitch leads for optimum board space savings
- Current Transfer Ratio: 50–600%
- Available in tape and reel quantities of 2500
- CSA (File #1201524), UL (File #E90700) and VDE (File #136480) certified

Applications

- AC line monitor
- Unknown polarity DC sensor
- Telephone line receiver

Description

The HMHAA280 series consists of two gallium arsenide infrared emitting diodes, connected in inverse parallel, driving a single silicon phototransistor in a compact 4-pin mini-flat package. The lead pitch is 1.27mm.

Package Dimensions

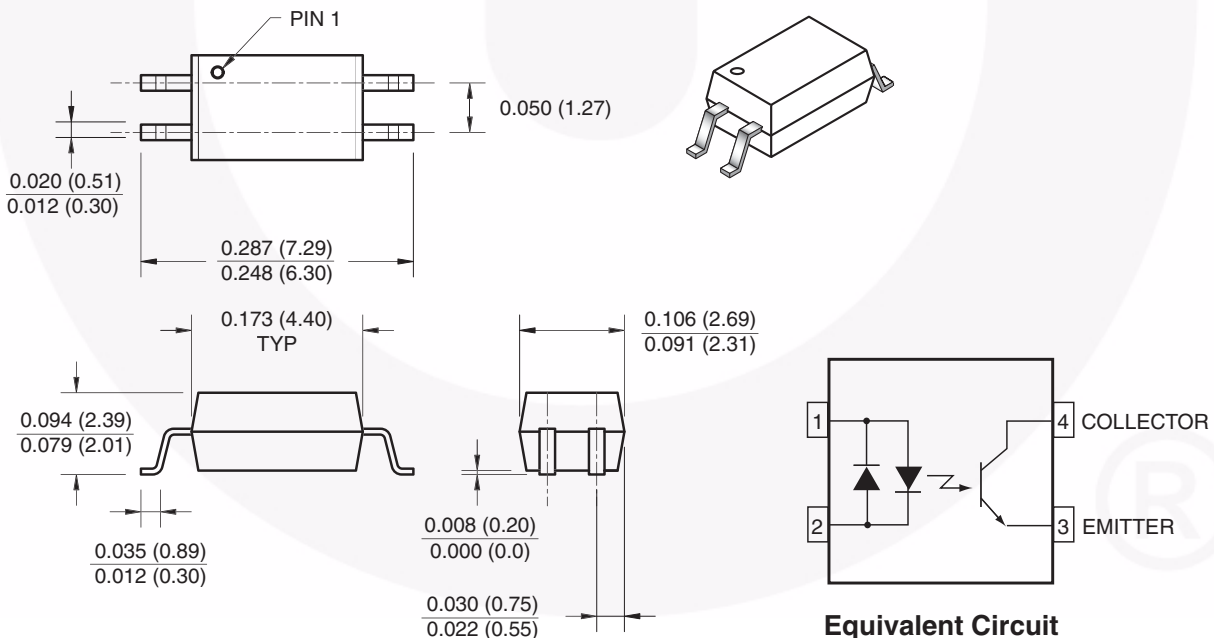

Note:

All dimensions are in inches (millimeters)

Absolute Maximum Ratings ($T_A = 25^\circ\text{C}$ unless otherwise specified)

Stresses exceeding the absolute maximum ratings may damage the device. The device may not function or be operable above the recommended operating conditions and stressing the parts to these levels is not recommended. In addition, extended exposure to stresses above the recommended operating conditions may affect device reliability. The absolute maximum ratings are stress ratings only.

Symbol	Parameter	Value	Units
TOTAL PACKAGE			
T_{STG}	Storage Temperature	-55 to +125	$^\circ\text{C}$
T_{OPR}	Operating Temperature	-55 to +100	$^\circ\text{C}$
EMITTER			
$I_{\text{F (avg)}}$	Continuous Forward Current	50	mA
$I_{\text{F (pk)}}$	Peak Forward Current (1 μs pulse, 300pps.)	1	A
V_{R}	Reverse Input Voltage	6	V
P_{D}	Power Dissipation	60	mW
	Derate linearly (above 25°C)	0.6	mW/ $^\circ\text{C}$
DETECTOR			
	Continuous Collector Current	50	mA
P_{D}	Power Dissipation	150	mW
	Derate linearly (above 25°C)	1.5	mW/ $^\circ\text{C}$
V_{CEO}	Collector-Emitter Voltage	80	V
V_{ECO}	Emitter-Collector Voltage	7	V

Electrical Characteristics ($T_A = 25^\circ\text{C}$)

Symbol	Parameter	Test Conditions	Min.	Typ.*	Max.	Unit
INDIVIDUAL COMPONENT CHARACTERISTICS						
Emitter						
V_F	Forward Voltage	$I_F = \pm 5\text{mA}$			1.4	V
I_R	Reverse Current	$V_R = 5\text{V}$			5	μA
Detector						
BV_{CEO}	Breakdown Voltage Collector to Emitter	$I_C = 0.5\text{mA}, I_F = 0$	80			V
BV_{ECO}	Emitter to Collector	$I_E = 100\mu\text{A}, I_F = 0$	7			
I_{CEO}	Collector Dark Current	$V_{CE} = 80\text{V}, I_F = 0$			100	nA
C_{CE}	Capacitance	$V_{CE} = 0\text{V}, f = 1\text{MHz}$		10		pF
TRANSFER CHARACTERISTICS						
CTR	DC Current Transfer Ratio	$I_F = \pm 5\text{mA}, V_{CE} = 5\text{V}$	50		600	%
	CTR Symmetry	$I_F = \pm 5\text{mA}, V_{CE} = 5\text{V}$	0.33		3.0	
$V_{CE(SAT)}$	Saturation Voltage	$I_F = \pm 8\text{mA}, I_C = 2.4\text{mA}$			0.4	V
t_r	Rise Time (Non-Saturated)	$I_C = 2\text{mA}, V_{CE} = 5\text{V}, R_L = 100\Omega$		3		μs
t_f	Fall Time (Non-Saturated)	$I_C = 2\text{mA}, V_{CE} = 5\text{V}, R_L = 100\Omega$		3		
ISOLATION CHARACTERISTICS						
V_{ISO}	Steady State Isolation Voltage	1 Minute	3750			VRMS

*All typicals at $T_A = 25^\circ\text{C}$

Typical Performance Characteristics

Fig. 1 Forward Current vs. Forward Voltage

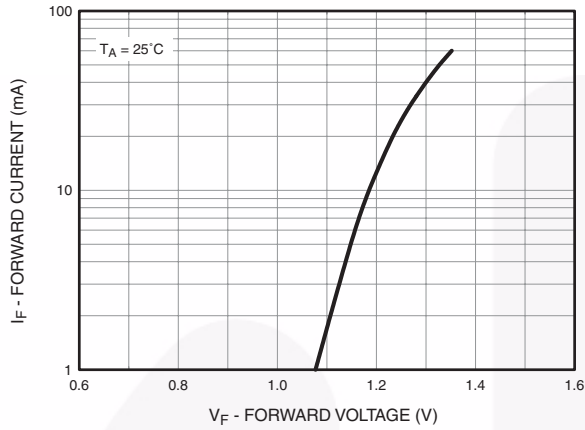

Fig. 2 Collector Current vs. Forward Current

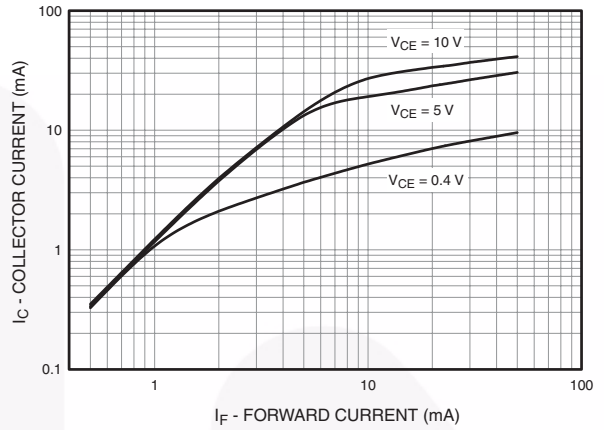

Fig. 3 Current Transfer Ratio vs. Forward Current

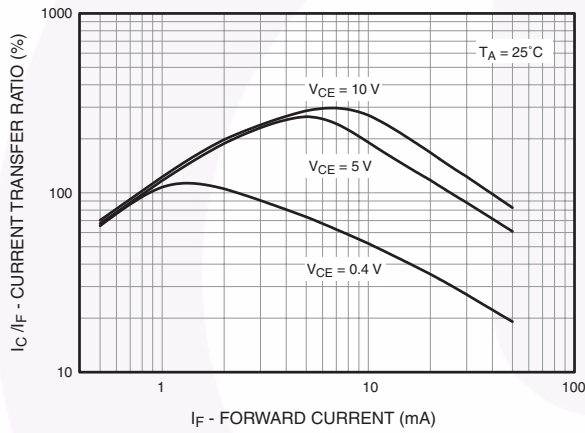

Fig. 4 Normalized CTR vs. Temperature

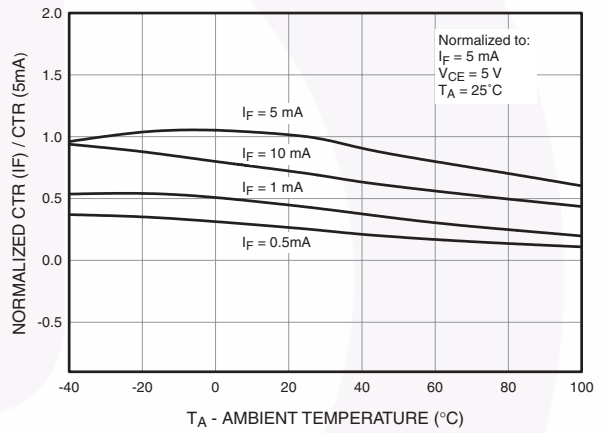
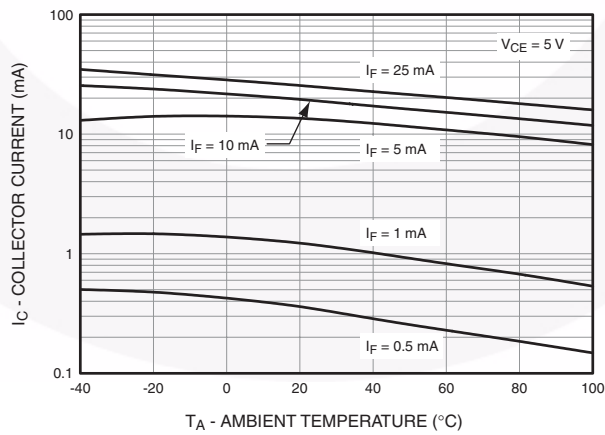

Fig. 5 Collector Current vs. Temperature



Typical Performance Characteristics (Continued)

Fig. 6 Collector Current vs. Collector-Emitter Voltage

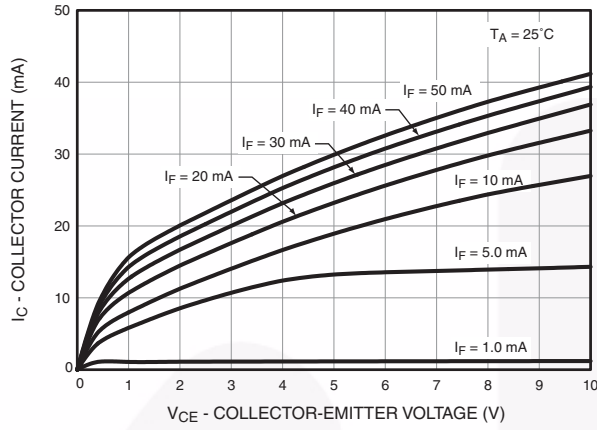

Fig. 7 Collector Current vs. Collector-Emitter Voltage

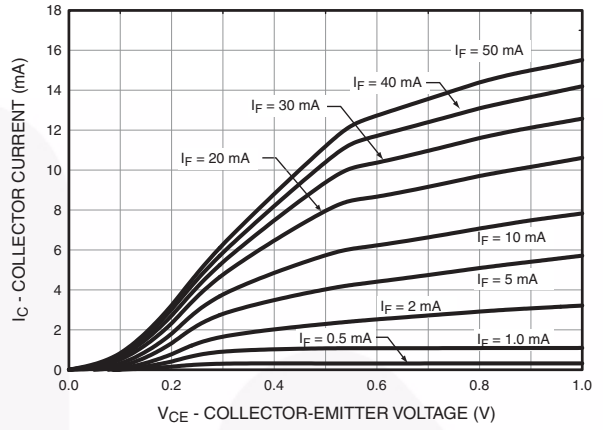

Fig. 8 Collector Dark Current vs. Temperature

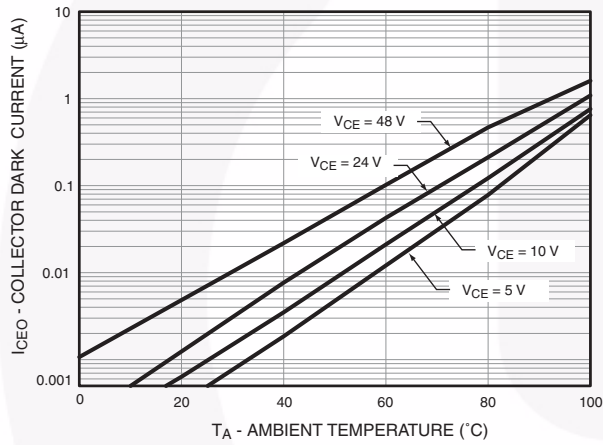

Fig. 9 Switching Time vs. Load Resistance

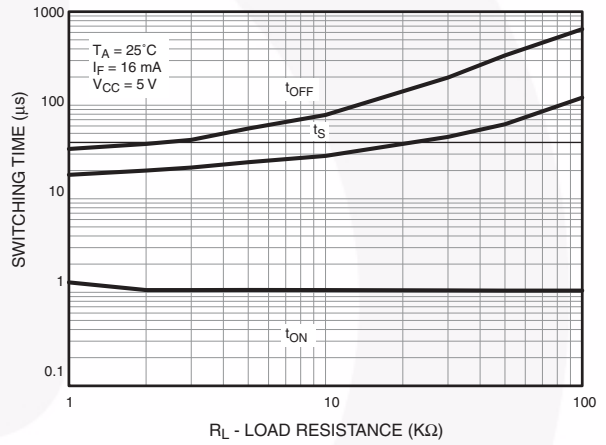
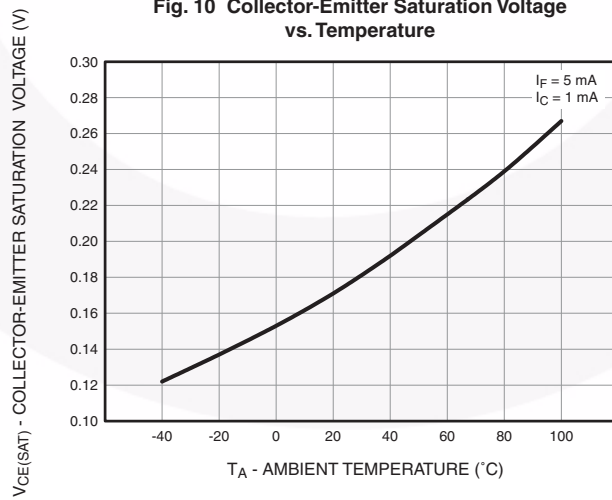

Fig. 10 Collector-Emitter Saturation Voltage vs. Temperature



Ordering Information

Option	Description
V	VDE Approved
R2	Tape and Reel (2500 units)
R2V	Tape and Reel (2500 units) and VDE Approved

Marking Information

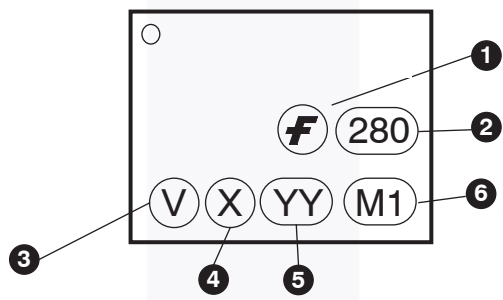

Definitions	
1	Fairchild logo
2	Device number
3	VDE mark (Note: Only appears on parts ordered with VDE option – See order entry table)
4	One digit year code
5	Two digit work week ranging from '01' to '53'
6	Assembly package code

Tape and Reel Dimensions

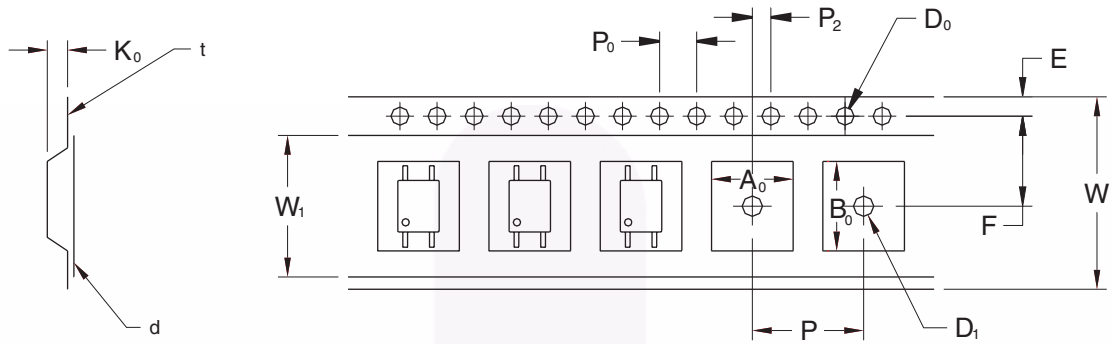

		1.27 Pitch
Description	Symbol	Dimensions (mm)
Tape Width	W	12.00 +0.30/-0.10
Tape Thickness	t	0.30 ±0.05
Sprocket Hole Pitch	P ₀	4.00 ±0.10
Sprocket Hole Diameter	D ₀	1.50 +0.10/-0.0
Sprocket Hole Location	E	1.75 ±0.10
Pocket Location	F	5.50 ±0.10
	P ₂	2.00 ±0.10
Pocket Pitch	P	8.00 ±0.10
Pocket Dimension	A ₀	2.80 ±0.10
	B ₀	7.30 ±0.10
	K ₀	2.30 ±0.10
Pocket Hole Diameter	D ₁	1.50 Min.
Cover Tape Width	W ₁	9.20
Cover Tape Thickness	d	0.065 ±0.010
Max. Component Rotation or Tilt		10° Max.
Devices Per Reel		2500
Reel Diameter		330mm (13")

Footprint Drawing for PCB Layout

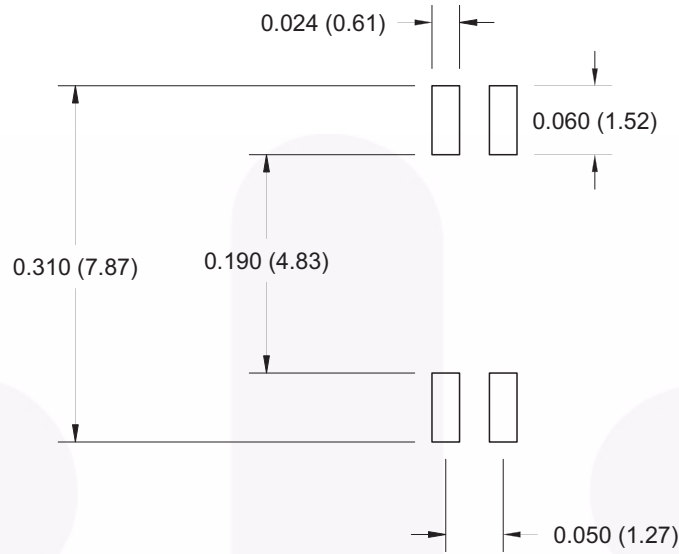

Reflow Profile0

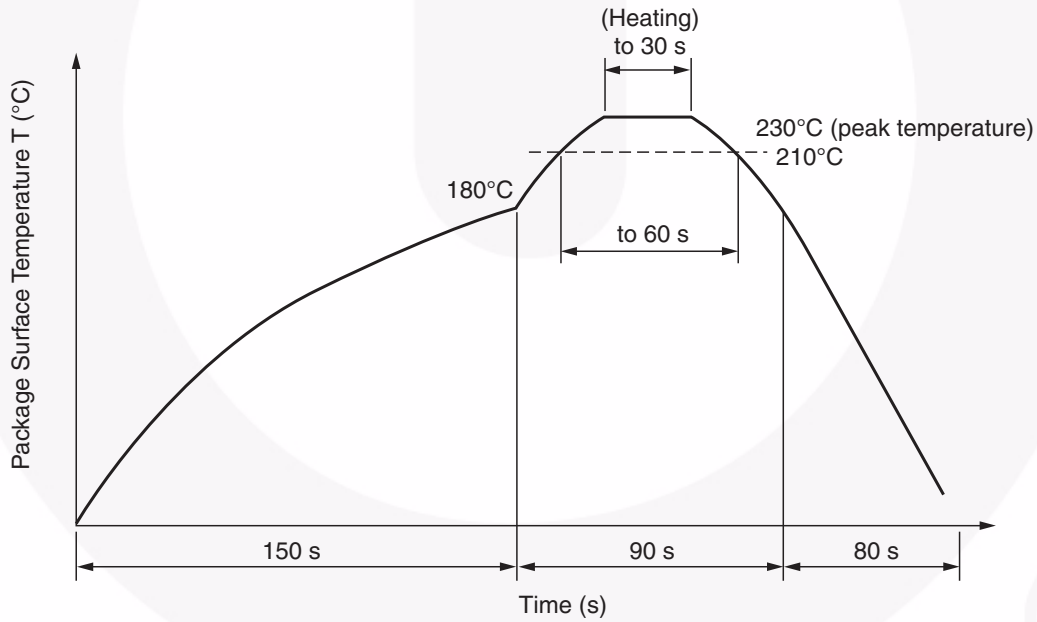

- Peak reflow temperature: 230°C (package surface temperature) for 30 seconds
- Time of temperature higher than 210°C: 60 seconds or less
- One time soldering reflow is recommended

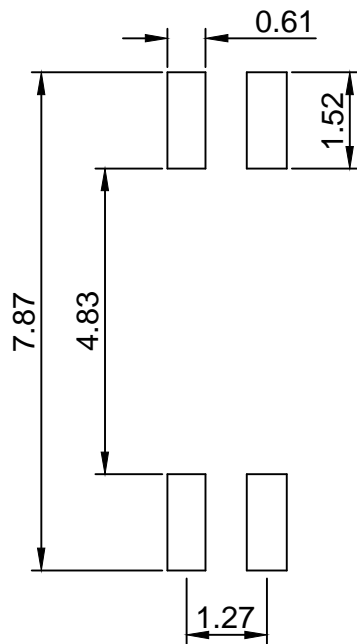
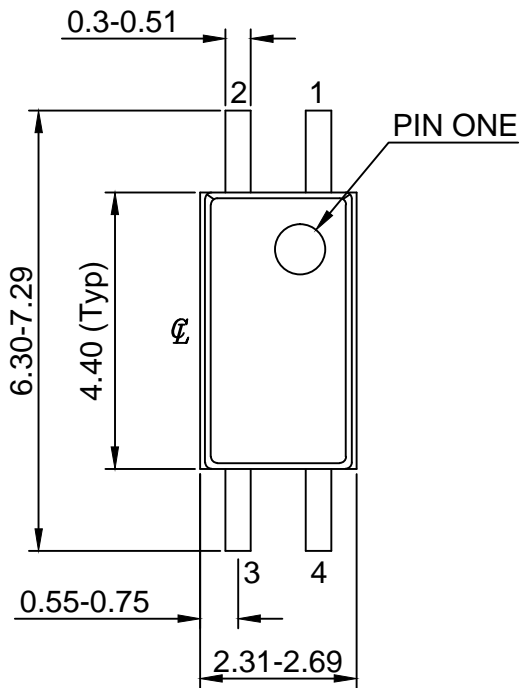

LAND PATTERN RECOMMENDATION

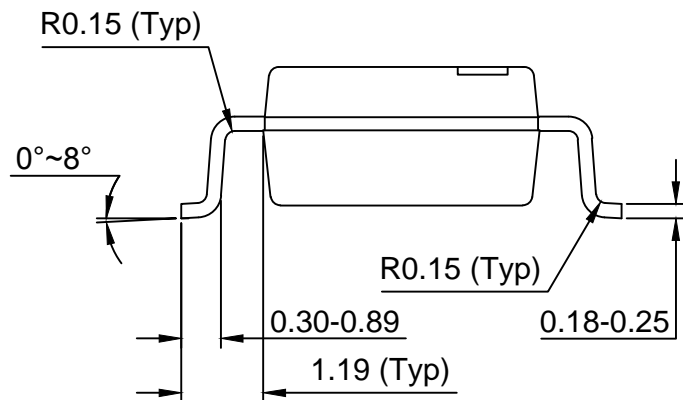
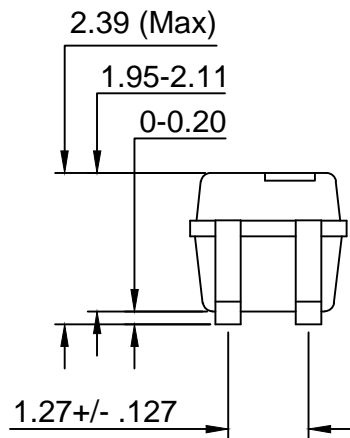

NOTES:

- A) NO STANDARD APPLIES TO THIS PACKAGE
- B) ALL DIMENSIONS ARE IN MILLIMETERS.
- C) DIMENSIONS ARE EXCLUSIVE OF BURRS, MOLD FLASH, AND TIE BAR EXTRUSION
- D) DRAWING FILENAME AND REVISION : MKT-MFP04AREV4.



ON Semiconductor and  are trademarks of Semiconductor Components Industries, LLC dba ON Semiconductor or its subsidiaries in the United States and/or other countries. ON Semiconductor owns the rights to a number of patents, trademarks, copyrights, trade secrets, and other intellectual property. A listing of ON Semiconductor's product/patent coverage may be accessed at www.onsemi.com/site/pdf/Patent-Marking.pdf. ON Semiconductor reserves the right to make changes without further notice to any products herein. ON Semiconductor makes no warranty, representation or guarantee regarding the suitability of its products for any particular purpose, nor does ON Semiconductor assume any liability arising out of the application or use of any product or circuit, and specifically disclaims any and all liability, including without limitation special, consequential or incidental damages. Buyer is responsible for its products and applications using ON Semiconductor products, including compliance with all laws, regulations and safety requirements or standards, regardless of any support or applications information provided by ON Semiconductor. "Typical" parameters which may be provided in ON Semiconductor data sheets and/or specifications can and do vary in different applications and actual performance may vary over time. All operating parameters, including "Typicals" must be validated for each customer application by customer's technical experts. ON Semiconductor does not convey any license under its patent rights nor the rights of others. ON Semiconductor products are not designed, intended, or authorized for use as a critical component in life support systems or any FDA Class 3 medical devices or medical devices with a same or similar classification in a foreign jurisdiction or any devices intended for implantation in the human body. Should Buyer purchase or use ON Semiconductor products for any such unintended or unauthorized application, Buyer shall indemnify and hold ON Semiconductor and its officers, employees, subsidiaries, affiliates, and distributors harmless against all claims, costs, damages, and expenses, and reasonable attorney fees arising out of, directly or indirectly, any claim of personal injury or death associated with such unintended or unauthorized use, even if such claim alleges that ON Semiconductor was negligent regarding the design or manufacture of the part. ON Semiconductor is an Equal Opportunity/Affirmative Action Employer. This literature is subject to all applicable copyright laws and is not for resale in any manner.

PUBLICATION ORDERING INFORMATION

LITERATURE FULFILLMENT:

Literature Distribution Center for ON Semiconductor
19521 E. 32nd Pkwy, Aurora, Colorado 80011 USA
Phone: 303-675-2175 or 800-344-3860 Toll Free USA/Canada
Fax: 303-675-2176 or 800-344-3867 Toll Free USA/Canada
Email: orderlit@onsemi.com

N. American Technical Support: 800-282-9855 Toll Free
USA/Canada
Europe, Middle East and Africa Technical Support:
Phone: 421 33 790 2910
Japan Customer Focus Center
Phone: 81-3-5817-1050

ON Semiconductor Website: www.onsemi.com
Order Literature: <http://www.onsemi.com/orderlit>
For additional information, please contact your local
Sales Representative

X-ON Electronics

Largest Supplier of Electrical and Electronic Components

Click to view similar products for [Transistor Output Optocouplers](#) category:

Click to view products by [ON Semiconductor](#) manufacturer:

Other Similar products are found below :

[LTV-814S-TA](#) [LTV-824HS](#) [66095-001](#) [6N136-X017T](#) [MCT6-X007](#) [MOC8101-X017T](#) [PS2561A-1-W-A](#) [PS2561B-1-L-A](#) [PS2561L-1-V-A](#)
[MRF658](#) [IL755-1X007](#) [ILD2-X006](#) [ILD74-X001](#) [ILQ615-2X017](#) [ILQ615-3X016](#) [LDA102S](#) [LDA110S](#) [SFH615AGR-X007T](#) [PS2561-1-V-](#)
[W-A](#) [PS2561AL-1-V-A](#) [PS2561L1-1-L-A](#) [PS2701A-1-F3-P-A](#) [PS2801-1-F3-P-A](#) [PS2911-1-L-AX](#) [CNY17-2X017](#) [CNY17-4X001](#) [CNY17-](#)
[4X017](#) [CNY17F-1X007](#) [CNY17F-2X017](#) [CNY17F-4X001](#) [CNY17G-1](#) [LTV-214](#) [LTV-702VB](#) [LTV-733S](#) [LTV-816S-TA](#) [LTV-825S](#)
[TCET1113](#) [TCET2100](#) [4N25-X007T](#) [IL215AT](#) [ILD615-1X007](#) [ILQ2-X007](#) [VOS615A-2T](#) [WPPC-A11066AA](#) [WPPC-A11066AD](#) [WPPC-](#)
[A11084ASS](#) [WPPC-A21068AA](#) [WPPC-D11066AA](#) [WPPC-D21068ED](#) [WPPC-D410616EA](#)