

# NPN Epitaxial Silicon Transistor

## KSC1815

### Features

- Audio Frequency Amplifier and High-Frequency OSC
- Complement to KSA1015
- Collector-Base Voltage:  $V_{CBO} = 50\text{ V}$
- This is a Pb-Free Device

### MAXIMUM RATINGS (Values are at $T_A = 25^\circ\text{C}$ unless otherwise noted.)

Symbol	Parameter	Value	Unit
$V_{CBO}$	Collector-Base Voltage	60	V
$V_{CEO}$	Collector-Emitter Voltage	50	V
$V_{EBO}$	Emitter-Base Voltage	5	V
$I_C$	Collector Current	150	mA
$I_B$	Base Current	50	mA
$T_J$	Junction Temperature	150	$^\circ\text{C}$
$T_{STG}$	Storage Temperature Range	-55 to 150	$^\circ\text{C}$

Stresses exceeding those listed in the Maximum Ratings table may damage the device. If any of these limits are exceeded, device functionality should not be assumed, damage may occur and reliability may be affected.

### THERMAL CHARACTERISTICS (Values are at $T_A = 25^\circ\text{C}$ unless otherwise noted.) (Note 1)

Symbol	Parameter	Max.	Unit
$P_D$	Total Device Dissipation	400	mW
	Derate Above $25^\circ\text{C}$	3.2	mW/ $^\circ\text{C}$
$R_{\theta JA}$	Thermal Resistance, Junction to Ambient	312	$^\circ\text{C}/\text{W}$

1. PCB size: FR-4, 76 mm x 114 mm x 1.57 mm (3.0 inch x 4.5 inch x 0.062 inch) with minimum land pattern size.



ON Semiconductor®

[www.onsemi.com](http://www.onsemi.com)



1. Emitter
2. Collector
3. Base

TO-92 3 4.83x4.76  
LEADFORMED  
CASE 135AR

### MARKING DIAGRAM

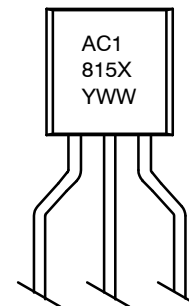

A = Assembly Code  
C1815 = Device Code  
X = O / Y / GR / L  
YWW = Date Code

### ORDERING INFORMATION

Device	Package	Shipping
KSC1815YTA	TO-92 3L (Pb-Free)	2000 / Fan-Fold

# KSC1815

## ELECTRICAL CHARACTERISTICS (Values are at $T_A = 25^\circ\text{C}$ unless otherwise noted.)

Symbol	Parameter	Conditions	Min	Typ	Max	Unit
$BV_{CBO}$	Collector-Base Voltage	$I_C = 1\text{ mA}, I_E = 0$	60			V
$BV_{CEO}$	Collector-Emitter Voltage	$I_C = 10\text{ mA}, I_B = 0$	50			V
$BV_{EBO}$	Emitter-Base Voltage	$I_E = 10\text{ }\mu\text{A}, I_C = 0$	5			V
$I_{CBO}$	Collector Cut-Off Current	$V_{CB} = 60\text{ V}, I_E = 0$			0.1	$\mu\text{A}$
$I_{EBO}$	Emitter Cut-Off Current	$V_{EB} = 5\text{ V}, I_C = 0$			0.1	$\mu\text{A}$
$V_{CE(sat)}$	Collector-Emitter Saturation Voltage	$I_C = 100\text{ mA}, I_B = 10\text{ mA}$		0.10	0.25	V
$V_{BE(sat)}$	Base-Emitter Saturation Voltage	$I_C = 100\text{ mA}, I_B = 10\text{ mA}$			1.0	V
$h_{FE1}$	DC Current Gain	$V_{CE} = 6\text{ V}, I_C = 2\text{ mA}$	70		700	
$h_{FE2}$		$V_{CE} = 6\text{ V}, I_C = 150\text{ mA}$	25			
$f_T$	Current Gain Bandwidth Product	$V_{CE} = 10\text{ V}, I_C = 1\text{ mA}$	80			MHz
$C_{ob}$	Output Capacitance	$V_{CB} = 10\text{ V}, I_E = 0, f = 1\text{ MHz}$		2.0	3.0	pF
NF	Noise Figure	$V_{CE} = 6\text{ V}, I_C = 0.1\text{ mA},$ $R_S = 10\text{ k}\Omega, f = 1\text{ kHz}$		1.0	10.0	dB

Product parametric performance is indicated in the Electrical Characteristics for the listed test conditions, unless otherwise noted. Product performance may not be indicated by the Electrical Characteristics if operated under different conditions.

## $h_{FE}$ CLASSIFICATION

Classification	O	Y	GR	L
$H_{FE1}$	70 ~ 140	120 ~ 240	200 ~ 400	350 ~ 700

TYPICAL PERFORMANCE CHARACTERISTICS

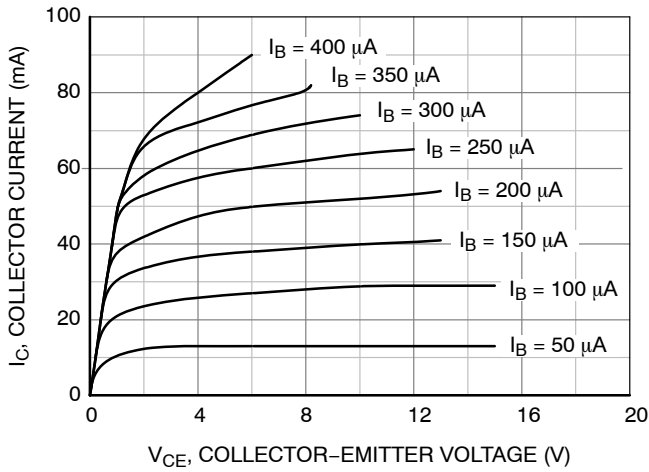

Figure 1. Static Characteristic

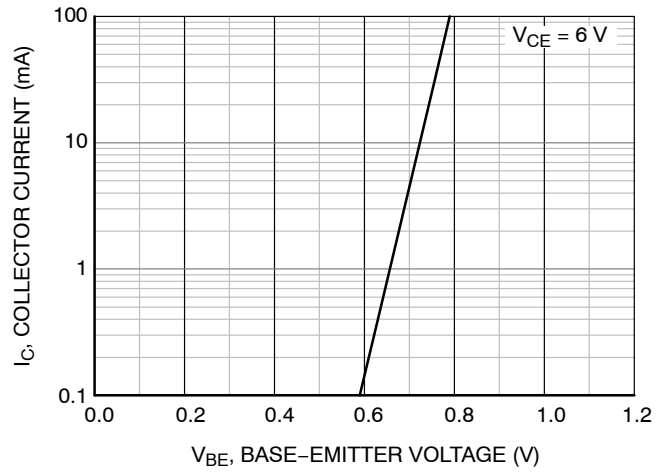

Figure 2. Static Characteristic

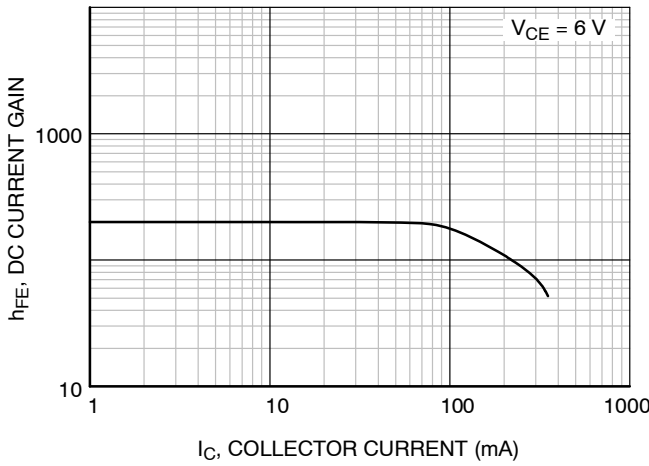

Figure 3. DC Current Gain

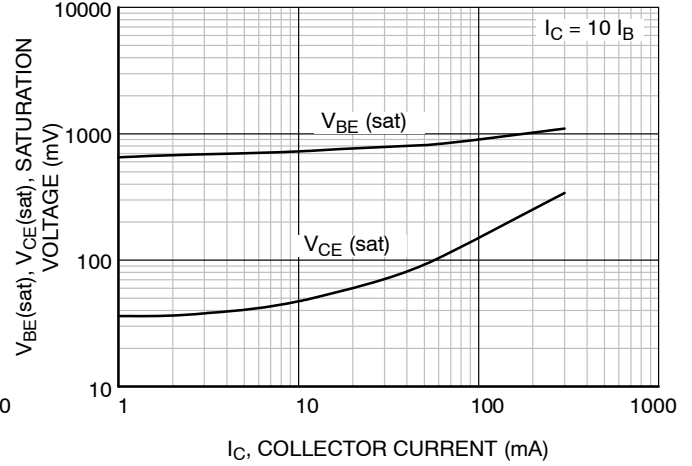

Figure 4. Base-Emitter Saturation Voltage and Collector-Emitter Saturation Voltage

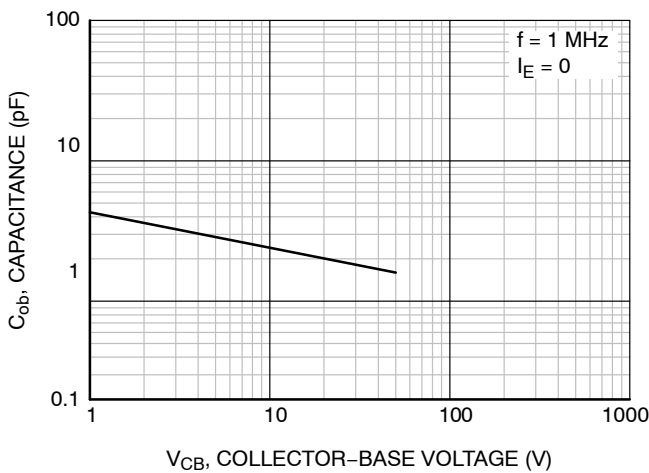

Figure 5. Output Capacitance

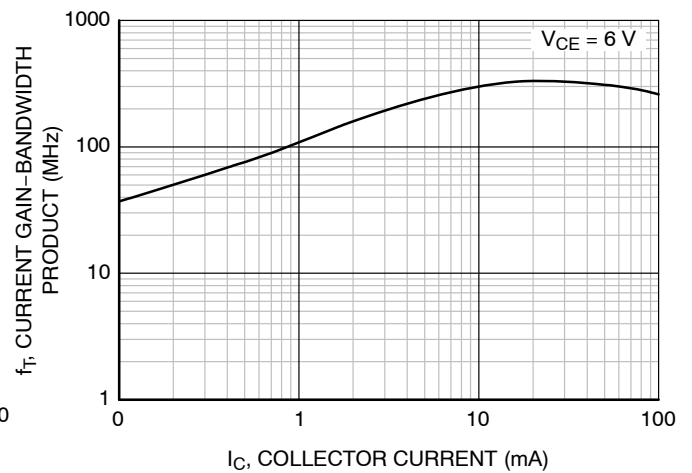
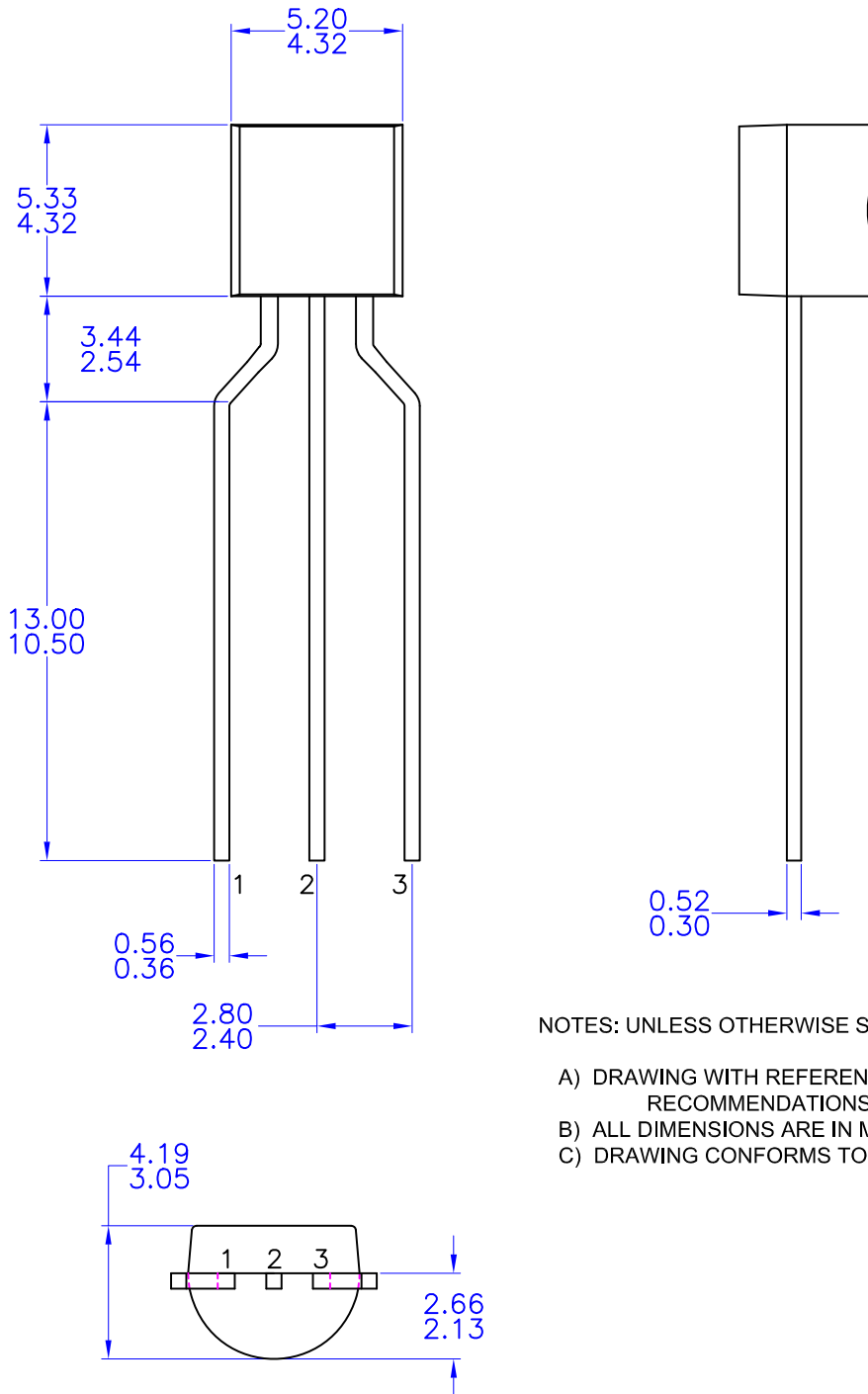

Figure 6. Current Gain Bandwidth Product

**TO-92 3 4.83x4.76 LEADFORMED**  
**CASE 135AR**  
**ISSUE O**

DATE 30 SEP 2016



NOTES: UNLESS OTHERWISE SPECIFIED

- A) DRAWING WITH REFERENCE TO JEDEC TO-92 RECOMMENDATIONS.
- B) ALL DIMENSIONS ARE IN MILLIMETERS.
- C) DRAWING CONFORMS TO ASME Y14.5M-1994

<b>DOCUMENT NUMBER:</b>	<b>98AON13879G</b>	Electronic versions are uncontrolled except when accessed directly from the Document Repository. Printed versions are uncontrolled except when stamped "CONTROLLED COPY" in red.
<b>DESCRIPTION:</b>	<b>TO-92 3 4.83X4.76 LEADFORMED</b>	<b>PAGE 1 OF 1</b>

ON Semiconductor and  are trademarks of Semiconductor Components Industries, LLC dba ON Semiconductor or its subsidiaries in the United States and/or other countries. ON Semiconductor reserves the right to make changes without further notice to any products herein. ON Semiconductor makes no warranty, representation or guarantee regarding the suitability of its products for any particular purpose, nor does ON Semiconductor assume any liability arising out of the application or use of any product or circuit, and specifically disclaims any and all liability, including without limitation special, consequential or incidental damages. ON Semiconductor does not convey any license under its patent rights nor the rights of others.

**onsemi**, **Onsemi**, and other names, marks, and brands are registered and/or common law trademarks of Semiconductor Components Industries, LLC dba "**onsemi**" or its affiliates and/or subsidiaries in the United States and/or other countries. **onsemi** owns the rights to a number of patents, trademarks, copyrights, trade secrets, and other intellectual property. A listing of **onsemi**'s product/patent coverage may be accessed at [www.onsemi.com/site/pdf/Patent-Marking.pdf](http://www.onsemi.com/site/pdf/Patent-Marking.pdf). **onsemi** reserves the right to make changes at any time to any products or information herein, without notice. The information herein is provided "as-is" and **onsemi** makes no warranty, representation or guarantee regarding the accuracy of the information, product features, availability, functionality, or suitability of its products for any particular purpose, nor does **onsemi** assume any liability arising out of the application or use of any product or circuit, and specifically disclaims any and all liability, including without limitation special, consequential or incidental damages. Buyer is responsible for its products and applications using **onsemi** products, including compliance with all laws, regulations and safety requirements or standards, regardless of any support or applications information provided by **onsemi**. "Typical" parameters which may be provided in **onsemi** data sheets and/or specifications can and do vary in different applications and actual performance may vary over time. All operating parameters, including "Typicals" must be validated for each customer application by customer's technical experts. **onsemi** does not convey any license under any of its intellectual property rights nor the rights of others. **onsemi** products are not designed, intended, or authorized for use as a critical component in life support systems or any FDA Class 3 medical devices or medical devices with a same or similar classification in a foreign jurisdiction or any devices intended for implantation in the human body. Should Buyer purchase or use **onsemi** products for any such unintended or unauthorized application, Buyer shall indemnify and hold **onsemi** and its officers, employees, subsidiaries, affiliates, and distributors harmless against all claims, costs, damages, and expenses, and reasonable attorney fees arising out of, directly or indirectly, any claim of personal injury or death associated with such unintended or unauthorized use, even if such claim alleges that **onsemi** was negligent regarding the design or manufacture of the part. **onsemi** is an Equal Opportunity/Affirmative Action Employer. This literature is subject to all applicable copyright laws and is not for resale in any manner.

## PUBLICATION ORDERING INFORMATION

### LITERATURE FULFILLMENT:

Email Requests to: [orderlit@onsemi.com](mailto:orderlit@onsemi.com)

**onsemi Website:** [www.onsemi.com](http://www.onsemi.com)

### TECHNICAL SUPPORT

**North American Technical Support:**  
Voice Mail: 1 800-282-9855 Toll Free USA/Canada  
Phone: 011 421 33 790 2910

**Europe, Middle East and Africa Technical Support:**

Phone: 00421 33 790 2910

For additional information, please contact your local Sales Representative

## X-ON Electronics

Largest Supplier of Electrical and Electronic Components

*Click to view similar products for [Bipolar Transistors - BJT category](#):*

*Click to view products by [ON Semiconductor manufacturer](#):*

Other Similar products are found below :

[619691C](#) [MCH4017-TL-H](#) [BC546/116](#) [BC557/116](#) [BSW67A](#) [NTE158](#) [NTE187A](#) [NTE195A](#) [NTE2302](#) [NTE2330](#) [NTE63](#) [C4460](#)  
[2SA1419T-TD-H](#) [2SA1721-O\(TE85L,F\)](#) [2SA2126-E](#) [2SB1204S-TL-E](#) [2SC5488A-TL-H](#) [2SD2150T100R](#) [SP000011176](#) [FMMTA92QTA](#)  
[2N2369ADCSM](#) [2SC2412KT146S](#) [2SC5490A-TL-H](#) [2SD1816S-TL-E](#) [2SD1816T-TL-E](#) [CMXT2207 TR](#) [CPH6501-TL-E](#) [MCH4021-TL-E](#)  
[US6T6TR](#) [732314D](#) [CMXT3906 TR](#) [CPH3121-TL-E](#) [CPH6021-TL-H](#) [873787E](#) [UMX21NTR](#) [EMT2T2R](#) [MCH6102-TL-E](#) [FP204-TL-E](#)  
[NJL0302DG](#) [2N3583](#) [2SA1434-TB-E](#) [2SC3143-4-TB-E](#) [2SD1621S-TD-E](#) [NTE103](#) [30A02MH-TL-E](#) [NSV40301MZ4T1G](#) [NTE101](#) [NTE13](#)  
[NTE15](#) [NTE16001](#)