



**LA1260**

**FM/AM Tuner System  
for Radio-Cassette Recorders, Music Centers**

**Functions**

FM : IF amplifier, quadrature detector, AF preamplifier, tuning indicator drive output.  
 AM : RF amplifier, MIX, OSC (with ALC), IF amplifier, Detector, AGC, tuning indicator drive.

**Features**

- Minimum number of external parts required (No AM detection coil required).
- High S/N : FM 81dB  
                   AM 53dB
- Low-level AM oscillator with ALC : Pin 16 OSC output  
   MW 130mV  
   SW 70 mV to 90 mV  
   (7MHz) (24MHz)
- Less AM whistle interference : Whistle 1% at input 100dB/m.
- On-chip LED tuning indicator driver.
- On-chip FM/AM selector.
- Independent FM/AM output pins : Possible to set FM/AM frequency characteristic independently.

**Package Dimensions**

unit : mm  
**3006B-DIP16**

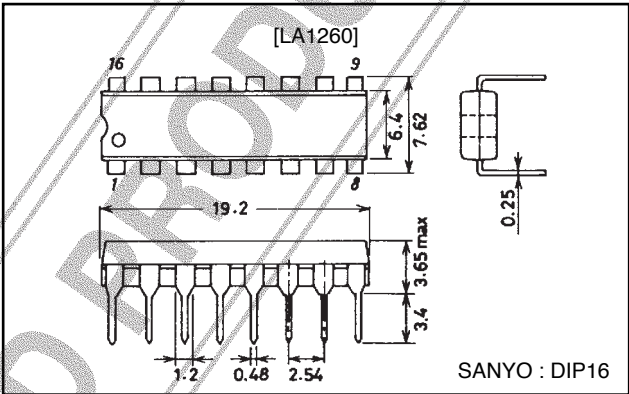

**Specifications**

**Maximum Ratings** at Ta=25°C, See specified Test Circuit.

| Parameter                   | Symbol              | Conditions           | Ratings     | Unit |
|-----------------------------|---------------------|----------------------|-------------|------|
| Maximum supply voltage      | V <sub>CC</sub> max | Pins 6, 12           | 9           | V    |
| Maximum current drain       | I <sub>CC</sub> max | Pins 6+7+12          | 50          | mA   |
| Flow-in current             | I <sub>7</sub>      | Pin 7                | 20          | mA   |
| Flow-out current            | I <sub>15</sub>     | Pin 15               | 0.1         | mA   |
| Allowable power dissipation | P <sub>d</sub> max  | T <sub>a</sub> ≤70°C | 450         | mW   |
| Operating temperature       | T <sub>opr</sub>    |                      | -20 to +70  | °C   |
| Storage temperature         | T <sub>stg</sub>    |                      | -40 to +125 | °C   |

**Operating Conditions** at Ta=25°C

| Parameter                     | Symbol             | Conditions | Ratings    | Unit |
|-------------------------------|--------------------|------------|------------|------|
| Recommended operating voltage | V <sub>CC</sub>    |            | 4.5        | V    |
| Operating voltage range       | V <sub>CC</sub> op |            | 3.0 to 8.0 | V    |

# LA1260

**Operating Characteristics** at  $T_a=25^\circ\text{C}$ ,  $V_{CC}=4.5\text{V}$ , See specified Test Circuit

| Parameter                                  | Symbol             | Conditions   | Ratings |       |       | Unit     |
|--|--------------------|--|---------|-------|-------|----------|
|  |                    |  | min     | typ   | max   |          |
| [AM Characteristics : $f=1\text{MHz}$ ]    |                    |  |         |       |       |          |
| Quiescent current                          | $I_{CCO\text{AM}}$ | $V_{IN}=\text{No input}$   |         | 7.5   | 10.5  | mA       |
| Detection output                           | $V_{O1}$           | $V_{IN}=23\text{dB}\mu$ , 400Hz-30% mod.                         | -33     | -28   | -23   | dBm      |
|  |                    |  | 17.3    | 31    | 55    | mV       |
| S/N ratio                                  | S/N1               | $V_{IN}=23\text{dB}\mu$ , 400Hz-30% mod.                         | 18.0    | 21.5  |       | dB       |
| Detection output                           | $V_{O2}$           | $V_{IN}=60\text{dB}\mu$ , 400Hz-30% mod.                         | -19.0   | -16.0 | -13.0 | dBm      |
|  |                    |  | 87      | 122   | 174   | mV       |
| S/N ratio                                  | S/N2               | $V_{IN}=60\text{dB}\mu$ , 400Hz-30% mod.                         | 48      | 53    |       | dB       |
| Total harmonic distortion                  | THD1               | $V_{IN}=60\text{dB}\mu$ , 400Hz-30% mod.                         |         | 0.45  | 1.3   | %        |
|  | THD2               | $V_{IN}=100\text{dB}\mu$ , 400Hz-30% mod.                        |         | 1.5   | 3.0   | %        |
| LED lighting voltage                       | $V_{LEDAM}$        | $I_C=1\text{mA}$   | 22      | 30    | 38    | dBm      |
| Oscillation output (24MHz)                 | $V_{OSC24M}$       |  | 60      | 86    | 120   | mV       |
| [FM Characteristics : $f=10.7\text{MHz}$ ] |                    |  |         |       |       |          |
| Quiescent current                          | $I_{CCO\text{FM}}$ | $V_{IN}=\text{No input}$   |         | 8.5   | 12.0  | mA       |
| -3dB sensitivity                           | $V_{IN\text{lim}}$ | -3dB down, 400Hz-100% mod.                                       |         | 35    | 42    | dB $\mu$ |
| Demodulation output                        | $V_{O3}$           | $V_{IN}=80\text{dB}\mu$ , 400Hz-100% mod.                        | -12.5   | -9.5  | -6.5  | dBm      |
|  |                    |  | 183     | 260   | 367   | mV       |
| S/N ratio                                  | S/N3               | $V_{IN}=80\text{dB}\mu$ , 400Hz-100% mod.                        | 77      | 81    |       | dB       |
|  | S/N4               | $V_{IN}=80\text{dB}\mu$ , 400Hz-30% mod.                         |         | 71    |       | dB       |
| Total harmonic distortion                  | THD3               | $V_{IN}=80\text{dB}\mu$ , 400Hz-100% mod.                        |         | 0.55  | 1.2   | %        |
|  | THD4               | $V_{IN}=80\text{dB}\mu$ , 400Hz-30% mod.                         |         | 0.05  |       | %        |
| LED lighting voltage                       | $V_{LEDFM}$        | $I_L=1\text{mA}$   |         | 39    | 49    | dB $\mu$ |
| AM rejection ratio                         | AMR                | $V_{IN}=80\text{dB}\mu$ , 400Hz-100% FM mod.<br>1kHz-30% AM mod. |         | 60    |       | dB       |

## Equivalent Circuit Block Diagram

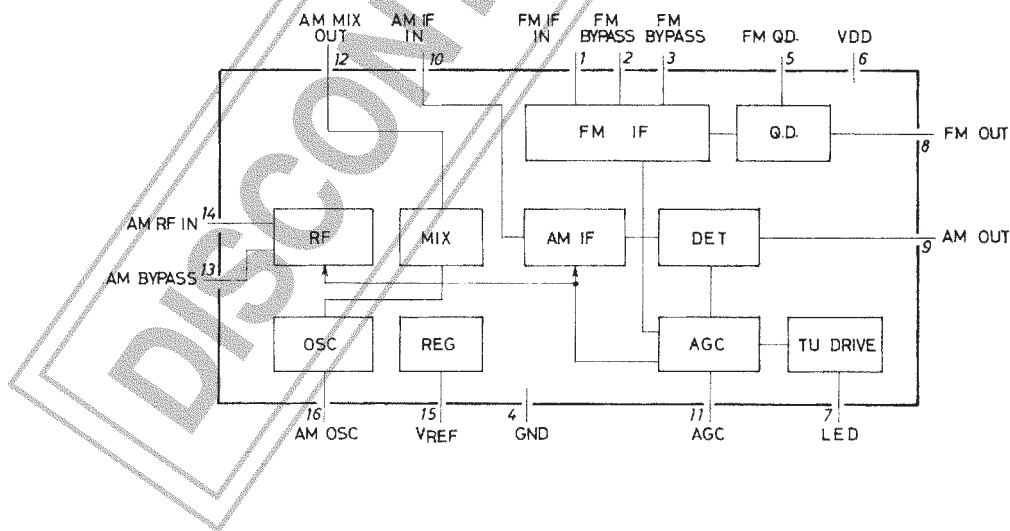

Test Circuit

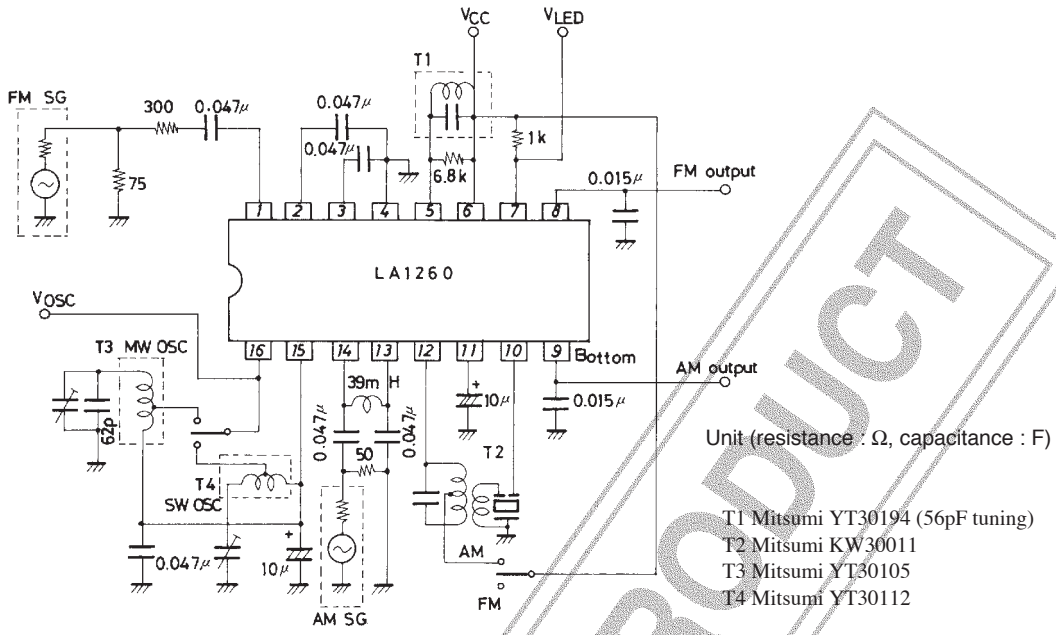

Proper Cares in Using the IC

External parts placement and pattern

- The AM local oscillation parts, AM local oscillation coil, and antenna circuit parts such as bar antenna must be separated from each other as far as possible to prevent Qs from worsening.
- Pin 16 (AM oscillation injection pin) and pin 14 (RF input pin) must be separated from each other on the pattern as shown in Figure A below. Care should be taken not to make unwanted coupling by parallel wiring as shown in Figure B to prevent Qs from worsening.

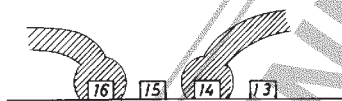

Figure A Good example

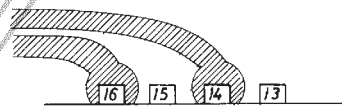

Figure B Bad example

FM quadrature detection coil

- The values recommended for the detection coil are shown below. (See Figure 1.)

Tuning capacitance : 56pF

Damping resistance : 6.8k $\Omega$

- Values other than recommended provide the LED drive characteristic as shown below.

|                    | Value increased  | Value decreased  |
|--------------------|--|--|
| Tuning capacitance | <ul style="list-style-type: none"> <li>• Lighting is delayed.</li> <li>• No lighting may occur at low temperature.</li> </ul>        | <ul style="list-style-type: none"> <li>• Lighting is advanced.</li> <li>• Mislighting may occur in the absence of signal.</li> </ul> |
| Damping resistance | <ul style="list-style-type: none"> <li>• Lighting is advanced.</li> <li>• Mislighting may occur in the absence of signal.</li> </ul> | <ul style="list-style-type: none"> <li>• Lighting is delayed.</li> <li>• No lighting may occur at low temperature.</li> </ul>        |

If the product of tuning capacitance and damping resistance is equal to that of values recommended above (e. g. tuning capacitance=82pF, damping resistance=4.7k $\Omega$ ), other characteristics (demodulation output, S/N, THD, etc.) than the LED drive characteristic remain almost unaffected.

- For applications where a double tuning coil is used, refer to "Applications where a double coil is used" on page 13.

# LA1260

## How to apply FM AFC

The S curve at the FM output pin (pin 8) is as shown in Figure 1. Therefore, the domestic (Japan) band (lower local oscillation) use and foreign band (upper local oscillation) use differ as shown in Figures 2 and 3.

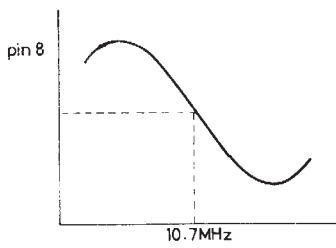

Figure 1

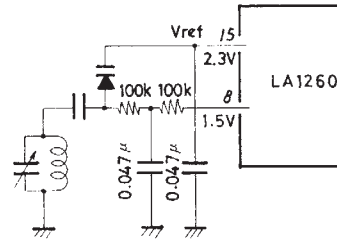

Figure 2 Domestic (lower local oscillation) band

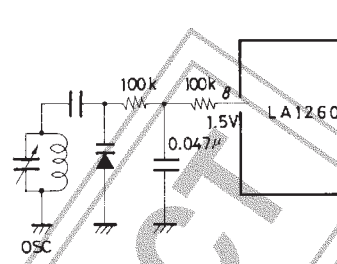
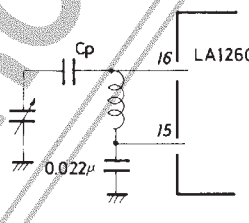
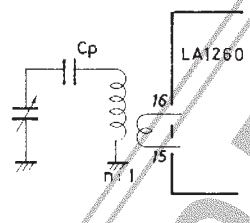
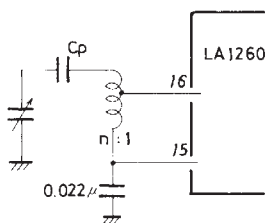

Figure 3 Foreign (upper local oscillation) band

Unit (resistance : Ω, capacitance : F)

## AM local oscillation

Since the LA1260 contains an ALC circuit, the oscillation level at pin 16 can be limited to 60 to 150mV in the following applications where a coil is used.



Unit (capacitance : F)

Stable oscillation occurs at a coil impedance of 5kΩ or greater viewed from across pins 16 and 15. Turn ratio  $n$  and  $Q_0$  must be determined so that the oscillation level at pin 16 becomes 75mV or greater for MW use and 60mV or greater for SW use.

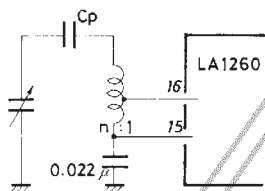

Figure 4

If turn ratio  $n$  is increased more than needed, the oscillation level at pin 16 drops, thereby lowering the maximum sensitivity as shown in Figure 5 and 6. Figure 7 shows the relation between turn ratio  $n$  and oscillation level at pin 16 in the MW band.

Unit (capacitance : F)

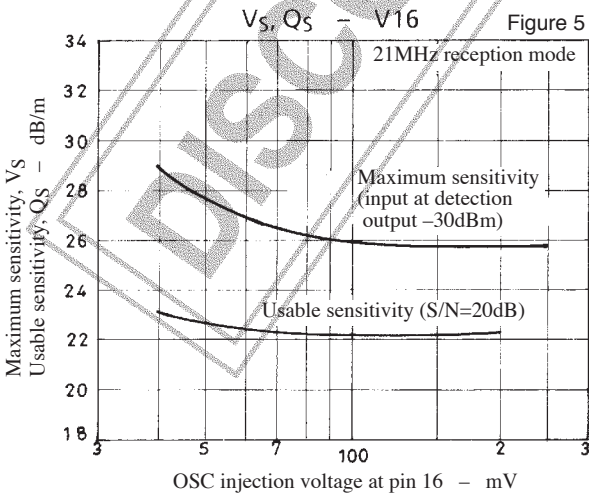

Figure 5

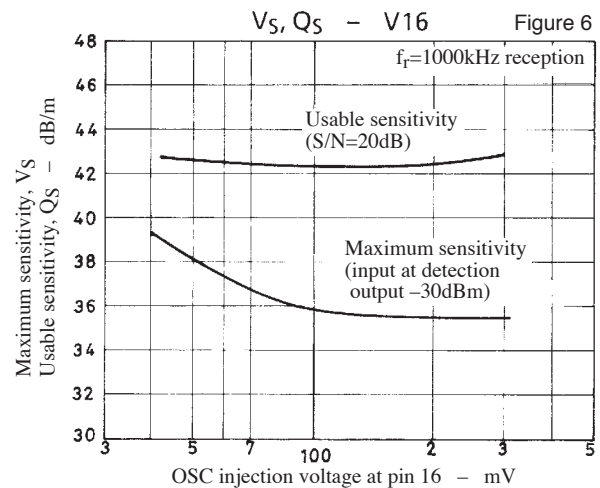
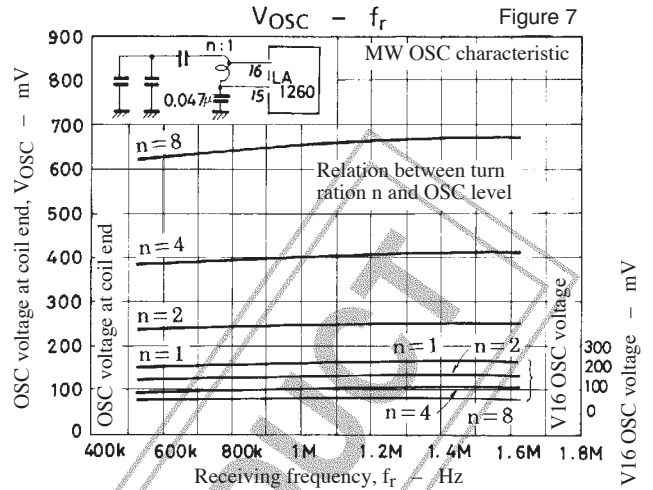
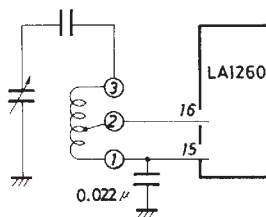

Figure 6



AM oscillation coil



Unit (capacitance : F)

Generally speaking, the following should be noted. Winding with loose coupling between 1 and 2 and between 1 and 3 must be avoided. (Particularly SW1, SW2).

To put in concretely, the pot core type is better than the screw core type which is loose in coupling. This prevents the local oscillation frequency from turning third resonance frequency related to the coupling coefficient.

LED unlighted time and distortion in AM (MW)

By increasing the value of the electrolytic capacitor for AGC at pin 11 (Figure 8), the distortion in the AM mode can be improved, but the LED unlighted time is made longer.  $10\mu F$  is recommended for obtaining the optimum LED unlighted time and distortion. The LED unlighted time is 200ms at this value (Approximately 400ms at  $22\mu F$ ).

FM-AM selection and dc level at pin 12

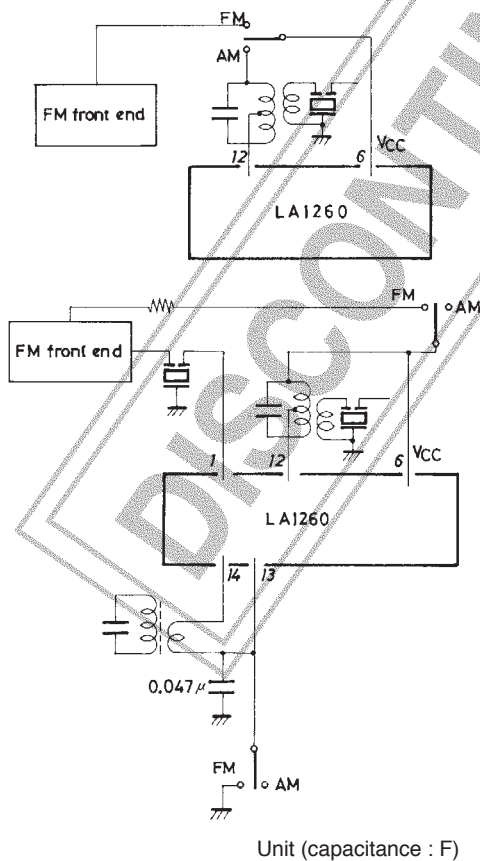

Unit (capacitance : F)

(1) Pin 12-used method=recommended circuit

The FM mode is entered with pin 12 open. When pin 12 and pin 6 are at the same potential in terms of DC, the AM circuit is turned on by the internal switch. It should be noted that the dynamic range is narrowed whether the potential at pin 12 is lower or high than that at pin 6.

(2) Pin 13-used method

The AM mode is entered with pin 13 open. When pin 13 is grounded, the FM circuit is turned on and the AM circuit is turned off by the internal switch. In this case, pin 12 and pin 6 ( $V_{CC}$ ) are at the same potential.

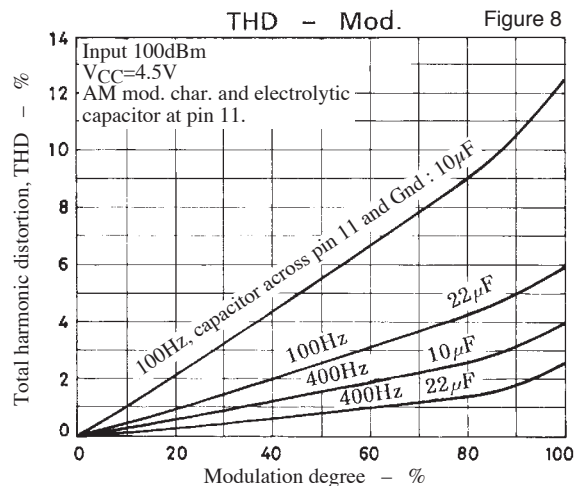

FM IF/MW Test Circuit

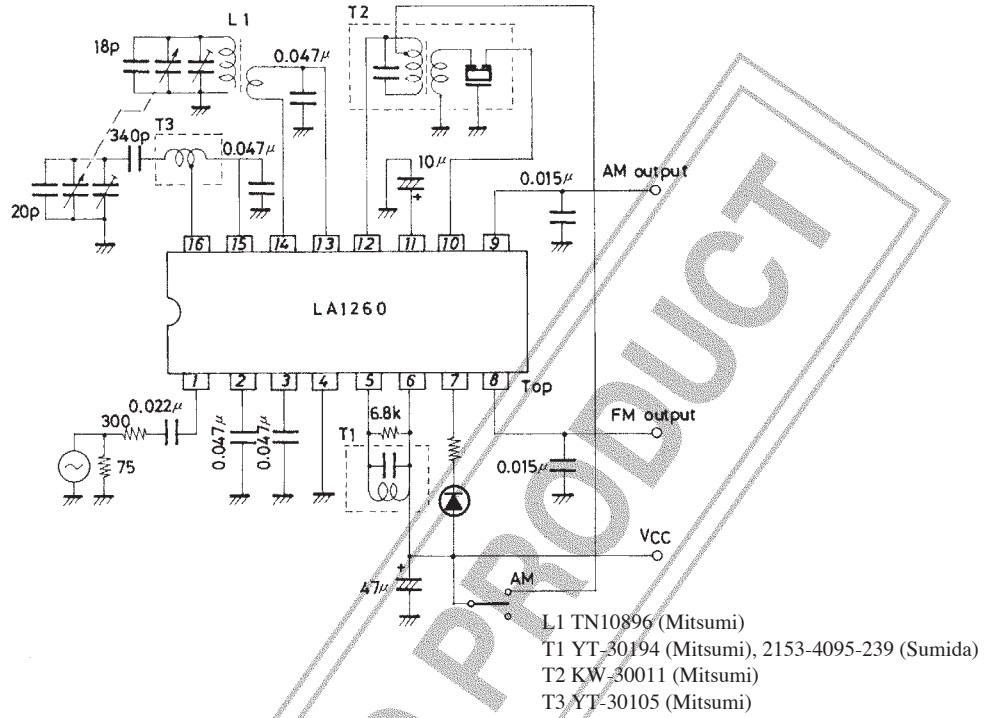

Unit (resistance : Ω, capacitance : F)

[FM Characteristics]

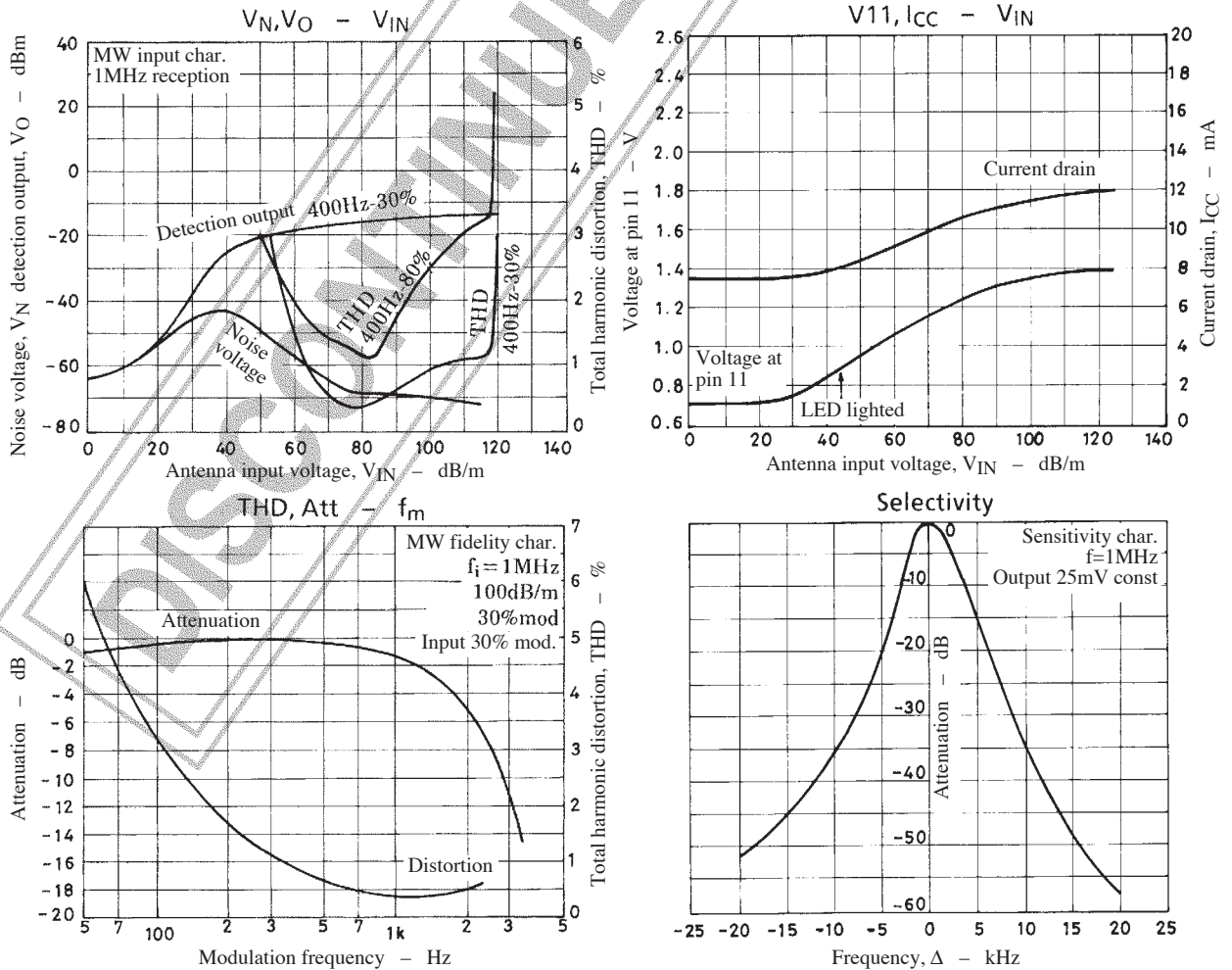

Detuning Characteristic

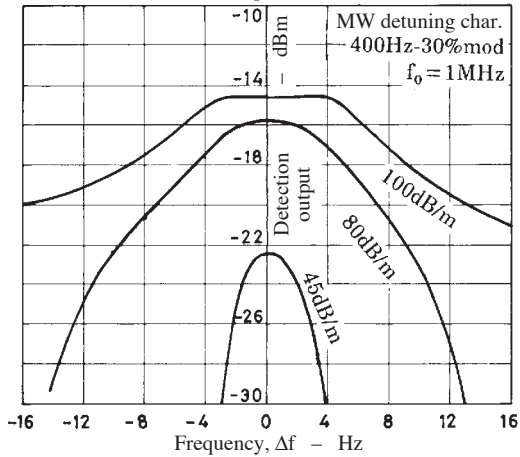

MW Receiving Characteristics

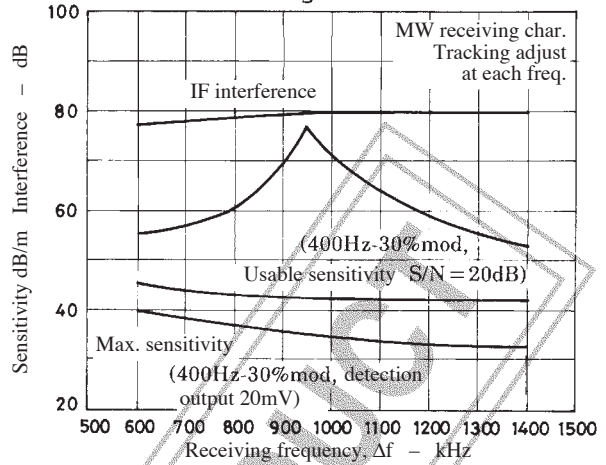

MW Receiving Characteristics

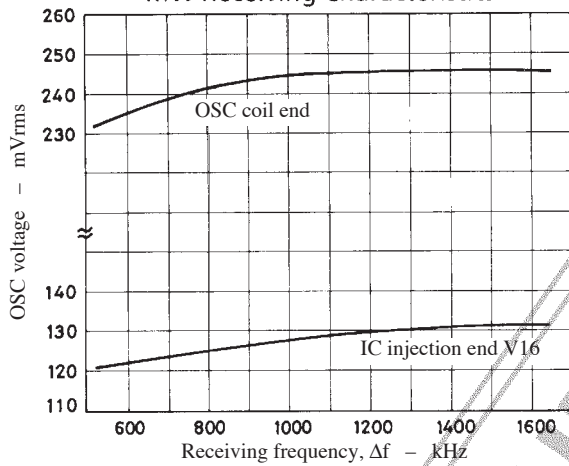

MW Receiving Characteristics

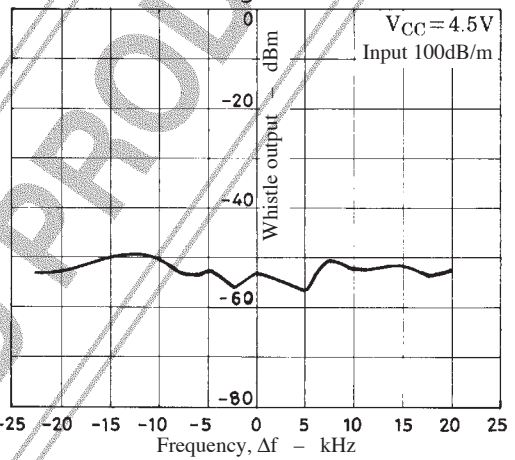

MW Beat Characteristics

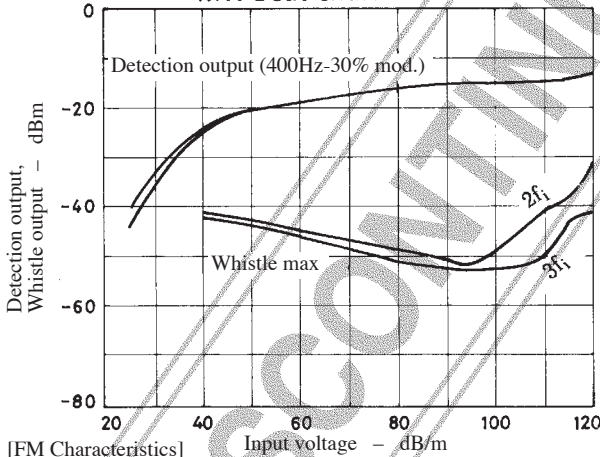

Spurious Response

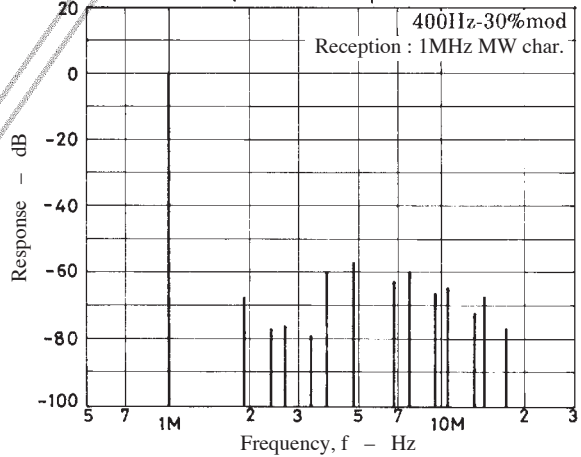

[FM Characteristics]

FM Receiving Characteristics

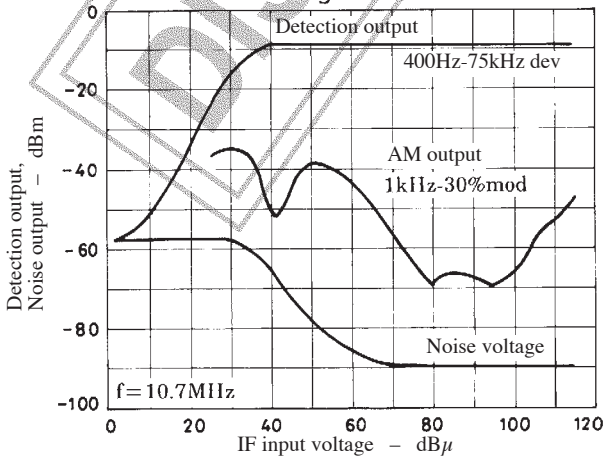

FM Receiving Characteristics

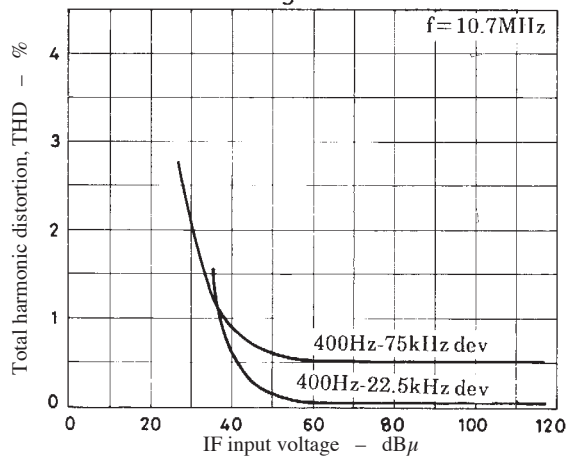

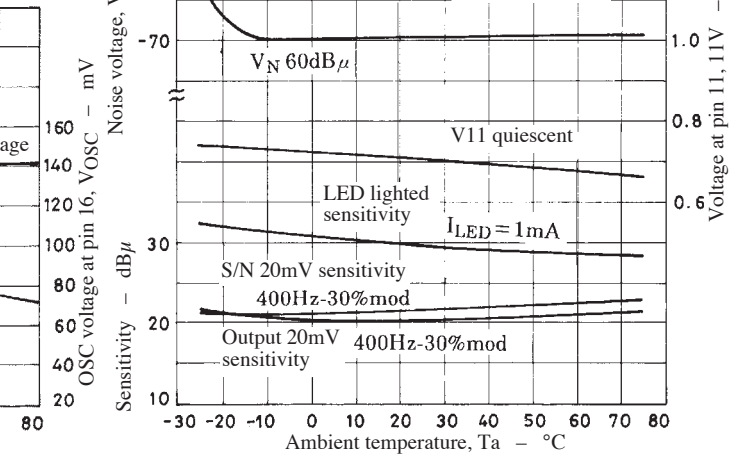
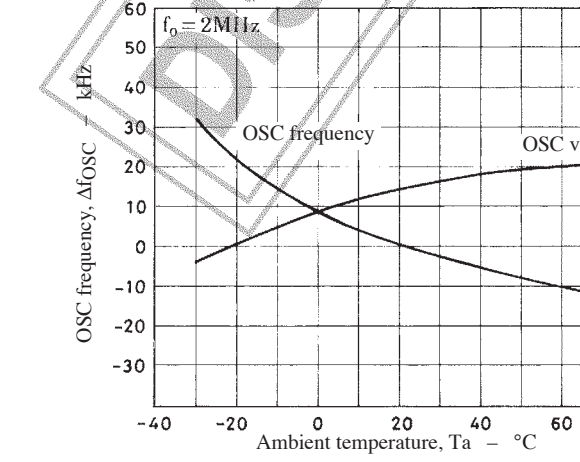
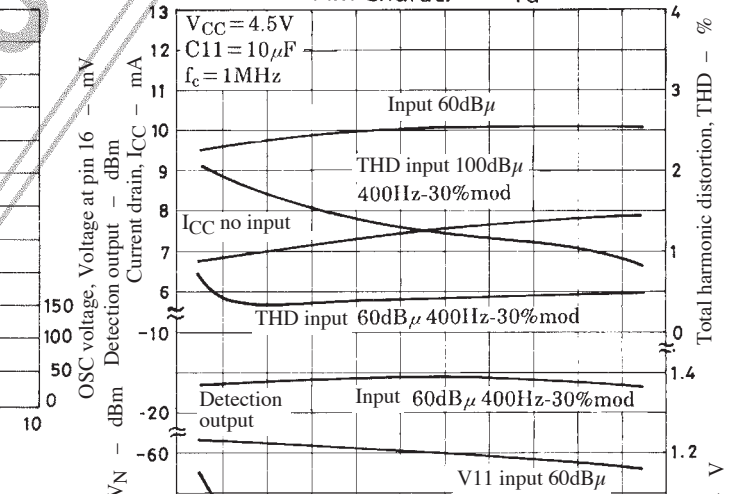
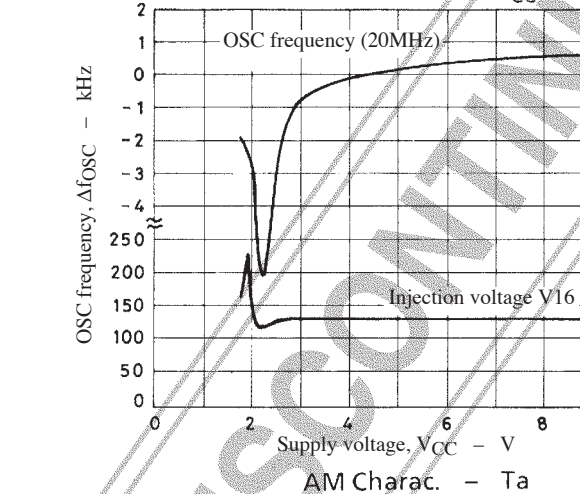
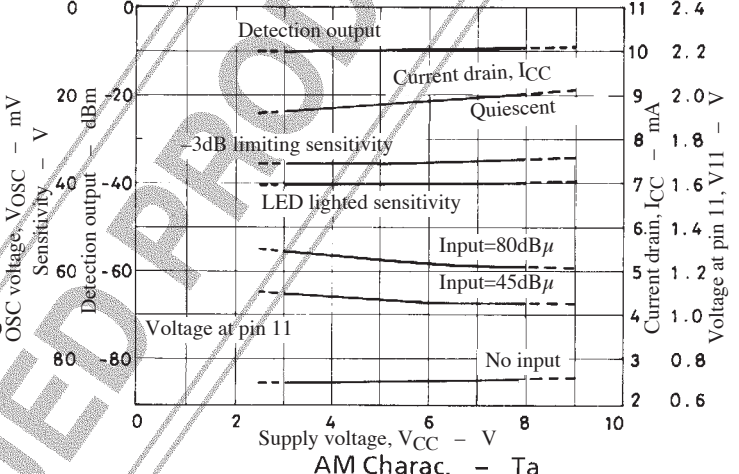
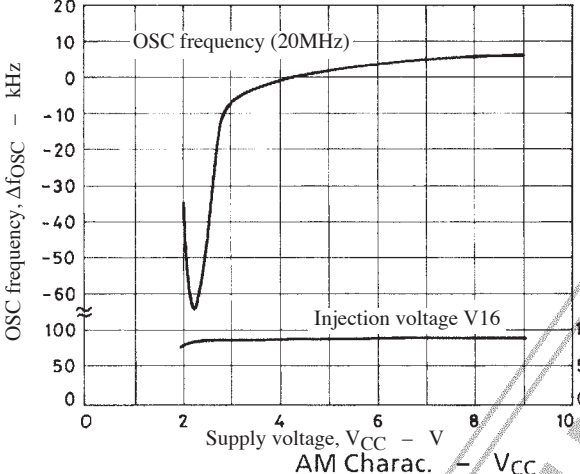
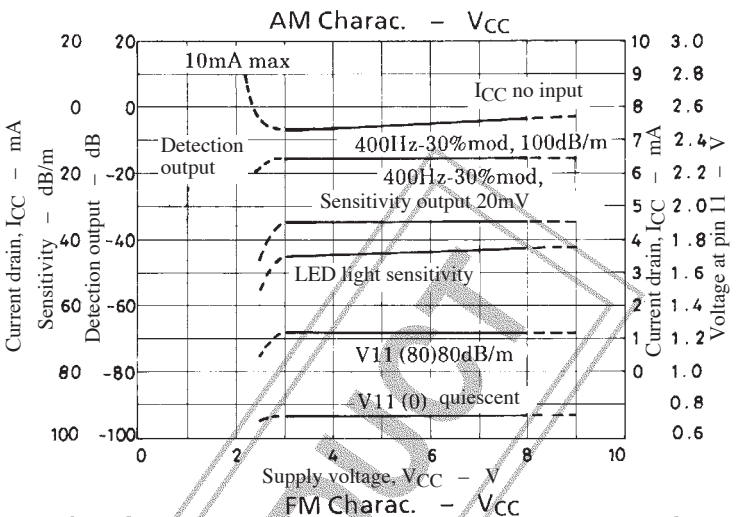
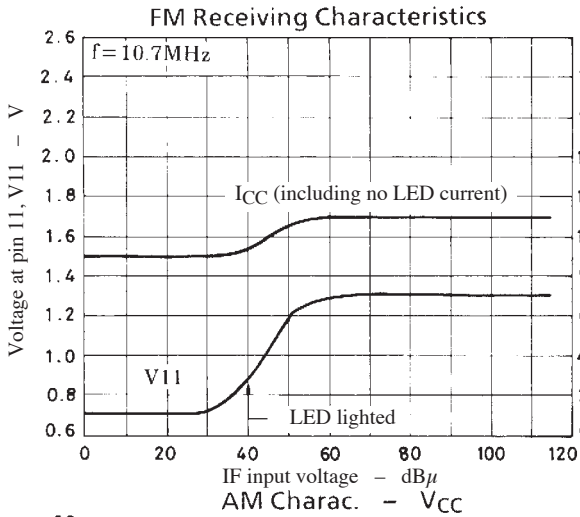



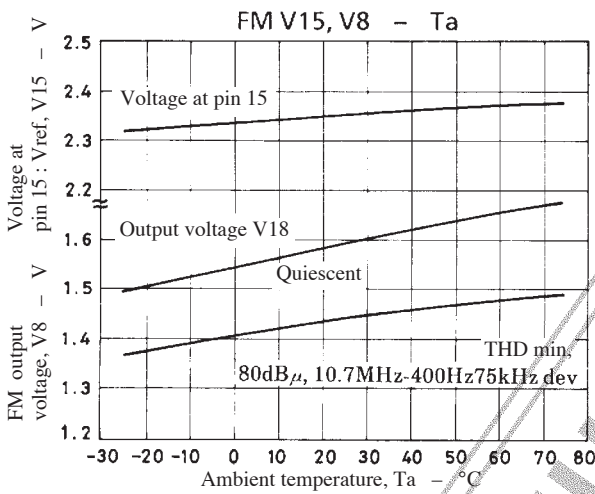
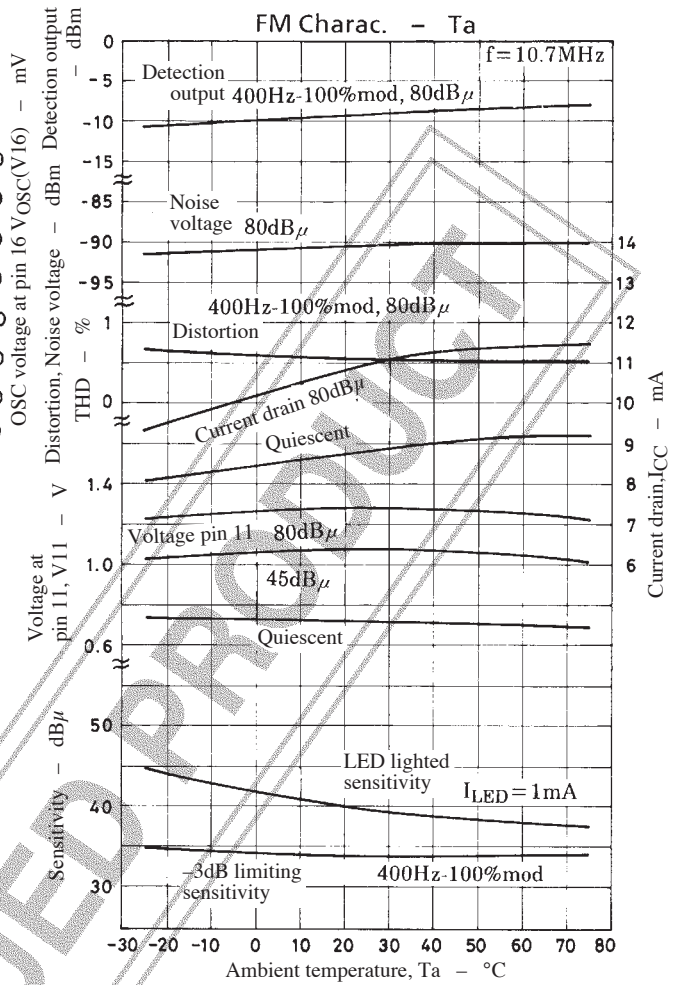
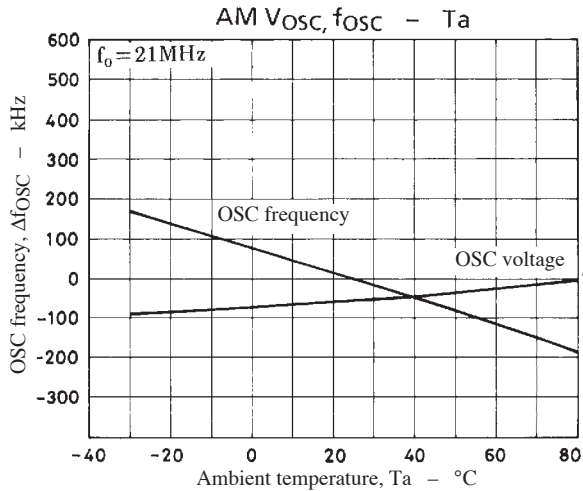

**Sample Application Circuit 1 : FM IF/SW2 (7.2 to 24.0MHz)**

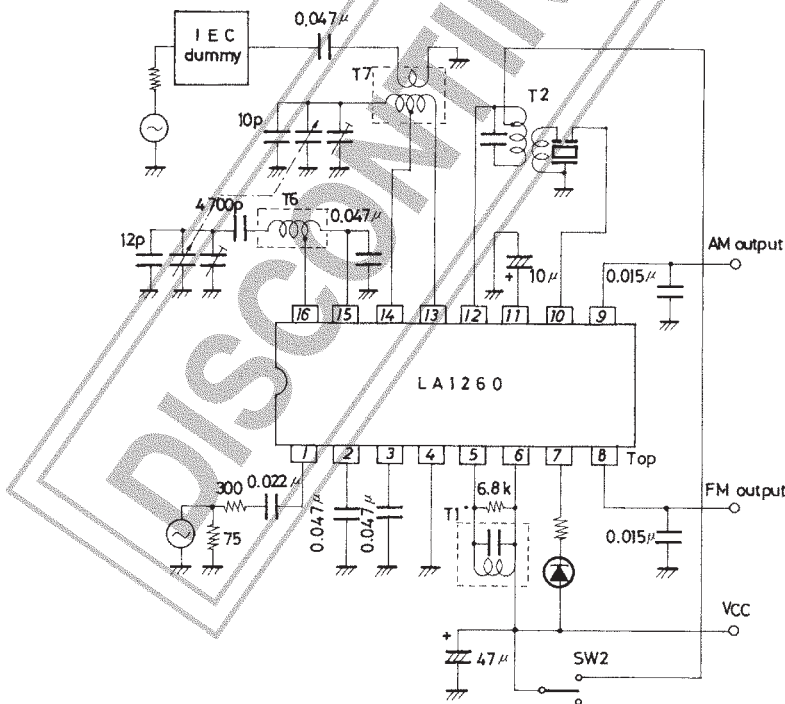

- T1 YT-30194 (Mitsumi), 2153-4095-339 (Sumida)
- T2 KW-30011 (Mitsumi)
- T6 YT-30112 (Mitsumi)
- T7 YT-30117 (Mitsumi), 2158-4140-044 (Sumida)

Unit (resistance :  $\Omega$ , capacitance : F)

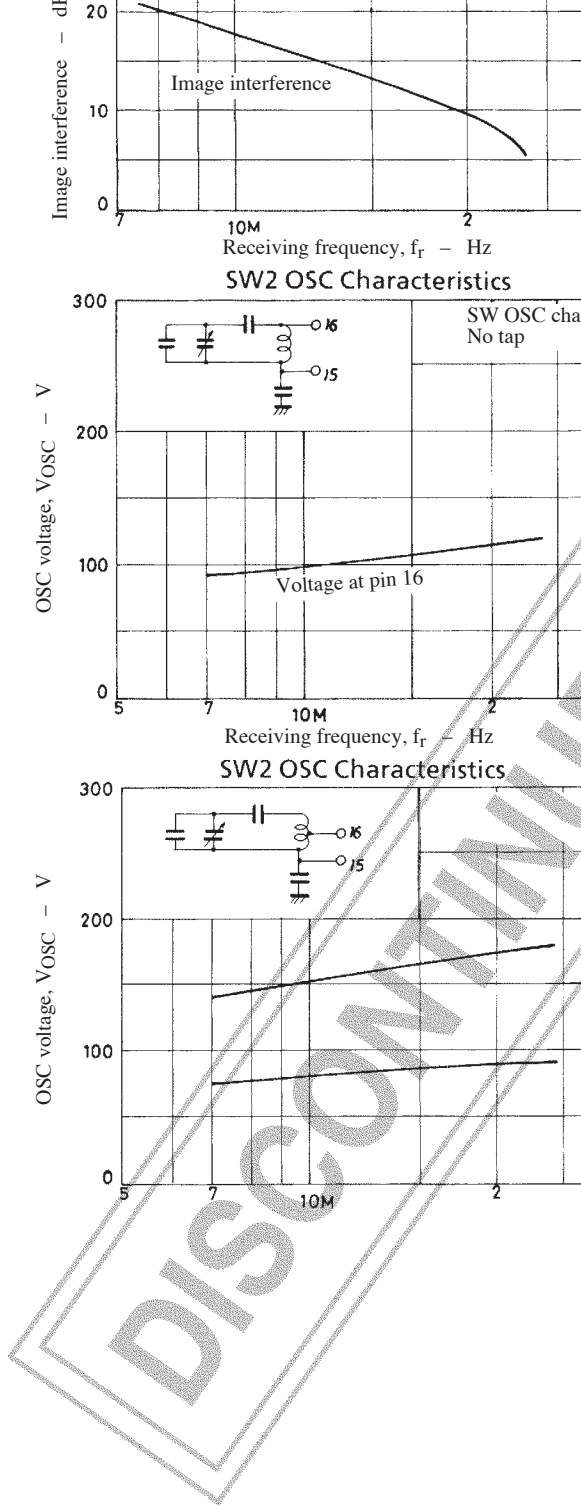
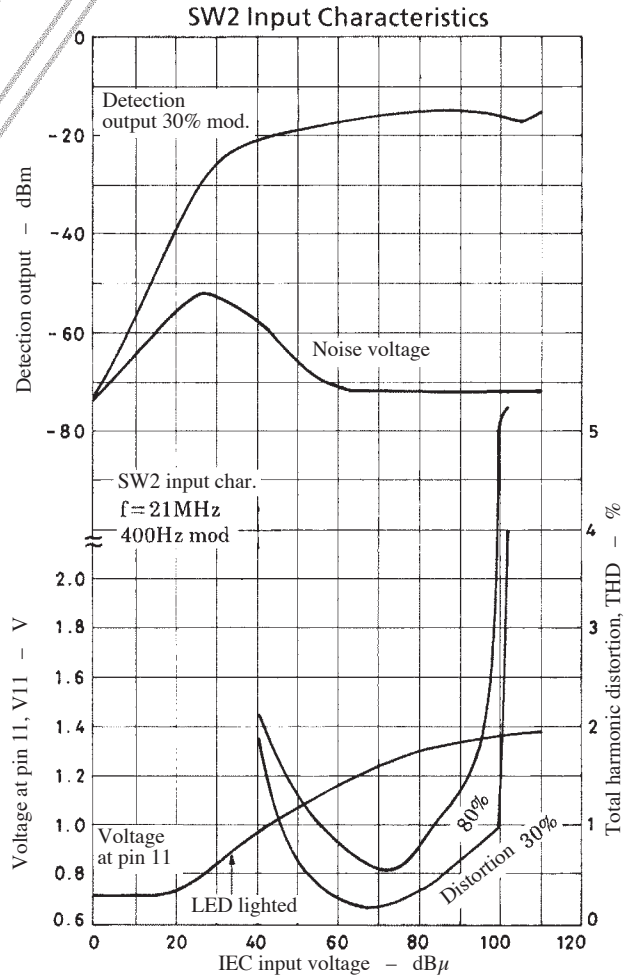
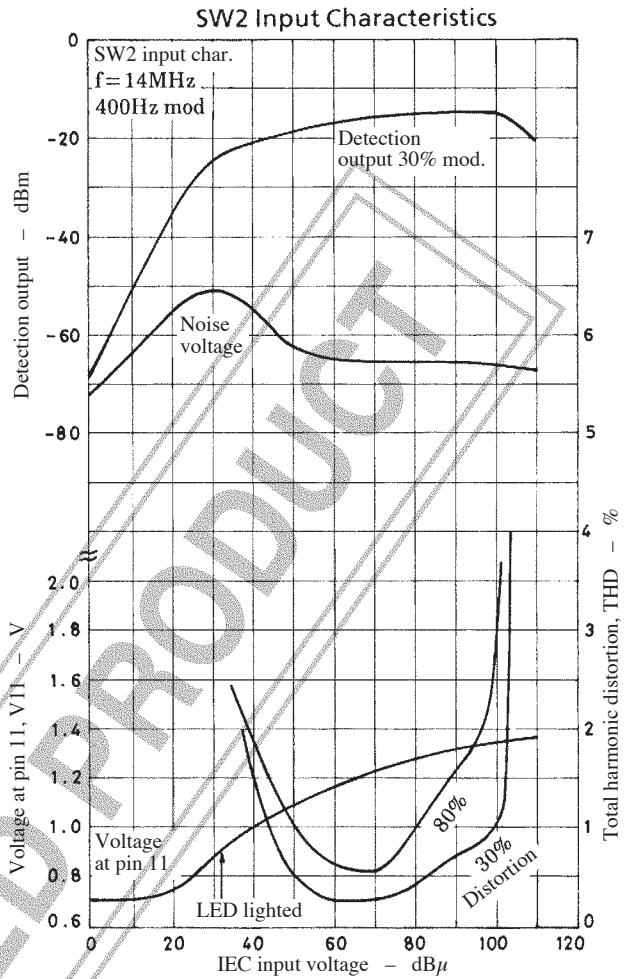
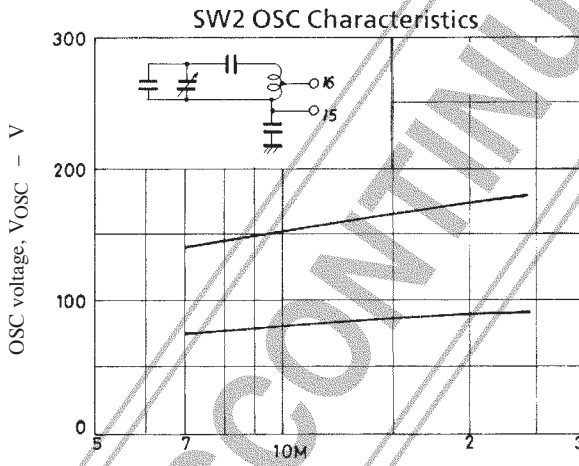
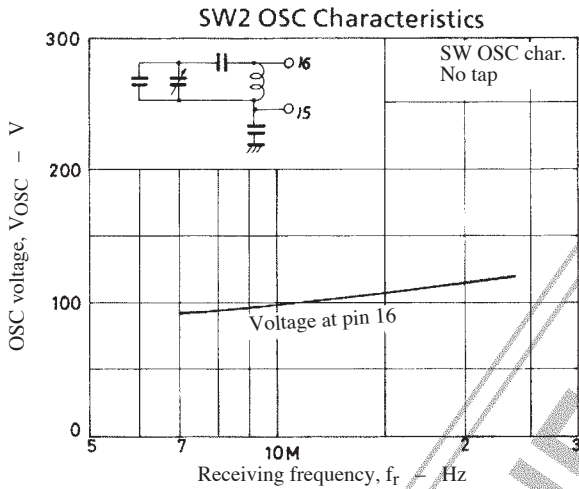
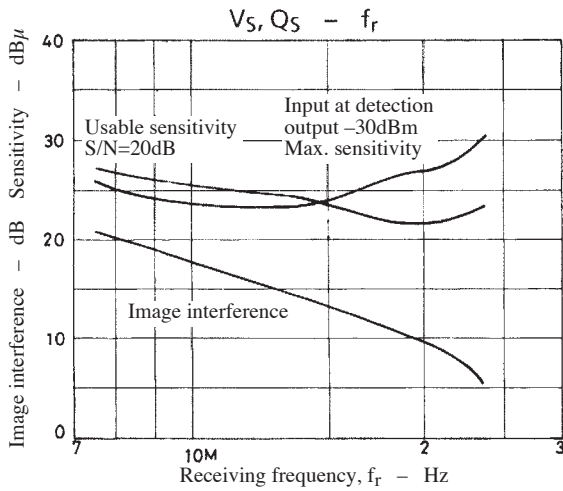

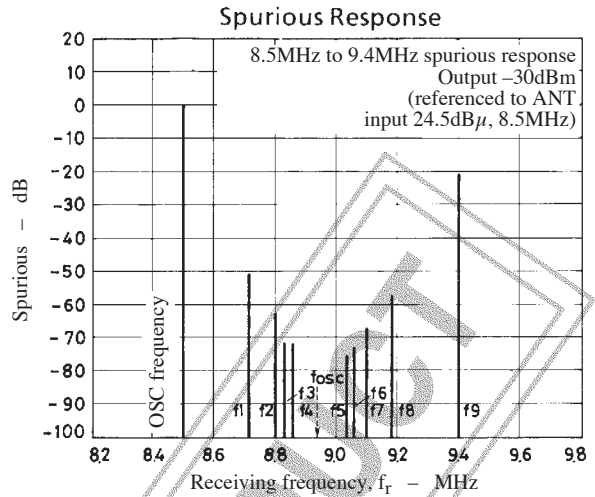
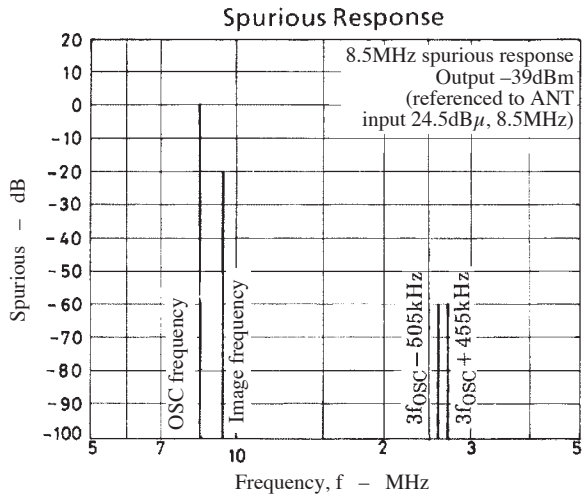

- f1 : 8.729MHz →  $2f_{OSC} - 2f_1 = 455\text{kHz}$
- f2 : 8.803MHz →  $3f_{OSC} - 3f_2 = 455\text{kHz}$
- f3 : 8.840MHz →  $4f_{OSC} - 4f_3 = 455\text{kHz}$
- f4 : 8.864MHz →  $5f_{OSC} - 5f_4 = 455\text{kHz}$
- f5 : 9.047MHz →  $5f_5 - 5f_{OSC} = 455\text{kHz}$
- f6 : 9.069MHz →  $4f_6 - 4f_{OSC} = 455\text{kHz}$
- f7 : 9.107MHz →  $3f_7 - 3f_{OSC} = 455\text{kHz}$
- f8 : 9.183MHz →  $2f_8 - 2f_{OSC} = 455\text{kHz}$

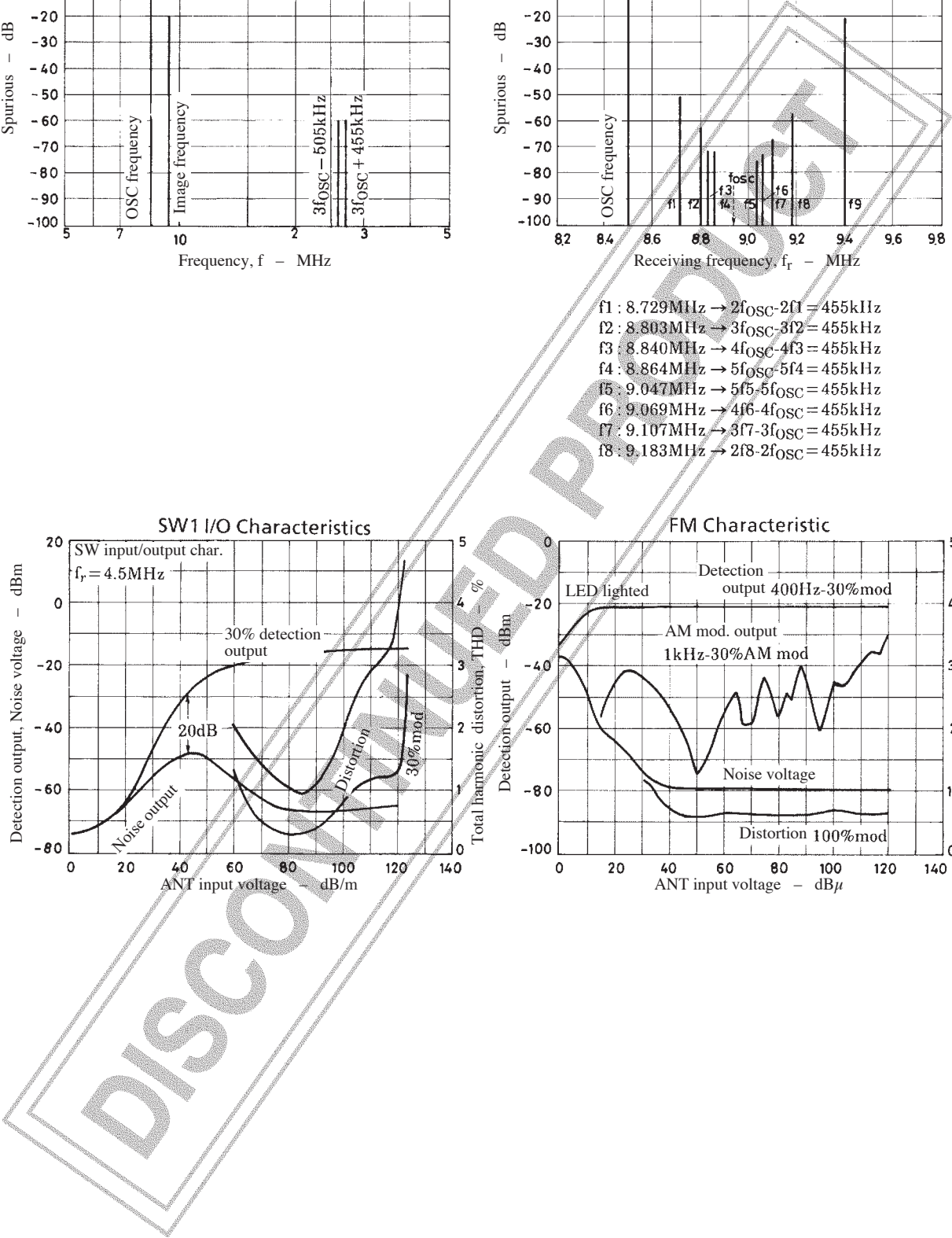
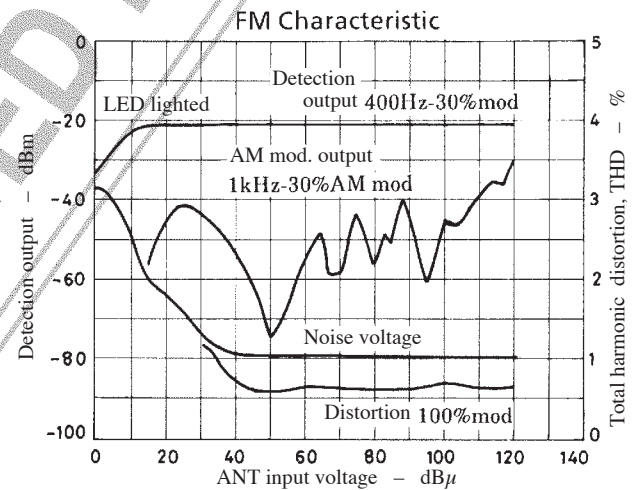
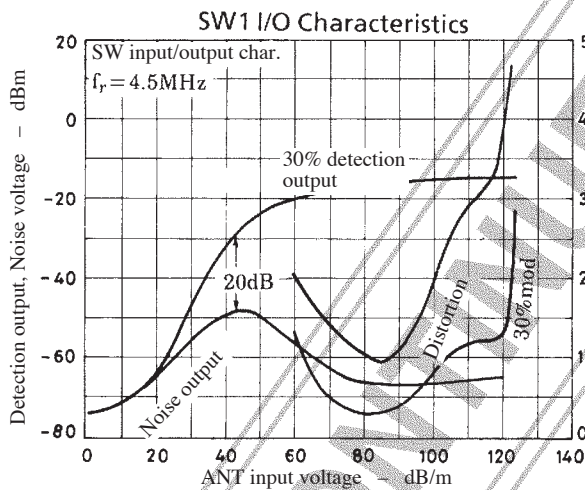

# LA1260

## Sample Application Circuit 2 : FM (band in US) /MW/SW1 (2.2 to 7.5MHz) /SW2 (7.2 to 24.0MHz)

Application where the LA1185 and LA1260 are used

[Circuit Diagram] (The sample printed circuit pattern is shown on page 13.)

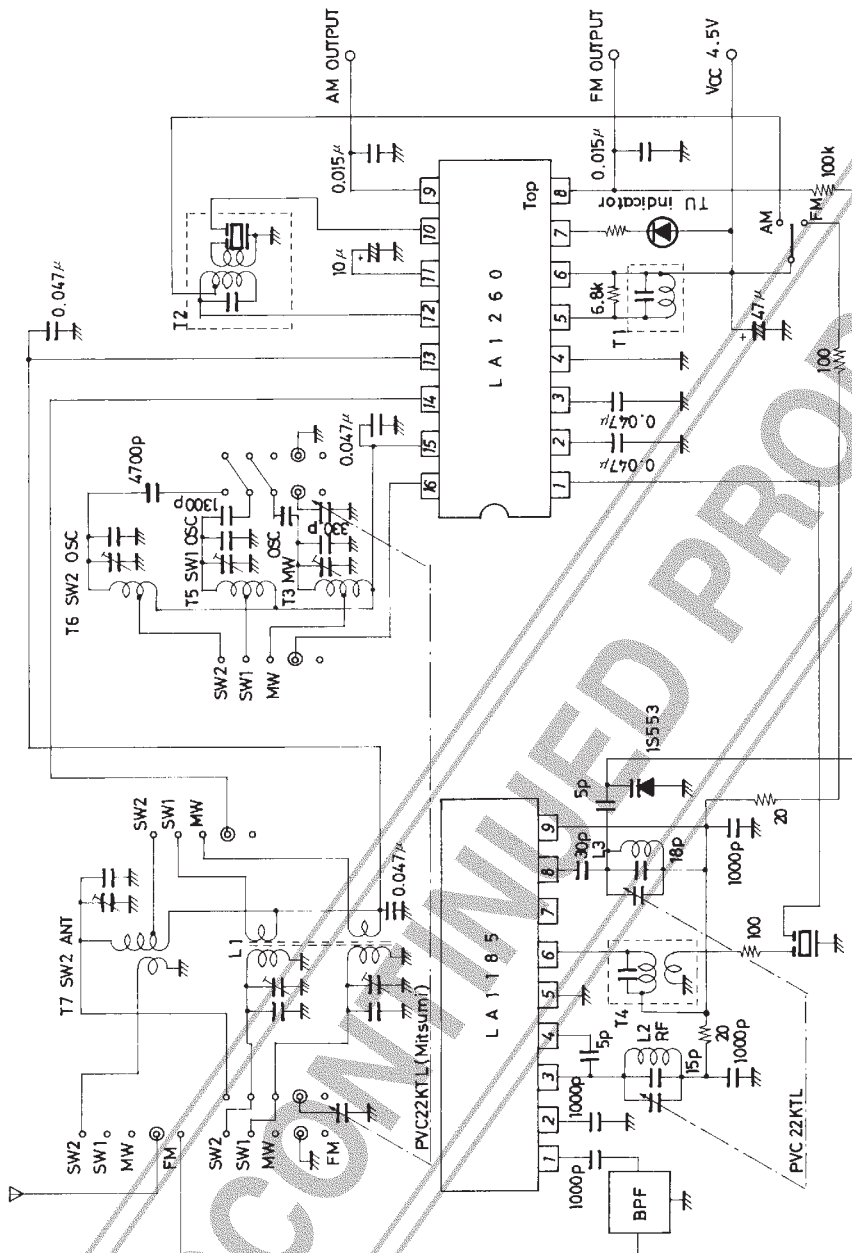

T4: YF-30224 (Mitsumi)  
FM IF

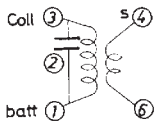

①-③ 8T, ④-⑥ 2T  
0.12mm 2UEW  
Internal 100pF, external 5pF  
 $f_0 = 10.7\text{MHz}$ ,  $Q_0 = 80$

- L1 TN10896 bar antenna (Mitsumi)
- T2 5.5mmφ air core 0.88mm wire 4T RF
- L3 5.5mmφ air core 0.88mm wire 3T OSC
- T1 YF-30194 (Mitsumi),  
2153-4095-339 (Sumida)
- T2 KW-30011 (AM Mix)
- T3 YF-30105 (Mitsumi)
- T4 YF-30224 (Mitsumi)
- T5 YF-30134 (Mitsumi)
- T6 YF-30112 (Mitsumi)
- T7 YF-30117 (Mitsumi)  
2158-4140-044 (Sumida)

Unit (resistance : Ω, capacitance : F)

Sample Printed Circuit Pattern : Cu-foiled area (The circuit diagram is shown on page 12.)

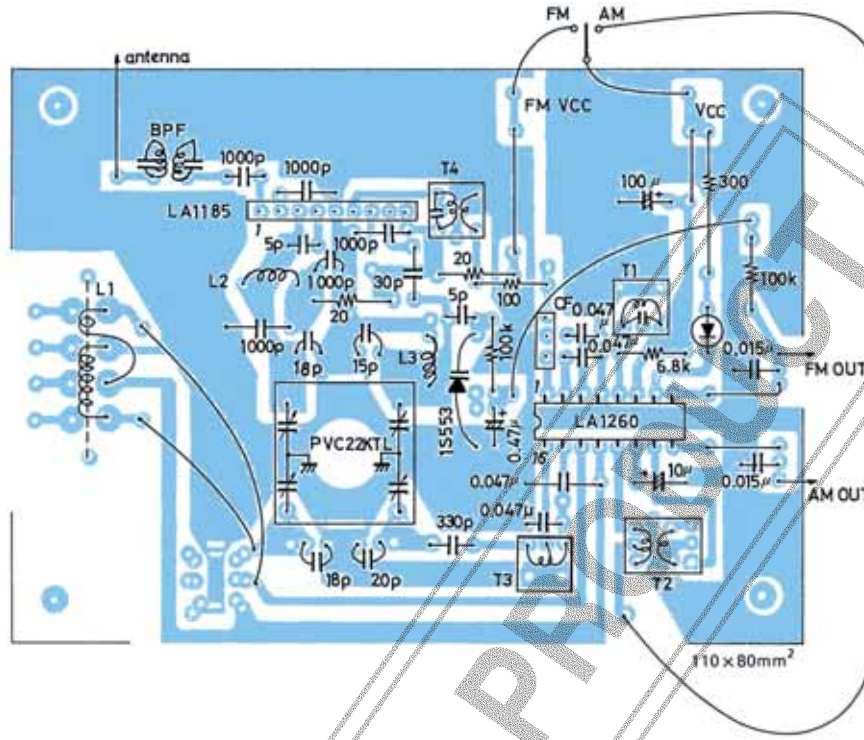

Unit (resistance : Ω, capacitance : F)

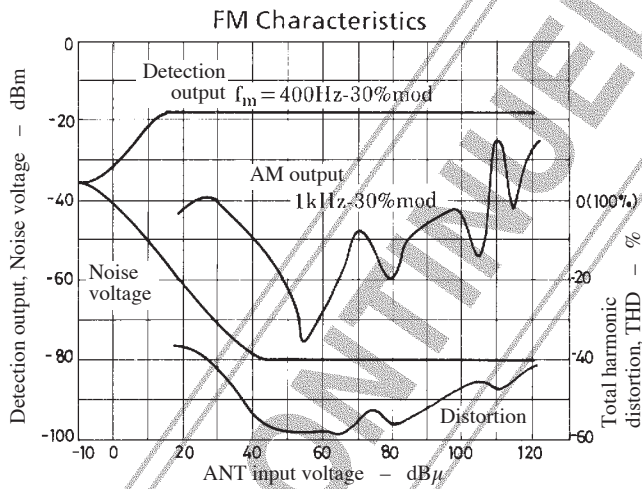

$f_r = 108\text{MHz}$   
 $V_{CC} = 4.5\text{V}$   
 $Q.S. = 9.5\text{dB}\mu$   
 $-3\text{dB L.S.} = 9\text{dB}\mu$   
 LED lighting sensitivity  $11.5\text{dB}\mu$

- Applications where a double tuning coil is used (See page 3.)

The use of the following coil improves the distortion approximately 0.1% at 100% modulation.

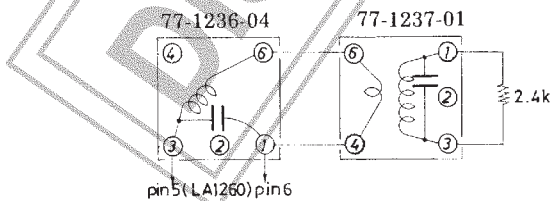

77-1236-04  
 (Korin Giken)  
 ③-⑥ 19.5T  
 ①-③ 68pF  
 $Q_0 = 78 \pm 20\%$   
 $0.08\phi$  2UEW

77-1237-01  
 (Korin Giken)  
 ①-③ 20T  
 ⑥-④ 1T  
 ①-③ 82pF  
 $Q_0 = 59 \pm 20\%$

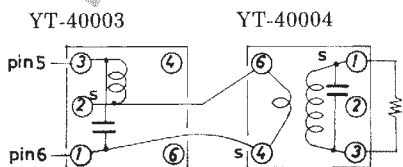

YT-40003  
 (Mitsumi)  
 ②-③ 25T  
 ①-③ 56pF  
 $Q_0 = 40 \pm 20\%$   
 $0.1\text{mm}\phi$  2UEW

YT-40004  
 (Mitsumi)  
 ④-⑥ 1T  
 ①-③ 23T 82pF  
 $Q_0 = 40 \pm 20\%$   
 $0.1\text{mm}\phi$  2UEW



■ No products described or contained herein are intended for use in surgical implants, life-support systems, aerospace equipment, nuclear power control systems, vehicles, disaster/crime-prevention equipment and the like, the failure of which may directly or indirectly cause injury, death or property loss.

■ Anyone purchasing any products described or contained herein for an above-mentioned use shall:

- ① Accept full responsibility and indemnify and defend SANYO ELECTRIC CO., LTD., its affiliates, subsidiaries and distributors and all their officers and employees, jointly and severally, against any and all claims and litigation and all damages, cost and expenses associated with such use:
- ② Not impose any responsibility for any fault or negligence which may be cited in any such claim or litigation on SANYO ELECTRIC CO., LTD., its affiliates, subsidiaries and distributors or any of their officers and employees jointly or severally.

■ Information (including circuit diagrams and circuit parameters) herein is for example only; it is not guaranteed for volume production. SANYO believes information herein is accurate and reliable, but no guarantees are made or implied regarding its use or any infringements of intellectual property rights or other rights of third parties.

This catalog provides information as of November, 1997. Specifications and information herein are subject to change without notice.

## X-ON Electronics

Largest Supplier of Electrical and Electronic Components

*Click to view similar products for [Tuners](#) category:*

*Click to view products by [ON Semiconductor](#) manufacturer:*

Other Similar products are found below :

[LV25700PM-MPB-E](#) [LA1773M-A-TLM-E](#) [LA1776M-MPB-E](#) [LA1781MD-B-MPB-E](#) [LA1837M-TLM-E](#) [TDA18215HN/C1Y](#) [TCC-106A-RT](#) [TCC-202A-RT](#) [LA1780MA-A-MPB-E](#) [MAX2172ETL+](#) [TCP-4127UB-DT](#) [MAX2112ETI+T](#) [LA1781ML-MPB-E](#) [TEF6635HW/V106K](#) [LV25810PEB-6156H](#) [TCC-206A-RT](#) [TCP-5033UB-DT](#) [TDA7786](#) [TDA7703TR](#) [LV23201T-TLM-E](#) [LA1867NM-MPB-E](#) [MAX2160ETL+](#) [MAX2135AETN](#) [MAX2112ETI+](#) [MAX2169ETL+](#) [MAX2121ETI+](#) [MAX2120CTI+](#) [MAX2112CTI+](#) [LV23014T-A-TLM-E](#) [MAX2135AETN/V+](#) [TDA18250BHN/C1K](#) [TDA18250HN/C1,557](#) [MAX2112ETI](#) [MAX2121ETI](#) [MAX2120CTI](#) [MAX2112CTI](#) [TDA18250AHN/C1,557](#) [TCP-5068UB-DT](#) [TCP-5082UB-DT](#) [TCP-5056UB-DT](#) [TCP-5018UB-DT](#) [CX24118A-12Z,557](#) [SI2141-B10-GM](#) [SI2151-A10-GMR](#) [MAX2223ETI+](#) [MAX2170ETL+](#) [MAX2171ETL+](#) [TDA18250BHNC1K](#) [TEF6606T/V5,518](#) [LV25200M-MPB-E](#)