



ON Semiconductor®

<http://onsemi.com>

LV47022P

Monolithic Linear IC

4-Channel BTL Power Amplifier for Car Audio Systems

Overview

The LV47022P is the IC for 4-channel BTL power amplifier that is developed for car audio system.

Pch DMOS in the upper side of the output stage and Nch DMOS in the lower side of the output stage are complimentary. High power and high quality sound are realized by that.

This IC incorporate various functions (standby switch, muting function, and various protection circuit) necessary for car audio system. Also, it has a self-diagnosis function.

Functions

- High output : P_O max = 48W (typical) ($V_{CC} = 15.2V$, $f = 1kHz$, $R_L = 4\Omega$, Max Power)
: P_O max = 28W (typical) ($V_{CC} = 14.4V$, $f = 1kHz$, THD = 10%, $R_L = 4\Omega$)
: P_O max = 21W (typical) ($V_{CC} = 14.4V$, $f = 1kHz$, THD = 1%, $R_L = 4\Omega$)
- Built-in muting function (pin 22)
- Built-in Standby switch (pin 4)
- Built-in Self-diagnosis function (pin 25) :
Signal output in case of output offset detection, shorting to V_{CC} , shorting to ground, load shorting and over voltage.
- Circuit that decrease of Electric mirror noise and GSM noise.
- Built-in various protection circuit (shorting to ground, shorting to V_{CC} , load shorting, over voltage and thermal shut down)

Note 1 : Please do not mistake connection.

A wrong connection may produce destruction, deterioration and damage for the IC or equipment.

Note 2 : The protective circuit function is provided to temporarily avoid abnormal state such as incorrect output connection. But, there is no guarantee that the IC is not destroyed by the accident.

The protective function do not operate of the operation guarantee range. If the outputs are connected incorrectly, IC destruction may occur when used outside of the operation guarantee range.

LV47022P

Specifications

Absolute Maximum Ratings at $T_a = 25^\circ\text{C}$

Parameter	Symbol	Conditions	Ratings	Unit
Maximum supply voltage	$V_{CC\ max1}$	No signal, $t = 1$ minute	26	V
	$V_{CC\ max2}$	During operations	18	V
Maximum output current	$I_{O\ peak}$	Per channel	4.5/ch	A
Allowable power dissipation	$P_d\ max$	With an infinity heat sink	50	W
Operating temperature	T_{opr}		-40 to +85	$^\circ\text{C}$
Storage temperature	T_{stg}		-40 to +150	$^\circ\text{C}$
Junction temperature	T_j		150	$^\circ\text{C}$
Thermal resistance between the junction and case	θ_{j-c}		1	$^\circ\text{C}/\text{W}$

Stresses exceeding Maximum Ratings may damage the device. Maximum Ratings are stress ratings only. Functional operation above the Recommended Operating Conditions is not implied. Extended exposure to stresses above the Recommended Operating Conditions may affect device reliability.

Recommended Operating Ranges at $T_a = 25^\circ\text{C}$

Parameter	Symbol	Conditions	Ratings	Unit
Recommended load resistance	$R_L\ op$		4	Ω
Operating supply voltage range	$V_{CC\ op}$	A range not exceeding P_{dmax}	8 to 16	V

Electrical Characteristics at $T_a = 25^\circ\text{C}$, $V_{CC} = 14.4\text{V}$, $R_L = 4\Omega$, $f = 1\text{kHz}$, $R_g = 600\Omega$

Parameter	Symbol	Conditions	Ratings			Unit
			Min.	Typ.	Max.	
Quiescent current	I_{CCO}	$R_L = \infty$, $R_g = 0\Omega$		200	400	mA
Standby current	I_{st}	$V_{st} = 0\text{V}$			3	μA
Voltage gain	VG	$V_O = 0\text{dBm}$	25	26	27	dB
Voltage gain difference	ΔVG		-1		+1	dB
Output power	P_O	THD = 10%	23	28		W
	$P_O\ max1$	Max Power		43		W
	$P_O\ max2$	$V_{CC} = 15.2$, Max Power		48		W
Output offset voltage	$V_n\ offset$	$R_g = 0\Omega$	-100		+100	mV
Total harmonic distortion	THD	$P_O = 4\text{W}$		0.02	0.10	%
Channel separation	CHsep	$V_O = 0\text{dBm}$, $R_g = 10\text{k}\Omega$	55	65		dB
Ripple rejection ratio	SVRR	$R_g = 0\Omega$, $f_r = 100\text{Hz}$, $V_{CC}R = 0\text{dBm}$	50	65		dB
Output noise voltage	V_{NO}	$R_g = 0\Omega$, B.P.F. = 20Hz to 20kHz		60	120	μVrms
Input resistance	R_i		80	100	120	$\text{k}\Omega$
Mute attenuation	Matt	$V_O = 20\text{dBm}$, mute : on	80	90		dB
Standby pin control voltage	$V_{stby\ H}$	Amp : on	2.5		V_{CC}	V
	$V_{stby\ L}$	Amp : off	0.0		0.5	V
Mute pin control voltage	$V_{mute\ H}$	Mute : off	2.9		6.0	V
	$V_{mute\ L}$	Mute : on	0.0		1.0	V
Output offset detection						
Detection threshold voltage	Vosdet		± 1.2	± 1.8	± 2.4	V

* 0dBm = 0.775Vrms

LV47022P

Package Dimensions

unit : mm (typ)
3236A

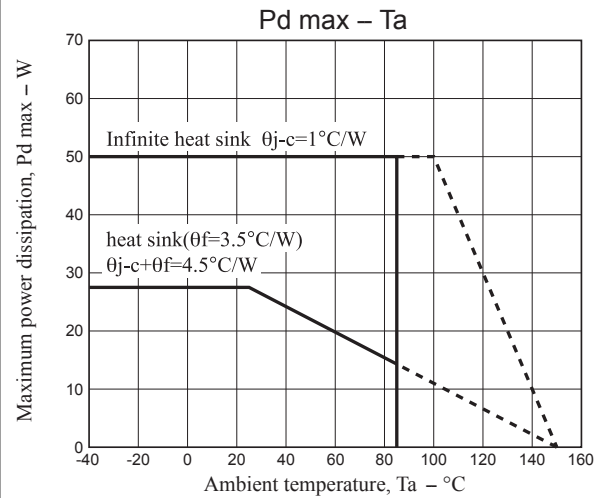
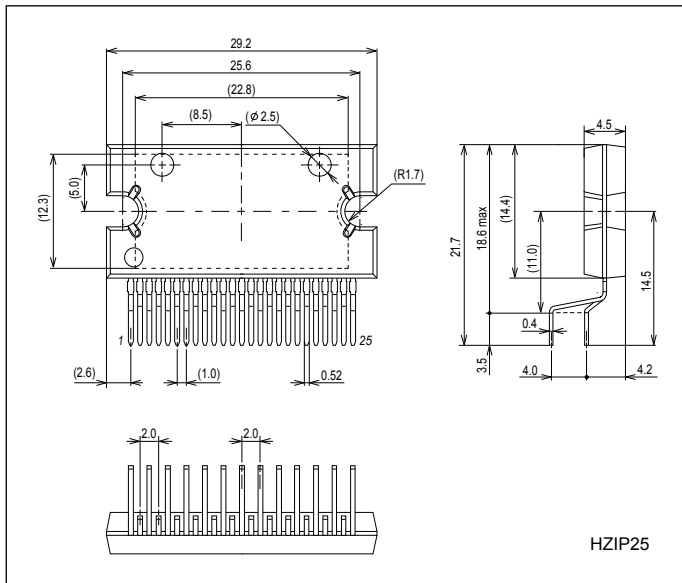

External Components

Part Name	Recommended Value	Purpose	Remarks
C1 to C4	0.22 μF	Cuts DC voltage	The larger the constant value, the lower the cut-off frequency. When AMP ON, bigger value worse pop noise. The values of C1 to C4 must be the same. C1 to C4 must use capacitor of low leak current.
C5	1 μF	Cuts DC voltage	The ratio of the input capacitance (C1 to C4) to the ACGND capacitance (C5) should be 1:4. If the ratio deviates, pop noise and SVRR are worse. Use capacitor same as C1 to C4.
C6	22 μF	Reduces pop noise (AMP ON/OFF) Reduces ripples	The larger the constant value, the longer the amplifier ON/OFF time. The larger the constant value, SVRR is good. On the other hand, the smaller constant value. AMP ON/OFF will be shorter.
C7	2200 μF	Ripple filter	Eliminating power supply ripples. Please put near IC.
C8	0.1 μF	Improves oscillation stability	Reducing high-frequency noise. Please put near IC.
C9	1 μF	Reduces pop noise (Mute ON \leftrightarrow OFF)	The larger the constant value, pop noise is small. The large the constant value, the longer the mute ON/OFF time. On the other hand, the smaller constant value. Mute ON/OFF will be shorter. And, Mute ON \leftrightarrow OFF pop noise will be worse.
R1	47k Ω		
R2	4.7k Ω	Pull-up resistor	Because of transistor ability in IC, Please use 2.2k Ω or more.

* The components and constant values within the test circuit are used for confirmation of characteristics and are not guarantees that incorrect or trouble will not occur in application equipment.

LV47022P

4. Self-diagnostics function (Pin 25)

In four modes to write below, the signal is output to the Pin 25.

Also, by controlling the standby switch after the signal of the Pin 25 is detected by the microcomputer, the burnout of the speaker can be prevented.

- (1) Shorting to V_{CC} /Shorting to ground : The Pin 25 becomes the low level.
- (2) Load shorting : The Pin 25 is alternated between the low level and the high level according to the output signal.
- (3) Over voltage : When the voltage of V_{CC} exceeds voltage 21V (typical), the Pin 25 becomes the low level.
- (4) Output offset detection : When the output offset voltage exceeds the detection threshold voltage, the Pin 25 becomes the low level.

In addition, the Pin 25 has become the NPN open collector output (active low).

The Pin 25 must be left open when this function is not used.

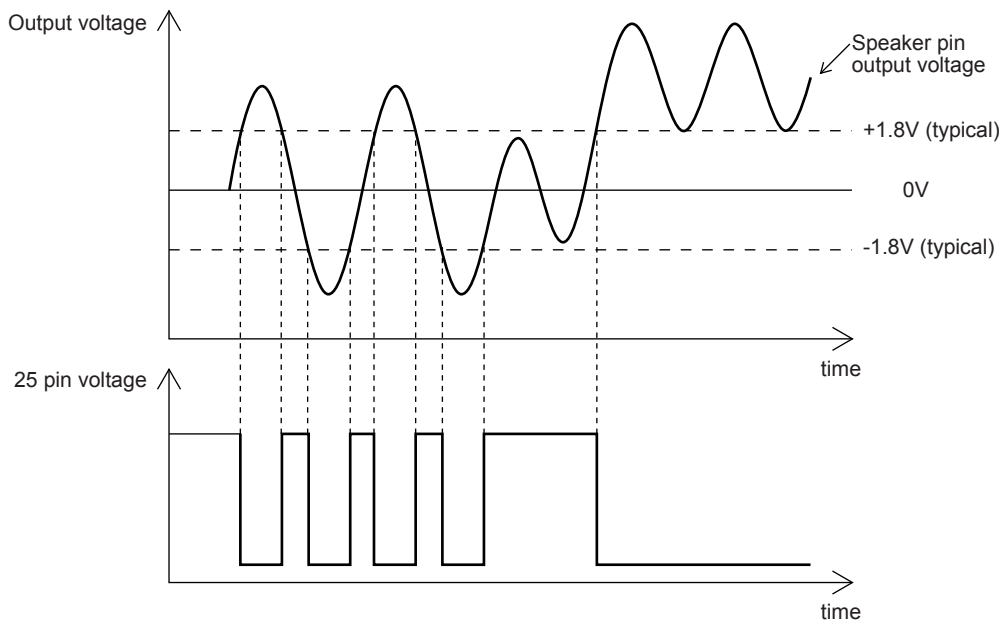

Fig3 Offset detection

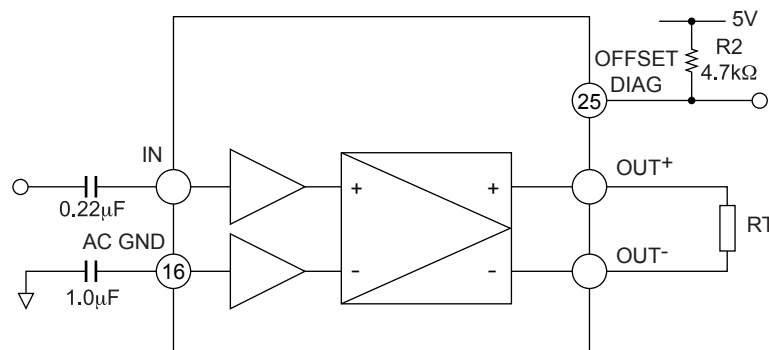

Fig4 Operating Pin 25

5. Sound quality (low frequencies)

By varying the value of input capacitor, low-frequency characteristic can be improved.
However, it is concerned the pop noise. Please confirm in each set when the capacitance value varies.

6. Pop noise

For pop noise prevention, it is recommended to use the muting function at the same time.

At AMP ON

Set MUTE ON first, then set STBY pin High (AMP ON).

About 1.5sec later, set to be MUTE OFF.

At AMP OFF

After 10msec later MUTE ON, please do STBY pin Low (AMP OFF).

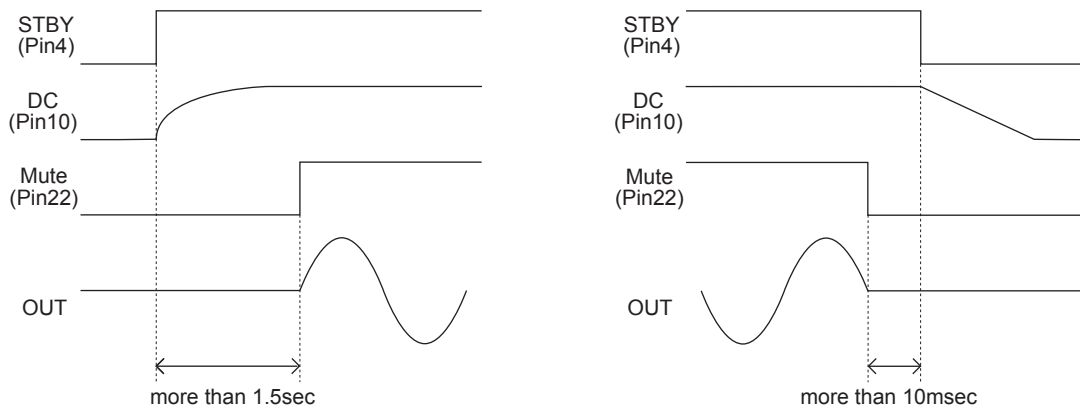

7. Oscillation stability

Pay due attention on the following points because parasitic oscillation may occur due to effects of the board layout, etc.

Board layout

- Provide the V_{CC} capacitor of $0.1\mu\text{F}$ in the position nearest to IC.
- PREGND must be independently wired and connected to the GND point that is as stable as possible, such as the minus pin of the $2200\mu\text{F}$ V_{CC} capacitor.

In case of occurrence of parasitic oscillation, any one of following parts may be added as a countermeasure.

Please check your capacitor of optimal value at set

- Series connection of CR ($0.1\mu\text{F}$ and 2.2Ω) between each output pin and GND.

8. EMC countermeasure

LV47022P has function that decrease of Electric mirror noise and GSM noise.

When you connect capacitor of more than 1000pF between out and GND because of EMC countermeasure, please add oscillation cut parts. Value of oscillation prevention parts recommends $2.2\Omega + 0.1\mu\text{F}$.

LV47022P

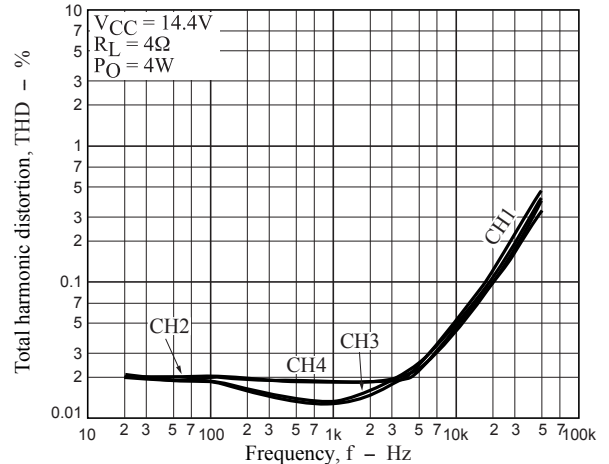
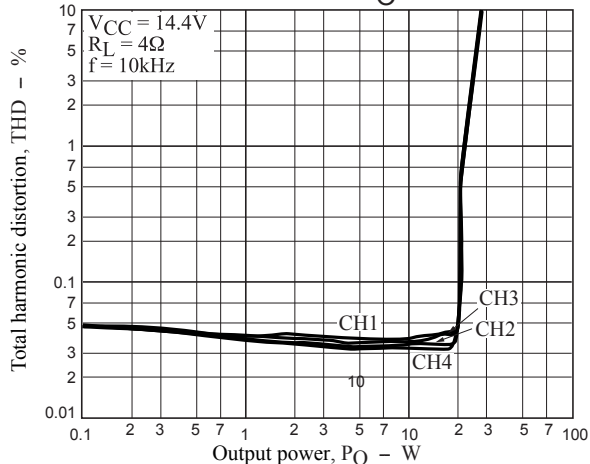
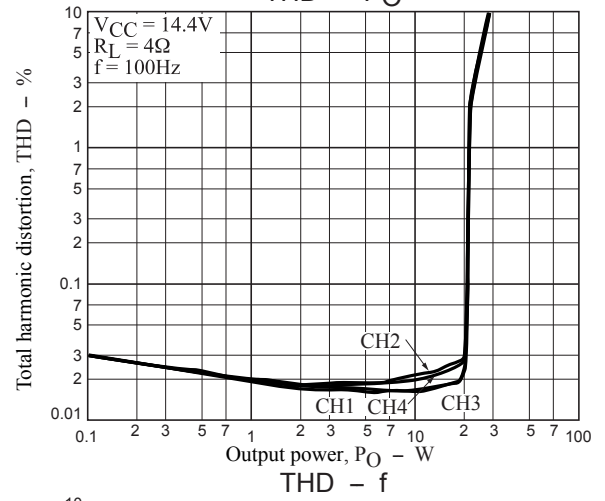
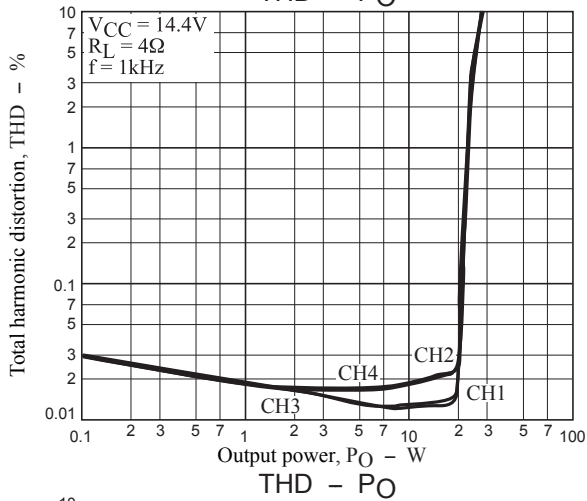
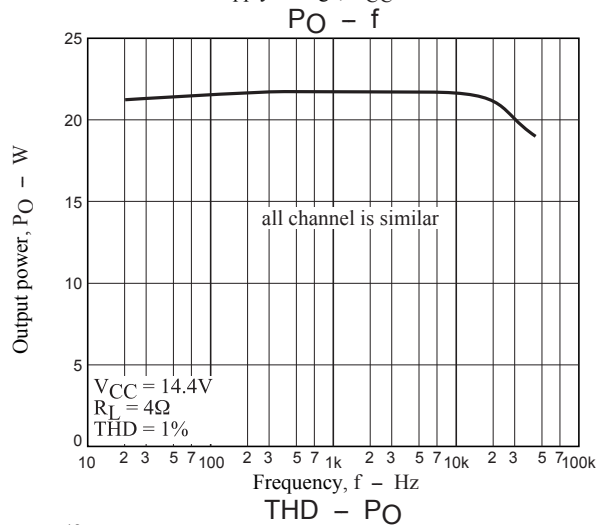
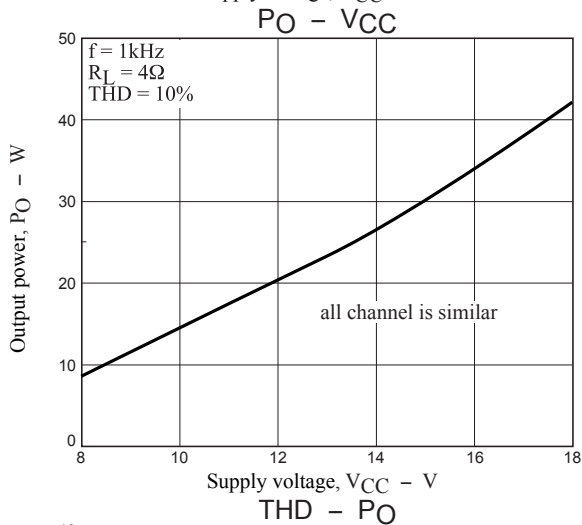
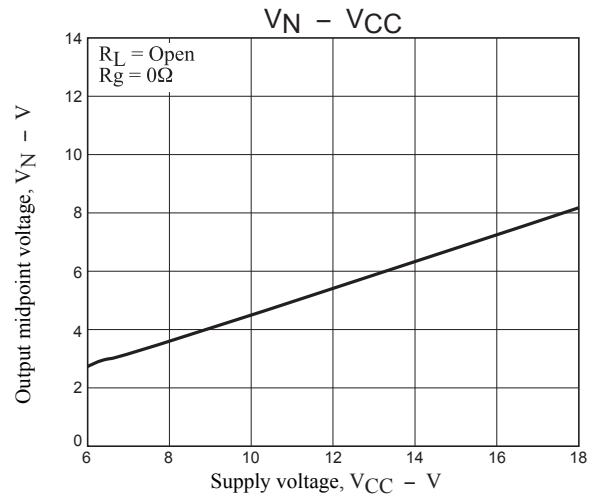
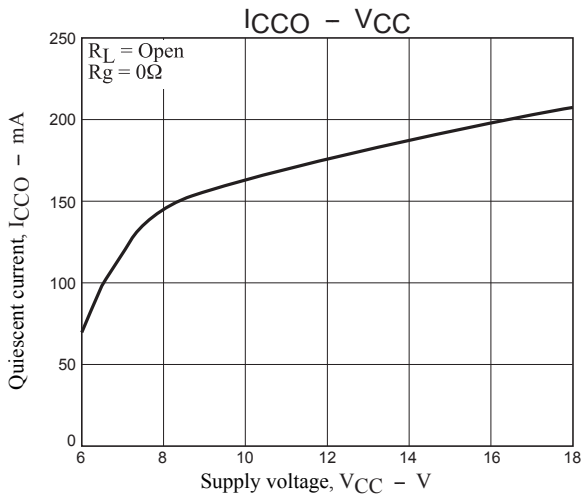

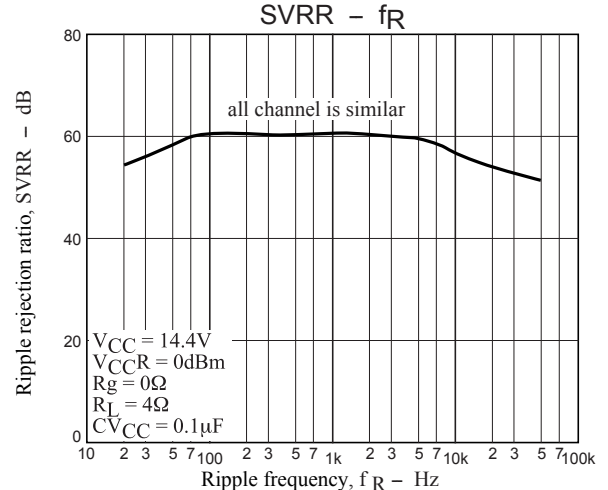
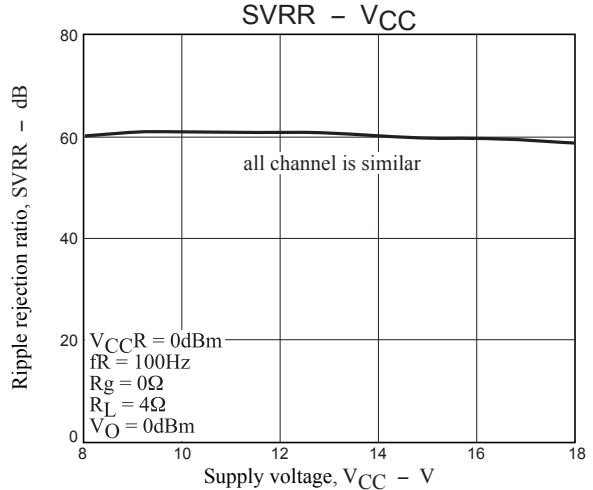
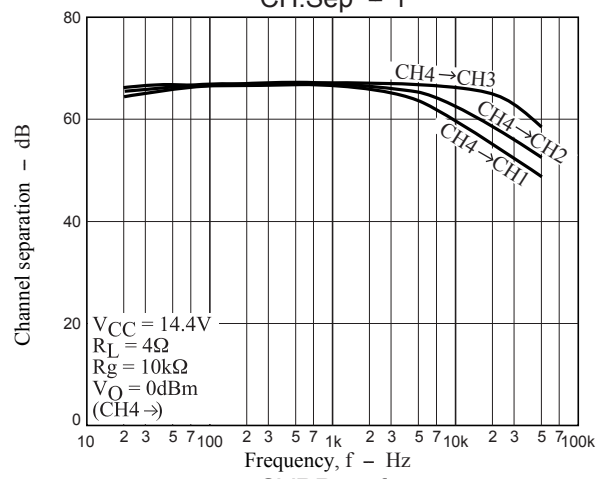
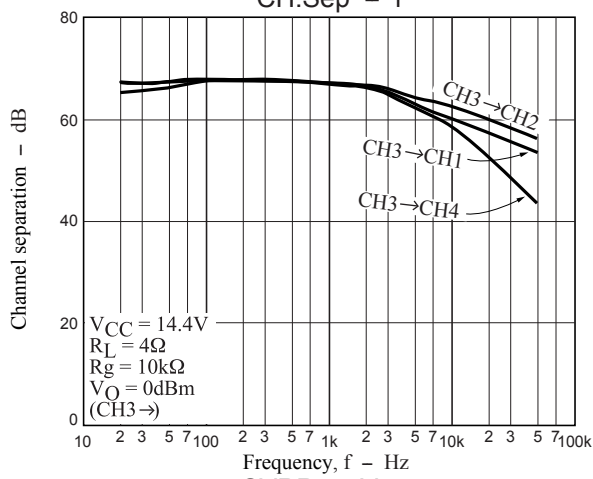
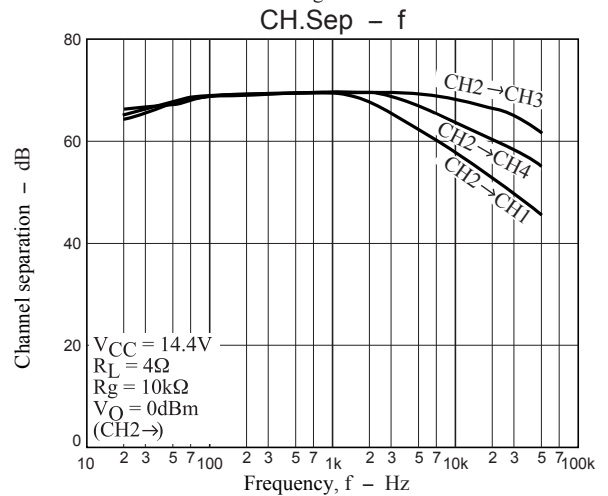
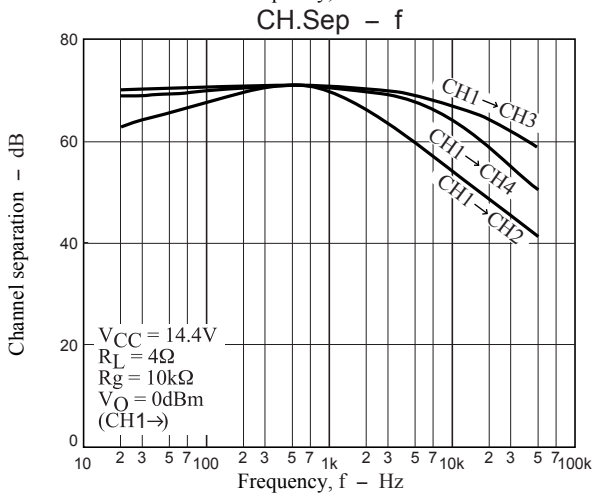
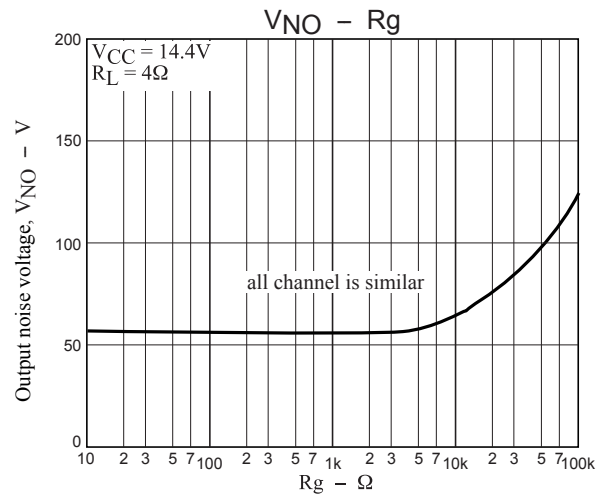
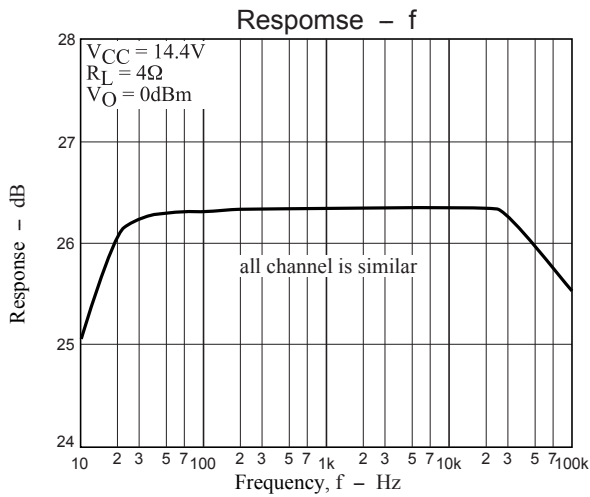

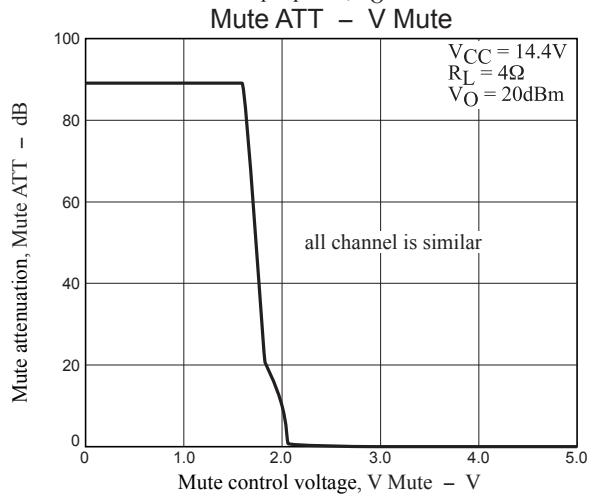
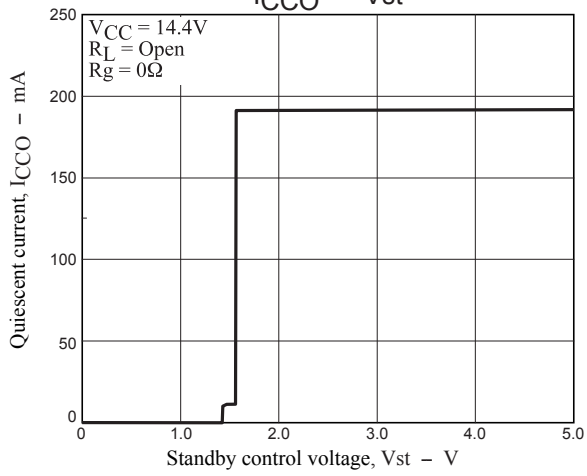
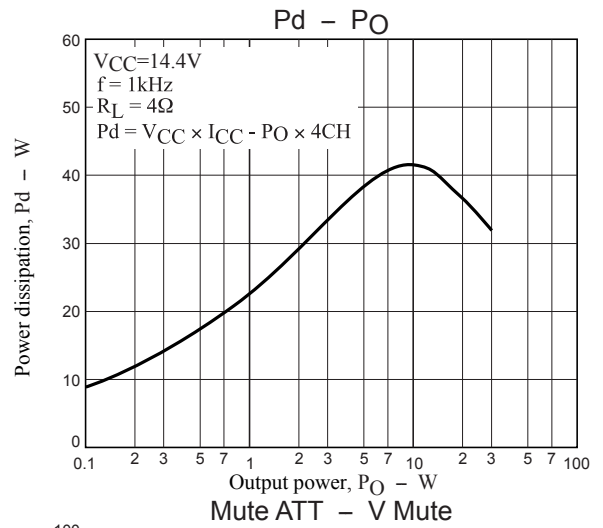
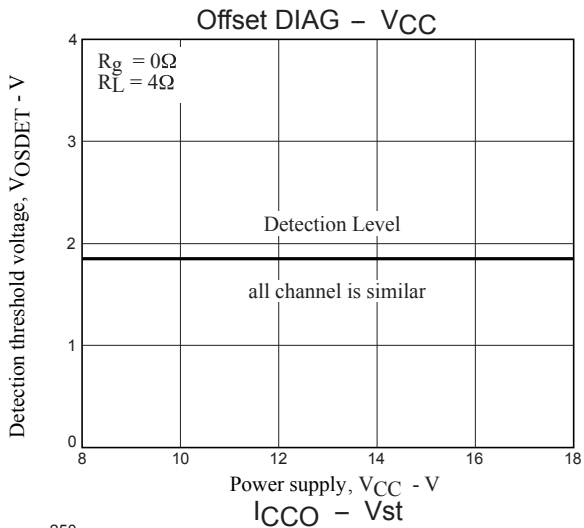

HZIP25 Heat sink attachment

Heat sinks are used to lower the semiconductor device junction temperature by leading the heat generated by the device to the outer environment and dissipating that heat.

- a. Unless otherwise specified, for power ICs with tabs and power ICs with attached heat sinks, solder must not be applied to the heat sink or tabs.

b. Heat sink attachment

- Use flat-head screws to attach heat sinks.
- Use also washer to protect the package.
- Use tightening torques in the ranges 39-59Ncm(4-6kgcm) .
- If tapping screws are used, do not use screws with a diameter larger than the holes in the semiconductor device itself.
- Do not make gap, dust, or other contaminants to get between the semiconductor device and the tab or heat sink.
- Take care a position of via hole .
- Do not allow dirt, dust, or other contaminants to get between the semiconductor device and the tab or heat sink.
- Verify that there are no press burrs or screw-hole burrs on the heat sink.
- Warping in heat sinks and printed circuit boards must be no more than 0.05 mm between screw holes, for either concave or convex warping.
- Twisting must be limited to under 0.05 mm.
- Heat sink and semiconductor device are mounted in parallel.
Take care of electric or compressed air drivers
- The speed of these torque wrenches should never exceed 700 rpm, and should typically be about 400 rpm.

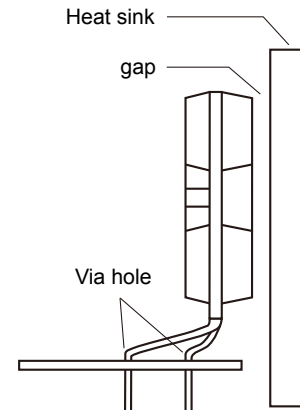
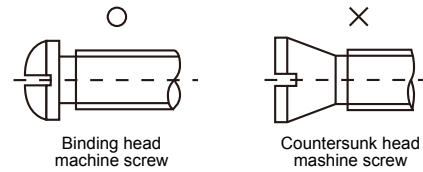

c. Silicone grease

- Spread the silicone grease evenly when mounting heat sinks.
- Our company recommends YG-6260 (Momentive Performance Materials Japan LLC)

d. Mount

- First mount the heat sink on the semiconductor device, and then mount that assembly on the printed circuit board.
- When attaching a heat sink after mounting a semiconductor device into the printed circuit board, when tightening up a heat sink with the screw, the mechanical stress which is impossible to the semiconductor device and the pin doesn't hang.

e. When mounting the semiconductor device to the heat sink using jigs, etc.,

- Take care not to allow the device to ride onto the jig or positioning dowel.
- Design the jig so that no unreasonable mechanical stress is not applied to the semiconductor device.

f. Heat sink screw holes

- Be sure that chamfering and shear drop of heat sinks must not be larger than the diameter of screw head used.
- When using nuts, do not make the heat sink hole diameters larger than the diameter of the head of the screws used. A hole diameter about 15% larger than the diameter of the screw is desirable.
- When tap screws are used, be sure that the diameter of the holes in the heat sink are not too small. A diameter about 15% smaller than the diameter of the screw is desirable.

- g. There is a method to mount the semiconductor device to the heat sink by using a spring band. But this method is not recommended because of possible displacement due to fluctuation of the spring force with time or vibration.

ON Semiconductor and the ON logo are registered trademarks of Semiconductor Components Industries, LLC (SCILLC). SCILLC owns the rights to a number of patents, trademarks, copyrights, trade secrets, and other intellectual property. A listing of SCILLC's product/patent coverage may be accessed at www.onsemi.com/site/pdf/Patent-Marking.pdf. SCILLC reserves the right to make changes without further notice to any products herein. SCILLC makes no warranty, representation or guarantee regarding the suitability of its products for any particular purpose, nor does SCILLC assume any liability arising out of the application or use of any product or circuit, and specifically disclaims any and all liability, including without limitation special, consequential or incidental damages. "Typical" parameters which may be provided in SCILLC data sheets and/or specifications can and do vary in different applications and actual performance may vary over time. All operating parameters, including "Typicals" must be validated for each customer application by customer's technical experts. SCILLC does not convey any license under its patent rights nor the rights of others. SCILLC products are not designed, intended, or authorized for use as components in systems intended for surgical implant into the body, or other applications intended to support or sustain life, or for any other application in which the failure of the SCILLC product could create a situation where personal injury or death may occur. Should Buyer purchase or use SCILLC products for any such unintended or unauthorized application, Buyer shall indemnify and hold SCILLC and its officers, employees, subsidiaries, affiliates, and distributors harmless against all claims, costs, damages, and expenses, and reasonable attorney fees arising out of, directly or indirectly, any claim of personal injury or death associated with such unintended or unauthorized use, even if such claim alleges that SCILLC was negligent regarding the design or manufacture of the part. SCILLC is an Equal Opportunity/Affirmative Action Employer. This literature is subject to all applicable copyright laws and is not for resale in any manner.

X-ON Electronics

Largest Supplier of Electrical and Electronic Components

Click to view similar products for [Audio Amplifiers](#) category:

Click to view products by [ON Semiconductor](#) manufacturer:

Other Similar products are found below :

[LV47002P-E](#) [NCP2811AFCT1G](#) [NCP2890AFCT2G](#) [SSM2377ACBZ-R7](#) [IS31AP4915A-QFLS2-TR](#) [NCP2820FCT2G](#) [TDA1591T](#)
[TDA7563AH](#) [SSM2529ACBZ-R7](#) [MAX9890AETA+T](#) [TS2012EIJT](#) [NCP2809BMUTXG](#) [NJW1157BFC2](#) [SSM2375CBZ-REEL7](#)
[IS31AP4996-GRLS2-TR](#) [STPA002OD-4WX](#) [NCP2823BFCT1G](#) [MAX9717DETA+T](#) [MAX9717CETA+T](#) [MAX9724AEBC+TG45](#)
[LA4450L-E](#) [IS31AP2036A-CLS2-TR](#) [MAX9723DEBE+T](#) [TDA7563ASMTR](#) [AS3561-DWLT](#) [SSM2517CBZ-R7](#) [MP1720DH-12-LF-P](#)
[SABRE9601K](#) [THAT1646W16-U](#) [MAX98396EWB+](#) [PAM8965ZLA40-13](#) [BD37532FV-E2](#) [BD5638NUX-TR](#) [BD37512FS-E2](#) [BD37543FS-](#)
[E2](#) [BD3814FV-E2](#) [TPA3140D2PWPR](#) [TS2007EIJT](#) [IS31AP2005-DLS2-TR](#) [SSM2518CPZ-R7](#) [AS3410-EQFP-500](#) [FDA4100LV](#)
[MAX98306ETD+T](#) [TS4994EIJT](#) [NCP2820FCT1G](#) [NCP2823AFCT2G](#) [NCS2211MNTXG](#) [CPA2233CQ16-A1](#) [OPA1604AIPWR](#)
[OPA1612AQDRQ1](#)