

# Test Procedure for the LV5011MD2GEVB Evaluation Board

## 1. Test Setup

### 1.1 Test Equipment

- Voltage Source: 230V<sub>AC</sub> AC source, NF EPO2000S
- Power Meter: HIOKI 3332
- Volt Meter: ADVANTEST R6441D DIGITAL MULTIMETER
- AMP Meter: Agilent DIGITAL MULTIMETER 34401A
- Output Load: 5 LEDs series (LED: OSW4Z3E1C1E)
- Oscilloscope: LeCroy WaveRunner 6050A
- Operating Temperature: 25°C

### 1.2 Recommended Test Setup

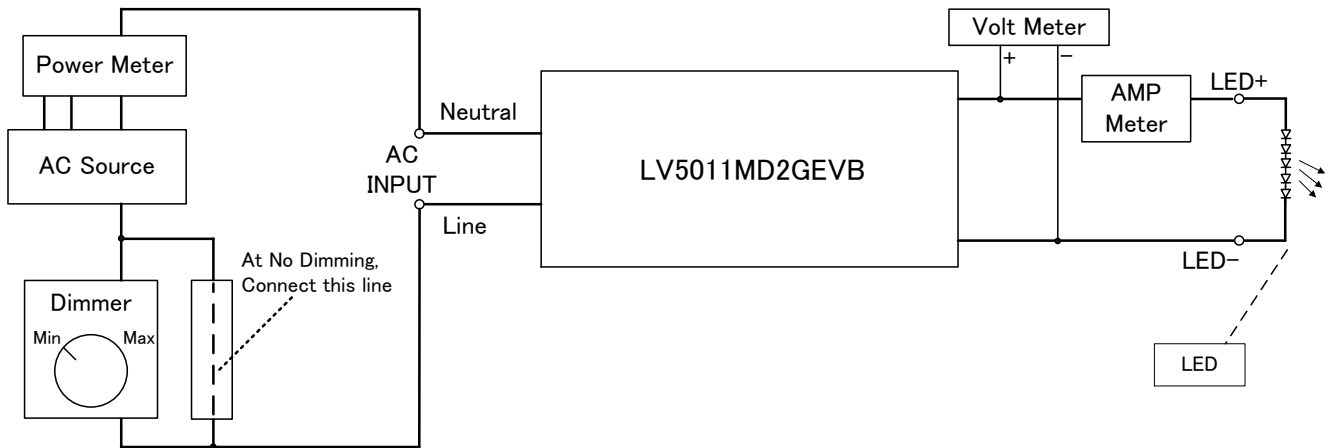

**Figure1.** LV5011MD2GEVB Recommended Test Set Up

### 1.3 List of Test Points

**Table1.** Test Points Functions

TEST POINTS NAME	DESCRIPTION
Neutral	230V <sub>AC</sub> neutral connection
Line	230V <sub>AC</sub> line voltage
LED+	LED anode connection
LED-	LED cathode connection



## **2. Test Procedure**

### **2.1 Line/Load Regulation and Efficiency Measurement Procedure**

1. Connect LV5011MD2GEVB like upper Figure1. An external LED load must be used to start up the EVB.
2. Prior to turning on the AC source, set the voltage to 230V<sub>AC</sub>.
3. Turn on the AC Source.
4. Record the output voltage readings from Volt Meter and the output current reading from AMP Meter. And Record the input power reading from Power Meter.
5. Change V<sub>AC</sub> from 198V<sub>AC</sub> to 264V<sub>AC</sub> and perform "4".
6. Refer to Section 2.2 for shutdown procedure.

### **2.2 Equipment Shutdown**

1. Turn off equipment.
2. Make sure capacitors are discharged.

### **2.3 Phase Angle Decode vs LED Current (at dimming)**

1. Connect LV5011MD2GEVB like upper Figure1. An external LED load must be used to start up the EVB.
2. Prior to turning on the AC source, set the voltage to 230V<sub>AC</sub>.
3. Monitor the Dimmer output AC voltage between the neutral and the line by using the oscilloscope differential probe.
4. Turn on the AC Source.
5. Maximize the dimmer ratio.
6. Record the output voltage readings from Volt Meter and the output current reading from AMP Meter. And Record the input power reading from Power Meter. And Record the phase angle of Dimmer output reading from the oscilloscope differential probe.
7. Gradually lower the Dimming ratio and perform "6". Repeat it until the Dimming ratio is minimized.
8. Refer to Section 2.2 for shutdown procedure.

### 3. Performance Data

#### 3.1 Efficiency

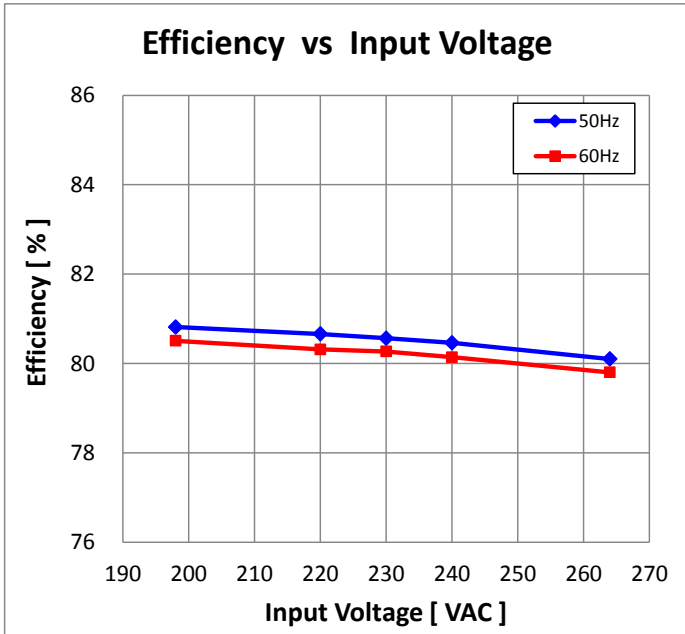

Figure2. Efficiency vs Input voltage

#### 3.2 Power factor

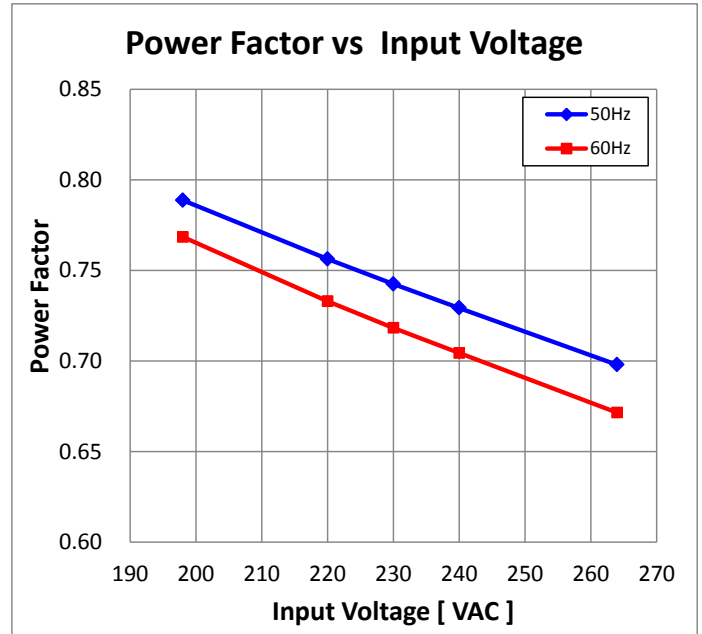

Figure3. Power factor vs Input voltage

#### 3.3 LED Current (Output current)

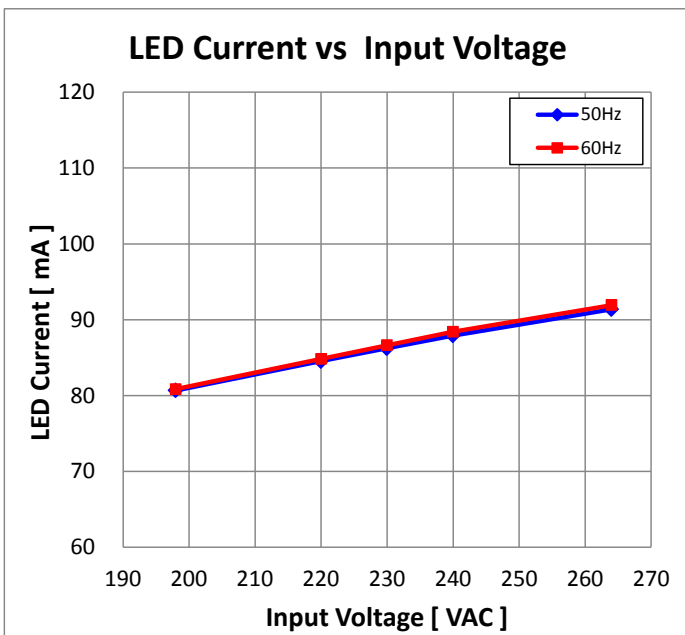

Figure4. LED current vs Input voltage

#### 3.4 Output Voltage

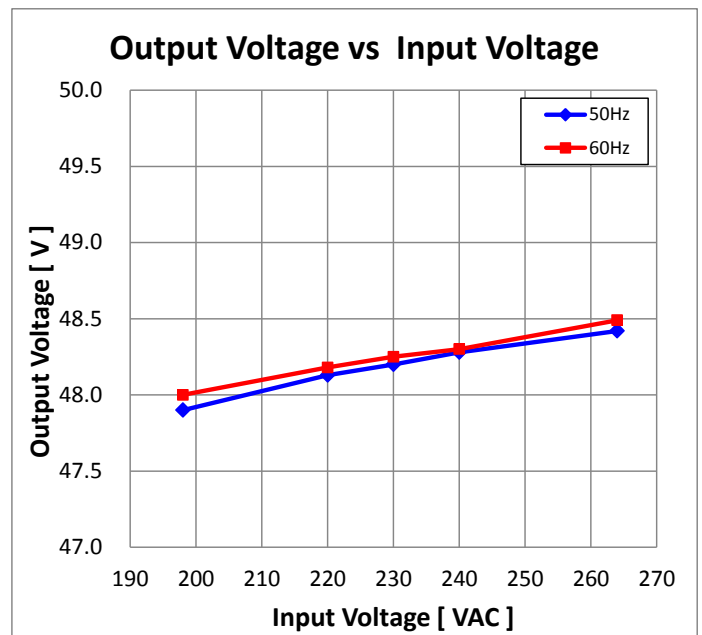

Figure5. Output voltage vs Input voltage

### 3.5 Input voltage/current operation waveform (No dimming)

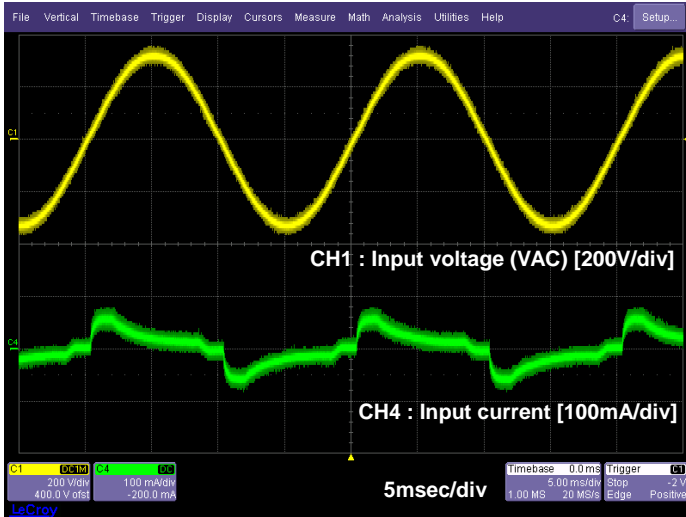

Figure6. Input waveform

### 3.6 Output voltage/current operation Waveform (No dimming)

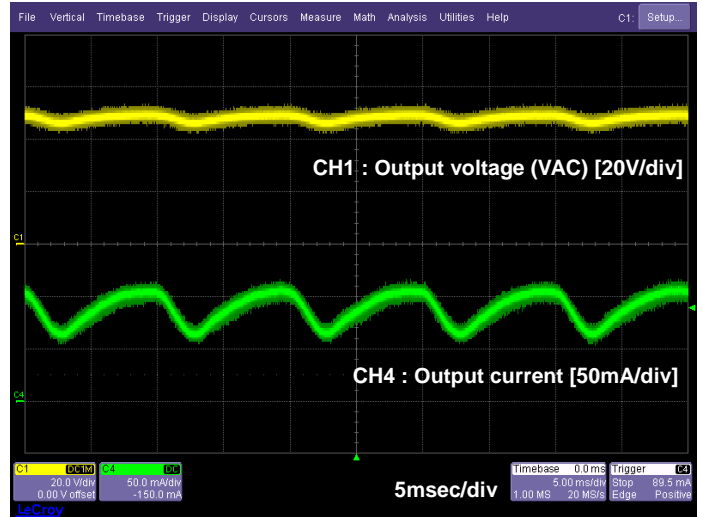

Figure7. Output waveform

### 3.7 LED Current vs Phase angle

[ V<sub>VAC</sub>=230V, 50Hz, Dimmer : MERTEN 572599 ]

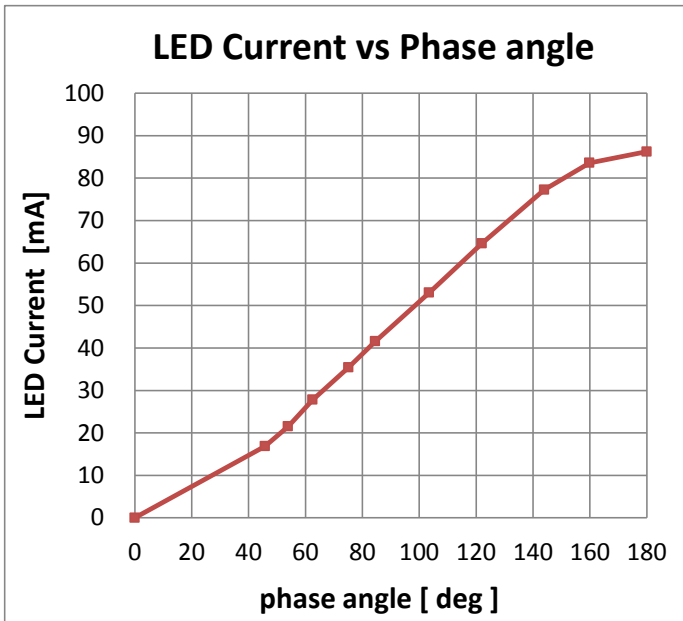
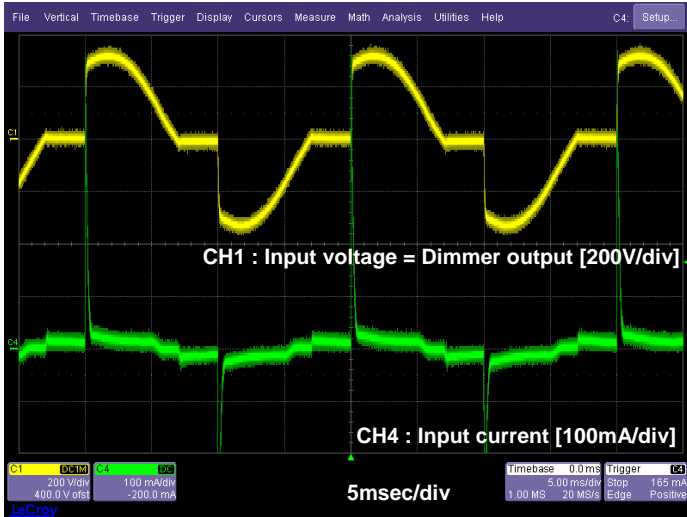

Figure8. LED current vs Phase angle

### 3.8 Dimming operation waveform

Phase angle = 120 degree

[ VAC=230V, 50Hz, Dimmer : MERTEN 572599 ]

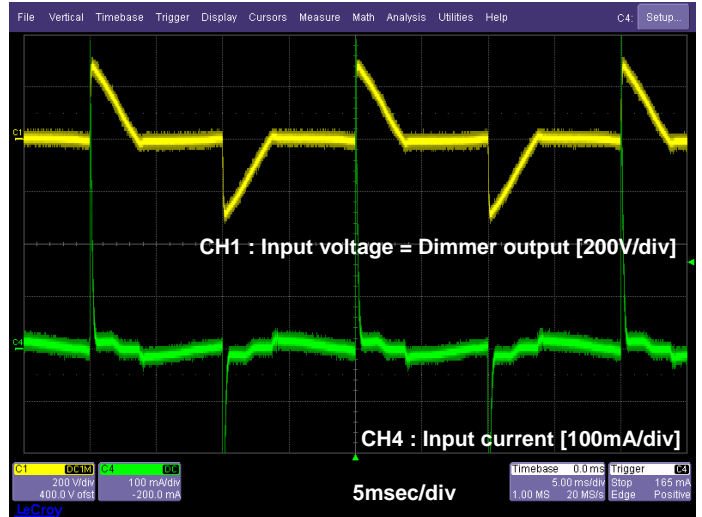

**Figure9.** Dimming operation waveform at phase angle=120degree

### 3.9 Dimming operation waveform

Phase angle = 60 degree

[ VAC=230V, 50Hz, Dimmer : MERTEN 572599 ]



**Figure10.** Dimming operation waveform at phase angle=60degree

## X-ON Electronics

Largest Supplier of Electrical and Electronic Components

*Click to view similar products for [LED Lighting Development Tools](#) category:*

*Click to view products by [ON Semiconductor](#) manufacturer:*

Other Similar products are found below :

[MIC2870YFT EV](#) [ADP8860DBCP-EVALZ](#) [LM3404MREVAL](#) [ADM8843EB-EVALZ](#) [TDGL014](#) [ISL97682IRTZEVALZ](#) [LM3508TLEV](#)  
[EA6358NH](#) [MAX16826EVKIT](#) [MAX16839EVKIT+](#) [TPS92315EVM-516](#) [MAX6956EVKIT+](#) [OM13321,598](#) [DC986A](#) [DC909A](#) [DC824A](#)  
[STEVAL-LLL006V1](#) [IS31LT3948-GRLS4-EB](#) [104PW03F](#) [PIM526](#) [PIM527](#) [MAX6946EVKIT+](#) [MAX20070EVKIT#](#) [MAX21610EVKIT#](#)  
[MAX6951EVKIT](#) [MAX20090BEVKIT#](#) [MAX20092EVSYS#](#) [PIM498](#) [AP8800EV1](#) [ZXLD1370/1EV4](#) [MAX6964EVKIT](#) [TLC59116EVM-](#)  
[390](#) [1216.1013](#) [TPS61176EVM-566](#) [TPS61197EVM](#) [TPS92001EVM-628](#) [1270](#) [1271.2004](#) [1272.1030](#) [1273.1010](#) [1278.1010](#) [1279.1002](#)  
[1279.1001](#) [1282.1000](#) [1293.1900](#) [1293.1800](#) [1293.1700](#) [1293.1500](#) [1293.1100](#) [1282.1400](#)