

# Switch-mode Power Rectifier 100 V, 30 A

## MBR30H100CTG, MBRF30H100CTG

### Features and Benefits

- Low Forward Voltage: 0.67 V @ 125°C
- Low Power Loss/High Efficiency
- High Surge Capacity
- 175°C Operating Junction Temperature
- 30 A Total (15 A Per Diode Leg)
- These are Pb-Free Devices

### Applications

- Power Supply – Output Rectification
- Power Management
- Instrumentation

### Mechanical Characteristics:

- Case: Epoxy, Molded
- Epoxy Meets UL 94 V-0 @ 0.125 in
- Weight: 1.9 Grams (Approximately)
- Finish: All External Surfaces Corrosion Resistant and Terminal Leads are Readily Solderable
- Lead Temperature for Soldering Purposes: 260°C Max. for 10 Seconds
- ESD Rating: Human Body Model = 3B  
Machine Model = C



ON Semiconductor®

[www.onsemi.com](http://www.onsemi.com)

## SCHOTTKY BARRIER RECTIFIER 30 AMPERES 100 VOLTS

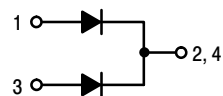

### MARKING DIAGRAMS

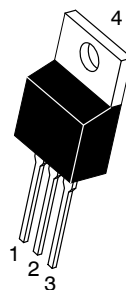

TO-220  
CASE 221A  
STYLE 6

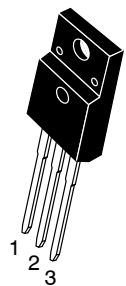
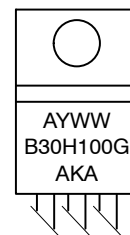

TO-220 FULLPAK  
CASE 221D

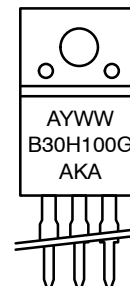

A = Assembly Location  
Y = Year  
WW = Work Week  
B30H100 = Device Code  
G = Pb-Free Package  
AKA = Polarity Designator

### ORDERING INFORMATION

See detailed ordering and shipping information in the package dimensions section on page 2 of this data sheet.

# MBR30H100CTG, MBRF30H100CTG

## MAXIMUM RATINGS (Per Diode Leg)

Rating	Symbol	Value	Unit
Peak Repetitive Reverse Voltage Working Peak Reverse Voltage DC Blocking Voltage	$V_{RRM}$ $V_{RWM}$ $V_R$	100	V
Average Rectified Forward Current ( $T_C = 156^\circ\text{C}$ ) Per Diode Per Device	$I_{F(AV)}$	15 30	A
Peak Repetitive Forward Current (Square Wave, 20 kHz, $T_C = 151^\circ\text{C}$ )	$I_{FM}$	30	A
Nonrepetitive Peak Surge Current (Surge applied at rated load conditions halfwave, single phase, 60 Hz)	$I_{FSM}$	250	A
Operating Junction Temperature (Note 1)	$T_J$	+175	$^\circ\text{C}$
Storage Temperature	$T_{stg}$	-65 to +175	$^\circ\text{C}$
Voltage Rate of Change (Rated $V_R$ )	dv/dt	10,000	V/ $\mu\text{s}$
Controlled Avalanche Energy (see test conditions in Figures 13 and 14)	$W_{AVAIL}$	200	mJ
ESD Ratings: Machine Model = C Human Body Model = 3B		> 400 > 8000	V

Stresses exceeding those listed in the Maximum Ratings table may damage the device. If any of these limits are exceeded, device functionality should not be assumed, damage may occur and reliability may be affected.

1. The heat generated must be less than the thermal conductivity from Junction-to-Ambient:  $dP_D/dT_J < 1/R_{\theta JA}$ .

## THERMAL CHARACTERISTICS

Characteristic	Symbol	Value	Unit
Maximum Thermal Resistance (MBR30H100CTG) - Junction-to-Case - Junction-to-Ambient (MBRF30H100CTG) - Junction-to-Case - Junction-to-Ambient	$R_{\theta JC}$ $R_{\theta JA}$ $R_{\theta JC}$ $R_{\theta JA}$	2.0 60 4.2 75	$^\circ\text{C}/\text{W}$

## ELECTRICAL CHARACTERISTICS (Per Diode Leg)

Characteristic	Symbol	Min	Typ	Max	Unit
Maximum Instantaneous Forward Voltage (Note 2) ( $i_F = 15\text{ A}$ , $T_J = 25^\circ\text{C}$ ) ( $i_F = 15\text{ A}$ , $T_J = 125^\circ\text{C}$ ) ( $i_F = 30\text{ A}$ , $T_J = 25^\circ\text{C}$ ) ( $i_F = 30\text{ A}$ , $T_J = 125^\circ\text{C}$ )	$V_F$	-	0.76 0.64 0.88 0.76	0.80 0.67 0.93 0.80	V
Maximum Instantaneous Reverse Current (Note 2) (Rated DC Voltage, $T_J = 125^\circ\text{C}$ ) (Rated DC Voltage, $T_J = 25^\circ\text{C}$ )	$i_R$	-	1.1 0.0008	6.0 0.0045	mA

Product parametric performance is indicated in the Electrical Characteristics for the listed test conditions, unless otherwise noted. Product performance may not be indicated by the Electrical Characteristics if operated under different conditions.

2. Pulse Test: Pulse Width = 300  $\mu\text{s}$ , Duty Cycle  $\leq 2.0\%$ .

## ORDERING INFORMATION

Device Order Number	Package Type	Shipping <sup>†</sup>
MBR30H100CTG	TO-220 (Pb-Free)	50 Units / Rail
MBRF30H100CTG	TO-220FP (Pb-Free)	50 Units / Rail

# MBR30H100CTG, MBRF30H100CTG

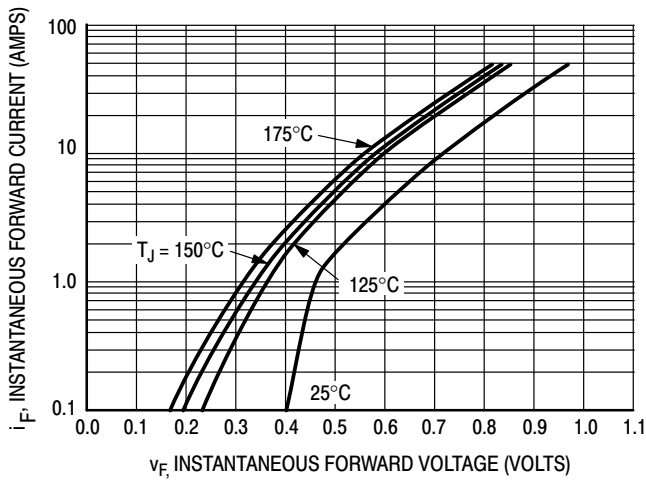

Figure 1. Typical Forward Voltage

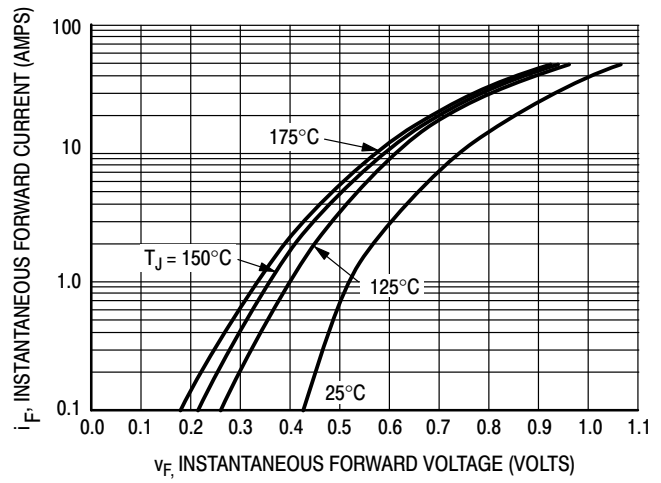

Figure 2. Maximum Forward Voltage

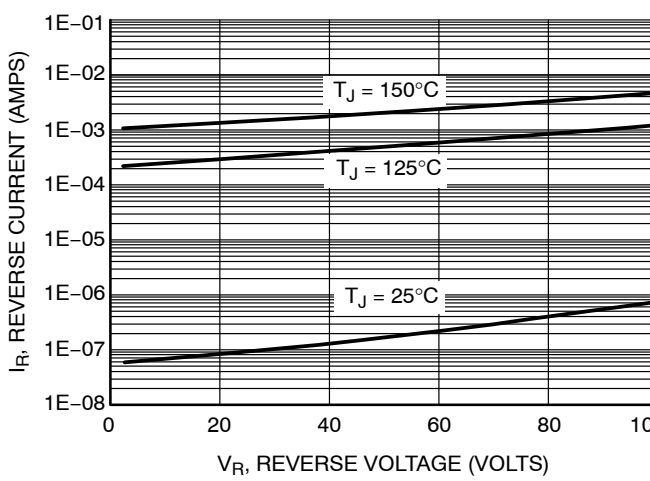

Figure 3. Typical Reverse Current

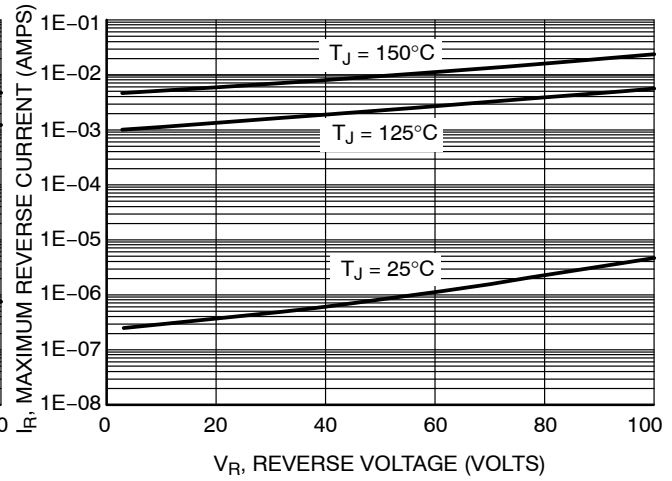

Figure 4. Maximum Reverse Current

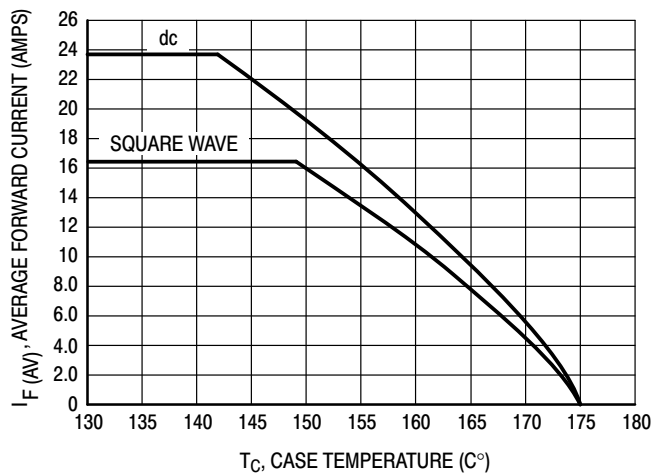

Figure 5. Current Derating, Case Per Leg

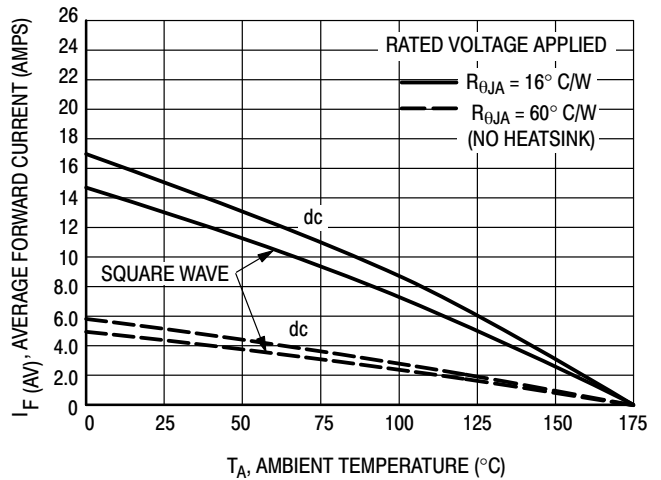

Figure 6. Current Derating, Ambient Per Leg

# MBR30H100CTG, MBRF30H100CTG

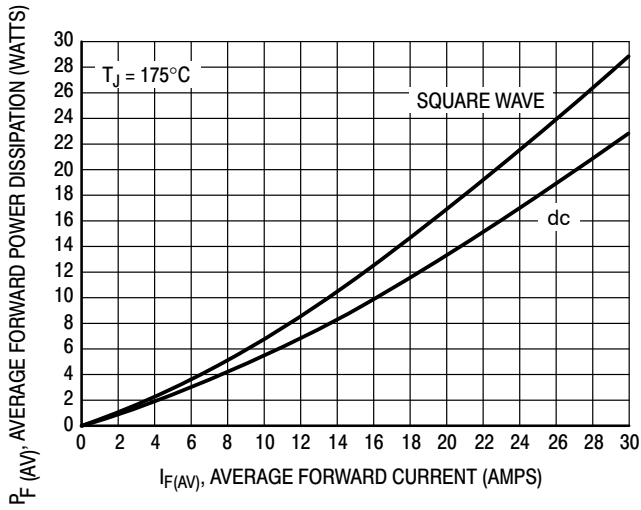

Figure 7. Forward Power Dissipation

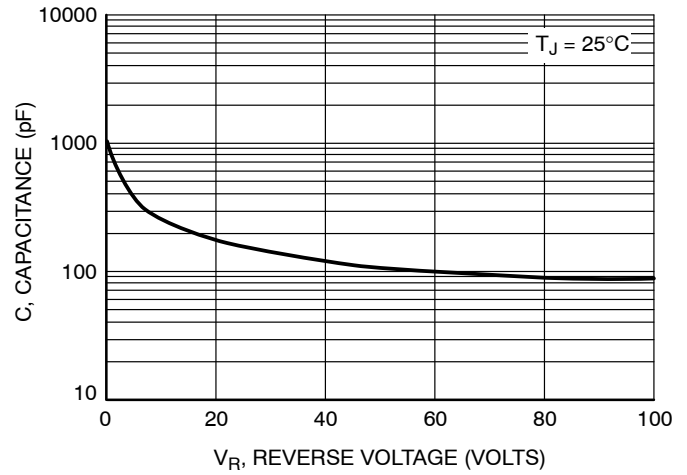

Figure 8. Capacitance

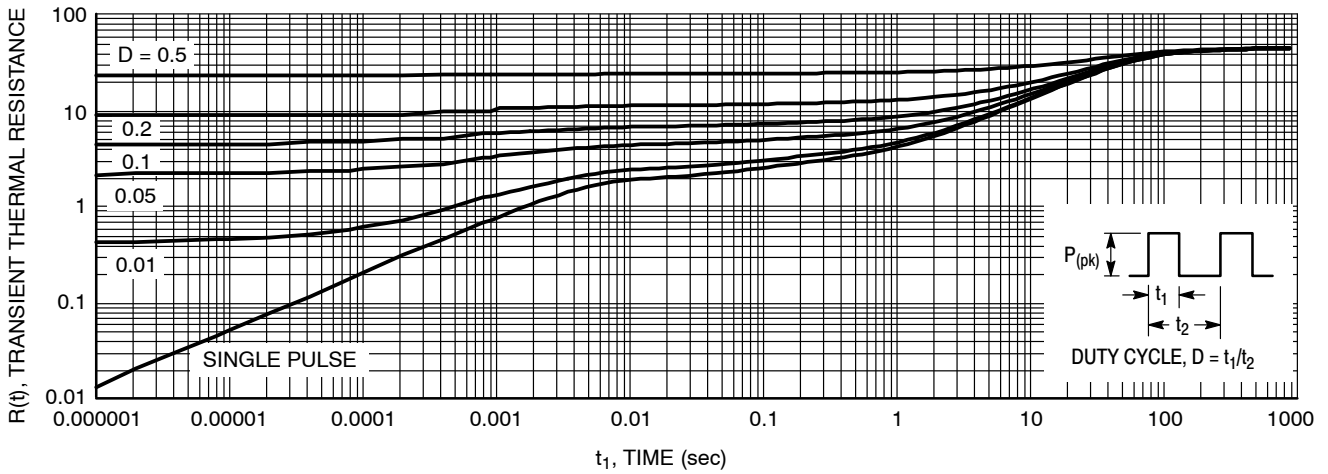

Figure 9. Thermal Response Junction-to-Ambient for MBR30H100CT

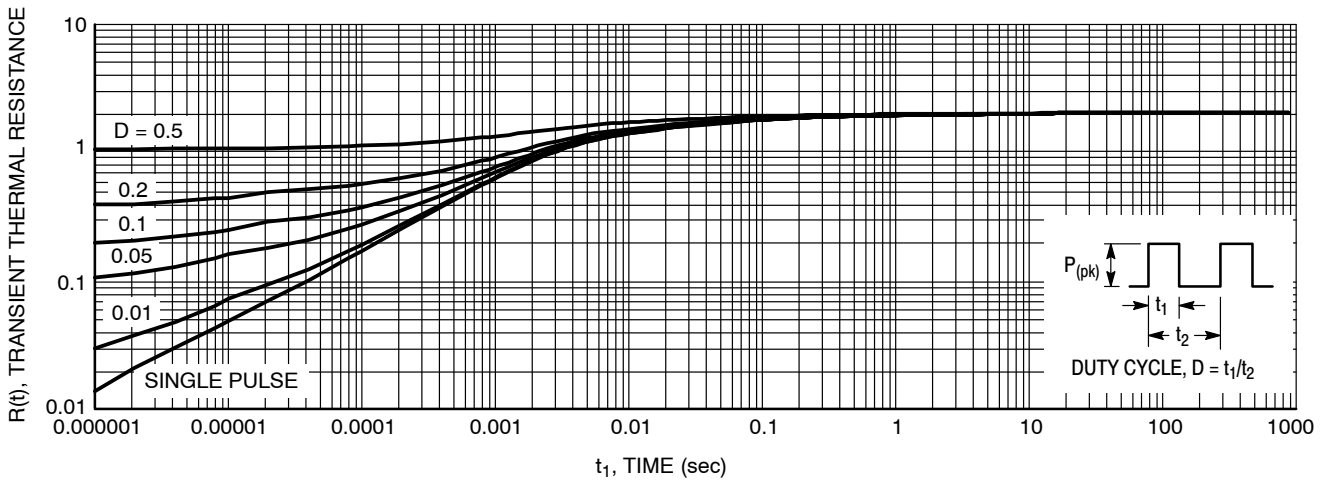

Figure 10. Thermal Response Junction-to-Case for MBR30H100CT

# MBR30H100CTG, MBRF30H100CTG

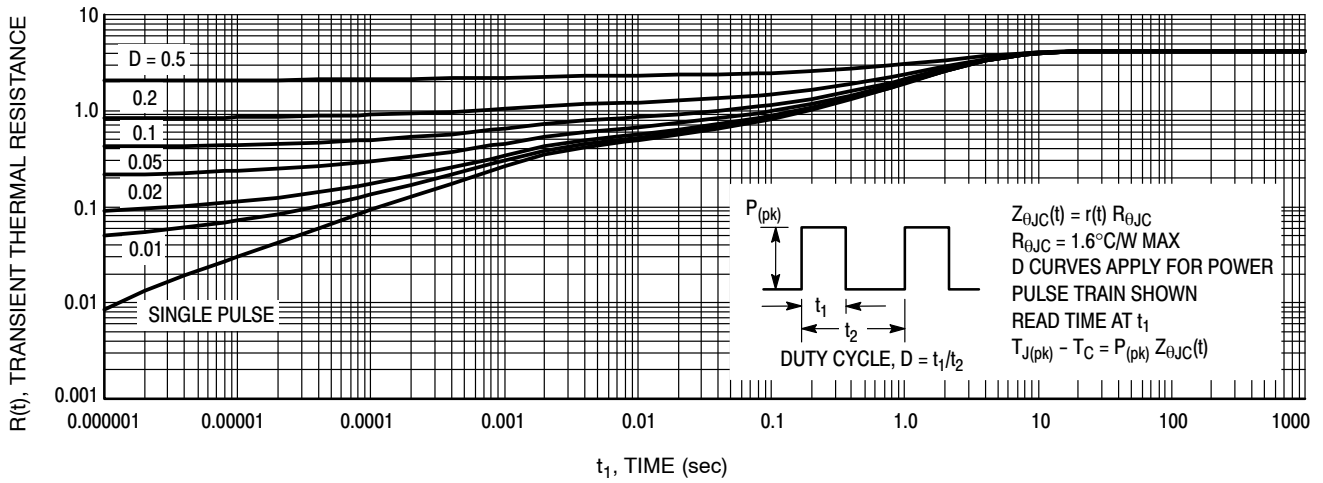

Figure 11. Thermal Response Junction-to-Case for MBRF30H100CT

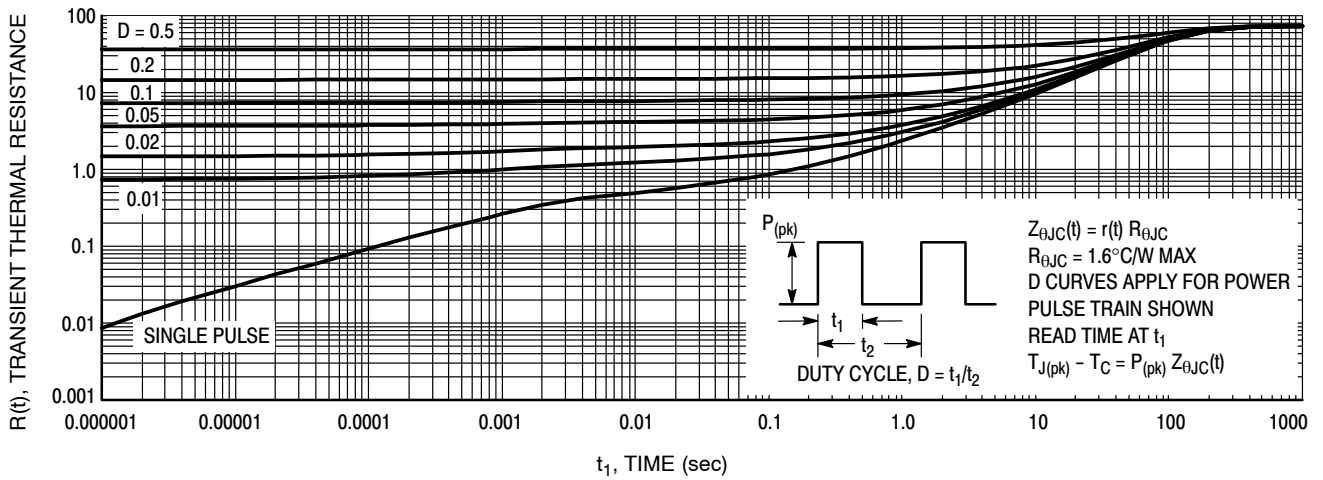

Figure 12. Thermal Response Junction-to-Ambient for MBRF30H100CT

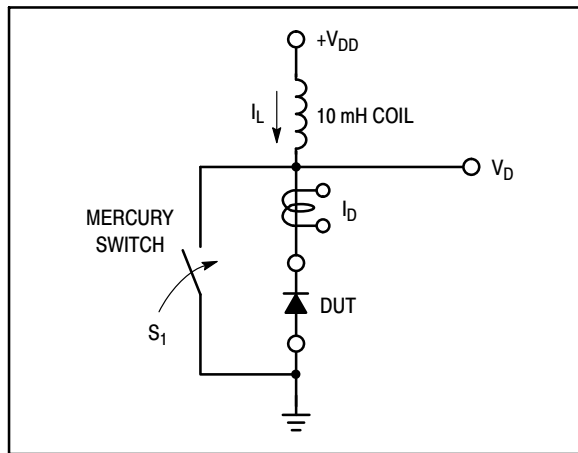

Figure 13. Test Circuit

The unclamped inductive switching circuit shown in Figure 13 was used to demonstrate the controlled avalanche capability of this device. A mercury switch was used instead of an electronic switch to simulate a noisy environment when the switch was being opened.

When  $S_1$  is closed at  $t_0$  the current in the inductor  $I_L$  ramps up linearly; and energy is stored in the coil. At  $t_1$  the switch is opened and the voltage across the diode under test begins to rise rapidly, due to  $di/dt$  effects, when this induced voltage reaches the breakdown voltage of the diode, it is clamped at  $BV_{DUT}$  and the diode begins to conduct the full load current which now starts to decay linearly through the diode, and goes to zero at  $t_2$ .

By solving the loop equation at the point in time when  $S_1$  is opened; and calculating the energy that is transferred to the diode it can be shown that the total energy transferred is equal to the energy stored in the inductor plus a finite amount of energy from the  $V_{DD}$  power supply while the diode is in breakdown (from  $t_1$  to  $t_2$ ) minus any losses due to finite component resistances. Assuming the component resistive

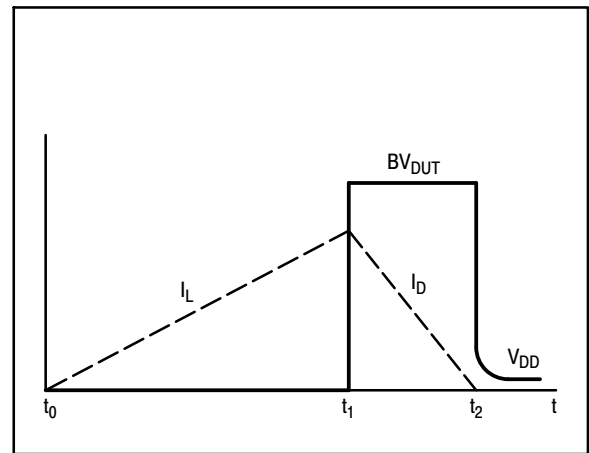

Figure 14. Current-Voltage Waveforms

elements are small Equation (1) approximates the total energy transferred to the diode. It can be seen from this equation that if the  $V_{DD}$  voltage is low compared to the breakdown voltage of the device, the amount of energy contributed by the supply during breakdown is small and the total energy can be assumed to be nearly equal to the energy stored in the coil during the time when  $S_1$  was closed, Equation (2).

EQUATION (1):

$$W_{AVAL} \approx \frac{1}{2} L I_{LPK}^2 \left( \frac{BV_{DUT}}{BV_{DUT} - V_{DD}} \right)$$

EQUATION (2):

$$W_{AVAL} \approx \frac{1}{2} L I_{LPK}^2$$

# MECHANICAL CASE OUTLINE PACKAGE DIMENSIONS

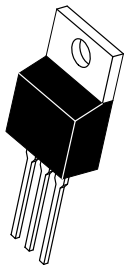

SCALE 1:1



## TO-220 CASE 221A ISSUE AK

DATE 13 JAN 2022

NOTES:

1. DIMENSIONING AND TOLERANCING PER ANSI Y14.5M, 2009.
2. CONTROLLING DIMENSION: INCHES
3. DIMENSION Z DEFINES A ZONE WHERE ALL BODY AND LEAD IRREGULARITIES ARE ALLOWED.
4. MAX WIDTH FOR F102 DEVICE = 1.35MM

DIM	INCHES		MILLIMETERS	
	MIN.	MAX.	MIN.	MAX.
A	0.570	0.620	14.48	15.75
B	0.380	0.415	9.66	10.53
C	0.160	0.190	4.07	4.83
D	0.025	0.038	0.64	0.96
F	0.142	0.161	3.60	4.09
G	0.095	0.105	2.42	2.66
H	0.110	0.161	2.80	4.10
J	0.014	0.024	0.36	0.61
K	0.500	0.562	12.70	14.27
L	0.045	0.060	1.15	1.52
N	0.190	0.210	4.83	5.33
Q	0.100	0.120	2.54	3.04
R	0.080	0.110	2.04	2.79
S	0.045	0.055	1.15	1.41
T	0.235	0.255	5.97	6.47
U	0.000	0.050	0.00	1.27
V	0.045	---	1.15	---
Z	---	0.080	---	2.04

STYLE 1:  
PIN 1. BASE  
2. COLLECTOR  
3. EMITTER  
4. COLLECTOR

STYLE 2:  
PIN 1. BASE  
2. EMITTER  
3. COLLECTOR  
4. EMITTER

STYLE 3:  
PIN 1. CATHODE  
2. ANODE  
3. GATE  
4. ANODE

STYLE 4:  
PIN 1. MAIN TERMINAL 1  
2. MAIN TERMINAL 2  
3. GATE  
4. MAIN TERMINAL 2

STYLE 5:  
PIN 1. GATE  
2. DRAIN  
3. SOURCE  
4. DRAIN

STYLE 6:  
PIN 1. ANODE  
2. CATHODE  
3. ANODE  
4. CATHODE

STYLE 7:  
PIN 1. CATHODE  
2. ANODE  
3. CATHODE  
4. ANODE

STYLE 8:  
PIN 1. CATHODE  
2. ANODE  
3. EXTERNAL TRIP/DELAY  
4. ANODE

STYLE 9:  
PIN 1. GATE  
2. COLLECTOR  
3. EMITTER  
4. COLLECTOR

STYLE 10:  
PIN 1. GATE  
2. SOURCE  
3. DRAIN  
4. SOURCE

STYLE 11:  
PIN 1. DRAIN  
2. SOURCE  
3. GATE  
4. SOURCE

STYLE 12:  
PIN 1. MAIN TERMINAL 1  
2. MAIN TERMINAL 2  
3. GATE  
4. NOT CONNECTED

DOCUMENT NUMBER:	98ASB42148B	Electronic versions are uncontrolled except when accessed directly from the Document Repository. Printed versions are uncontrolled except when stamped "CONTROLLED COPY" in red.
DESCRIPTION:	TO-220	PAGE 1 OF 1

onsemi and onsemi are trademarks of Semiconductor Components Industries, LLC dba onsemi or its subsidiaries in the United States and/or other countries. onsemi reserves the right to make changes without further notice to any products herein. onsemi makes no warranty, representation or guarantee regarding the suitability of its products for any particular purpose, nor does onsemi assume any liability arising out of the application or use of any product or circuit, and specifically disclaims any and all liability, including without limitation special, consequential or incidental damages. onsemi does not convey any license under its patent rights nor the rights of others.

# MECHANICAL CASE OUTLINE PACKAGE DIMENSIONS

ON Semiconductor®

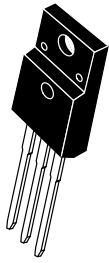

SCALE 1:1

## TO-220 FULLPAK CASE 221D-03 ISSUE K

DATE 27 FEB 2009

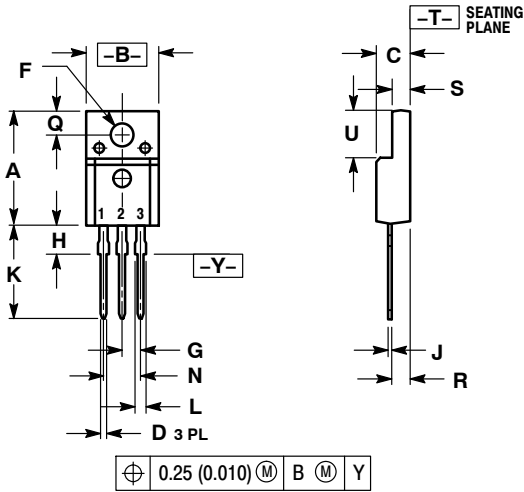

- NOTES:
- DIMENSIONING AND TOLERANCING PER ANSI Y14.5M, 1982.
  - CONTROLLING DIMENSION: INCH
  - 221D-01 THRU 221D-02 OBSOLETE, NEW STANDARD 221D-03.

DIM	INCHES		MILLIMETERS	
	MIN	MAX	MIN	MAX
A	0.617	0.635	15.67	16.12
B	0.392	0.419	9.96	10.63
C	0.177	0.193	4.50	4.90
D	0.024	0.039	0.60	1.00
F	0.116	0.129	2.95	3.28
G	0.100 BSC		2.54 BSC	
H	0.118	0.135	3.00	3.43
J	0.018	0.025	0.45	0.63
K	0.503	0.541	12.78	13.73
L	0.048	0.058	1.23	1.47
N	0.200 BSC		5.08 BSC	
Q	0.122	0.138	3.10	3.50
R	0.099	0.117	2.51	2.96
S	0.092	0.113	2.34	2.87
U	0.239	0.271	6.06	6.88

### MARKING DIAGRAMS

- |  |   |  |
|--|---|--|
| STYLE 1:<br>PIN 1. GATE<br>2. DRAIN<br>3. SOURCE     | STYLE 2:<br>PIN 1. BASE<br>2. COLLECTOR<br>3. EMITTER | STYLE 3:<br>PIN 1. ANODE<br>2. CATHODE<br>3. ANODE |
| STYLE 4:<br>PIN 1. CATHODE<br>2. ANODE<br>3. CATHODE | STYLE 5:<br>PIN 1. CATHODE<br>2. ANODE<br>3. GATE     | STYLE 6:<br>PIN 1. MT 1<br>2. MT 2<br>3. GATE      |



**Bipolar**

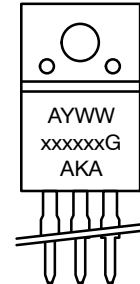

**Rectifier**

- |                               |                           |
|-------------------------------|---------------------------|
| xxxxxx = Specific Device Code | A = Assembly Location     |
| G = Pb-Free Package           | Y = Year                  |
| A = Assembly Location         | WW = Work Week            |
| Y = Year                      | xxxxxx = Device Code      |
| WW = Work Week                | G = Pb-Free Package       |
|                               | AKA = Polarity Designator |

<b>DOCUMENT NUMBER:</b>	<b>98ASB42514B</b>	Electronic versions are uncontrolled except when accessed directly from the Document Repository. Printed versions are uncontrolled except when stamped "CONTROLLED COPY" in red.
<b>DESCRIPTION:</b>	<b>TO-220 FULLPAK</b>	<b>PAGE 1 OF 1</b>

ON Semiconductor and are trademarks of Semiconductor Components Industries, LLC dba ON Semiconductor or its subsidiaries in the United States and/or other countries. ON Semiconductor reserves the right to make changes without further notice to any products herein. ON Semiconductor makes no warranty, representation or guarantee regarding the suitability of its products for any particular purpose, nor does ON Semiconductor assume any liability arising out of the application or use of any product or circuit, and specifically disclaims any and all liability, including without limitation special, consequential or incidental damages. ON Semiconductor does not convey any license under its patent rights nor the rights of others.



**onsemi**, **Onsemi**, and other names, marks, and brands are registered and/or common law trademarks of Semiconductor Components Industries, LLC dba "**onsemi**" or its affiliates and/or subsidiaries in the United States and/or other countries. **onsemi** owns the rights to a number of patents, trademarks, copyrights, trade secrets, and other intellectual property. A listing of **onsemi**'s product/patent coverage may be accessed at [www.onsemi.com/site/pdf/Patent-Marking.pdf](http://www.onsemi.com/site/pdf/Patent-Marking.pdf). **onsemi** reserves the right to make changes at any time to any products or information herein, without notice. The information herein is provided "as-is" and **onsemi** makes no warranty, representation or guarantee regarding the accuracy of the information, product features, availability, functionality, or suitability of its products for any particular purpose, nor does **onsemi** assume any liability arising out of the application or use of any product or circuit, and specifically disclaims any and all liability, including without limitation special, consequential or incidental damages. Buyer is responsible for its products and applications using **onsemi** products, including compliance with all laws, regulations and safety requirements or standards, regardless of any support or applications information provided by **onsemi**. "Typical" parameters which may be provided in **onsemi** data sheets and/or specifications can and do vary in different applications and actual performance may vary over time. All operating parameters, including "Typicals" must be validated for each customer application by customer's technical experts. **onsemi** does not convey any license under any of its intellectual property rights nor the rights of others. **onsemi** products are not designed, intended, or authorized for use as a critical component in life support systems or any FDA Class 3 medical devices or medical devices with a same or similar classification in a foreign jurisdiction or any devices intended for implantation in the human body. Should Buyer purchase or use **onsemi** products for any such unintended or unauthorized application, Buyer shall indemnify and hold **onsemi** and its officers, employees, subsidiaries, affiliates, and distributors harmless against all claims, costs, damages, and expenses, and reasonable attorney fees arising out of, directly or indirectly, any claim of personal injury or death associated with such unintended or unauthorized use, even if such claim alleges that **onsemi** was negligent regarding the design or manufacture of the part. **onsemi** is an Equal Opportunity/Affirmative Action Employer. This literature is subject to all applicable copyright laws and is not for resale in any manner.

## PUBLICATION ORDERING INFORMATION

### LITERATURE FULFILLMENT:

Email Requests to: [orderlit@onsemi.com](mailto:orderlit@onsemi.com)

**onsemi Website:** [www.onsemi.com](http://www.onsemi.com)

### TECHNICAL SUPPORT

**North American Technical Support:**

Voice Mail: 1 800-282-9855 Toll Free USA/Canada

Phone: 011 421 33 790 2910

**Europe, Middle East and Africa Technical Support:**

Phone: 00421 33 790 2910

For additional information, please contact your local Sales Representative

## X-ON Electronics

Largest Supplier of Electrical and Electronic Components

*Click to view similar products for [Schottky Diodes & Rectifiers](#) category:*

*Click to view products by [ON Semiconductor](#) manufacturer:*

Other Similar products are found below :

[MA4E2039](#) [D1FH3-5063](#) [MBR10100CT-BP](#) [MBR1545CT](#) [MMBD301M3T5G](#) [RB160M-50TR](#) [RB551V-30](#) [BAS16E6433HTMA1](#) [BAT](#)  
[54-02LRH E6327](#) [NSR05F40QNXT5G](#) [NTE555](#) [JANS1N6640](#) [SB07-03C-TB-H](#) [SB1003M3-TL-W](#) [SK310-T](#) [SK32A-LTP](#) [SK34B-TP](#)  
[SS3003CH-TL-E](#) [GA01SHT18](#) [CRS10I30A\(TE85L,QM](#) [MA4E2501L-1290](#) [MBRB30H30CT-1G](#) [SB007-03C-TB-E](#) [SK32A-TP](#) [SK33B-TP](#)  
[SK38B-TP](#) [NRVBM120LT1G](#) [NTE505](#) [NTSB30U100CT-1G](#) [SS15E-TP](#) [VS-6CWQ10FNHM3](#) [ACDBA1100LR-HF](#) [ACDBA1200-HF](#)  
[ACDBA140-HF](#) [ACDBA2100-HF](#) [ACDBA3100-HF](#) [CDBQC0530L-HF](#) [ACDBA340-HF](#) [ACDBA260LR-HF](#) [ACDBA1100-HF](#) [SK310B-TP](#)  
[MA4E2502L-1246](#) [MA4E2502H-1246](#) [NRVBM120ET1G](#) [NSR01L30MXT5G](#) [NTE573](#) [NTE6081](#) [SB560](#) [PMAD1108-LF](#) [SD103ATW-TP](#)