

ON Semiconductor

Is Now

onsemi™

To learn more about onsemi™, please visit our website at
www.onsemi.com

onsemi and **onsemi** and other names, marks, and brands are registered and/or common law trademarks of Semiconductor Components Industries, LLC dba "**onsemi**" or its affiliates and/or subsidiaries in the United States and/or other countries. **onsemi** owns the rights to a number of patents, trademarks, copyrights, trade secrets, and other intellectual property. A listing of **onsemi** product/patent coverage may be accessed at www.onsemi.com/site/pdf/Patent-Marking.pdf. **onsemi** reserves the right to make changes at any time to any products or information herein, without notice. The information herein is provided "as-is" and **onsemi** makes no warranty, representation or guarantee regarding the accuracy of the information, product features, availability, functionality, or suitability of its products for any particular purpose, nor does **onsemi** assume any liability arising out of the application or use of any product or circuit, and specifically disclaims any and all liability, including without limitation special, consequential or incidental damages. Buyer is responsible for its products and applications using **onsemi** products, including compliance with all laws, regulations and safety requirements or standards, regardless of any support or applications information provided by **onsemi**. "Typical" parameters which may be provided in **onsemi** data sheets and/or specifications can and do vary in different applications and actual performance may vary over time. All operating parameters, including "Typicals" must be validated for each customer application by customer's technical experts. **onsemi** does not convey any license under any of its intellectual property rights nor the rights of others. **onsemi** products are not designed, intended, or authorized for use as a critical component in life support systems or any FDA Class 3 medical devices or medical devices with a same or similar classification in a foreign jurisdiction or any devices intended for implantation in the human body. Should Buyer purchase or use **onsemi** products for any such unintended or unauthorized application, Buyer shall indemnify and hold **onsemi** and its officers, employees, subsidiaries, affiliates, and distributors harmless against all claims, costs, damages, and expenses, and reasonable attorney fees arising out of, directly or indirectly, any claim of personal injury or death associated with such unintended or unauthorized use, even if such claim alleges that **onsemi** was negligent regarding the design or manufacture of the part. **onsemi** is an Equal Opportunity/Affirmative Action Employer. This literature is subject to all applicable copyright laws and is not for resale in any manner. Other names and brands may be claimed as the property of others.

MC74AC257, MC74ACT257

Quad 2-Input Multiplexer with 3-State Outputs

The MC74AC257/74ACT257 is a quad 2-input multiplexer with 3-state outputs. Four bits of data from two sources can be selected using a Common Data Select input. The four outputs present the selected data in true (noninverted) form. The outputs may be switched to a high impedance state by placing a logic HIGH on the common Output Enable (\overline{OE}) input, allowing the outputs to interface directly with bus-oriented systems.

- Multiplexer Expansion by Tying Outputs Together
- Noninverting 3-State Outputs
- Outputs Source/Sink 24 mA
- 'ACT257 Has TTL Compatible Inputs
- These are Pb-Free Devices

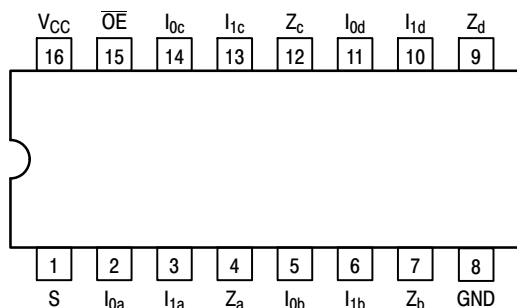

Figure 1. Pinout: 16-Lead Packages Conductors (Top View)



ON Semiconductor®

www.onsemi.com

MARKING DIAGRAMS

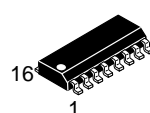

SOIC-16
D SUFFIX
CASE 751B

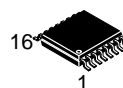
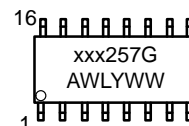

TSSOP-16
DT SUFFIX
CASE 948F

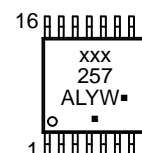

xxx = AC or ACT
A = Assembly Location
WL or L = Wafer Lot
Y = Year
WW or W = Work Week
G or ■ = Pb-Free Package

(Note: Microdot may be in either location)

ORDERING INFORMATION

See detailed ordering and shipping information in the package dimensions section on page 7 of this data sheet.

MC74AC257, MC74ACT257

PIN NAME

| PIN | FUNCTION |
|-----------------|-----------------------------|
| S | Common Data Select Input |
| \overline{OE} | 3-State Output Enable Input |
| $I_{0a}-I_{0d}$ | Data Inputs from Source 0 |
| $I_{1a}-I_{1d}$ | Data Inputs from Source 1 |
| Z_a-Z_d | 3-State Multiplexer Outputs |

TRUTH TABLE

| Output Enable | Select Input | Data Inputs | | Outputs |
|-----------------|--------------|-------------|-------|---------|
| \overline{OE} | S | I_0 | I_1 | Z |
| H | X | X | X | Z |
| L | H | X | L | L |
| L | H | X | H | H |
| L | L | L | X | L |
| L | L | H | X | H |

H = HIGH Voltage Level
 L = LOW Voltage Level
 X = Immaterial
 Z = High Impedance

FUNCTIONAL DESCRIPTION

The MC74AC257/74ACT257 is a quad 2-input multiplexer with 3-state outputs. It selects four bits of data from two sources under control of a Common Data Select input. When the Select input is LOW, the I_{0x} inputs are selected and when Select is HIGH, the I_{1x} inputs are selected. The data on the selected inputs appears at the outputs in true (noninverted) form. The device is the logic implementation of a 4-pole, 2-position switch where the position of the switch is determined by the logic levels supplied to the Select input. The logic equations for the outputs are shown below:

$$Z_a = \overline{OE} \cdot (I_{1a} \cdot S + I_{0a} \cdot \overline{S})$$

$$Z_b = \overline{OE} \cdot (I_{1b} \cdot S + I_{0b} \cdot \overline{S})$$

$$Z_c = \overline{OE} \cdot (I_{1c} \cdot S + I_{0c} \cdot \overline{S})$$

$$Z_d = \overline{OE} \cdot (I_{1d} \cdot S + I_{0d} \cdot \overline{S})$$

When the Output Enable input (\overline{OE}) is HIGH, the outputs are forced to a high impedance state. If the outputs are tied together, all but one device must be in the high impedance state to avoid high currents that would exceed the maximum ratings. Designers should ensure the Output Enable signals to 3-state devices whose outputs are tied together are designed so there is no overlap.

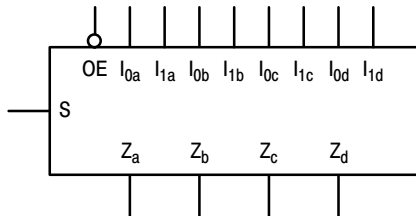
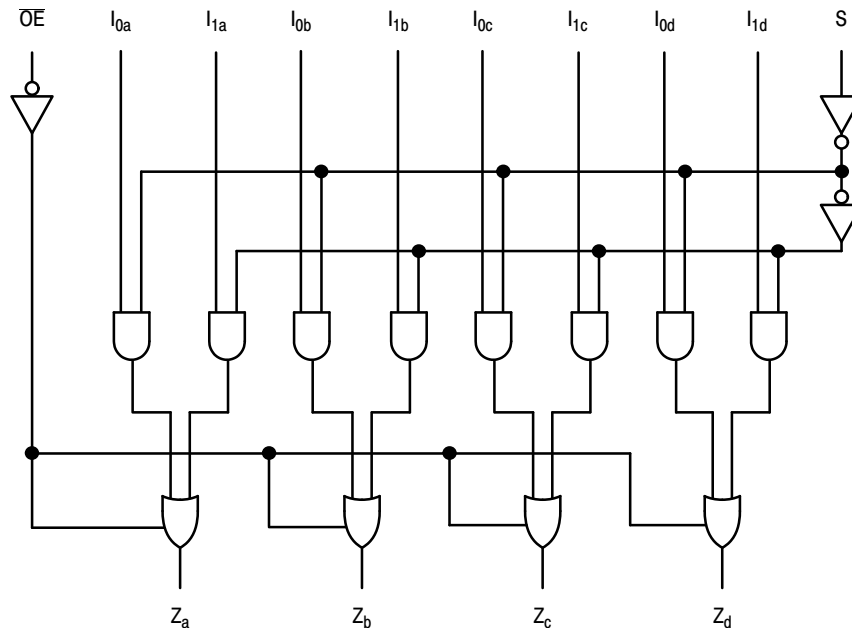

Figure 2. Logic Symbol



NOTE: This diagram is provided only for the understanding of logic operations and should not be used to estimate propagation delays.

Figure 3. Logic Diagram

MC74AC257, MC74ACT257

MAXIMUM RATINGS

| Symbol | Parameter | Value | Unit |
|-----------------------|---|--|---------------------------|
| V _{CC} | DC Supply Voltage | -0.5 to +7.0 | V |
| V _I | DC Input Voltage | -0.5 ≤ V _{CC} +0.5 | V |
| V _O | DC Output Voltage (Note 1) | -0.5 ≤ V _{CC} +0.5 | V |
| I _{IK} | DC Input Diode Current | ±20 | mA |
| I _{OK} | DC Output Diode Current | ±50 | mA |
| I _O | DC Output Sink/Source Current | ±50 | mA |
| I _{CC} | DC Supply Current per Output Pin | ±50 | mA |
| I _{GND} | DC Ground Current per Output Pin | ±50 | mA |
| T _{STG} | Storage Temperature Range | -65 to +150 | °C |
| T _L | Lead temperature, 1 mm from Case for 10 Seconds | 260 | °C |
| T _J | Junction temperature under Bias | +150 | °C |
| θ _{JA} | Thermal Resistance (Note 2) | SOIC TSSOP 69.1 103.8 | °C/W |
| P _D | Power Dissipation in Still Air at 65°C (Note 3) | SOIC TSSOP 500 500 | mW |
| MSL | Moisture Sensitivity | Level 1 | |
| F _R | Flammability Rating | Oxygen Index: 30% – 35% | UL 94 V-0 @ 0.125 in |
| V _{ESD} | ESD Withstand Voltage | Human Body Model (Note 4) Machine Model (Note 5) Charged Device Model (Note 6) | > 2000 > 200 > 1000 |
| I _{Latch-Up} | Latch-Up Performance | Above V _{CC} and Below GND at 85°C (Note 7) | ±100 |

Stresses exceeding those listed in the Maximum Ratings table may damage the device. If any of these limits are exceeded, device functionality should not be assumed, damage may occur and reliability may be affected.

1. I_O absolute maximum rating must be observed.
2. The package thermal impedance is calculated in accordance with JESD51-7.
3. 500 mW at 65°C; derate to 300 mW by 10 mW/ from 65°C to 85°C.
4. Tested to EIA/JESD22-A114-A.
5. Tested to EIA/JESD22-A115-A.
6. Tested to JESD22-C101-A.
7. Tested to EIA/JESD78.

RECOMMENDED OPERATING CONDITIONS

| Symbol | Parameter | Min | Typ | Max | Unit | |
|------------------------------------|---|-------------------------|-----|-----------------|------|------|
| V _{CC} | Supply Voltage | 'AC | 2.0 | 5.0 | 6.0 | V |
| | | 'ACT | 4.5 | 5.0 | 5.5 | |
| V _{IN} , V _{OUT} | DC Input Voltage, Output Voltage (Ref. to GND) | 0 | - | V _{CC} | V | |
| t _r , t _f | Input Rise and Fall Time (Note 1) 'AC Devices except Schmitt Inputs | V _{CC} @ 3.0 V | - | 150 | - | ns/V |
| | | V _{CC} @ 4.5 V | - | 40 | - | |
| | | V _{CC} @ 5.5 V | - | 25 | - | |
| t _r , t _f | Input Rise and Fall Time (Note 2) 'ACT Devices except Schmitt Inputs | V _{CC} @ 4.5 V | - | 10 | - | ns/V |
| | | V _{CC} @ 5.5 V | - | 8.0 | - | |
| T _A | Operating Ambient Temperature Range | -40 | 25 | 85 | °C | |
| I _{OH} | Output Current – High | - | - | -24 | mA | |
| I _{OL} | Output Current – Low | - | - | 24 | mA | |

Functional operation above the stresses listed in the Recommended Operating Ranges is not implied. Extended exposure to stresses beyond the Recommended Operating Ranges limits may affect device reliability.

1. 1. V_{in} from 30% to 70% V_{CC}; see individual Data Sheets for devices that differ from the typical input rise and fall times.
2. 2. V_{in} from 0.8 V to 2.0 V; see individual Data Sheets for devices that differ from the typical input rise and fall times.

MC74AC257, MC74ACT257

DC CHARACTERISTICS

| Symbol | Parameter | V _{CC} (V) | 74AC | | 74AC | Unit | Conditions |
|------------------|--------------------------------------|------------------------|------------------------|-------------------|---------------------------------------|------|---|
| | | | T _A = +25°C | | T _A = -40°C to +85°C | | |
| | | | Typ | Guaranteed Limits | | | |
| V _{IH} | Minimum High Level Input Voltage | 3.0 | 1.5 | 2.1 | 2.1 | V | V _{OUT} = 0.1 V or V _{CC} - 0.1 V |
| | | 4.5 | 2.25 | 3.15 | 3.15 | | |
| | | 5.5 | 2.75 | 3.85 | 3.85 | | |
| V _{IL} | Maximum Low Level Input Voltage | 3.0 | 1.5 | 0.9 | 0.9 | V | V _{OUT} = 0.1 V or V _{CC} - 0.1 V |
| | | 4.5 | 2.25 | 1.35 | 1.35 | | |
| | | 5.5 | 2.75 | 1.65 | 1.65 | | |
| V _{OH} | Minimum High Level Output Voltage | 3.0 | 2.99 | 2.9 | 2.9 | V | I _{OUT} = -50 μA |
| | | 4.5 | 4.49 | 4.4 | 4.4 | | |
| | | 5.5 | 5.49 | 5.4 | 5.4 | | |
| | | 3.0 | - | 2.56 | 2.46 | V | *V _{IN} = V _{IL} or V _{IH} -12 mA I _{OH} -24 mA -24 mA |
| | | 4.5 | - | 3.86 | 3.76 | | |
| | | 5.5 | - | 4.86 | 4.76 | | |
| V _{OL} | Maximum Low Level Output Voltage | 3.0 | 0.002 | 0.1 | 0.1 | V | I _{OUT} = 50 μA |
| | | 4.5 | 0.001 | 0.1 | 0.1 | | |
| | | 5.5 | 0.001 | 0.1 | 0.1 | | |
| | | 3.0 | - | 0.36 | 0.44 | V | *V _{IN} = V _{IL} or V _{IH} 12 mA I _{OL} 24 mA 24 mA |
| | | 4.5 | - | 0.36 | 0.44 | | |
| | | 5.5 | - | 0.36 | 0.44 | | |
| I _{IN} | Maximum Input Leakage Current | 5.5 | - | ±0.1 | ±1.0 | μA | V _I = V _{CC} , GND |
| I _{OZ} | Maximum 3-State Current | 5.5 | - | ±0.5 | ±5.0 | μA | V _I (OE) = V _{IL} , V _{IH} V _I = V _{CC} , GND V _O = V _{CC} , GND |
| I _{OLD} | †Minimum Dynamic Output Current | 5.5 | - | - | 75 | mA | V _{OLD} = 1.65 V Max |
| I _{OHD} | | 5.5 | - | - | -75 | mA | V _{OHD} = 3.85 V Min |
| I _{CC} | Maximum Quiescent Supply Current | 5.5 | - | 8.0 | 80 | μA | V _{IN} = V _{CC} or GND |

*All outputs loaded; thresholds on input associated with output under test.

†Maximum test duration 2.0 ms, one output loaded at a time.

NOTE: I_{IN} and I_{CC} @ 3.0 V are guaranteed to be less than or equal to the respective limit @ 5.5 V V_{CC}.

MC74AC257, MC74ACT257

AC CHARACTERISTICS (For Figures and Waveforms – See Section 3 of the ON Semiconductor FACT Data Book, DL138/D)

| Symbol | Parameter | V _{CC} * (V) | 74AC | | | 74AC | | Unit | Fig. No. |
|------------------|---|--------------------------|--|------------|-------------|--|--------------|------|----------|
| | | | T _A = +25°C C _L = 50 pF | | | T _A = -40°C to +85°C C _L = 50 pF | | | |
| | | | Min | Typ | Max | Min | Max | | |
| t _{PLH} | Propagation Delay I _n to Z _n | 3.3 5.0 | 1.5 1.5 | 5.0 4.0 | 8.5 6.0 | 1.0 1.0 | 9.0 7.0 | ns | 3-5 |
| t _{PHL} | Propagation Delay I _n to Z _n | 3.3 5.0 | 1.5 1.5 | 6.0 4.5 | 8.5 6.0 | 1.0 1.0 | 9.0 7.0 | ns | 3-5 |
| t _{PLH} | Propagation Delay S to Z _n | 3.3 5.0 | 1.5 1.5 | 7.0 5.0 | 10.5 7.5 | 1.5 1.0 | 11.5 8.5 | ns | 3-6 |
| t _{PHL} | Propagation Delay S to Z _n | 3.3 5.0 | 1.5 1.5 | 7.5 5.5 | 10.5 7.5 | 1.5 1.0 | 11.5 8.5 | ns | 3-6 |
| t _{PZH} | Output Enable Time | 3.3 5.0 | 1.5 1.5 | 6.5 5.0 | 9.5 7.5 | 1.0 1.0 | 10.5 8.5 | ns | 3-7 |
| t _{PZL} | Output Enable Time | 3.3 5.0 | 1.5 1.5 | 5.5 5.0 | 9.0 8.5 | 1.0 1.0 | 10.0 9.5 | ns | 3-8 |
| t _{PHZ} | Output Disable Time | 3.3 5.0 | 1.5 1.5 | 5.5 5.0 | 10.0 9.0 | 1.0 1.0 | 11.0 10.0 | ns | 3-7 |
| t _{PLZ} | Output Disable Time | 3.3 5.0 | 1.5 1.5 | 5.5 5.0 | 9.0 8.0 | 1.0 1.0 | 10.0 9.0 | ns | 3-8 |

*Voltage Range 3.3 V is 3.3 V ±0.3 V.

*Voltage Range 5.0 V is 5.0 V ±0.5 V.

MC74AC257, MC74ACT257

DC CHARACTERISTICS

| Symbol | Parameter | V _{CC} (V) | 74ACT | | 74ACT | Unit | Conditions |
|-------------------|--|------------------------|------------------------|-------------------|---------------------------------------|------|---|
| | | | T _A = +25°C | | T _A = -40°C to +85°C | | |
| | | | Typ | Guaranteed Limits | | | |
| V _{IH} | Minimum High Level Input Voltage | 4.5 | 1.5 | 2.0 | 2.0 | V | V _{OUT} = 0.1 V or V _{CC} - 0.1 V |
| | | 5.5 | 1.5 | 2.0 | 2.0 | | |
| V _{IL} | Maximum Low Level Input Voltage | 4.5 | 1.5 | 0.8 | 0.8 | V | V _{OUT} = 0.1 V or V _{CC} - 0.1 V |
| | | 5.5 | 1.5 | 0.8 | 0.8 | | |
| V _{OH} | Minimum High Level Output Voltage | 4.5 | 4.49 | 4.4 | 4.4 | V | I _{OUT} = -50 μA |
| | | 5.5 | 5.49 | 5.4 | 5.4 | | |
| | | 4.5 | - | 3.86 | 3.76 | V | *V _{IN} = V _{IL} or V _{IH} -24 mA I _{OH} -24 mA |
| | | 5.5 | - | 4.86 | 4.76 | | |
| V _{OL} | Maximum Low Level Output Voltage | 4.5 | 0.001 | 0.1 | 0.1 | V | I _{OUT} = 50 μA |
| | | 5.5 | 0.001 | 0.1 | 0.1 | | |
| | | 4.5 | - | 0.36 | 0.44 | V | *V _{IN} = V _{IL} or V _{IH} 24 mA I _{OL} 24 mA |
| | | 5.5 | - | 0.36 | 0.44 | | |
| I _{IN} | Maximum Input Leakage Current | 5.5 | - | ±0.1 | ±1.0 | μA | V _I = V _{CC} , GND |
| ΔI _{CCT} | Additional Max. I _{CC} /Input | 5.5 | 0.6 | - | 1.5 | mA | V _I = V _{CC} - 2.1 V |
| I _{OZ} | Maximum 3-State Current | 5.5 | - | ±0.5 | ±5.0 | μA | V _I (OE) = V _{IL} , V _{IH} V _I = V _{CC} , GND V _O = V _{CC} , GND |
| I _{OLD} | †Minimum Dynamic Output Current | 5.5 | - | - | 75 | mA | V _{OLD} = 1.65 V Max |
| I _{OHD} | | 5.5 | - | - | -75 | mA | V _{OHD} = 3.85 V Min |
| I _{CC} | Maximum Quiescent Supply Current | 5.5 | - | 8.0 | 80 | μA | V _{IN} = V _{CC} or GND |

*All outputs loaded; thresholds on input associated with output under test.

†Maximum test duration 2.0 ms, one output loaded at a time.

MC74AC257, MC74ACT257

AC CHARACTERISTICS (For Figures and Waveforms – See Section 3 of the ON Semiconductor FACT Data Book, DL138/D)

| Symbol | Parameter | V _{CC} * (V) | 74ACT | | | 74ACT | | Unit | Fig. No. |
|------------------|---|--------------------------|--|-----|------|--|------|------|----------|
| | | | T _A = +25°C C _L = 50 pF | | | T _A = -40°C to +85°C C _L = 50 pF | | | |
| | | | Min | Typ | Max | Min | Max | | |
| t _{PLH} | Propagation Delay I _n to Z _n | 5.0 | 1.5 | 5.0 | 7.0 | 1.0 | 7.5 | ns | 3–6 |
| t _{PHL} | Propagation Delay I _n to Z _n | 5.0 | 2.0 | 6.0 | 7.5 | 1.5 | 8.5 | ns | 3–6 |
| t _{PLH} | Propagation Delay S to Z _n | 5.0 | 2.0 | 7.0 | 9.5 | 1.5 | 10.5 | ns | 3–6 |
| t _{PHL} | Propagation Delay S to Z _n | 5.0 | 2.5 | 7.0 | 10.5 | 2.0 | 11.5 | ns | 3–6 |
| t _{PZH} | Output Enable Time | 5.0 | 2.0 | 6.0 | 8.0 | 1.5 | 9.0 | ns | 3–7 |
| t _{PZL} | Output Enable Time | 5.0 | 2.0 | 6.0 | 8.0 | 1.5 | 9.0 | ns | 3–8 |
| t _{PHZ} | Output Disable Time | 5.0 | 2.5 | 6.5 | 9.0 | 1.5 | 10.0 | ns | 3–7 |
| t _{PLZ} | Output Disable Time | 5.0 | 2.0 | 6.0 | 7.5 | 1.5 | 8.5 | ns | 3–8 |

*Voltage Range 5.0 V is 5.0 V ±0.5 V.

CAPACITANCE

| Symbol | Parameter | Value Typ | Unit | Test Conditions |
|-----------------|-------------------------------|--------------|------|-------------------------|
| C _{IN} | Input Capacitance | 4.5 | pF | V _{CC} = 5.0 V |
| C _{PD} | Power Dissipation Capacitance | 50 | pF | V _{CC} = 5.0 V |

ORDERING INFORMATION

| Device Order Number | Package | Shipping† |
|---------------------|-----------------------|--------------------|
| MC74AC257DG | SOIC–16 (Pb–Free) | 48 Units / Rail |
| MC74AC257DR2G | SOIC–16 (Pb–Free) | 2500 / Tape & Reel |
| MC74AC257DTR2G | TSSOP–16 (Pb–Free) | 2500 / Tape & Reel |
| MC74ACT257DG | SOIC–16 (Pb–Free) | 48 Units / Rail |
| MC74ACT257DR2G | SOIC–16 (Pb–Free) | 2500 / Tape & Reel |
| MC74ACT257DTR2G | TSSOP–16 (Pb–Free) | 2500 / Tape & Reel |

†For information on tape and reel specifications, including part orientation and tape sizes, please refer to our Tape and Reel Packaging Specifications Brochure, BRD8011/D.

MC74AC257, MC74ACT257

PACKAGE DIMENSIONS

TSSOP-16
DT SUFFIX
CASE 948F
ISSUE B

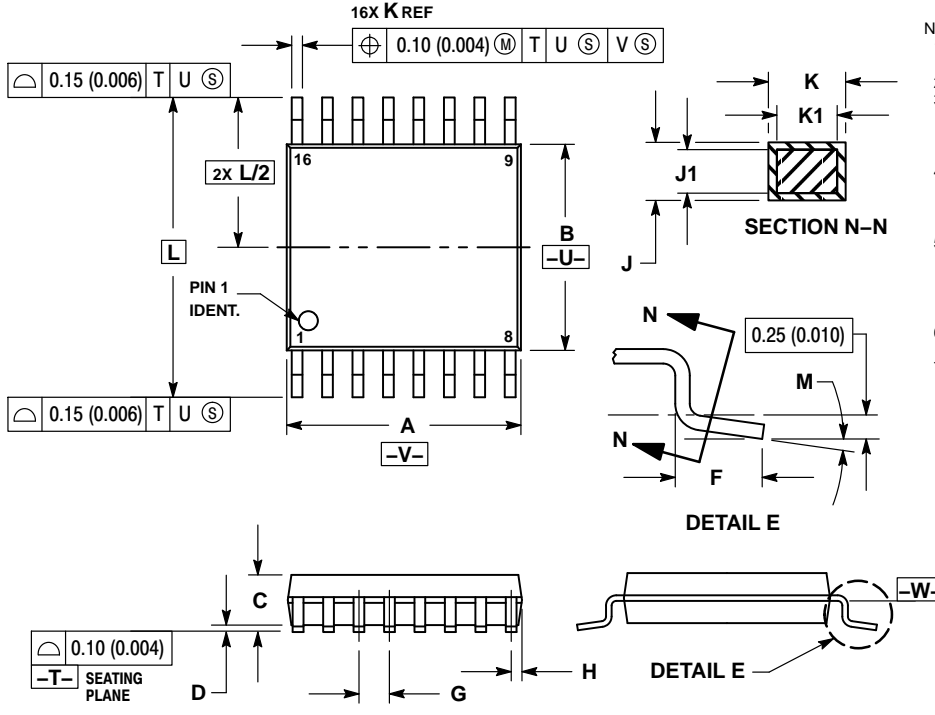

NOTES:

1. DIMENSIONING AND TOLERANCING PER ANSI Y14.5M, 1982.
2. CONTROLLING DIMENSION: MILLIMETER.
3. DIMENSION A DOES NOT INCLUDE MOLD FLASH. PROTRUSIONS OR GATE BURRS. MOLD FLASH OR GATE BURRS SHALL NOT EXCEED 0.15 (0.006) PER SIDE.
4. DIMENSION B DOES NOT INCLUDE INTERLEAD FLASH OR PROTRUSION. INTERLEAD FLASH OR PROTRUSION SHALL NOT EXCEED 0.25 (0.010) PER SIDE.
5. DIMENSION K DOES NOT INCLUDE DAMBAR PROTRUSION. ALLOWABLE DAMBAR PROTRUSION SHALL BE 0.08 (0.003) TOTAL IN EXCESS OF THE K DIMENSION AT MAXIMUM MATERIAL CONDITION.
6. TERMINAL NUMBERS ARE SHOWN FOR REFERENCE ONLY.
7. DIMENSION A AND B ARE TO BE DETERMINED AT DATUM PLANE -W-.

| DIM | MILLIMETERS | | INCHES | |
|-----|-------------|------|-----------|-------|
| | MIN | MAX | MIN | MAX |
| A | 4.90 | 5.10 | 0.193 | 0.200 |
| B | 4.30 | 4.50 | 0.169 | 0.177 |
| C | --- | 1.20 | --- | 0.047 |
| D | 0.05 | 0.15 | 0.002 | 0.006 |
| F | 0.50 | 0.75 | 0.020 | 0.030 |
| G | 0.65 BSC | | 0.026 BSC | |
| H | 0.18 | 0.28 | 0.007 | 0.011 |
| J | 0.09 | 0.20 | 0.004 | 0.008 |
| J1 | 0.09 | 0.16 | 0.004 | 0.006 |
| K | 0.19 | 0.30 | 0.007 | 0.012 |
| K1 | 0.19 | 0.25 | 0.007 | 0.010 |
| L | 6.40 BSC | | 0.252 BSC | |
| M | 0° | 8° | 0° | 8° |

SOLDERING FOOTPRINT*

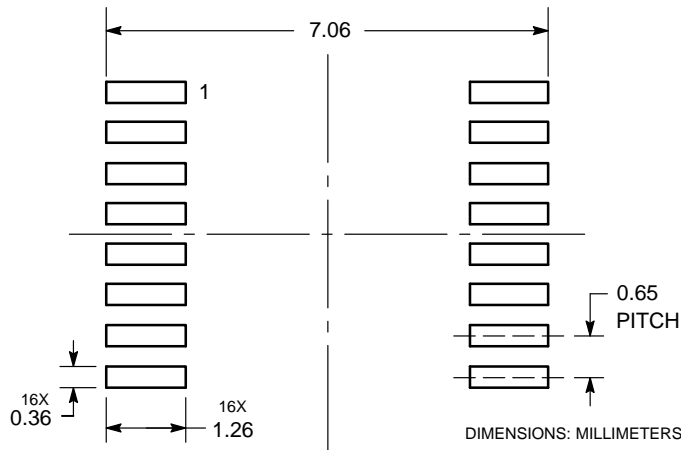

*For additional information on our Pb-Free strategy and soldering details, please download the ON Semiconductor Soldering and Mounting Techniques Reference Manual, SOLDERRM/D.

MC74AC257, MC74ACT257

PACKAGE DIMENSIONS

SOIC-16
D SUFFIX
CASE 751B-05
ISSUE K

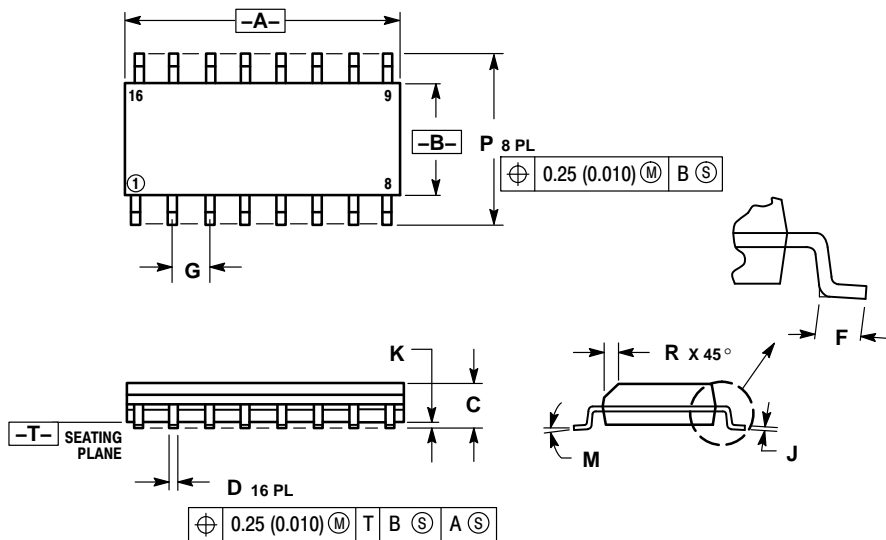

NOTES:

1. DIMENSIONING AND TOLERANCING PER ANSI Y14.5M, 1982.
2. CONTROLLING DIMENSION: MILLIMETER.
3. DIMENSIONS A AND B DO NOT INCLUDE MOLD PROTRUSION.
4. MAXIMUM MOLD PROTRUSION 0.15 (0.006) PER SIDE.
5. DIMENSION D DOES NOT INCLUDE DAMBAR PROTRUSION. ALLOWABLE DAMBAR PROTRUSION SHALL BE 0.127 (0.005) TOTAL IN EXCESS OF THE D DIMENSION AT MAXIMUM MATERIAL CONDITION.

| DIM | MILLIMETERS | | INCHES | |
|-----|-------------|-------|-----------|-------|
| | MIN | MAX | MIN | MAX |
| A | 9.80 | 10.00 | 0.386 | 0.393 |
| B | 3.80 | 4.00 | 0.150 | 0.157 |
| C | 1.35 | 1.75 | 0.054 | 0.068 |
| D | 0.35 | 0.49 | 0.014 | 0.019 |
| F | 0.40 | 1.25 | 0.016 | 0.049 |
| G | 1.27 BSC | | 0.050 BSC | |
| J | 0.19 | 0.25 | 0.008 | 0.009 |
| K | 0.10 | 0.25 | 0.004 | 0.009 |
| M | 0° | 7° | 0° | 7° |
| P | 5.80 | 6.20 | 0.229 | 0.244 |
| R | 0.25 | 0.50 | 0.010 | 0.019 |

SOLDERING FOOTPRINT*

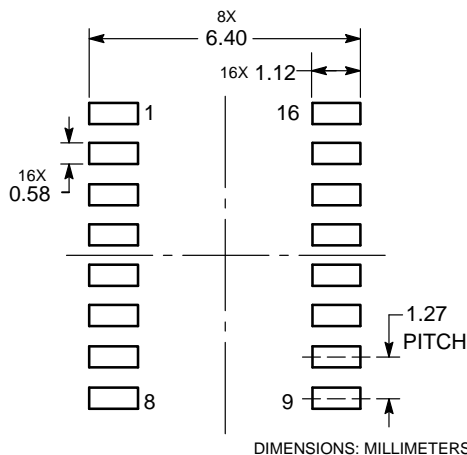

DIMENSIONS: MILLIMETERS

*For additional information on our Pb-Free strategy and soldering details, please download the ON Semiconductor Soldering and Mounting Techniques Reference Manual, SOLDERRM/D.

ON Semiconductor and the are registered trademarks of Semiconductor Components Industries, LLC (SCILLC) or its subsidiaries in the United States and/or other countries. SCILLC owns the rights to a number of patents, trademarks, copyrights, trade secrets, and other intellectual property. A listing of SCILLC's product/patent coverage may be accessed at www.onsemi.com/site/pdf/Patent-Marking.pdf. SCILLC reserves the right to make changes without further notice to any products herein. SCILLC makes no warranty, representation or guarantee regarding the suitability of its products for any particular purpose, nor does SCILLC assume any liability arising out of the application or use of any product or circuit, and specifically disclaims any and all liability, including without limitation special, consequential or incidental damages. "Typical" parameters which may be provided in SCILLC data sheets and/or specifications can and do vary in different applications and actual performance may vary over time. All operating parameters, including "Typicals" must be validated for each customer application by customer's technical experts. SCILLC does not convey any license under its patent rights nor the rights of others. SCILLC products are not designed, intended, or authorized for use as components in systems intended for surgical implant into the body, or other applications intended to support or sustain life, or for any other application in which the failure of the SCILLC product could create a situation where personal injury or death may occur. Should Buyer purchase or use SCILLC products for any such unintended or unauthorized application, Buyer shall indemnify and hold SCILLC and its officers, employees, subsidiaries, affiliates, and distributors harmless against all claims, costs, damages, and expenses, and reasonable attorney fees arising out of, directly or indirectly, any claim of personal injury or death associated with such unintended or unauthorized use, even if such claim alleges that SCILLC was negligent regarding the design or manufacture of the part. SCILLC is an Equal Opportunity/Affirmative Action Employer. This literature is subject to all applicable copyright laws and is not for resale in any manner.

PUBLICATION ORDERING INFORMATION

LITERATURE FULFILLMENT:
Literature Distribution Center for ON Semiconductor
P.O. Box 5163, Denver, Colorado 80217 USA
Phone: 303-675-2175 or 800-344-3860 Toll Free USA/Canada
Fax: 303-675-2176 or 800-344-3867 Toll Free USA/Canada
Email: orderlit@onsemi.com

N. American Technical Support: 800-282-9855 Toll Free
USA/Canada
Europe, Middle East and Africa Technical Support:
Phone: 421 33 790 2910
Japan Customer Focus Center
Phone: 81-3-5817-1050

ON Semiconductor Website: www.onsemi.com
Order Literature: <http://www.onsemi.com/orderlit>

For additional information, please contact your local Sales Representative

X-ON Electronics

Largest Supplier of Electrical and Electronic Components

Click to view similar products for [Encoders, Decoders, Multiplexers & Demultiplexers](#) *category:*

Click to view products by [ON Semiconductor](#) *manufacturer:*

Other Similar products are found below :

[MC74HC163ADTG](#) [74HC253N](#) [NLV74VHC1G01DFT1G](#) [TC74AC138P\(F\)](#) [NLV14051BDR2G](#) [NLV74HC238ADTR2G](#) [COMX-CAR-210](#)
[5962-8607001EA](#) [NTE74LS247](#) [5962-8756601EA](#) [SN74LS148N](#) [8CA3052APGGI8](#) [TC74VHC138F\(EL,K,F\)](#) [PI3B3251LE](#) [PI3B3251QE](#)
[NTE4028B](#) [NTE4514B](#) [NTE4515B](#) [NTE4543B](#) [NTE4547B](#) [NTE74LS249](#) [NLV74HC4851AMNTWG](#) [MC74LVX257DG](#)
[M74HCT4851ADWR2G](#) [AP4373AW5-7-01](#) [NL7SZ19DBVT1G](#) [MC74LVX257DTR2G](#) [74VHC4066AFT\(BJ\)](#) [74VHCT138AFT\(BJ\)](#)
[74HC158D.652](#) [74HC4052D\(BJ\)](#) [74VHC138MTC](#) [COMX-CAR-P1](#) [JM38510/65852BEA](#) [74VHC138MTCX](#) [74HC138D\(BJ\)](#)
[NL7SZ19DFT2G](#) [74AHCT138T16-13](#) [74LCX138FT\(AJ\)](#) [74LCX157FT\(AJ\)](#) [NL7SZ18MUR2G](#) [PCA9540BD,118](#) [QS3VH16233PAG8](#)
[SNJ54HC251J](#) [SN54LS139AJ](#) [SN74CBTLV3257PWG4](#) [SN74ALS156DR](#) [SN74AHCT139PWR](#) [74HC251D.652](#) [74HC257D.652](#)