

# MC74VHC126

## Quad Bus Buffer with 3-State Control Inputs

The MC74VHC126 is a high speed CMOS quad bus buffer fabricated with silicon gate CMOS technology. It achieves noninverting high speed operation similar to equivalent Bipolar Schottky TTL while maintaining CMOS low power dissipation.

The MC74VHC126 requires the 3-state control input (OE) to be set Low to place the output into high impedance.

The internal circuit is composed of three stages, including a buffer output which provides high noise immunity and stable output. The inputs tolerate voltages up to 7.0 V, allowing the interface of 5.0 V systems to 3.0 V systems.

- High Speed:  $t_{PD} = 3.8 \text{ ns}$  (Typ) at  $V_{CC} = 5.0 \text{ V}$
- Low Power Dissipation:  $I_{CC} = 4.0 \mu\text{A}$  (Max) at  $T_A = 25^\circ\text{C}$
- High Noise Immunity:  $V_{NIH} = V_{NIL} = 28\% V_{CC}$
- Power Down Protection Provided on Inputs
- Balanced Propagation Delays
- Designed for 2.0 V to 5.5 V Operating Range
- Low Noise:  $V_{OLP} = 0.8 \text{ V}$  (Max)
- Pin and Function Compatible with Other Standard Logic Families
- Latchup Performance Exceeds 300 mA
- ESD Performance: HBM > 2000 V; Machine Model > 200 V
- Chip Complexity: 72 FETs or 18 Equivalent Gates
- These Devices are Pb-Free and are RoHS Compliant



**ON Semiconductor®**

<http://onsemi.com>

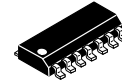

14-LEAD SOIC  
D SUFFIX  
CASE 751A



14-LEAD TSSOP  
DT SUFFIX  
CASE 948G

### PIN CONNECTIONS

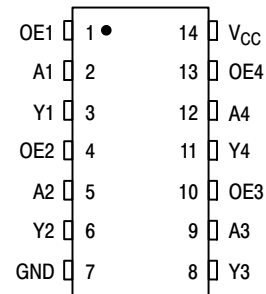

(Top View)

### ORDERING INFORMATION

| Device          | Package | Shipping        |
|-----------------|---------|-----------------|
| MC74VHC126DR2G  | SOIC    | 2500 Units/Reel |
| MC74VHC126DTR2G | TSSOP   | 2500 Units/Reel |

### DEVICE MARKING INFORMATION

See general marking information in the device marking section on page 7 of this data sheet.

# MC74VHC126

## Active-High Output Enables

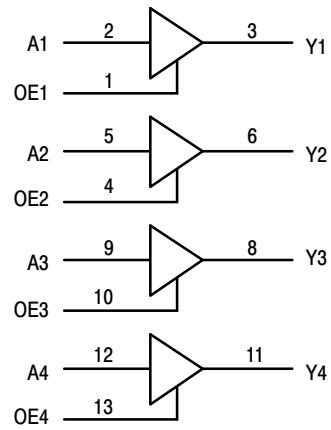

## FUNCTION TABLE

| VHC126 |    |        |
|--------|----|--------|
| Inputs |    | Output |
| A      | OE | Y      |
| H      | H  | H      |
| L      | H  | L      |
| X      | L  | Z      |

Figure 1. Logic Diagram

# MC74VHC126

## MAXIMUM RATINGS (Note 1)

| Symbol    | Parameter                                | Value                          | Unit        |    |
|-----------|--|--------------------------------|-------------|----|
| $V_{CC}$  | DC Supply Voltage                        | -0.5 to +7.0                   | V           |    |
| $V_{in}$  | DC Input Voltage                         | -0.5 to +7.0                   | V           |    |
| $V_{out}$ | DC Output Voltage                        | -0.5 to $V_{CC} + 0.5$         | V           |    |
| $I_{IK}$  | Input Diode Current                      | -20                            | mA          |    |
| $I_{OK}$  | Output Diode Current                     | $\pm 20$                       | mA          |    |
| $I_{out}$ | DC Output Current, per Pin               | $\pm 25$                       | mA          |    |
| $I_{CC}$  | DC Supply Current, $V_{CC}$ and GND Pins | $\pm 50$                       | mA          |    |
| $P_D$     | Power Dissipation in Still Air (Note 2)  | SOIC Packages<br>TSSOP Package | 500<br>450  | mW |
| $T_{stg}$ | Storage Temperature                      | -65 to +150                    | $^{\circ}C$ |    |

1. Maximum Ratings are those values beyond which damage to the device may occur. Exposure to these conditions or conditions beyond those indicated may adversely affect device reliability. Functional operation under absolute maximum-rated conditions is not implied. Functional operation should be restricted to the Recommended Operating Conditions.

2. Derating – SOIC Packages: - 7.0 mW/ $^{\circ}C$  from 65 $^{\circ}$  to 125 $^{\circ}C$   
TSSOP Package: - 6.1 mW/ $^{\circ}C$  from 65 $^{\circ}$  to 125 $^{\circ}C$

## RECOMMENDED OPERATING CONDITIONS

| Symbol     | Parameter                                | Min  | Max      | Unit        |
|------------|--|--|----------|-------------|
| $V_{CC}$   | DC Supply Voltage                        | 2.0  | 5.5      | V           |
| $V_{in}$   | DC Input Voltage                         | 0  | 5.5      | V           |
| $V_{out}$  | DC Output Voltage                        | 0  | $V_{CC}$ | V           |
| $T_A$      | Operating Temperature, All Package Types | -55  | +125     | $^{\circ}C$ |
| $t_r, t_f$ | Input Rise and Fall Time                 | $V_{CC} = 3.3 V \pm 0.3 V$<br>$V_{CC} = 5.0 V \pm 0.5 V$ | 0<br>100 | ns/V        |
|            |  | 0  | 20       |             |

# MC74VHC126

## DC ELECTRICAL CHARACTERISTICS

| Symbol          | Parameter   | Test Conditions  | V <sub>CC</sub><br>(V)   | T <sub>A</sub> = 25°C      |                   |                            | T <sub>A</sub> ≤ 85°C      |                            | T <sub>A</sub> ≤ 125°C     |                            | Unit |
|-----------------|---|--|--------------------------|----------------------------|-------------------|----------------------------|----------------------------|----------------------------|----------------------------|----------------------------|------|
|                 |   |  |                          | Min                        | Typ               | Max                        | Min                        | Max                        | Min                        | Max                        |      |
| V <sub>IH</sub> | Minimum High-Level Input Voltage  |  | 2.0<br>3.0<br>4.5<br>5.5 | 1.5<br>2.1<br>3.15<br>3.85 |                   |                            | 1.5<br>2.1<br>3.15<br>3.85 |                            | 1.5<br>2.1<br>3.15<br>3.85 | V                          |      |
| V <sub>IL</sub> | Maximum Low-Level Input Voltage   |  | 2.0<br>3.0<br>4.5<br>5.5 |                            |                   | 0.5<br>0.9<br>1.35<br>1.65 |                            | 0.5<br>0.9<br>1.35<br>1.65 |                            | 0.5<br>0.9<br>1.35<br>1.65 | V    |
| V <sub>OH</sub> | Minimum High-Level Output Voltage<br>V <sub>IN</sub> = V <sub>IH</sub> or V <sub>IL</sub> | V <sub>IN</sub> = V <sub>IH</sub> or V <sub>IL</sub><br>I <sub>OH</sub> = -50 μA                               | 2.0<br>3.0<br>4.5        | 1.9<br>2.9<br>4.4          | 2.0<br>3.0<br>4.5 |                            | 1.9<br>2.9<br>4.4          |                            | 1.9<br>2.9<br>4.4          | V                          |      |
|                 |   | V <sub>IN</sub> = V <sub>IH</sub> or V <sub>IL</sub><br>I <sub>OH</sub> = -4.0 mA<br>I <sub>OH</sub> = -8.0 mA | 3.0<br>4.5               | 2.58<br>3.94               |                   |                            | 2.48<br>3.80               |                            | 2.34<br>3.66               | V                          |      |
| V <sub>OL</sub> | Maximum Low-Level Output Voltage<br>V <sub>IN</sub> = V <sub>IH</sub> or V <sub>IL</sub>  | V <sub>IN</sub> = V <sub>IH</sub> or V <sub>IL</sub><br>I <sub>OL</sub> = 50 μA                                | 2.0<br>3.0<br>4.5        |                            | 0.0<br>0.0<br>0.0 | 0.1<br>0.1<br>0.1          |                            | 0.1<br>0.1<br>0.1          |                            | 0.1<br>0.1<br>0.1          | V    |
|                 |   | V <sub>IN</sub> = V <sub>IH</sub> or V <sub>IL</sub><br>I <sub>OL</sub> = 4.0 mA<br>I <sub>OL</sub> = 8.0 mA   | 3.0<br>4.5               |                            |                   | 0.36<br>0.36               | 0.44<br>0.44               |                            | 0.52<br>0.52               | V                          |      |
| I <sub>OZ</sub> | Maximum 3-State Leakage Current   | V <sub>IN</sub> = V <sub>IH</sub> or V <sub>IL</sub><br>V <sub>OUT</sub> = V <sub>CC</sub> or GND              | 5.5                      |                            |                   | ±0.25                      |                            | ±2.5                       |                            | ±2.5                       | μA   |
| I <sub>IN</sub> | Maximum Input Leakage Current   | V <sub>IN</sub> = 5.5 V or GND   | 0 to 5.5                 |                            |                   | ±0.1                       |                            | ±1.0                       |                            | ±1.0                       | μA   |
| I <sub>CC</sub> | Maximum Quiescent Supply Current  | V <sub>IN</sub> = V <sub>CC</sub> or GND   | 5.5                      |                            |                   | 4.0                        |                            | 40                         |                            | 40                         | μA   |

# MC74VHC126

## AC ELECTRICAL CHARACTERISTICS (Input $t_r = t_f = 3.0$ ns)

| Symbol                     | Parameter   | Test Conditions                                 | $T_A = 25^\circ\text{C}$ |     |      | $T_A = \leq 85^\circ\text{C}$ |      | $T_A = \leq 125^\circ\text{C}$ |      | Unit |
|----------------------------|---|---|--------------------------|-----|------|-------------------------------|------|--------------------------------|------|------|
|                            |   |   | Min                      | Typ | Max  | Min                           | Max  | Min                            | Max  |      |
| $t_{PLH}$ ,<br>$t_{PHL}$   | Maximum Propagation Delay, A to Y                                       | $V_{CC} = 3.3 \pm 0.3$ V $C_L = 15$ pF          |                          | 5.6 | 8.0  | 1.0                           | 9.5  | 1.0                            | 12.0 | ns   |
|                            |   | $C_L = 50$ pF                                   |                          | 8.1 | 11.5 | 1.0                           | 13.0 | 1.0                            | 15.0 |      |
|                            |   | $V_{CC} = 5.0 \pm 0.5$ V $C_L = 15$ pF          |                          | 3.8 | 5.5  | 1.0                           | 6.5  | 1.0                            | 8.5  |      |
|                            |   | $C_L = 50$ pF                                   |                          | 5.3 | 7.5  | 1.0                           | 8.5  | 1.0                            | 10.5 |      |
| $t_{PZL}$ ,<br>$t_{PZH}$   | Maximum Output Enable Time, OE to Y                                     | $V_{CC} = 3.3 \pm 0.3$ V $C_L = 15$ pF          |                          | 5.4 | 8.0  | 1.0                           | 9.5  | 1.0                            | 11.5 | ns   |
|                            |   | $R_L = 1.0$ k $\Omega$ $C_L = 50$ pF            |                          | 7.9 | 11.5 | 1.0                           | 13.0 | 1.0                            | 15.0 |      |
|                            |   | $V_{CC} = 5.0 \pm 0.5$ V $C_L = 15$ pF          |                          | 3.6 | 5.1  | 1.0                           | 6.0  | 1.0                            | 7.5  |      |
|                            |   | $R_L = 1.0$ k $\Omega$ $C_L = 50$ pF            |                          | 5.1 | 7.1  | 1.0                           | 8.0  | 1.0                            | 9.5  |      |
| $t_{PLZ}$ ,<br>$t_{PHZ}$   | Maximum Output Disable Time, OE to Y                                    | $V_{CC} = 3.3 \pm 0.3$ V $C_L = 50$ pF          |                          | 9.5 | 13.2 | 1.0                           | 15.0 | 1.0                            | 18.0 | ns   |
|                            |   | $R_L = 1.0$ k $\Omega$                          |                          |     |      |                               |      |                                |      |      |
|                            |   | $V_{CC} = 5.0 \pm 0.5$ V $C_L = 50$ pF          |                          | 6.1 | 8.8  | 1.0                           | 10.0 | 1.0                            | 12.0 |      |
|                            |   | $R_L = 1.0$ k $\Omega$                          |                          |     |      |                               |      |                                |      |      |
| $t_{OSLH}$ ,<br>$t_{OSHL}$ | Output-to-Output Skew   | $V_{CC} = 3.3 \pm 0.3$ V $C_L = 50$ pF (Note 3) |                          |     | 1.5  |                               | 1.5  |                                | 1.5  | ns   |
|                            |   | $V_{CC} = 5.0 \pm 0.5$ V $C_L = 50$ pF (Note 3) |                          |     | 1.0  |                               | 1.0  |                                | 1.0  |      |
| $C_{in}$                   | Maximum Input Capacitance   |   |                          | 4.0 | 10   |                               | 10   |                                | 10   | pF   |
| $C_{out}$                  | Maximum Three-State Output Capacitance (Output in High Impedance State) |   |                          | 6.0 |      |                               |      |                                |      | pF   |

| $C_{PD}$ | Power Dissipation Capacitance (Note 4) | Typical @ 25°C, $V_{CC} = 5.0$ V |  | pF |
|----------|--|----------------------------------|--|----|
|          |  | 15                               |  |    |
|          |  |                                  |  |    |

3. Parameter guaranteed by design.  $t_{OSLH} = |t_{PLHm} - t_{PLHn}|$ ,  $t_{OSHL} = |t_{PHLm} - t_{PHLn}|$ .

4.  $C_{PD}$  is defined as the value of the internal equivalent capacitance which is calculated from the operating current consumption without load. Average operating current can be obtained by the equation:  $I_{CC(OPR)} = C_{PD} \cdot V_{CC} \cdot f_{in} + I_{CC}/4$  (per buffer).  $C_{PD}$  is used to determine the no-load dynamic power consumption;  $P_D = C_{PD} \cdot V_{CC}^2 \cdot f_{in} + I_{CC} \cdot V_{CC}$ .

## NOISE CHARACTERISTICS (Input $t_r = t_f = 3.0$ ns, $C_L = 50$ pF, $V_{CC} = 5.0$ V)

| Symbol    | Characteristic                           | $T_A = 25^\circ\text{C}$ |       | Unit |
|-----------|--|--------------------------|-------|------|
|           |  | Typ                      | Max   |      |
| $V_{OLP}$ | Quiet Output Maximum Dynamic $V_{OL}$    | 0.3                      | 0.8   | V    |
| $V_{OLV}$ | Quiet Output Minimum Dynamic $V_{OL}$    | - 0.3                    | - 0.8 | V    |
| $V_{IHD}$ | Minimum High Level Dynamic Input Voltage |                          | 3.5   | V    |
| $V_{ILD}$ | Maximum Low Level Dynamic Input Voltage  |                          | 1.5   | V    |

# MC74VHC126

## SWITCHING WAVEFORMS

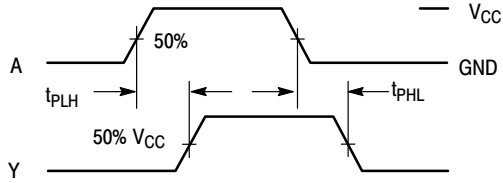

Figure 2.

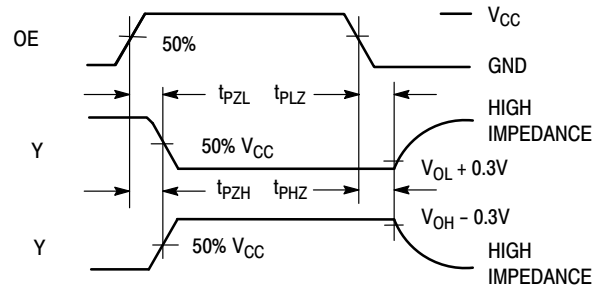
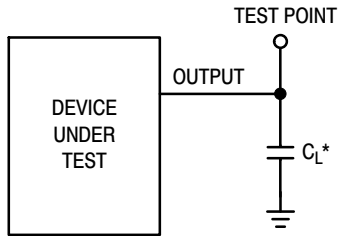
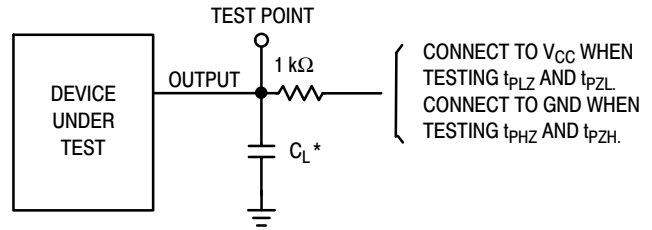

Figure 3.



\*Includes all probe and jig capacitance

Figure 4. Test Circuit



\*Includes all probe and jig capacitance

Figure 5. Test Circuit

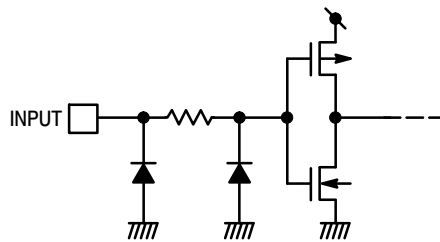
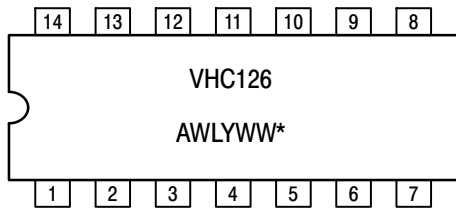

Figure 6. Input Equivalent Circuit

# MC74VHC126

## MARKING DIAGRAMS



**14-LEAD SOIC  
D SUFFIX  
CASE 751A**

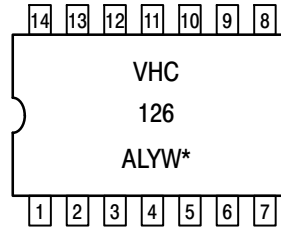

**14-LEAD TSSOP  
DT SUFFIX  
CASE 948G**

\*See Applications Note #AND8004/D for date code and traceability information.

# MECHANICAL CASE OUTLINE PACKAGE DIMENSIONS

ON Semiconductor®



SCALE 1:1

SOIC-14 NB  
CASE 751A-03  
ISSUE L

DATE 03 FEB 2016

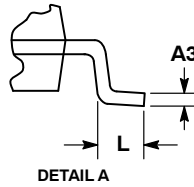

NOTES:

1. DIMENSIONING AND TOLERANCING PER ASME Y14.5M, 1994.
2. CONTROLLING DIMENSION: MILLIMETERS.
3. DIMENSION b DOES NOT INCLUDE DAMBAR PROTRUSION. ALLOWABLE PROTRUSION SHALL BE 0.13 TOTAL IN EXCESS OF AT MAXIMUM MATERIAL CONDITION.
4. DIMENSIONS D AND E DO NOT INCLUDE MOLD PROTRUSIONS.
5. MAXIMUM MOLD PROTRUSION 0.15 PER SIDE.

| DIM | MILLIMETERS |      | INCHES    |       |
|-----|-------------|------|-----------|-------|
|     | MIN         | MAX  | MIN       | MAX   |
| A   | 1.35        | 1.75 | 0.054     | 0.068 |
| A1  | 0.10        | 0.25 | 0.004     | 0.010 |
| A3  | 0.19        | 0.25 | 0.008     | 0.010 |
| b   | 0.35        | 0.49 | 0.014     | 0.019 |
| D   | 8.55        | 8.75 | 0.337     | 0.344 |
| E   | 3.80        | 4.00 | 0.150     | 0.157 |
| e   | 1.27 BSC    |      | 0.050 BSC |       |
| H   | 5.80        | 6.20 | 0.228     | 0.244 |
| h   | 0.25        | 0.50 | 0.010     | 0.019 |
| L   | 0.40        | 1.25 | 0.016     | 0.049 |
| M   | 0°          | 7°   | 0°        | 7°    |

SOLDERING FOOTPRINT\*



DIMENSIONS: MILLIMETERS

\*For additional information on our Pb-Free strategy and soldering details, please download the ON Semiconductor Soldering and Mounting Techniques Reference Manual, SOLDERRM/D.

GENERIC MARKING DIAGRAM\*



- XXXXXX = Specific Device Code
- A = Assembly Location
- WL = Wafer Lot
- Y = Year
- WW = Work Week
- G = Pb-Free Package

\*This information is generic. Please refer to device data sheet for actual part marking. Pb-Free indicator, "G" or microdot "▪", may or may not be present.

STYLES ON PAGE 2

|                  |             |  |
|------------------|-------------|--|
| DOCUMENT NUMBER: | 98ASB42565B | Electronic versions are uncontrolled except when accessed directly from the Document Repository. Printed versions are uncontrolled except when stamped "CONTROLLED COPY" in red. |
| DESCRIPTION:     | SOIC-14 NB  | PAGE 1 OF 2  |

ON Semiconductor and ON are trademarks of Semiconductor Components Industries, LLC dba ON Semiconductor or its subsidiaries in the United States and/or other countries. ON Semiconductor reserves the right to make changes without further notice to any products herein. ON Semiconductor makes no warranty, representation or guarantee regarding the suitability of its products for any particular purpose, nor does ON Semiconductor assume any liability arising out of the application or use of any product or circuit, and specifically disclaims any and all liability, including without limitation special, consequential or incidental damages. ON Semiconductor does not convey any license under its patent rights nor the rights of others.



**SOIC-14**  
**CASE 751A-03**  
**ISSUE L**

DATE 03 FEB 2016

STYLE 1:  
 PIN 1. COMMON CATHODE  
 2. ANODE/CATHODE  
 3. ANODE/CATHODE  
 4. NO CONNECTION  
 5. ANODE/CATHODE  
 6. NO CONNECTION  
 7. ANODE/CATHODE  
 8. ANODE/CATHODE  
 9. ANODE/CATHODE  
 10. NO CONNECTION  
 11. ANODE/CATHODE  
 12. ANODE/CATHODE  
 13. NO CONNECTION  
 14. COMMON ANODE

STYLE 2:  
 CANCELLED

STYLE 3:  
 PIN 1. NO CONNECTION  
 2. ANODE  
 3. ANODE  
 4. NO CONNECTION  
 5. ANODE  
 6. NO CONNECTION  
 7. ANODE  
 8. ANODE  
 9. ANODE  
 10. NO CONNECTION  
 11. ANODE  
 12. ANODE  
 13. NO CONNECTION  
 14. COMMON CATHODE

STYLE 4:  
 PIN 1. NO CONNECTION  
 2. CATHODE  
 3. CATHODE  
 4. NO CONNECTION  
 5. CATHODE  
 6. NO CONNECTION  
 7. CATHODE  
 8. CATHODE  
 9. CATHODE  
 10. NO CONNECTION  
 11. CATHODE  
 12. CATHODE  
 13. NO CONNECTION  
 14. COMMON ANODE

STYLE 5:  
 PIN 1. COMMON CATHODE  
 2. ANODE/CATHODE  
 3. ANODE/CATHODE  
 4. ANODE/CATHODE  
 5. ANODE/CATHODE  
 6. NO CONNECTION  
 7. COMMON ANODE  
 8. COMMON CATHODE  
 9. ANODE/CATHODE  
 10. ANODE/CATHODE  
 11. ANODE/CATHODE  
 12. ANODE/CATHODE  
 13. NO CONNECTION  
 14. COMMON ANODE

STYLE 6:  
 PIN 1. CATHODE  
 2. CATHODE  
 3. CATHODE  
 4. CATHODE  
 5. CATHODE  
 6. CATHODE  
 7. CATHODE  
 8. ANODE  
 9. ANODE  
 10. ANODE  
 11. ANODE  
 12. ANODE  
 13. ANODE  
 14. ANODE

STYLE 7:  
 PIN 1. ANODE/CATHODE  
 2. COMMON ANODE  
 3. COMMON CATHODE  
 4. ANODE/CATHODE  
 5. ANODE/CATHODE  
 6. ANODE/CATHODE  
 7. ANODE/CATHODE  
 8. ANODE/CATHODE  
 9. ANODE/CATHODE  
 10. ANODE/CATHODE  
 11. COMMON CATHODE  
 12. COMMON ANODE  
 13. ANODE/CATHODE  
 14. ANODE/CATHODE

STYLE 8:  
 PIN 1. COMMON CATHODE  
 2. ANODE/CATHODE  
 3. ANODE/CATHODE  
 4. NO CONNECTION  
 5. ANODE/CATHODE  
 6. ANODE/CATHODE  
 7. COMMON ANODE  
 8. COMMON ANODE  
 9. ANODE/CATHODE  
 10. ANODE/CATHODE  
 11. NO CONNECTION  
 12. ANODE/CATHODE  
 13. ANODE/CATHODE  
 14. COMMON CATHODE

|                         |                    |   |
|-------------------------|--------------------|---|
| <b>DOCUMENT NUMBER:</b> | <b>98ASB42565B</b> | Electronic versions are uncontrolled except when accessed directly from the Document Repository.<br>Printed versions are uncontrolled except when stamped "CONTROLLED COPY" in red. |
| <b>DESCRIPTION:</b>     | <b>SOIC-14 NB</b>  | <b>PAGE 2 OF 2</b>  |

ON Semiconductor and  are trademarks of Semiconductor Components Industries, LLC dba ON Semiconductor or its subsidiaries in the United States and/or other countries. ON Semiconductor reserves the right to make changes without further notice to any products herein. ON Semiconductor makes no warranty, representation or guarantee regarding the suitability of its products for any particular purpose, nor does ON Semiconductor assume any liability arising out of the application or use of any product or circuit, and specifically disclaims any and all liability, including without limitation special, consequential or incidental damages. ON Semiconductor does not convey any license under its patent rights nor the rights of others.

# MECHANICAL CASE OUTLINE

## PACKAGE DIMENSIONS

ON Semiconductor®



**TSSOP-14 WB**  
CASE 948G  
ISSUE C

DATE 17 FEB 2016

SCALE 2:1



**NOTES:**

- DIMENSIONING AND TOLERANCING PER ANSI Y14.5M, 1982.
- CONTROLLING DIMENSION: MILLIMETER.
- DIMENSION A DOES NOT INCLUDE MOLD FLASH, PROTRUSIONS OR GATE BURRS. MOLD FLASH OR GATE BURRS SHALL NOT EXCEED 0.15 (0.006) PER SIDE.
- DIMENSION B DOES NOT INCLUDE INTERLEAD FLASH OR PROTRUSION. INTERLEAD FLASH OR PROTRUSION SHALL NOT EXCEED 0.25 (0.010) PER SIDE.
- DIMENSION K DOES NOT INCLUDE DAMBAR PROTRUSION. ALLOWABLE DAMBAR PROTRUSION SHALL BE 0.08 (0.003) TOTAL IN EXCESS OF THE K DIMENSION AT MAXIMUM MATERIAL CONDITION.
- TERMINAL NUMBERS ARE SHOWN FOR REFERENCE ONLY.
- DIMENSION A AND B ARE TO BE DETERMINED AT DATUM PLANE -W-.

| DIM | MILLIMETERS |      | INCHES    |       |
|-----|-------------|------|-----------|-------|
|     | MIN         | MAX  | MIN       | MAX   |
| A   | 4.90        | 5.10 | 0.193     | 0.200 |
| B   | 4.30        | 4.50 | 0.169     | 0.177 |
| C   | ---         | 1.20 | ---       | 0.047 |
| D   | 0.05        | 0.15 | 0.002     | 0.006 |
| F   | 0.50        | 0.75 | 0.020     | 0.030 |
| G   | 0.65 BSC    |      | 0.026 BSC |       |
| H   | 0.50        | 0.60 | 0.020     | 0.024 |
| J   | 0.09        | 0.20 | 0.004     | 0.008 |
| J1  | 0.09        | 0.16 | 0.004     | 0.006 |
| K   | 0.19        | 0.30 | 0.007     | 0.012 |
| K1  | 0.19        | 0.25 | 0.007     | 0.010 |
| L   | 6.40 BSC    |      | 0.252 BSC |       |
| M   | 0°          | 8°   | 0°        | 8°    |

**GENERIC MARKING DIAGRAM\***



- A = Assembly Location
- L = Wafer Lot
- Y = Year
- W = Work Week
- = Pb-Free Package

(Note: Microdot may be in either location)

\*This information is generic. Please refer to device data sheet for actual part marking. Pb-Free indicator, "G" or microdot "▪", may or may not be present.

**SOLDERING FOOTPRINT**



|                         |                    |  |
|-------------------------|--------------------|--|
| <b>DOCUMENT NUMBER:</b> | <b>98ASH70246A</b> | Electronic versions are uncontrolled except when accessed directly from the Document Repository. Printed versions are uncontrolled except when stamped "CONTROLLED COPY" in red. |
| <b>DESCRIPTION:</b>     | <b>TSSOP-14 WB</b> | <b>PAGE 1 OF 1</b>   |

ON Semiconductor and ON are trademarks of Semiconductor Components Industries, LLC dba ON Semiconductor or its subsidiaries in the United States and/or other countries. ON Semiconductor reserves the right to make changes without further notice to any products herein. ON Semiconductor makes no warranty, representation or guarantee regarding the suitability of its products for any particular purpose, nor does ON Semiconductor assume any liability arising out of the application or use of any product or circuit, and specifically disclaims any and all liability, including without limitation special, consequential or incidental damages. ON Semiconductor does not convey any license under its patent rights nor the rights of others.

**onsemi**, **Onsemi**, and other names, marks, and brands are registered and/or common law trademarks of Semiconductor Components Industries, LLC dba "**onsemi**" or its affiliates and/or subsidiaries in the United States and/or other countries. **onsemi** owns the rights to a number of patents, trademarks, copyrights, trade secrets, and other intellectual property. A listing of **onsemi**'s product/patent coverage may be accessed at [www.onsemi.com/site/pdf/Patent-Marking.pdf](http://www.onsemi.com/site/pdf/Patent-Marking.pdf). **onsemi** reserves the right to make changes at any time to any products or information herein, without notice. The information herein is provided "as-is" and **onsemi** makes no warranty, representation or guarantee regarding the accuracy of the information, product features, availability, functionality, or suitability of its products for any particular purpose, nor does **onsemi** assume any liability arising out of the application or use of any product or circuit, and specifically disclaims any and all liability, including without limitation special, consequential or incidental damages. Buyer is responsible for its products and applications using **onsemi** products, including compliance with all laws, regulations and safety requirements or standards, regardless of any support or applications information provided by **onsemi**. "Typical" parameters which may be provided in **onsemi** data sheets and/or specifications can and do vary in different applications and actual performance may vary over time. All operating parameters, including "Typicals" must be validated for each customer application by customer's technical experts. **onsemi** does not convey any license under any of its intellectual property rights nor the rights of others. **onsemi** products are not designed, intended, or authorized for use as a critical component in life support systems or any FDA Class 3 medical devices or medical devices with a same or similar classification in a foreign jurisdiction or any devices intended for implantation in the human body. Should Buyer purchase or use **onsemi** products for any such unintended or unauthorized application, Buyer shall indemnify and hold **onsemi** and its officers, employees, subsidiaries, affiliates, and distributors harmless against all claims, costs, damages, and expenses, and reasonable attorney fees arising out of, directly or indirectly, any claim of personal injury or death associated with such unintended or unauthorized use, even if such claim alleges that **onsemi** was negligent regarding the design or manufacture of the part. **onsemi** is an Equal Opportunity/Affirmative Action Employer. This literature is subject to all applicable copyright laws and is not for resale in any manner.

## PUBLICATION ORDERING INFORMATION

### LITERATURE FULFILLMENT:

Email Requests to: [orderlit@onsemi.com](mailto:orderlit@onsemi.com)

**onsemi Website:** [www.onsemi.com](http://www.onsemi.com)

### TECHNICAL SUPPORT

**North American Technical Support:**

Voice Mail: 1 800-282-9855 Toll Free USA/Canada

Phone: 011 421 33 790 2910

**Europe, Middle East and Africa Technical Support:**

Phone: 00421 33 790 2910

For additional information, please contact your local Sales Representative

## X-ON Electronics

Largest Supplier of Electrical and Electronic Components

*Click to view similar products for [Buffers & Line Drivers](#) category:*

*Click to view products by [ON Semiconductor](#) manufacturer:*

Other Similar products are found below :

[LXV200-024SW](#) [74AUP2G34FW3-7](#) [HEF4043BP](#) [NL17SG125DFT2G](#) [NLU1GT126CMUTCG](#) [CD4041UBE](#) [54FCT240CTDB](#)  
[74HCT540N](#) [DS14C88N](#) [070519XB](#) [NL17SZ07P5T5G](#) [74LVC2G17FW4-7](#) [CD4502BE](#) [5962-8982101PA](#) [61446R00](#) [74LVCE1G126FZ4-7](#)  
[NL17SH17P5T5G](#) [74HCT126T14-13](#) [74LVC2G34FW4-7](#) [74VHC9126FT\(BJ\)](#) [RHRXH162244K1](#) [74AUP1G34FW5-7](#) [74LVC1G126FW4-7](#)  
[74LVC2G126RA3-7](#) [74LVCE1G125FZ4-7](#) [74AUP1G126FW5-7](#) [54FCT240TLB](#) [74LVCE1G07FZ4-7](#) [NLX3G16DMUTCG](#)  
[NLX2G06AMUTCG](#) [LE87100NQCT](#) [LE87285NQC](#) [LE87290YQC](#) [LE87290YQCT](#) [74AUP1G125FW5-7](#) [NLU2G16CMUTCG](#)  
[MC74LCX244MN2TWG](#) [NL17SG17P5T5G](#) [NLV74HC125ADR2G](#) [NLVHCT245ADTR2G](#) [NLVVHC1G126DFT2G](#) [EL5623IRZ](#)  
[ISL1539IRZ-T13](#) [MC100EP17MNG](#) [MC74HCT365ADR2G](#) [MC74LCX244ADTR2G](#) [NL27WZ126US](#) [NL37WZ16US](#) [NLU1G07MUTCG](#)  
[NLU2G07MUTCG](#)