



MCH6351

P-Channel Power MOSFET -12V, -9A, 16.9mΩ, Single MCPH6

ON Semiconductor®
<http://onsemi.com>

Features

- On-resistance $R_{DS(on)} = 14\text{m}\Omega$ (typ.)
- Halogen free compliance
- 1.5V drive
- Protection diode in

Specifications

Absolute Maximum Ratings at $T_a = 25^\circ\text{C}$

Parameter	Symbol	Conditions	Ratings	Unit
Drain to Source Voltage	V_{DS}		-12	V
Gate to Source Voltage	V_{GS}		± 10	V
Drain Current (DC)	I_D		-9	A
Drain Current (Pulse)	I_{DP}	$PW \leq 10\mu\text{s}$, duty cycle $\leq 1\%$	-36	A
Allowable Power Dissipation	P_D	When mounted on ceramic substrate ($1500\text{mm}^2 \times 0.8\text{mm}$)	1.5	W
Channel Temperature	T_{ch}		150	$^\circ\text{C}$
Storage Temperature	T_{stg}		-55 to +150	$^\circ\text{C}$

Stresses exceeding Maximum Ratings may damage the device. Maximum Ratings are stress ratings only. Functional operation above the Recommended Operating Conditions is not implied. Extended exposure to stresses above the Recommended Operating Conditions may affect device reliability.

Package Dimensions

unit : mm (typ)

7022A-009

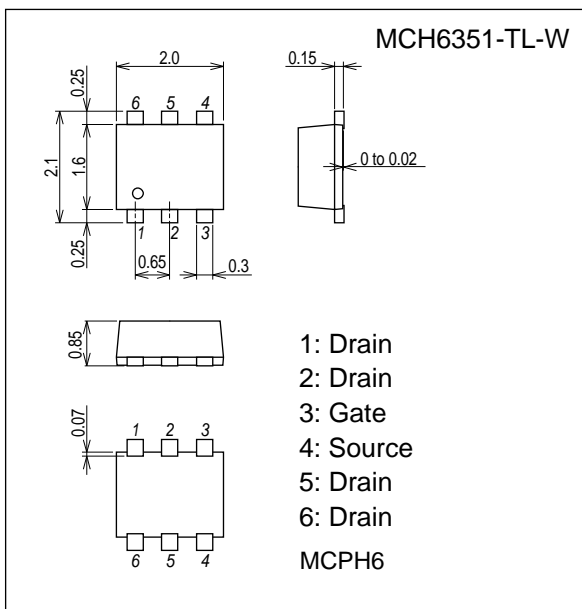

Ordering & Package Information

Device	Package	Shipping	note
MCH6351-TL-W	MCPH6 SC-88, SOT-363	3,000 pcs. / reel	Pb-Free and Halogen Free

Packing Type: TL

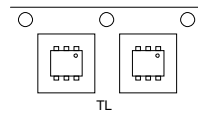

Marking

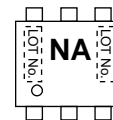

Electrical Connection

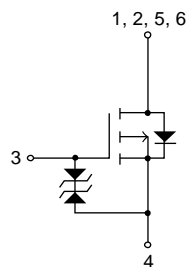

MCH6351

Electrical Characteristics at Ta = 25°C

Parameter	Symbol	Conditions	Ratings			Unit
			min	typ	max	
Drain to Source Breakdown Voltage	$V_{(BR)DSS}$	$I_D = -1\text{mA}, V_{GS} = 0\text{V}$	-12			V
Zero-Gate Voltage Drain Current	I_{DSS}	$V_{DS} = -12\text{V}, V_{GS} = 0\text{V}$			-1	μA
Gate to Source Leakage Current	I_{GSS}	$V_{GS} = \pm 8\text{V}, V_{DS} = 0\text{V}$			± 10	μA
Cutoff Voltage	$V_{GS(off)}$	$V_{DS} = -6\text{V}, I_D = -1\text{mA}$	-0.4		-1.3	V
Forward Transfer Admittance	$ y_{fs} $	$V_{DS} = -6\text{V}, I_D = -4.5\text{A}$		16.5		S
Static Drain to Source On-State Resistance	$R_{DS(on)1}$	$I_D = -4.5\text{A}, V_{GS} = -4.5\text{V}$		14	16.9	$\text{m}\Omega$
	$R_{DS(on)2}$	$I_D = -2.0\text{A}, V_{GS} = -2.5\text{V}$		19	24	$\text{m}\Omega$
	$R_{DS(on)3}$	$I_D = -1.0\text{A}, V_{GS} = -1.8\text{V}$		28	40	$\text{m}\Omega$
	$R_{DS(on)4}$	$I_D = -1.0\text{A}, V_{GS} = -1.5\text{V}$		37	74	$\text{m}\Omega$
Input Capacitance	C_{iss}	$V_{DS} = -6\text{V}, f = 1\text{MHz}$		2200		pF
Output Capacitance	C_{oss}			350		pF
Reverse Transfer Capacitance	C_{rss}			320		pF
Turn-ON Delay Time	$t_d(on)$		See specified Test Circuit.		12.3	
Rise Time	t_r			89		ns
Turn-OFF Delay Time	$t_d(off)$			260		ns
Fall Time	t_f			122		ns
Total Gate Charge	Q_g	$V_{DS} = -6\text{V}, V_{GS} = -4.5\text{V}, I_D = -9\text{A}$			20.5	
Gate to Source Charge	Q_{gs}			4.2		nC
Gate to Drain "Miller" Charge	Q_{gd}			3.2		nC
Diode Forward Voltage	V_{SD}	$I_S = -9\text{A}, V_{GS} = 0\text{V}$		-0.83	-1.2	V

Switching Time Test Circuit

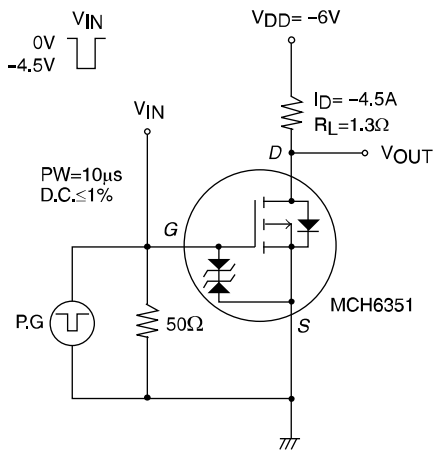

MCH6351

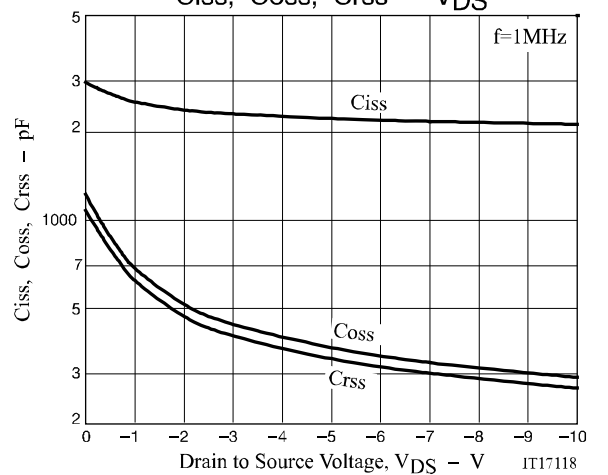
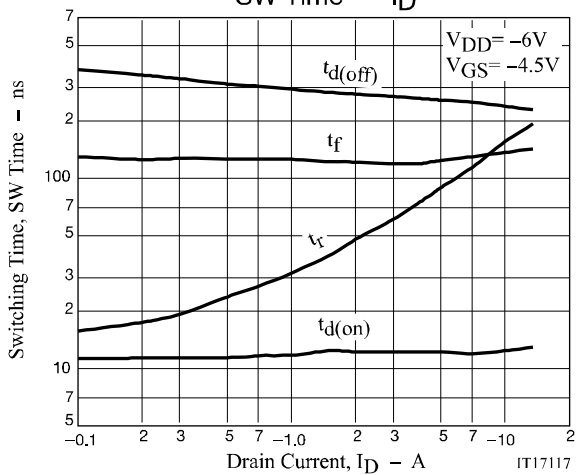
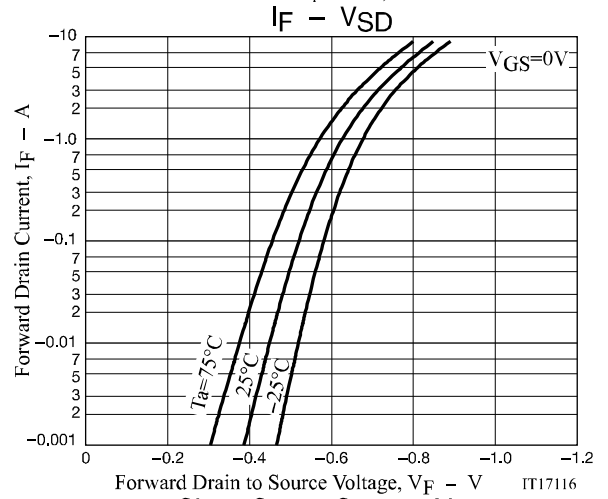
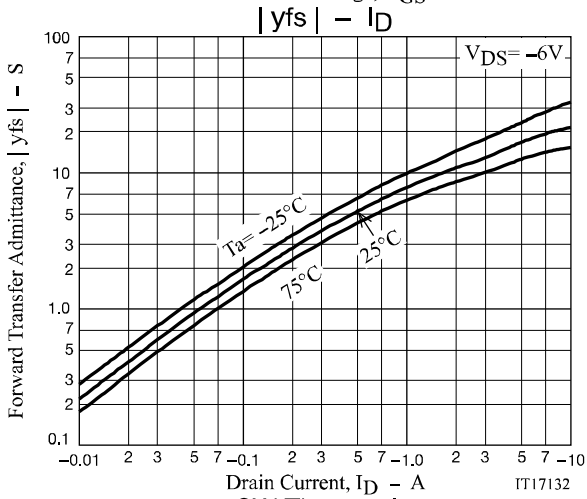
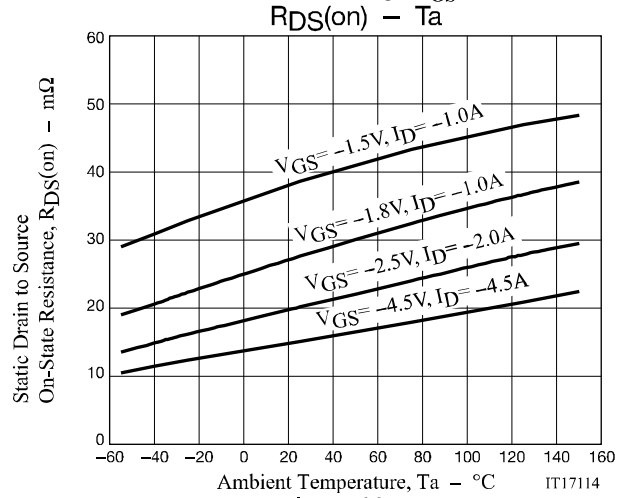
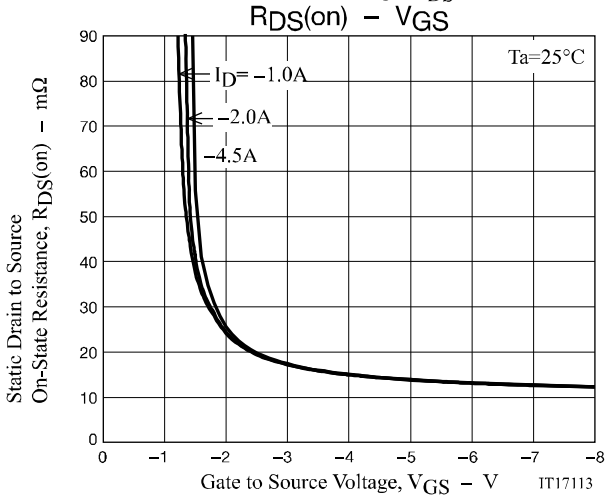
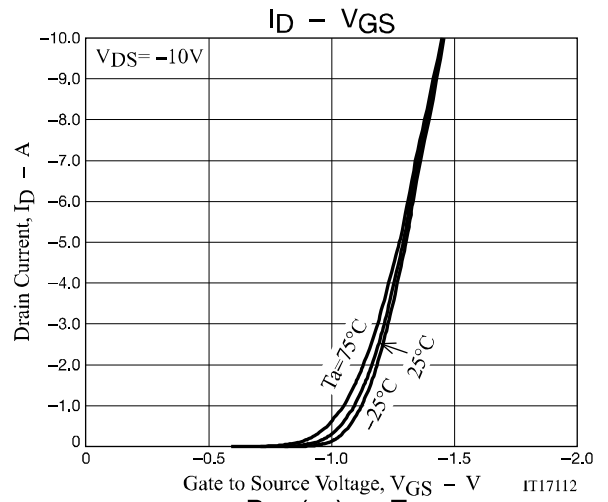
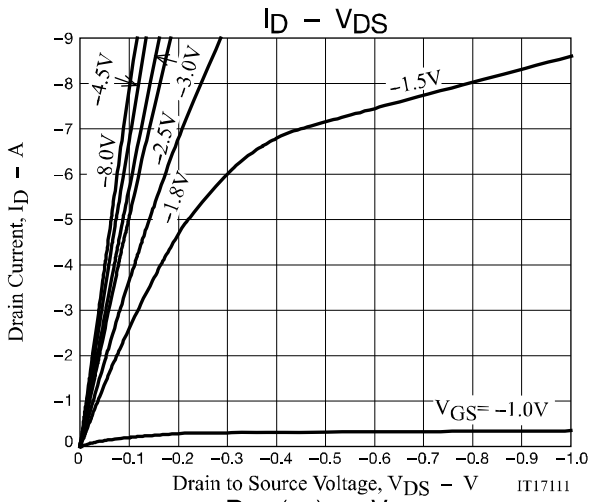

MCH6351

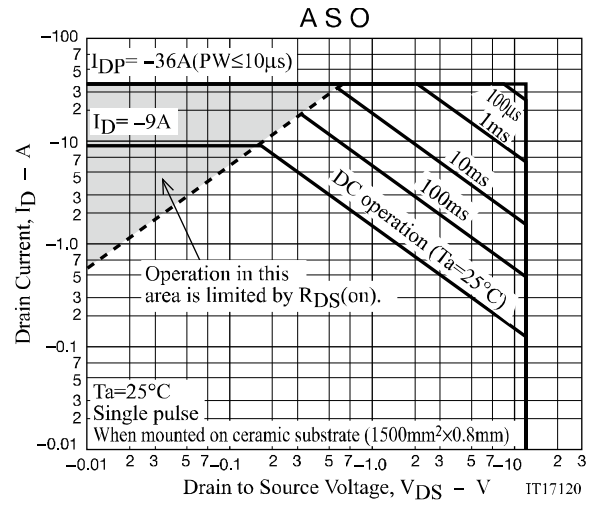
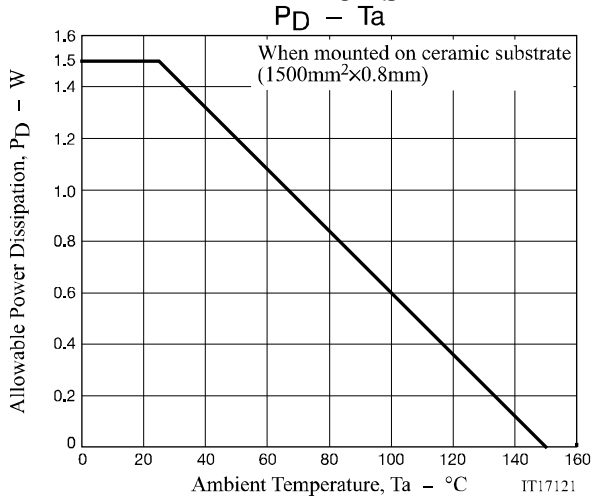
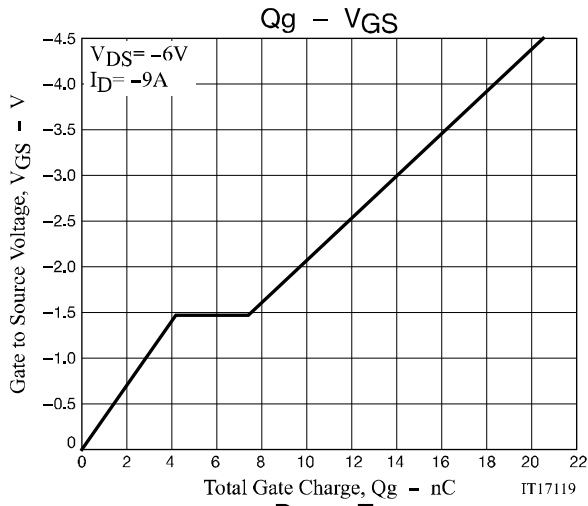

Note on usage : Since the MCH6351 is a MOSFET product, please avoid using this device in the vicinity of highly charged objects.

ON Semiconductor and the ON logo are registered trademarks of Semiconductor Components Industries, LLC (SCILLC). SCILLC owns the rights to a number of patents, trademarks, copyrights, trade secrets, and other intellectual property. A listing of SCILLC's product/patent coverage may be accessed at www.onsemi.com/site/pdf/Patent-Marking.pdf. SCILLC reserves the right to make changes without further notice to any products herein. SCILLC makes no warranty, representation or guarantee regarding the suitability of its products for any particular purpose, nor does SCILLC assume any liability arising out of the application or use of any product or circuit, and specifically disclaims any and all liability, including without limitation special, consequential or incidental damages. "Typical" parameters which may be provided in SCILLC data sheets and/or specifications can and do vary in different applications and actual performance may vary over time. All operating parameters, including "Typicals" must be validated for each customer application by customer's technical experts. SCILLC does not convey any license under its patent rights nor the rights of others. SCILLC products are not designed, intended, or authorized for use as components in systems intended for surgical implant into the body, or other applications intended to support or sustain life, or for any other application in which the failure of the SCILLC product could create a situation where personal injury or death may occur. Should Buyer purchase or use SCILLC products for any such unintended or unauthorized application, Buyer shall indemnify and hold SCILLC and its officers, employees, subsidiaries, affiliates, and distributors harmless against all claims, costs, damages, and expenses, and reasonable attorney fees arising out of, directly or indirectly, any claim of personal injury or death associated with such unintended or unauthorized use, even if such claim alleges that SCILLC was negligent regarding the design or manufacture of the part. SCILLC is an Equal Opportunity/Affirmative Action Employer. This literature is subject to all applicable copyright laws and is not for resale in any manner.

X-ON Electronics

Largest Supplier of Electrical and Electronic Components

Click to view similar products for [MOSFET](#) category:

Click to view products by [ON Semiconductor](#) manufacturer:

Other Similar products are found below :

[614233C](#) [648584F](#) [IRFD120](#) [JANTX2N5237](#) [FCA20N60_F109](#) [FDZ595PZ](#) [2SK2545\(Q,T\)](#) [405094E](#) [423220D](#) [TPCC8103,L1Q\(CM](#)
[MIC4420CM-TR](#) [VN1206L](#) [SBVS138LT1G](#) [614234A](#) [715780A](#) [NTNS3166NZT5G](#) [SSM6J414TU,LF\(T](#) [751625C](#) [BUK954R8-60E](#)
[NTE6400](#) [SQJ402EP-T1-GE3](#) [2SK2614\(TE16L1,Q\)](#) [2N7002KW-FAI](#) [DMN1017UCP3-7](#) [EFC2J004NUZTDG](#) [ECH8691-TL-W](#)
[FCAB21350L1](#) [P85W28HP2F-7071](#) [DMN1053UCP4-7](#) [NTE221](#) [NTE2384](#) [NTE2903](#) [NTE2941](#) [NTE2945](#) [NTE2946](#) [NTE2960](#) [NTE2967](#)
[NTE2969](#) [NTE2976](#) [NTE455](#) [NTE6400A](#) [NTE2910](#) [NTE2916](#) [NTE2956](#) [NTE2911](#) [DMN2080UCB4-7](#) [TK10A80W,S4X\(S](#)
[SSM6P69NU,LF](#) [DMP22D4UFO-7B](#) [DMN1006UCA6-7](#)