

MJ11021 (PNP) MJ11022 (NPN)

Complementary Darlington Silicon Power Transistors

Complementary Darlington Silicon Power Transistors are designed for use as general purpose amplifiers, low frequency switching and motor control applications.

Features

- High dc Current Gain @ 10 Adc – $h_{FE} = 400$ Min (All Types)
- Collector–Emitter Sustaining Voltage
 $V_{CEO(sus)} = 250$ Vdc (Min) – MJ11022, 21
- Low Collector–Emitter Saturation
 $V_{CE(sat)} = 1.0$ V (Typ) @ $I_C = 5.0$ A
 $= 1.8$ V (Typ) @ $I_C = 10$ A
- 100% SOA Tested @ $V_{CE} = 44$ V
 $I_C = 4.0$ A
 $t = 250$ ms
- Pb–Free Packages are Available*

MAXIMUM RATINGS ($T_J = 25^\circ\text{C}$ unless otherwise noted)

Rating	Symbol	Value	Unit
Collector–Emitter Voltage	V_{CEO}	250	Vdc
Collector–Base Voltage	V_{CBO}	250	Vdc
Emitter–Base Voltage	V_{EBO}	50	Vdc
Collector Current – Continuous – Peak (Note 1)	I_C	15 30	Adc
Base Current	I_B	0.5	Adc
Total Power Dissipation @ $T_C = 25^\circ\text{C}$ Derate Above 25°C	P_D	175 1.16	W W/ $^\circ\text{C}$
Operating and Storage Junction Temperature Range	T_J, T_{stg}	-65 to $+175$ -65 to $+200$	$^\circ\text{C}$

THERMAL CHARACTERISTICS

Characteristic	Symbol	Max	Unit
Thermal Resistance, Junction–to–Case	$R_{\theta JC}$	0.86	$^\circ\text{C}/\text{W}$

Maximum ratings are those values beyond which device damage can occur. Maximum ratings applied to the device are individual stress limit values (not normal operating conditions) and are not valid simultaneously. If these limits are exceeded, device functional operation is not implied, damage may occur and reliability may be affected.

1. Pulse Test: Pulse Width = 5 ms, Duty Cycle $\leq 10\%$.

*For additional information on our Pb–Free strategy and soldering details, please download the ON Semiconductor Soldering and Mounting Techniques Reference Manual, SOLDERRM/D.



ON Semiconductor®

<http://onsemi.com>

15 AMPERE COMPLEMENTARY DARLINGTON POWER TRANSISTORS 250 VOLTS, 175 WATTS

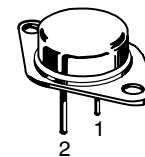
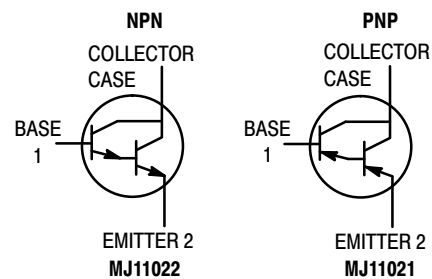

TO–204 (TO–3)
CASE 1–07
STYLE 1

MARKING DIAGRAM

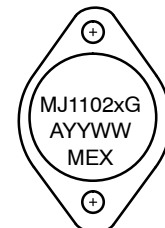

MJ1102x = Device Code
x = 1 or 2
G = Pb–Free Package
A = Location Code
YY = Year
WW = Work Week
MEX = Country of Origin

ORDERING INFORMATION

Device	Package	Shipping
MJ11021	TO–3	100 Units/Tray
MJ11021G	TO–3 (Pb–Free)	100 Units/Tray
MJ11022	TO–3	100 Units/Tray
MJ11022G	TO–3 (Pb–Free)	100 Units/Tray

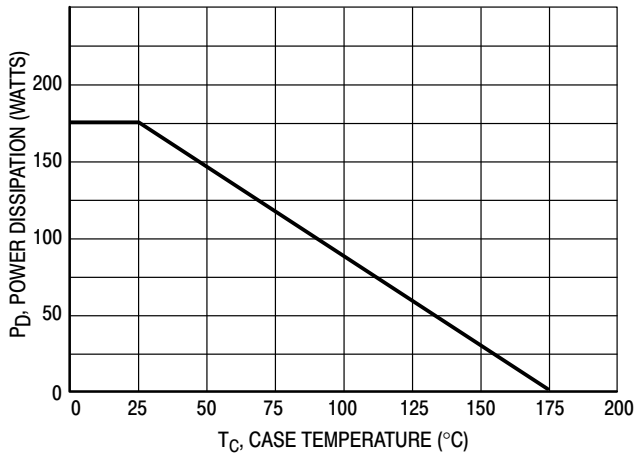
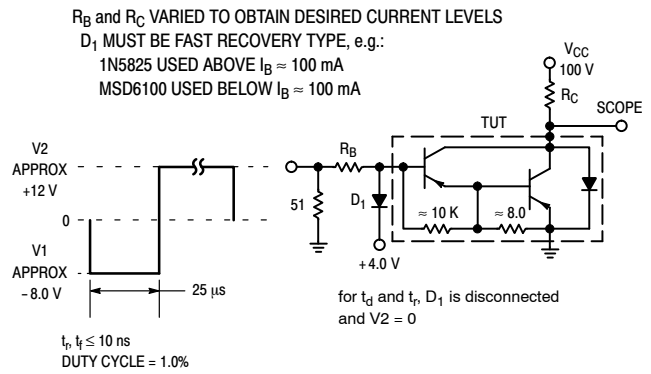

Figure 1. Power Derating



For NPN test circuit reverse diode and voltage polarities.

Figure 2. Switching Times Test Circuit

ELECTRICAL CHARACTERISTICS ($T_C = 25^\circ\text{C}$ unless otherwise noted)

Characteristic	Symbol	Min	Max	Unit
OFF CHARACTERISTICS				
Collector–Emitter Sustaining Voltage (Note 1) ($I_C = 0.1\text{ Adc}$, $I_B = 0$)	$V_{CEO(sus)}$	250	–	Vdc
Collector Cutoff Current ($V_{CE} = 125$, $I_B = 0$)	I_{CEO}	–	1.0	mAdc
Collector Cutoff Current ($V_{CE} = \text{Rated } V_{CB}$, $V_{BE(off)} = 1.5\text{ Vdc}$) ($V_{CE} = \text{Rated } V_{CB}$, $V_{BE(off)} = 1.5\text{ Vdc}$, $T_J = 150^\circ\text{C}$)	I_{CEV}	–	0.5 5.0	mAdc
Emitter Cutoff Current ($V_{BE} = 5.0\text{ Vdc}$, $I_C = 0$)	I_{EBO}	–	2.0	mAdc

ON CHARACTERISTICS (Note 1)

DC Current Gain ($I_C = 10\text{ Adc}$, $V_{CE} = 5.0\text{ Vdc}$) ($I_C = 15\text{ Adc}$, $V_{CE} = 5.0\text{ Vdc}$)	h_{FE}	400 100	15,000 –	–
Collector–Emitter Saturation Voltage ($I_C = 10\text{ Adc}$, $I_B = 100\text{ mA}$) ($I_C = 15\text{ Adc}$, $I_B = 150\text{ mA}$)	$V_{CE(sat)}$	–	2.0 3.4	Vdc
Base–Emitter On Voltage $I_C = 10\text{ A}$, $V_{CE} = 5.0\text{ Vdc}$	$V_{BE(on)}$	–	2.8	Vdc
Base–Emitter Saturation Voltage ($I_C = 15\text{ Adc}$, $I_B = 150\text{ mA}$)	$V_{BE(sat)}$	–	3.8	Vdc

DYNAMIC CHARACTERISTICS

Current–Gain Bandwidth Product ($I_C = 10\text{ Adc}$, $V_{CE} = 3.0\text{ Vdc}$, $f = 1.0\text{ MHz}$)	$[h_{fe}]$	3.0	–	Mhz
Output Capacitance ($V_{CB} = 10\text{ Vdc}$, $I_E = 0$, $f = 0.1\text{ MHz}$)	C_{ob}	–	400 600	pF
Small–Signal Current Gain ($I_C = 10\text{ Adc}$, $V_{CE} = 3.0\text{ Vdc}$, $f = 1.0\text{ kHz}$)	h_{fe}	75	–	–

SWITCHING CHARACTERISTICS

Characteristic	Symbol	Typical		Unit
		NPN	PNP	
Delay Time	t_d	150	75	ns
Rise Time	t_r	1.2	0.5	μs
Storage Time	t_s	4.4	2.7	μs
Fall Time	t_f	10.0	2.5	μs

$(V_{CC} = 100\text{ V}$, $I_C = 10\text{ A}$, $I_B = 100\text{ mA}$, $V_{BE(off)} = 50\text{ V}$) (See Figure 2)

1. Pulsed Test: Pulse Width = 300 μs , Duty Cycle $\leq 2\%$.

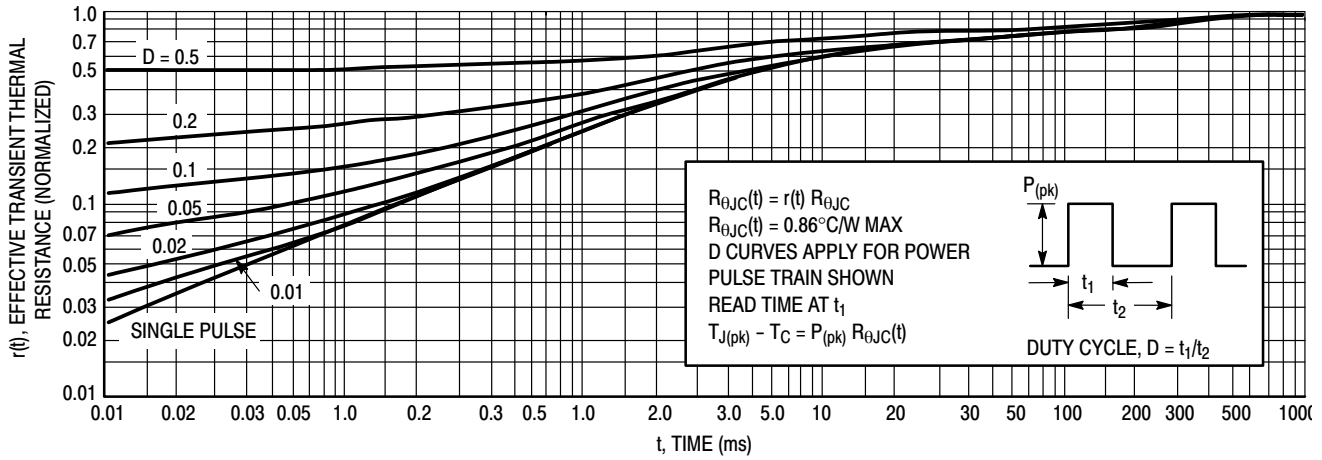

Figure 3. Thermal Response

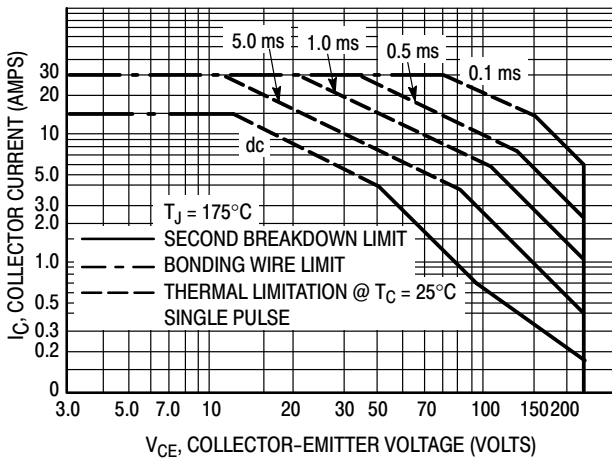

Figure 4. Maximum Rated Forward Bias Safe Operating Area (FBSOA)

FORWARD BIAS

There are two limitations on the power handling ability of a transistor average junction temperature and second breakdown. Safe operating area curves indicate $I_C - V_{CE}$ limits of the transistor that must be observed for reliable operation, i.e., the transistor must not be subjected to greater dissipation than the curves indicate.

The data of Figure 4 is based on $T_{J(pk)} = 175^{\circ}\text{C}$, T_C is variable depending on conditions. Second breakdown pulse limits are valid for duty cycles to 10% provided $T_{J(pk)} \leq 175^{\circ}\text{C}$. $T_{J(pk)}$ may be calculated from the data in Figure 3. At high case temperatures thermal limitations will reduce the power that can be handled to values less than the limitations imposed by second breakdown.

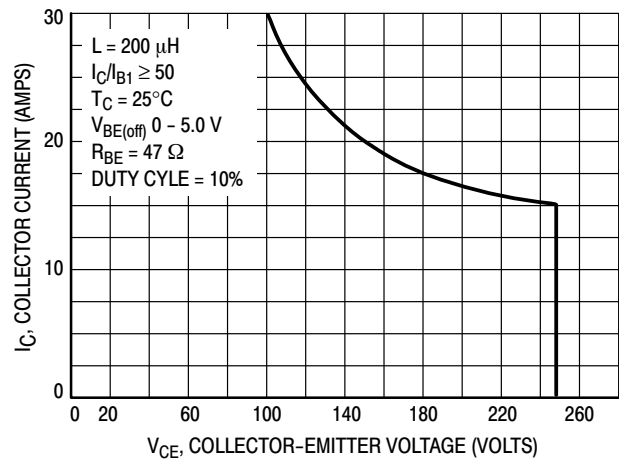

Figure 5. Maximum RBSOA, Reverse Bias Safe Operating Area

REVERSE BIAS

For inductive loads, high voltage and high current must be sustained simultaneously during turn-off, in most cases, with the base to emitter junction reverse biased. Under these conditions the collector voltage must be held to a safe level at or below a specific value of collector current. This can be accomplished by several means such as active clamping, RC snubbing, load line shaping, etc. The safe level for these devices is specified as Reverse Bias Safe Operating Area and represents the voltage-current conditions during reverse biased turn-off. This rating is verified under clamped conditions so that the device is never subjected to an avalanche mode. Figure 5 gives ROSOA characteristics.

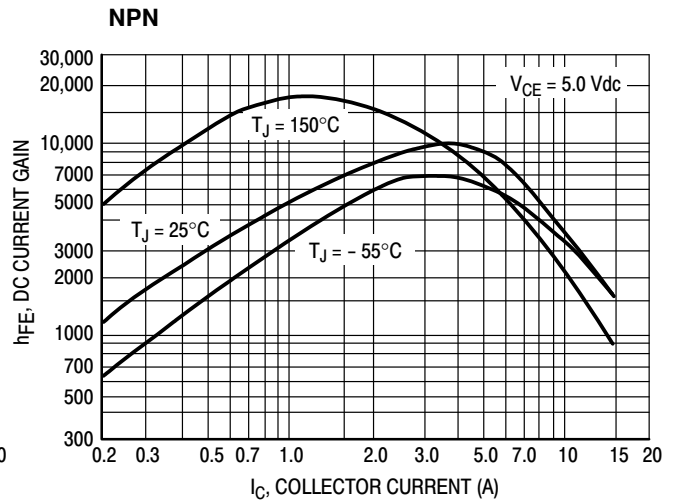
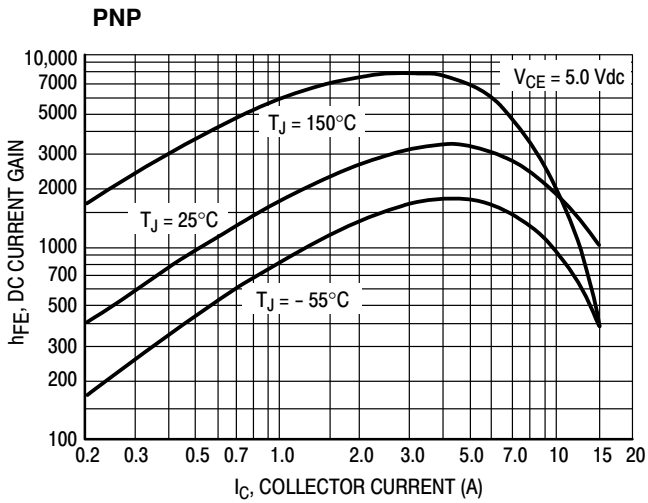

Figure 6. DC Current Gain

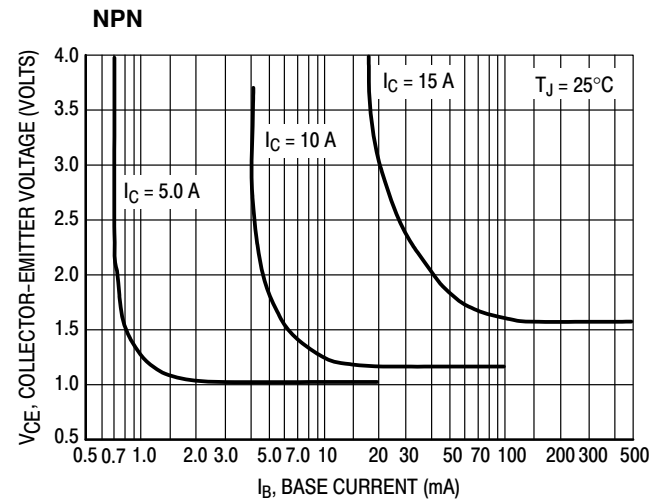
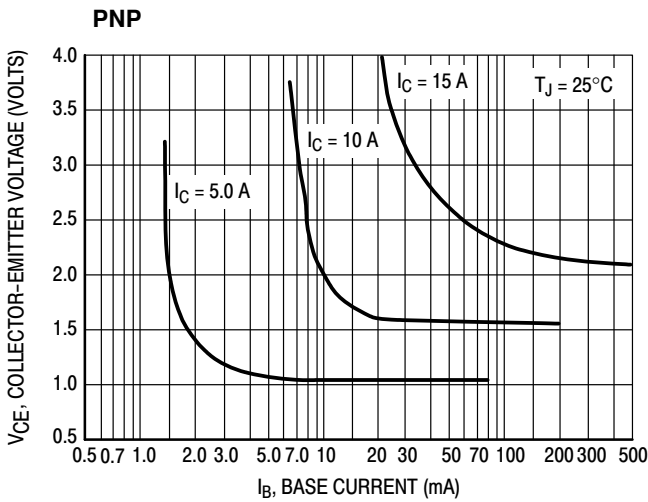

Figure 7. Collector Saturation Region

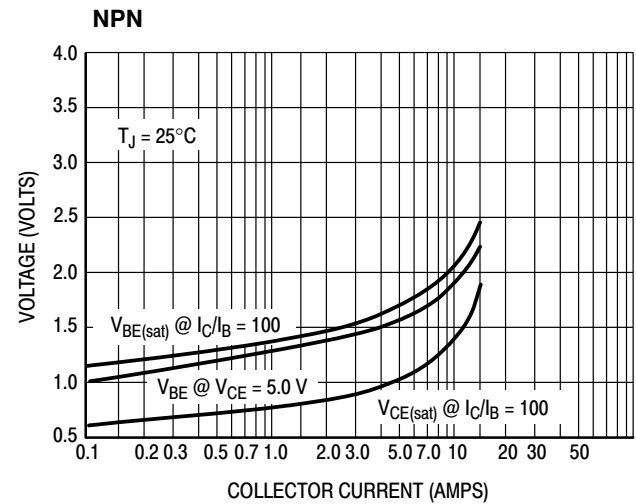
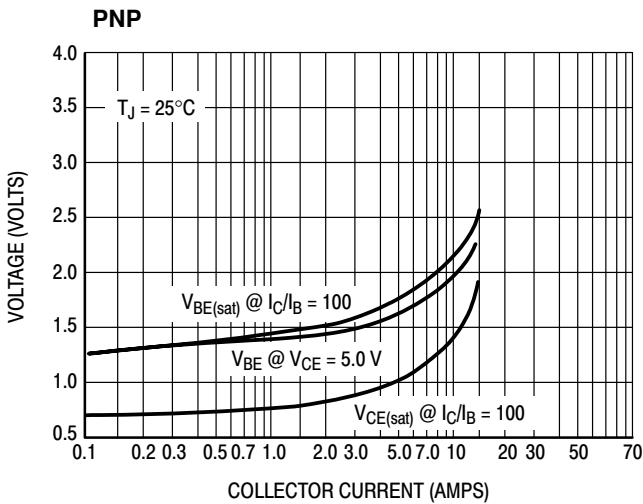

Figure 8. "On" Voltages

MECHANICAL CASE OUTLINE PACKAGE DIMENSIONS



TO-204 (TO-3) CASE 1-07 ISSUE Z

DATE 05/18/1988

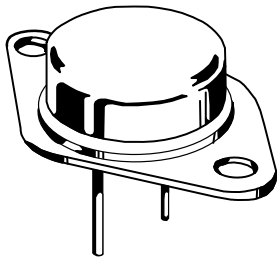

SCALE 1:1

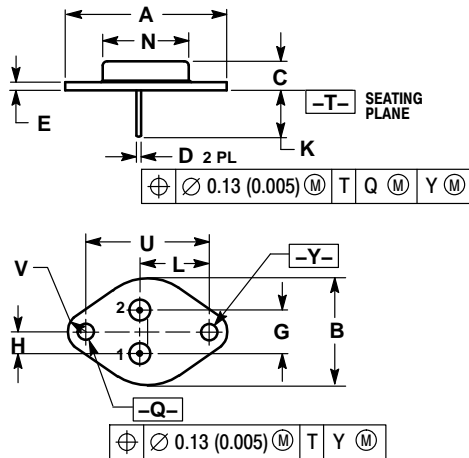

NOTES:

1. DIMENSIONING AND TOLERANCING PER ANSI Y14.5M, 1982.
2. CONTROLLING DIMENSION: INCH.
3. ALL RULES AND NOTES ASSOCIATED WITH REFERENCED TO-204AA OUTLINE SHALL APPLY.

DIM	INCHES		MILLIMETERS	
	MIN	MAX	MIN	MAX
A	1.550 REF		39.37 REF	
B	---	1.050	---	26.67
C	0.250	0.335	6.35	8.51
D	0.038	0.043	0.97	1.09
E	0.055	0.070	1.40	1.77
G	0.430 BSC		10.92 BSC	
H	0.215 BSC		5.46 BSC	
K	0.440	0.480	11.18	12.19
L	0.665 BSC		16.89 BSC	
N	---	0.830	---	21.08
Q	0.151	0.165	3.84	4.19
U	1.187 BSC		30.15 BSC	
V	0.131	0.188	3.33	4.77

- | | | | | |
|--|--|---|---|---|
| <p>STYLE 1:
PIN 1. BASE
2. EMITTER
CASE: COLLECTOR</p> | <p>STYLE 2:
PIN 1. BASE
2. COLLECTOR
CASE: EMITTER</p> | <p>STYLE 3:
PIN 1. GATE
2. SOURCE
CASE: DRAIN</p> | <p>STYLE 4:
PIN 1. GROUND
2. INPUT
CASE: OUTPUT</p> | <p>STYLE 5:
PIN 1. CATHODE
2. EXTERNAL TRIP/DELAY
CASE: ANODE</p> |
| <p>STYLE 6:
PIN 1. GATE
2. EMITTER
CASE: COLLECTOR</p> | <p>STYLE 7:
PIN 1. ANODE
2. OPEN
CASE: CATHODE</p> | <p>STYLE 8:
PIN 1. CATHODE #1
2. CATHODE #2
CASE: ANODE</p> | <p>STYLE 9:
PIN 1. ANODE #1
2. ANODE #2
CASE: CATHODE</p> | |

ON Semiconductor and are trademarks of Semiconductor Components Industries, LLC (SCILLC). SCILLC reserves the right to make changes without further notice to any products herein. SCILLC makes no warranty, representation or guarantee regarding the suitability of its products for any particular purpose, nor does SCILLC assume any liability arising out of the application or use of any product or circuit, and specifically disclaims any and all liability, including without limitation special, consequential or incidental damages. "Typical" parameters which may be provided in SCILLC data sheets and/or specifications can and do vary in different applications and actual performance may vary over time. All operating parameters, including "Typicals" must be validated for each customer application by customer's technical experts. SCILLC does not convey any license under its patent rights nor the rights of others. SCILLC products are not designed, intended, or authorized for use as components in systems intended for surgical implant into the body, or other applications intended to support or sustain life, or for any other application in which the failure of the SCILLC product could create a situation where personal injury or death may occur. Should Buyer purchase or use SCILLC products for any such unintended or unauthorized application, Buyer shall indemnify and hold SCILLC and its officers, employees, subsidiaries, affiliates, and distributors harmless against all claims, costs, damages, and expenses, and reasonable attorney fees arising out of, directly or indirectly, any claim of personal injury or death associated with such unintended or unauthorized use, even if such claim alleges that SCILLC was negligent regarding the design or manufacture of the part. SCILLC is an Equal Opportunity/Affirmative Action Employer.

onsemi, **Onsemi**, and other names, marks, and brands are registered and/or common law trademarks of Semiconductor Components Industries, LLC dba "**onsemi**" or its affiliates and/or subsidiaries in the United States and/or other countries. **onsemi** owns the rights to a number of patents, trademarks, copyrights, trade secrets, and other intellectual property. A listing of **onsemi**'s product/patent coverage may be accessed at www.onsemi.com/site/pdf/Patent-Marking.pdf. **onsemi** reserves the right to make changes at any time to any products or information herein, without notice. The information herein is provided "as-is" and **onsemi** makes no warranty, representation or guarantee regarding the accuracy of the information, product features, availability, functionality, or suitability of its products for any particular purpose, nor does **onsemi** assume any liability arising out of the application or use of any product or circuit, and specifically disclaims any and all liability, including without limitation special, consequential or incidental damages. Buyer is responsible for its products and applications using **onsemi** products, including compliance with all laws, regulations and safety requirements or standards, regardless of any support or applications information provided by **onsemi**. "Typical" parameters which may be provided in **onsemi** data sheets and/or specifications can and do vary in different applications and actual performance may vary over time. All operating parameters, including "Typicals" must be validated for each customer application by customer's technical experts. **onsemi** does not convey any license under any of its intellectual property rights nor the rights of others. **onsemi** products are not designed, intended, or authorized for use as a critical component in life support systems or any FDA Class 3 medical devices or medical devices with a same or similar classification in a foreign jurisdiction or any devices intended for implantation in the human body. Should Buyer purchase or use **onsemi** products for any such unintended or unauthorized application, Buyer shall indemnify and hold **onsemi** and its officers, employees, subsidiaries, affiliates, and distributors harmless against all claims, costs, damages, and expenses, and reasonable attorney fees arising out of, directly or indirectly, any claim of personal injury or death associated with such unintended or unauthorized use, even if such claim alleges that **onsemi** was negligent regarding the design or manufacture of the part. **onsemi** is an Equal Opportunity/Affirmative Action Employer. This literature is subject to all applicable copyright laws and is not for resale in any manner.

PUBLICATION ORDERING INFORMATION

LITERATURE FULFILLMENT:

Email Requests to: orderlit@onsemi.com

onsemi Website: www.onsemi.com

TECHNICAL SUPPORT

North American Technical Support:

Voice Mail: 1 800-282-9855 Toll Free USA/Canada

Phone: 011 421 33 790 2910

Europe, Middle East and Africa Technical Support:

Phone: 00421 33 790 2910

For additional information, please contact your local Sales Representative

X-ON Electronics

Largest Supplier of Electrical and Electronic Components

Click to view similar products for [Darlington Transistors](#) category:

Click to view products by [ON Semiconductor](#) manufacturer:

Other Similar products are found below :

[NJVMJD128T4G](#) [281287X](#) [BDV64B](#) [NJVMJD117T4G](#) [LB1205-L-E](#) [2N6053](#) [MPSA14](#) [TIP140](#) [MPSA13](#) [TIP127L-BP](#) [2N6383](#)
[ULN2003ACM/TR](#) [2N7371](#) [2N6058](#) [2N6059](#) [2N6051](#) [MJ2501](#) [MJ3001](#) [2SB1560](#) [2SB852KT146B](#) [2SD2560](#) [TIP112TU](#) [BCV27](#)
[MMBTA13-TP](#) [MMSTA28T146](#) [NTE2557](#) [NJVNJD35N04T4G](#) [MPSA29-D26Z](#) [FJB102TM](#) [BSP61H6327XTSA1](#) [BU941ZPFI](#)
[2SD1980TL](#) [NTE2350](#) [NTE245](#) [NTE246](#) [NTE2649](#) [NTE46](#) [NTE98](#) [ULN2003ADR2G](#) [NTE2344](#) [NTE2349](#) [NTE2405](#) [NTE243](#) [NTE244](#)
[NTE247](#) [NTE248](#) [NTE249](#) [NTE253](#) [NTE2548](#) [NTE261](#)