



Is Now Part of



**ON Semiconductor®**

To learn more about ON Semiconductor, please visit our website at  
[www.onsemi.com](http://www.onsemi.com)

Please note: As part of the Fairchild Semiconductor integration, some of the Fairchild orderable part numbers will need to change in order to meet ON Semiconductor's system requirements. Since the ON Semiconductor product management systems do not have the ability to manage part nomenclature that utilizes an underscore (\_), the underscore (\_) in the Fairchild part numbers will be changed to a dash (-). This document may contain device numbers with an underscore (\_). Please check the ON Semiconductor website to verify the updated device numbers. The most current and up-to-date ordering information can be found at [www.onsemi.com](http://www.onsemi.com). Please email any questions regarding the system integration to [Fairchild\\_questions@onsemi.com](mailto:Fairchild_questions@onsemi.com).

ON Semiconductor and the ON Semiconductor logo are trademarks of Semiconductor Components Industries, LLC dba ON Semiconductor or its subsidiaries in the United States and/or other countries. ON Semiconductor owns the rights to a number of patents, trademarks, copyrights, trade secrets, and other intellectual property. A listing of ON Semiconductor's product/patent coverage may be accessed at [www.onsemi.com/site/pdf/Patent-Marking.pdf](http://www.onsemi.com/site/pdf/Patent-Marking.pdf). ON Semiconductor reserves the right to make changes without further notice to any products herein. ON Semiconductor makes no warranty, representation or guarantee regarding the suitability of its products for any particular purpose, nor does ON Semiconductor assume any liability arising out of the application or use of any product or circuit, and specifically disclaims any and all liability, including without limitation special, consequential or incidental damages. Buyer is responsible for its products and applications using ON Semiconductor products, including compliance with all laws, regulations and safety requirements or standards, regardless of any support or applications information provided by ON Semiconductor. "Typical" parameters which may be provided in ON Semiconductor data sheets and/or specifications can and do vary in different applications and actual performance may vary over time. All operating parameters, including "Typicals" must be validated for each customer application by customer's technical experts. ON Semiconductor does not convey any license under its patent rights nor the rights of others. ON Semiconductor products are not designed, intended, or authorized for use as a critical component in life support systems or any FDA Class 3 medical devices or medical devices with a same or similar classification in a foreign jurisdiction or any devices intended for implantation in the human body. Should Buyer purchase or use ON Semiconductor products for any such unintended or unauthorized application, Buyer shall indemnify and hold ON Semiconductor and its officers, employees, subsidiaries, affiliates, and distributors harmless against all claims, costs, damages, and expenses, and reasonable attorney fees arising out of, directly or indirectly, any claim of personal injury or death associated with such unintended or unauthorized use, even if such claim alleges that ON Semiconductor was negligent regarding the design or manufacture of the part. ON Semiconductor is an Equal Opportunity/Affirmative Action Employer. This literature is subject to all applicable copyright laws and is not for resale in any manner.



April 2016

# MMBF5434 N-Channel Switch

## Features

- This device is designed for digital switching applications where very low on resistance is mandatory.
- Sourced from Process 58.

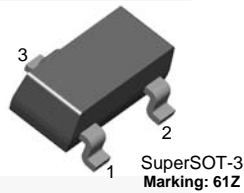

1. Drain 2. Source 3. Gate

## Ordering Information

Part Number	Top Mark	Package	Packing Method
MMBF5434	61Z	SSOT 3L	Tape and Reel

## Absolute Maximum Ratings<sup>(1), (2)</sup>

Stresses exceeding the absolute maximum ratings may damage the device. The device may not function or be operable above the recommended operating conditions and stressing the parts to these levels is not recommended. In addition, extended exposure to stresses above the recommended operating conditions may affect device reliability. The absolute maximum ratings are stress ratings only. Values are at  $T_A = 25^\circ\text{C}$  unless otherwise noted.

Symbol	Parameter	Value	Unit
$V_{DG}$	Drain-Gate Voltage	25	V
$V_{GS}$	Gate-Source Voltage	-25	V
$I_{GF}$	Forward Gate Current	10	mA
$T_J, T_{STG}$	Operating and Storage Junction Temperature Range	-55 to 150	$^\circ\text{C}$

### Notes:

1. These ratings are based on a maximum junction temperature of  $150^\circ\text{C}$ .
2. These are steady-state limits. Fairchild Semiconductor should be consulted on applications involving pulsed or low-duty-cycle operations.

## Thermal Characteristics

Values are at  $T_A = 25^\circ\text{C}$  unless otherwise noted.

Symbol	Parameter	Max.	Unit
$P_D$	Total Device Dissipation	350	mW
	Derate Above $25^\circ\text{C}$	2.8	mW/ $^\circ\text{C}$
$R_{\theta JA}$	Thermal Resistance, Junction-to-Ambient <sup>(3)</sup>	556	$^\circ\text{C}/\text{W}$

### Notes:

3. PCB size: FR-4, 76 mm x 114 mm x 1.57 mm (3.0 inch x 4.5 inch x 0.062 inch) with minimum land pattern size.

## Electrical Characteristics

Values are at  $T_A = 25^\circ\text{C}$  unless otherwise noted.

Symbol	Parameter	Conditions	Min.	Max.	Unit
<b>Off Characteristics</b>					
$V_{(BR)GSS}$	Gate-Source Breakdown Voltage	$I_G = -1 \mu\text{A}$ , $V_{DS} = 0$	-25		V
$I_{GSS}$	Gate Reverse Current	$V_{GS} = -15 \text{ V}$ , $V_{DS} = 0$		200	nA
$V_{GS(off)}$	Gate-Source Cut-Off Voltage	$V_{DS} = 5 \text{ V}$ , $I_D = 3\text{nA}$	-1.0	-4.0	V
$I_{D(off)}$	Gate-Source Cutoff Voltage	$V_{DS} = 5.0$ , $V_{GS} = -10 \text{ V}$		200	pA
<b>On Characteristics</b>					
$I_{DSS}$	Zero-Gate Voltage Drain Current <sup>(4)</sup>	$V_{DS} = 15 \text{ V}$ , $I_{GS} = 0$	30		mA
$r_{DS(on)}$	Drain-Source On Resistance	$V_{GS} = 0$ , $I_D = 10 \text{ mA}$		10	$\Omega$
<b>Small Signal Characteristics</b>					
$C_{iss}$	Input Capacitance	$V_{DS} = 0$ , $V_{GS} = 10 \text{ V}$ , $f = 1.0 \text{ MHz}$		30	pF
$C_{rss}$	Reverse Transfer Capacitance	$V_{DS} = 0$ , $V_{GS} = 10 \text{ V}$ , $f = 1.0 \text{ MHz}$		15	pF

### Note:

4. Pulse test: pulse width  $\leq 300 \mu\text{s}$ , duty cycle  $\leq 2\%$ .

## Typical Performance Characteristics

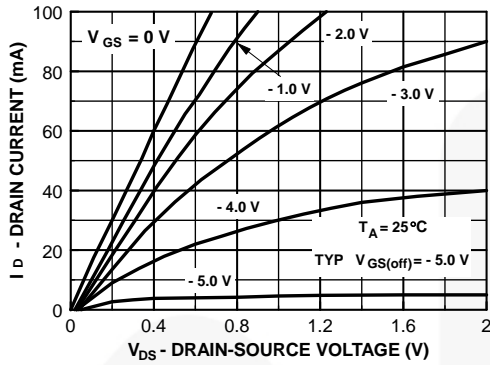

Figure 1. Common Drain-Source

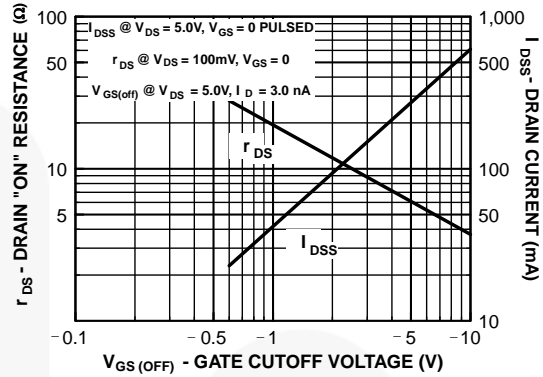

Figure 2. Parameter Interactions

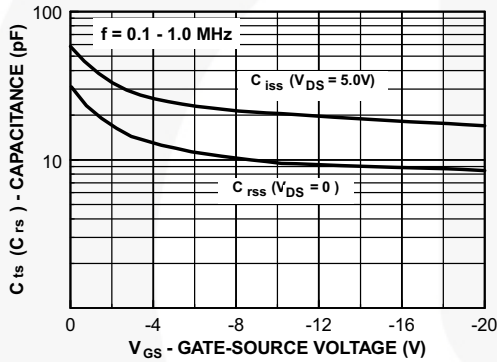

Figure 3. Common Drain-Source

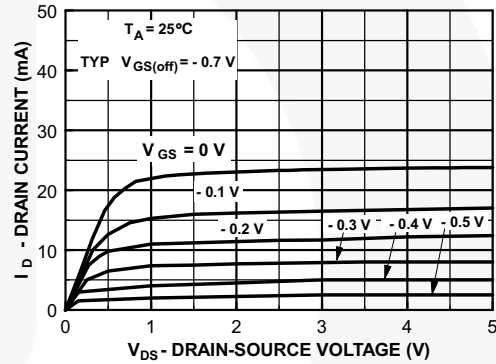

Figure 4. Common Drain-Source

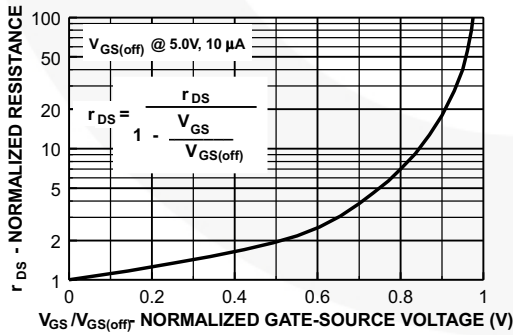

Figure 5. Normalized Drain Resistance vs. Bias Voltage

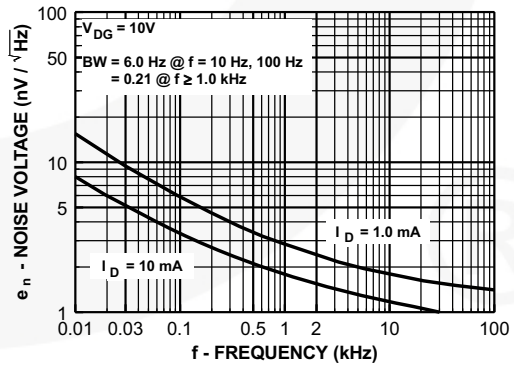

Figure 6. Noise Voltage vs. Frequency

Typical Performance Characteristics (Continued)

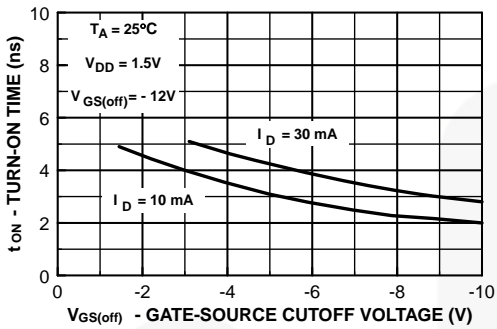

Figure 7. Switching Turn-On Time vs. Gate-Source Cut-Off Voltage

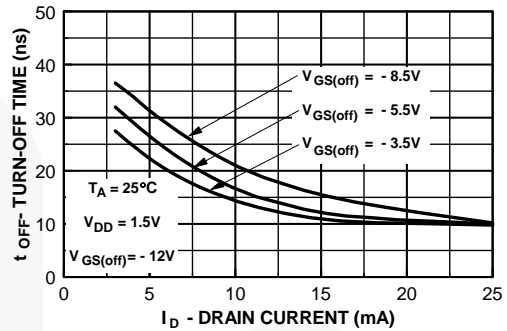

Figure 8. Switching Turn-Off Time vs. Drain Current

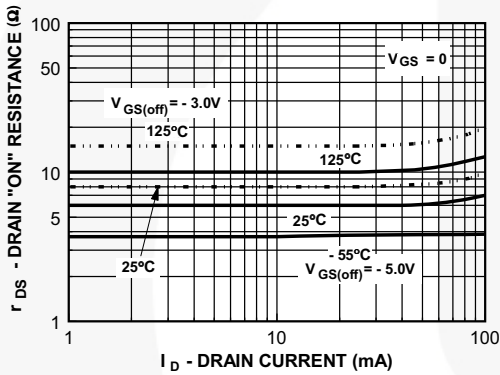

Figure 9. On Resistance vs. Drain Current

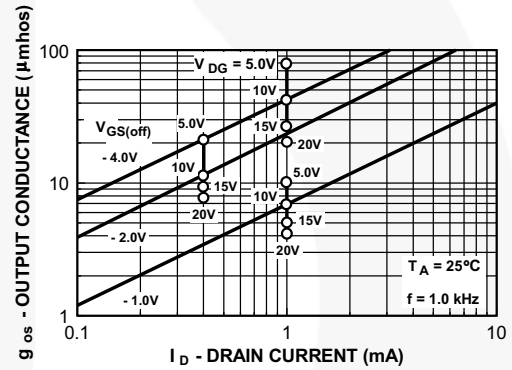

Figure 10. Output Conductance vs. Drain Current

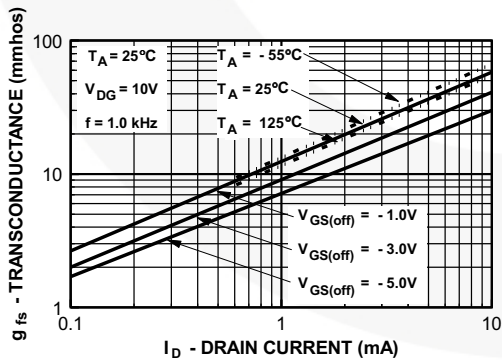

Figure 11. Transconductance vs. Drain Current

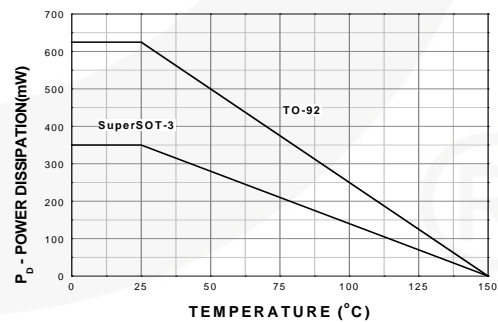
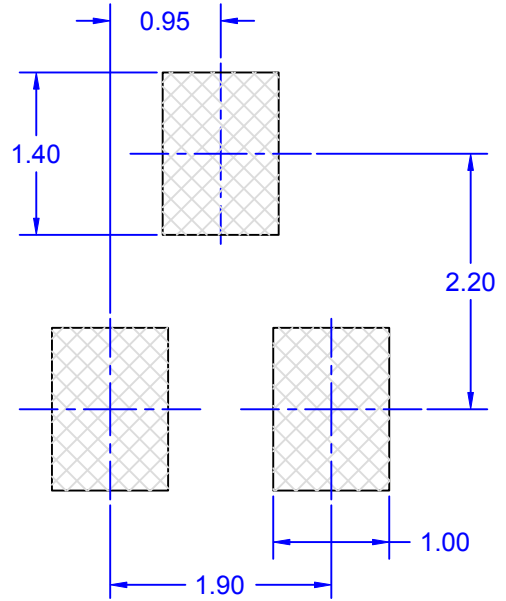
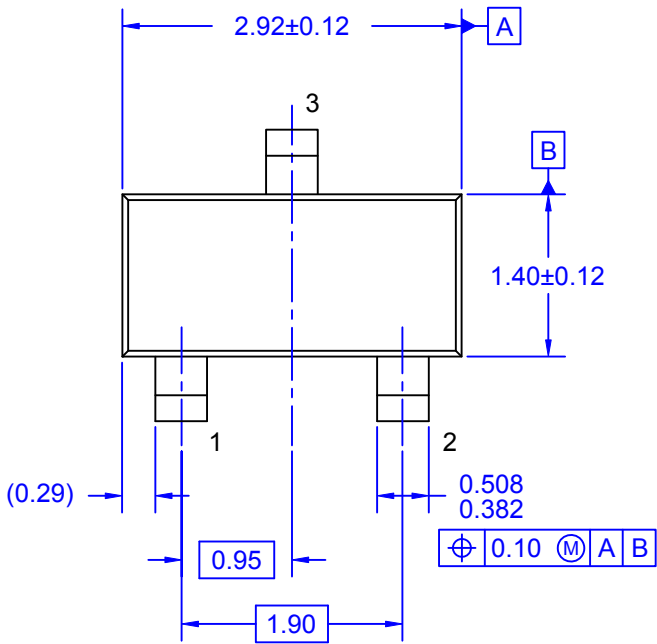
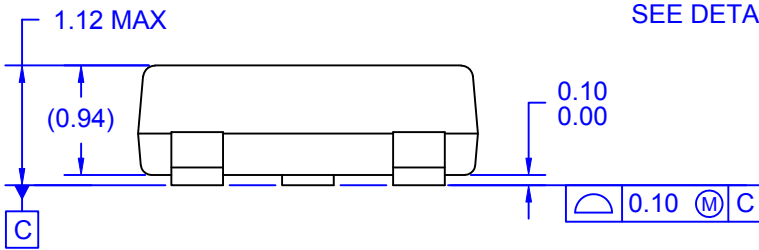

Figure 12. Power Dissipation vs. Ambient Temperature



LAND PATTERN RECOMMENDATION



SEE DETAIL A

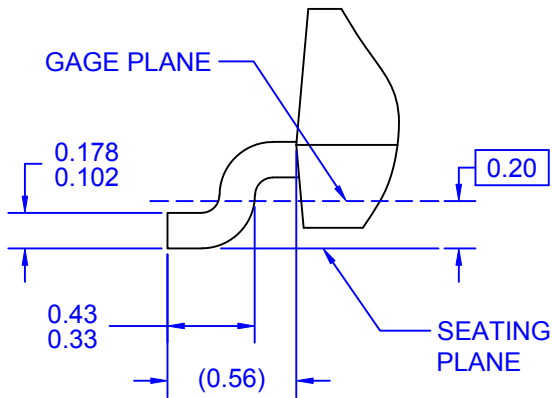
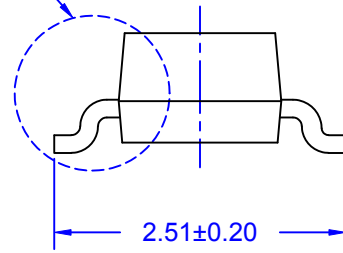

**DETAIL A**

SCALE: 50:1

NOTES: UNLESS OTHERWISE SPECIFIED

- A) NO JEDEC REFERENCE AS OF AUGUST 2003
- B) ALL DIMENSIONS ARE IN MILLIMETERS.
- C) DIMENSIONS ARE EXCLUSIVE OF BURRS, MOLD FLASH AND TIE BAR EXTRUSIONS.
- D) DIMENSIONING AND TOLERANCING PER ASME Y14.5M - 2009.
- E) DRAWING FILE NAME: MKT-MA03BREV3



ON Semiconductor and  are trademarks of Semiconductor Components Industries, LLC dba ON Semiconductor or its subsidiaries in the United States and/or other countries. ON Semiconductor owns the rights to a number of patents, trademarks, copyrights, trade secrets, and other intellectual property. A listing of ON Semiconductor's product/patent coverage may be accessed at [www.onsemi.com/site/pdf/Patent-Marking.pdf](http://www.onsemi.com/site/pdf/Patent-Marking.pdf). ON Semiconductor reserves the right to make changes without further notice to any products herein. ON Semiconductor makes no warranty, representation or guarantee regarding the suitability of its products for any particular purpose, nor does ON Semiconductor assume any liability arising out of the application or use of any product or circuit, and specifically disclaims any and all liability, including without limitation special, consequential or incidental damages. Buyer is responsible for its products and applications using ON Semiconductor products, including compliance with all laws, regulations and safety requirements or standards, regardless of any support or applications information provided by ON Semiconductor. "Typical" parameters which may be provided in ON Semiconductor data sheets and/or specifications can and do vary in different applications and actual performance may vary over time. All operating parameters, including "Typicals" must be validated for each customer application by customer's technical experts. ON Semiconductor does not convey any license under its patent rights nor the rights of others. ON Semiconductor products are not designed, intended, or authorized for use as a critical component in life support systems or any FDA Class 3 medical devices or medical devices with a same or similar classification in a foreign jurisdiction or any devices intended for implantation in the human body. Should Buyer purchase or use ON Semiconductor products for any such unintended or unauthorized application, Buyer shall indemnify and hold ON Semiconductor and its officers, employees, subsidiaries, affiliates, and distributors harmless against all claims, costs, damages, and expenses, and reasonable attorney fees arising out of, directly or indirectly, any claim of personal injury or death associated with such unintended or unauthorized use, even if such claim alleges that ON Semiconductor was negligent regarding the design or manufacture of the part. ON Semiconductor is an Equal Opportunity/Affirmative Action Employer. This literature is subject to all applicable copyright laws and is not for resale in any manner.

## PUBLICATION ORDERING INFORMATION

### LITERATURE FULFILLMENT:

Literature Distribution Center for ON Semiconductor  
19521 E. 32nd Pkwy, Aurora, Colorado 80011 USA  
**Phone:** 303-675-2175 or 800-344-3860 Toll Free USA/Canada  
**Fax:** 303-675-2176 or 800-344-3867 Toll Free USA/Canada  
**Email:** [orderlit@onsemi.com](mailto:orderlit@onsemi.com)

**N. American Technical Support:** 800-282-9855 Toll Free  
USA/Canada  
**Europe, Middle East and Africa Technical Support:**  
Phone: 421 33 790 2910  
**Japan Customer Focus Center**  
Phone: 81-3-5817-1050

**ON Semiconductor Website:** [www.onsemi.com](http://www.onsemi.com)  
**Order Literature:** <http://www.onsemi.com/orderlit>  
For additional information, please contact your local  
Sales Representative

## X-ON Electronics

Largest Supplier of Electrical and Electronic Components

*Click to view similar products for JFET category:*

*Click to view products by [ON Semiconductor](#) manufacturer:*

Other Similar products are found below :

[MCH3914-8-TL-H](#) [F5606](#) [2SK2394-6-TB-E](#) [CPH5901G-TL-E](#) [MCH3914-7-TL-H](#) [MCH5908H-TL-E](#) [CPH5902G-TL-E](#) [CPH5905G-TL-E](#)  
[CPH5905H-TL-E](#) [2SK2394-7-TB-E](#) [NSVJ2394SA3T1G](#) [2N3819](#) [PN4393](#) [MMBF5103](#) [MMBFJ202](#) [2N4393](#) [U311](#) [2N5397](#) [2SK208-](#)  
[GR\(TE85L,F\)](#) [J176\\_D74Z](#) [2N2608](#) [2N2609](#) [2N3821](#) [2N3823](#) [2N3954](#) [2N3970](#) [2N3971](#) [2N3972](#) [2N4091](#) [2N4092](#) [2N4093](#) [2N4118](#)  
[2N4118A](#) [2N4220](#) [2N4221A](#) [2N4338](#) [2N4339](#) [2N4341](#) [2N4416](#) [2N4416A](#) [2N4856](#) [2N4858](#) [2N4861](#) [2N4861A](#) [2N5020](#) [2N5115](#) [2N6550](#)  
[IF1331](#) [IF140](#) [IFN146](#)