

# TinyLogic ULP-A Exclusive-OR Gate

## NC7SP86

The NC7SP86 is a single 2-input exclusive-OR gate in tiny footprint packages. The device is designed to operate for  $V_{CC} = 0.9\text{ V}$  to  $3.6\text{ V}$ .

### Features

- Designed for 0.9 V to 3.6 V  $V_{CC}$  Operation
- 2.2 ns  $t_{PD}$  at 3.3 V (Typ)
- Inputs/Outputs Over-Voltage Tolerant up to 3.6 V
- $I_{OFF}$  Supports Partial Power Down Protection
- Source/Sink 2.6 mA at 3.3 V
- Available in SC-88A and MicroPak™ Packages
- These Devices are Pb-Free, Halogen Free/BFR Free and are RoHS Compliant

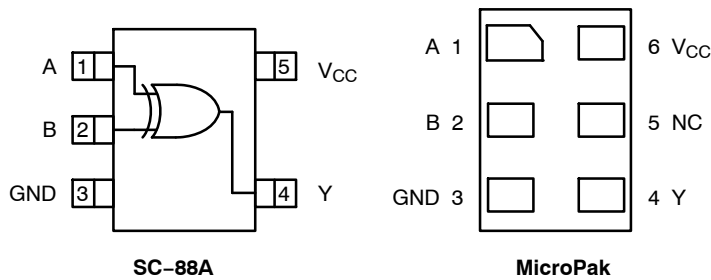

Figure 1. Pinout Diagrams (Top Views)

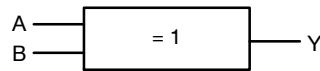
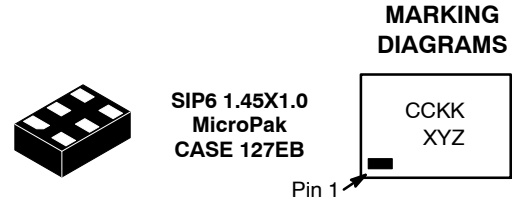

Figure 2. Logic Symbol

### PIN ASSIGNMENT

Pin	SC88A	MicroPak
1	A	A
2	B	B
3	GND	GND
4	Y	Y
5	$V_{CC}$	N.C.
6	-	$V_{CC}$

N.C. = No Connect



SIP6 1.45X1.0  
MicroPak  
CASE 127EB

- CC = Specific Device Code
- KK = 2-Digit Lot Run Traceability Code
- XY = 2-Digit Date Code
- Z = Assembly Plant Code



SC-88A  
CASE 419A-02

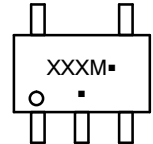

- XXX = Specific Device Code
- M = Date Code
- = Pb-Free Package

### ORDERING INFORMATION

See detailed ordering, marking and shipping information on page 6 of this data sheet.

### FUNCTION TABLE

Input		Output
A	B	Y
L	L	L
L	H	H
H	L	H
H	H	L

# NC7SP86

## MAXIMUM RATINGS

Symbol	Characteristics	Value	Unit
V <sub>CC</sub>	DC Supply Voltage	-0.5 to +4.3	V
V <sub>IN</sub>	DC Input Voltage	-0.5 to +4.3	V
V <sub>OUT</sub>	DC Output Voltage Active-Mode (High or Low State) Tri-State Mode (Note 1) Power-Down Mode (V <sub>CC</sub> = 0 V)	-0.5 to V <sub>CC</sub> + 0.5 -0.5 to +4.3 -0.5 to +4.3	V
I <sub>IK</sub>	DC Input Diode Current V <sub>IN</sub> < GND	-50	mA
I <sub>OK</sub>	DC Output Diode Current V <sub>OUT</sub> < GND	-50	mA
I <sub>OUT</sub>	DC Output Source/Sink Current	±50	mA
I <sub>CC</sub> or I <sub>GND</sub>	DC Supply Current per Supply Pin or Ground Pin	±50	mA
T <sub>STG</sub>	Storage Temperature Range	-65 to +150	°C
T <sub>L</sub>	Lead Temperature, 1 mm from Case for 10 Seconds	260	°C
T <sub>J</sub>	Junction Temperature Under Bias	+150	°C
θ <sub>JA</sub>	Thermal Resistance (Note 2)	SC-88A MicroPak 377 154	°C/W
P <sub>D</sub>	Power Dissipation in Still Air	SC-88A MicroPak 332 812	mW
MSL	Moisture Sensitivity	Level 1	-
F <sub>R</sub>	Flammability Rating Oxygen Index: 28 to 34	UL 94 V-0 @ 0.125 in	-
V <sub>ESD</sub>	ESD Withstand Voltage (Note 3) Human Body Model Charged Device Model	2000 1000	V
I <sub>Latchup</sub>	Latchup Performance (Note 4)	±100	mA

Stresses exceeding those listed in the Maximum Ratings table may damage the device. If any of these limits are exceeded, device functionality should not be assumed, damage may occur and reliability may be affected.

1. Applicable to devices with outputs that may be tri-stated.
2. Measured with minimum pad spacing on an FR4 board, using 10 mm-by-1 inch, 2 ounce copper trace no air flow per JESD51-7.
3. HBM tested to EIA / JESD22-A114-A. CDM tested to JESD22-C101-A. JEDEC recommends that ESD qualification to EIA/JESD22-A115A (Machine Model) be discontinued.
4. Tested to EIA/JESD78 Class II.

## RECOMMENDED OPERATING CONDITIONS

Symbol	Parameter	Min	Max	Unit
V <sub>CC</sub>	Positive DC Supply Voltage	0.9	3.6	V
V <sub>IN</sub>	DC Input Voltage	0	3.6	V
V <sub>OUT</sub>	DC Output Voltage Active-Mode (High or Low State) Tri-State Mode (Note 1) Power-Down Mode (V <sub>CC</sub> = 0 V)	0 0 0	V <sub>CC</sub> 3.6 3.6	V
T <sub>A</sub>	Operating Temperature Range	-40	+85	°C
t <sub>r</sub> , t <sub>f</sub>	Input Transition Rise and Fall Time V <sub>CC</sub> = 3.3 V ± 0.3 V	0	10	ns/V

Functional operation above the stresses listed in the Recommended Operating Ranges is not implied. Extended exposure to stresses beyond the Recommended Operating Ranges limits may affect device reliability.

# NC7SP86

## DC ELECTRICAL CHARACTERISTICS

Symbol	Parameter	Condition	V <sub>CC</sub> (V)	T <sub>A</sub> = 25°C			T <sub>A</sub> = -40°C to +85°C		Unit
				Min	Typ	Max	Min	Max	
V <sub>IH</sub>	High-Level Input Voltage		0.9	-	0.5	-	-	-	V
			1.1 to 1.3	0.65 x V <sub>CC</sub>	-	-	0.65 x V <sub>CC</sub>	-	
			1.4 to 1.6	0.65 x V <sub>CC</sub>	-	-	0.65 x V <sub>CC</sub>	-	
			1.65 to 1.95	0.65 x V <sub>CC</sub>	-	-	0.65 x V <sub>CC</sub>	-	
			2.3 to 2.7	1.6	-	-	1.6	-	
			3.0 to 3.6	2.1	-	-	2.1	-	
V <sub>IL</sub>	Low-Level Input Voltage		0.9	-	0.5	-	-	-	V
			1.1 to 1.3	-	-	0.35 x V <sub>CC</sub>	-	0.35 x V <sub>CC</sub>	
			1.4 to 1.6	-	-	0.35 x V <sub>CC</sub>	-	0.35 x V <sub>CC</sub>	
			1.65 to 1.95	-	-	0.35 x V <sub>CC</sub>	-	0.35 x V <sub>CC</sub>	
			2.3 to 2.7	-	-	0.7	-	0.7	
			3.0 to 3.6	-	-	0.9	-	0.9	
V <sub>OH</sub>	High-Level Output Voltage	V <sub>IN</sub> = V <sub>IH</sub> or V <sub>IL</sub>							V
		I <sub>OH</sub> = -20 μA	0.9	-	V <sub>CC</sub> - 0.1	-	-	-	
			1.1 to 1.3	V <sub>CC</sub> - 0.1	-	-	V <sub>CC</sub> - 0.1	-	
			1.4 to 1.6	V <sub>CC</sub> - 0.1	-	-	V <sub>CC</sub> - 0.1	-	
			1.65 to 1.95	V <sub>CC</sub> - 0.1	-	-	V <sub>CC</sub> - 0.1	-	
			2.3 to 2.7	V <sub>CC</sub> - 0.1	-	-	V <sub>CC</sub> - 0.1	-	
			3.0 to 3.6	V <sub>CC</sub> - 0.1	-	-	V <sub>CC</sub> - 0.1	-	
		I <sub>OH</sub> = -0.5 mA	1.1 to 1.3	0.75 x V <sub>CC</sub>	-	-	0.70 x V <sub>CC</sub>	-	
		I <sub>OH</sub> = -1 mA	1.4 to 1.6	1.07	-	-	0.99	-	
		I <sub>OH</sub> = -1.5 mA	1.65 to 1.95	1.24	-	-	1.22	-	
I <sub>OH</sub> = -2.1 mA	2.3 to 2.7	1.95	-	-	1.87	-			
I <sub>OH</sub> = -2.6 mA	3.0 to 3.6	2.61	-	-	2.55	-			
V <sub>OL</sub>	Low-Level Output Voltage	V <sub>IN</sub> = V <sub>IH</sub> or V <sub>IL</sub>							V
		I <sub>OL</sub> = 20 μA	0.9	-	0.1	-	-	-	
			1.1 to 1.3	-	-	0.1	-	0.1	
			1.4 to 1.6	-	-	0.1	-	0.1	
			1.65 to 1.95	-	-	0.1	-	0.1	
			2.3 to 2.7	-	-	0.1	-	0.1	
			3.0 to 3.6	-	-	0.1	-	0.1	
		I <sub>OL</sub> = 0.5 mA	1.1 to 1.3	-	-	0.3 x V <sub>CC</sub>	-	0.3 x V <sub>CC</sub>	
		I <sub>OL</sub> = 1 mA	1.4 to 1.6	-	-	0.31	-	0.37	
		I <sub>OL</sub> = 1.5 mA	1.65 to 1.95	-	-	0.31	-	0.35	
I <sub>OL</sub> = 2.1 mA	2.3 to 2.7	-	-	0.31	-	0.33			
I <sub>OL</sub> = 2.6 mA	3.0 to 3.6	-	-	0.31	-	0.33			
I <sub>IN</sub>	Input Leakage Current	V <sub>IN</sub> = 0 V to 3.6 V	0.9 to 3.6	-	-	±0.1	-	±0.5	μA
I <sub>OFF</sub>	Power Off Leakage Current	V <sub>IN</sub> = 0 V to 3.6 V or V <sub>OUT</sub> = 0 V to 3.6 V	0	-	-	0.5	-	0.5	μA
I <sub>CC</sub>	Quiescent Supply Current	V <sub>IN</sub> = V <sub>CC</sub> or GND	0.9 to 3.6	-	-	0.9	-	0.9	μA

Product parametric performance is indicated in the Electrical Characteristics for the listed test conditions, unless otherwise noted. Product performance may not be indicated by the Electrical Characteristics if operated under different conditions.

# NC7SP86

## AC ELECTRICAL CHARACTERISTICS

Symbol	Parameter	Condition	V <sub>CC</sub> (V)	T <sub>A</sub> = 25°C			T <sub>A</sub> = -40°C to +85°C		Unit
				Min	Typ	Max	Min	Max	
t <sub>PLH</sub> , t <sub>PHL</sub>	Propagation Delay, (A or B) to Y (Figures 3 and 4)	R <sub>L</sub> = 1 MΩ, C <sub>L</sub> = 10 pF	0.9	-	44.8	-	-	-	ns
			1.10 to 1.30	-	12.3	24.7	-	32.9	
			1.40 to 1.60	-	6.3	13.9	-	15.6	
			1.65 to 1.95	-	4.3	11.1	-	13.6	
			2.3 to 2.7	-	2.9	8.0	-	9.0	
			3.0 to 3.6	-	2.2	6.7	-	7.9	
t <sub>PLH</sub> , t <sub>PHL</sub>	Propagation Delay, (A or B) to Y (Figures 3 and 4)	R <sub>L</sub> = 1 MΩ, C <sub>L</sub> = 15 pF	0.9	-	46.3	-	-	-	ns
			1.10 to 1.30	-	12.8	26.0	-	35.9	
			1.40 to 1.60	-	6.7	14.8	-	17.5	
			1.65 to 1.95	-	4.7	11.8	-	14.1	
			2.3 to 2.7	-	3.2	8.4	-	9.2	
			3.0 to 3.6	-	2.4	7.1	-	8.0	
t <sub>PLH</sub> , t <sub>PHL</sub>	Propagation Delay, (A or B) to Y (Figures 3 and 4)	R <sub>L</sub> = 1 MΩ, C <sub>L</sub> = 30 pF	0.9	-	50.6	-	-	-	ns
			1.10 to 1.30	-	14.4	30.0	-	45.0	
			1.40 to 1.60	-	8.0	17.5	-	19.5	
			1.65 to 1.95	-	5.8	13.5	-	15.5	
			2.3 to 2.7	-	3.9	10.0	-	11.0	
			3.0 to 3.6	-	3.0	8.0	-	9.9	

## CAPACITIVE CHARACTERISTICS

Symbol	Parameter	Test Condition	Typical (T <sub>A</sub> = 25°C)	Unit
C <sub>IN</sub>	Input Capacitance	V <sub>CC</sub> = 0 V	2.0	pF
C <sub>OUT</sub>	Output Capacitance	V <sub>CC</sub> = 0 V	4.0	pF
C <sub>PD</sub>	Power Dissipation Capacitance (Note 5)	f = 10 MHz, V <sub>CC</sub> = 0.9 to 3.6 V, V <sub>IN</sub> = 0 V or V <sub>CC</sub>	6.0	pF

5. C<sub>PD</sub> is defined as the value of the internal equivalent capacitance which is calculated from the operating current consumption without load. Average operating current can be obtained by the equation I<sub>CC(OPR)</sub> = C<sub>PD</sub> • V<sub>CC</sub> • f<sub>in</sub> + I<sub>CC</sub>. C<sub>PD</sub> is used to determine the no-load dynamic power consumption: P<sub>D</sub> = C<sub>PD</sub> • V<sub>CC</sub><sup>2</sup> • f<sub>in</sub> + I<sub>CC</sub> • V<sub>CC</sub>.

# NC7SP86

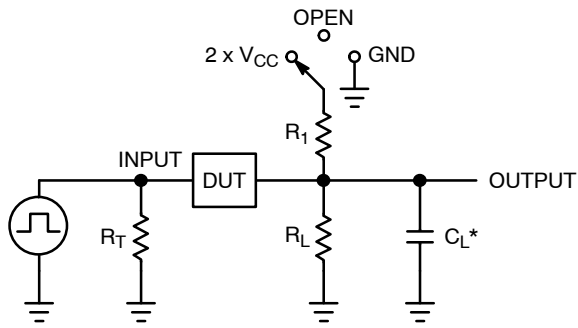

$C_L$  includes probe and jig capacitance  
 $R_T$  is  $Z_{OUT}$  of pulse generator (typically 50  $\Omega$ )  
 $f = 1$  MHz

Test	Switch Position
$t_{PLH} / t_{PHL}$	Open
$t_{PLZ} / t_{PZL}$	$2 \times V_{CC}$
$t_{PHZ} / t_{PZH}$	GND

Figure 3. Test Circuit



$V_{CC}, V$	$V_{mi}, V$	$V_{mo}, V$	$V_Y, V$
0.9	$V_{CC} / 2$	$V_{CC} / 2$	0.1
1.1 to 1.3	$V_{CC} / 2$	$V_{CC} / 2$	0.1
1.4 to 1.6	$V_{CC} / 2$	$V_{CC} / 2$	0.1
1.65 to 1.95	$V_{CC} / 2$	$V_{CC} / 2$	0.15
2.3 to 2.7	$V_{CC} / 2$	$V_{CC} / 2$	0.15
3.0 to 3.6	1.5	1.5	0.3

Figure 4. Switching Waveforms

# NC7SP86

## ORDERING INFORMATION

Device	Package	Marking	Pin 1 Orientation (See below)	Shipping <sup>†</sup>
NC7SP86P5X	SC-88A	P86	Q4	3000 / Tape & Reel
NC7SP86L6X	MicroPak	L4	Q4	5000 / Tape & Reel

<sup>†</sup>For information on tape and reel specifications, including part orientation and tape sizes, please refer to our Tape and Reel Packaging Specifications Brochure, BRD8011/D.

### Pin 1 Orientation in Tape and Reel

Direction of Feed

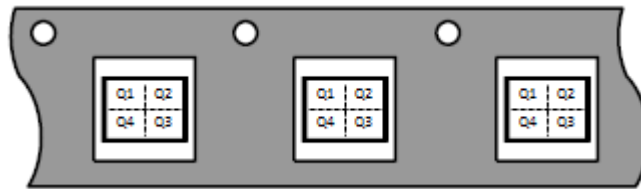

MicroPak is a trademark of Semiconductor Components Industries, LLC dba "onsemi" or its affiliates and/or subsidiaries in the United States and/or other countries.

# NC7SP86

## PACKAGE DIMENSIONS

SIP6 1.45X1.0  
CASE 127EB  
ISSUE O

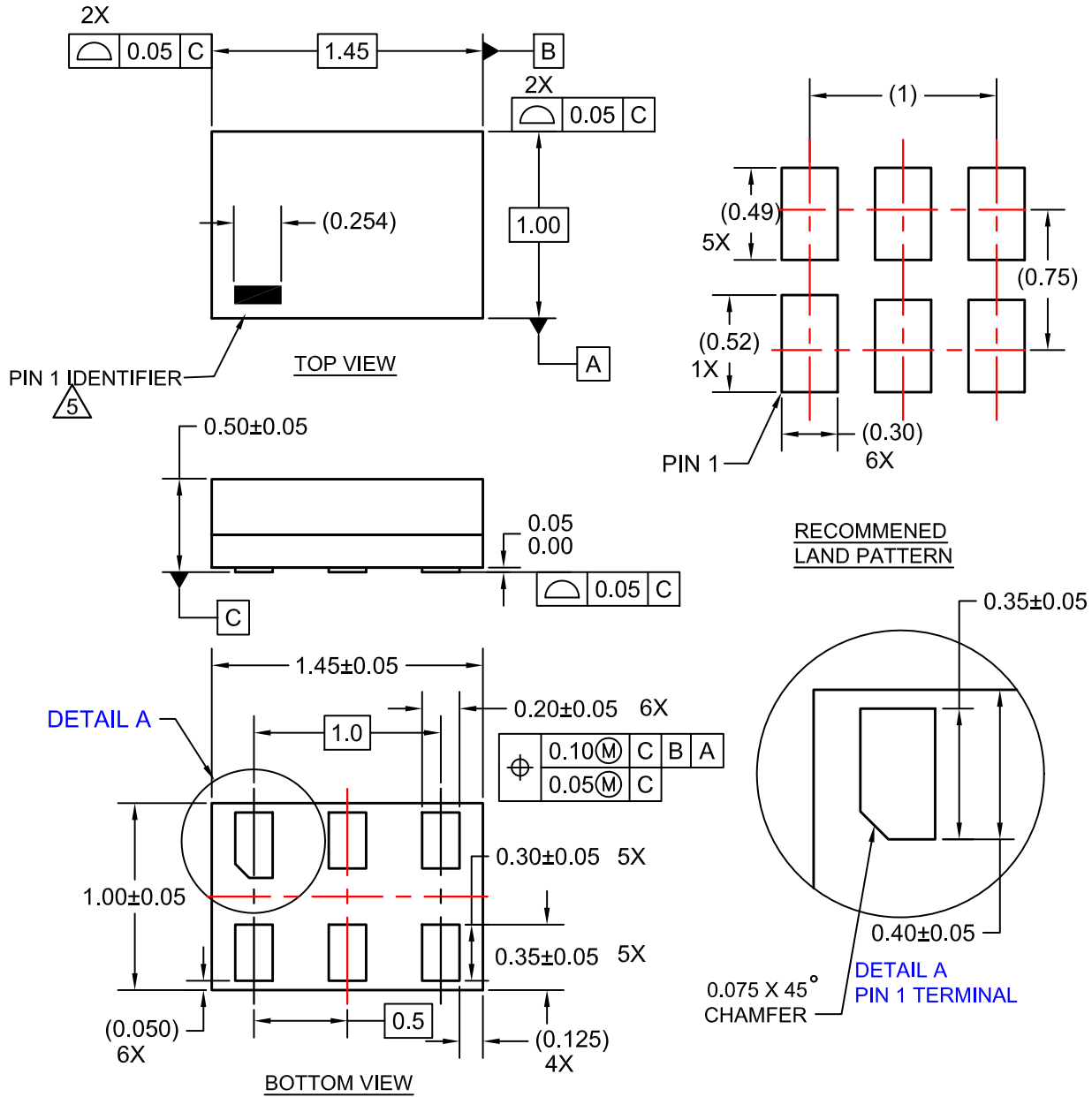

**NOTES:**

1. CONFORMS TO JEDEC STANDARD MO-252 VARIATION UAAD
2. DIMENSIONS ARE IN MILLIMETERS
3. DRAWING CONFORMS TO ASME Y14.5M-2009
4. PIN ONE IDENTIFIER IS 2X LENGTH OF ANY OTHER LINE IN THE MARK CODE LAYOUT.

# NC7SP86

## PACKAGE DIMENSIONS

SC-88A (SC-70-5/SOT-353)  
CASE 419A-02  
ISSUE L

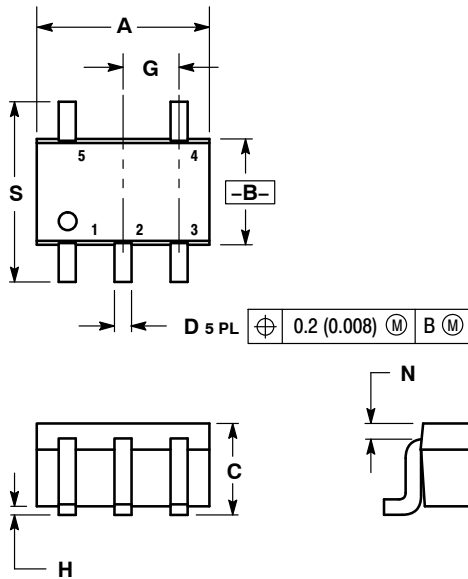

### NOTES:

1. DIMENSIONING AND TOLERANCING PER ANSI Y14.5M, 1982.
2. CONTROLLING DIMENSION: INCH.
3. 419A-01 OBSOLETE. NEW STANDARD 419A-02.
4. DIMENSIONS A AND B DO NOT INCLUDE MOLD FLASH, PROTRUSIONS, OR GATE BURRS.

DIM	INCHES		MILLIMETERS	
	MIN	MAX	MIN	MAX
A	0.071	0.087	1.80	2.20
B	0.045	0.053	1.15	1.35
C	0.031	0.043	0.80	1.10
D	0.004	0.012	0.10	0.30
G	0.026 BSC		0.65 BSC	
H	---	0.004	---	0.10
J	0.004	0.010	0.10	0.25
K	0.004	0.012	0.10	0.30
N	0.008 REF		0.20 REF	
S	0.079	0.087	2.00	2.20

### SOLDER FOOTPRINT

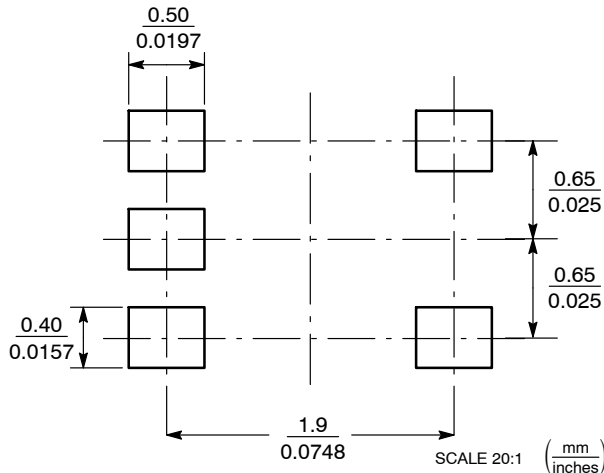

**onsemi, Onsemi**, and other names, marks, and brands are registered and/or common law trademarks of Semiconductor Components Industries, LLC dba "onsemi" or its affiliates and/or subsidiaries in the United States and/or other countries. onsemi owns the rights to a number of patents, trademarks, copyrights, trade secrets, and other intellectual property. A listing of onsemi's product/patent coverage may be accessed at [www.onsemi.com/site/pdf/Patent-Marketing.pdf](http://www.onsemi.com/site/pdf/Patent-Marketing.pdf). onsemi reserves the right to make changes at any time to any products or information herein, without notice. The information herein is provided "as-is" and onsemi makes no warranty, representation or guarantee regarding the accuracy of the information, product features, availability, functionality, or suitability of its products for any particular purpose, nor does onsemi assume any liability arising out of the application or use of any product or circuit, and specifically disclaims any and all liability, including without limitation special, consequential or incidental damages. Buyer is responsible for its products and applications using onsemi products, including compliance with all laws, regulations and safety requirements or standards, regardless of any support or applications information provided by onsemi. "Typical" parameters which may be provided in onsemi data sheets and/or specifications can and do vary in different applications and actual performance may vary over time. All operating parameters, including "Typicals" must be validated for each customer application by customer's technical experts. onsemi does not convey any license under any of its intellectual property rights nor the rights of others. onsemi products are not designed, intended, or authorized for use as a critical component in life support systems or any FDA Class 3 medical devices or medical devices with a same or similar classification in a foreign jurisdiction or any devices intended for implantation in the human body. Should Buyer purchase or use onsemi products for any such unintended or unauthorized application, Buyer shall indemnify and hold onsemi and its officers, employees, subsidiaries, affiliates, and distributors harmless against all claims, costs, damages, and expenses, and reasonable attorney fees arising out of, directly or indirectly, any claim of personal injury or death associated with such unintended or unauthorized use, even if such claim alleges that onsemi was negligent regarding the design or manufacture of the part. onsemi is an Equal Opportunity/Affirmative Action Employer. This literature is subject to all applicable copyright laws and is not for resale in any manner.

### PUBLICATION ORDERING INFORMATION

LITERATURE FULFILLMENT:  
Email Requests to: [orderlit@onsemi.com](mailto:orderlit@onsemi.com)

onsemi Website: [www.onsemi.com](http://www.onsemi.com)

TECHNICAL SUPPORT  
North American Technical Support:  
Voice Mail: 1 800-282-9855 Toll Free USA/Canada  
Phone: 011 421 33 790 2910

Europe, Middle East and Africa Technical Support:  
Phone: 00421 33 790 2910  
For additional information, please contact your local Sales Representative



## X-ON Electronics

Largest Supplier of Electrical and Electronic Components

*Click to view similar products for [Logic Gates](#) category:*

*Click to view products by [ON Semiconductor](#) manufacturer:*

Other Similar products are found below :

[74HC85N](#) [NLU1G32AMUTCG](#) [NLV7SZ58DFT2G](#) [CD4068BE](#) [NL17SG32P5T5G](#) [NL17SG86DFT2G](#) [NLV14001UBDR2G](#)

[NLX1G11AMUTCG](#) [NLX1G97MUTCG](#) [74LS38](#) [74LVC32ADTR2G](#) [MC74HCT20ADTR2G](#) [NLV17SZ00DFT2G](#) [NLV17SZ02DFT2G](#)

[NLV74HC02ADR2G](#) [74HC32S14-13](#) [74LS133](#) [74LVC1G32Z-7](#) [M38510/30402BDA](#) [74LVC1G86Z-7](#) [74LVC2G08RA3-7](#)

[NLV74HC08ADTR2G](#) [NLV74HC14ADR2G](#) [NLV74HC20ADR2G](#) [NLX2G86MUTCG](#) [5962-8973601DA](#) [74LVC2G02HD4-7](#)

[NLU1G00AMUTCG](#) [74LVC2G32RA3-7](#) [74LVC2G00HD4-7](#) [NL17SG02P5T5G](#) [74LVC2G00HK3-7](#) [74LVC2G86HK3-7](#)

[NLX1G99DMUTWG](#) [NLVVHC1G00DFT2G](#) [NLVHC1G08DFT2G](#) [NLV7SZ57DFT2G](#) [NLV74VHC04DTR2G](#) [NLV27WZ86USG](#)

[NLV27WZ00USG](#) [NLU1G86CMUTCG](#) [NLU1G08CMUTCG](#) [NL17SZ32P5T5G](#) [NL17SZ00P5T5G](#) [NL17SH02P5T5G](#) [74AUP2G00RA3-7](#)

[NLV74HC02ADTR2G](#) [NLX1G332CMUTCG](#) [NL17SG86P5T5G](#) [NL17SZ05P5T5G](#)