

NCP1521BEVB

NCP1521B Adjustable Output Voltage Step-Down Converter Evaluation Board User's Manual



ON Semiconductor®

<http://onsemi.com>

EVAL BOARD USER'S MANUAL

Overview

The NCP1521B step-down PWM DC-DC converter is optimized for portable applications powered from one cell Li-ion or three cell Alkaline/NiCd/NiMH batteries.

The part is available in adjustable output voltage versions ranging from 0.9 V to 3.3 V. It uses synchronous rectification to increase efficiency and reduce external part count. The device also has a built-in 1.5 MHz (nominal) oscillator

which reduces component size by allowing smaller inductors and capacitors. Automatic switching PWM/PFM mode offers improved system efficiency.

Additional features include integrated soft-start, cycle-by-cycle current limiting and thermal shutdown protection. The NCP1521B is available in space saving, low profile TSOP5 and UDFN6 packages.

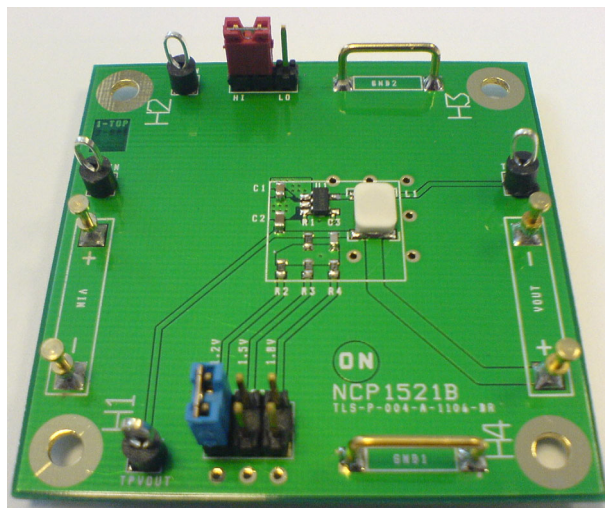

Figure 1. Board Picture in TSOP-5

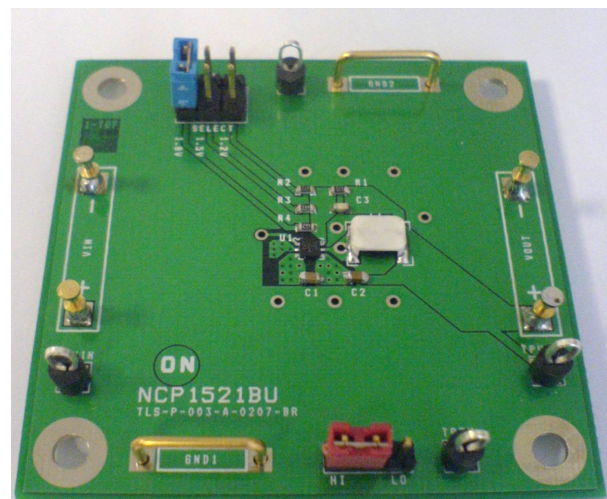

Figure 2. Board Picture in μ DFN-6

NCP1521BEVB

MAXIMUM RATINGS

Maximum ratings are those values beyond which damage to the device may occur. Exposure to these conditions or conditions beyond those indicated may adversely affect device reliability. Functional operation under absolute maximum-rated conditions is not implied. Functional operation should be restricted to the Recommended Operating Conditions (Note 1).

Rating	Symbol	Value	Unit
Minimum Voltage All Pins	V_{min}	-0.3	V
Maximum Voltage All Pins (Note 2)	V_{max}	7.0	V
Maximum Voltage EN1, EN2, FB, LX	V_{max}	$V_{IN} + 0.3$	V
Thermal Resistance Junction-to-Air	$R_{\theta ja}$	300 260	°C/W
		TSOP-5 UDFN-6	
Operating Ambient Temperature Range	T_A	-40 to 85	°C
Storage Temperature Range	T_{stg}	-55 to 150	°C
Junction Operating Temperature	T_J	-40 to 125	°C
Latch-up current maximum rating $T_a=85^\circ\text{C}$ (Note 4) other pins	I_u	± 100	mA
ESD Withstand Voltage (Note 3)	V_{esd}	2.0 200	kV V
		Human Body Model Machine Model	
Moisture Sensitivity Level (Note 5)	MSL	1	per IPC

Stresses exceeding Maximum Ratings may damage the device. Maximum Ratings are stress ratings only. Functional operation above the Recommended Operating Conditions is not implied. Extended exposure to stresses above the Recommended Operating Conditions may affect device reliability.

1. Maximum electrical ratings are defined as those values beyond which damage to the device may occur at $T_A = 25^\circ\text{C}$
2. According JEDEC standard JESD22-A108B
3. This device series contains ESD protection and exceeds the following tests:
Human Body Model (HBM) per JEDEC standard: JESD22-A114
Machine Model (MM) per JEDEC standard: JESD22-A115
4. Latchup current maximum rating per JEDEC standard: JESD78.
5. JEDEC Standard: J-STD-020A.

ELECTRICAL CHARACTERISTICS

For Electrical Characteristic, please see our NCP1521B datasheet available at <http://www.onsemi.com/PowerSolutions/product.do?id=NCP1521B>

NCP1521B – BOARD CONNECTIONS

Symbol	Switch Descriptions
--------	---------------------

INPUT POWER

V_{IN+}	This is the positive connection for power supply.
V_{IN-}	This is the return connection for the power supply
GND1, GND2	Ground clip

SETUP

ENABLE	To enable the buck converter, connect a shorting jumper between ENABLE-1 and ENABLE-2. To disable the buck converter, connect a shorting jumper between ENABLE-3 and ENABLE-2.
SELECT	A shorting jumper must be used to select an output voltage of 1.2 V, 1.5 V or 1.8 V

OUTPUT POWER

V_{OUT+}	This is the positive connection of the output voltage.
V_{OUT-}	This is the return connection of the output voltage.

TEST POINT

T_{PVIN}	This is the test point of the input voltage.
T_{PEN}	This is the test point of the enable pin.
T_{PLX}	This is the test point of the inductor voltage.
T_{PVOUT}	This is the test point of the output voltage.

NCP1521BEVB

NCP1521B – BOARD SCHEMATIC

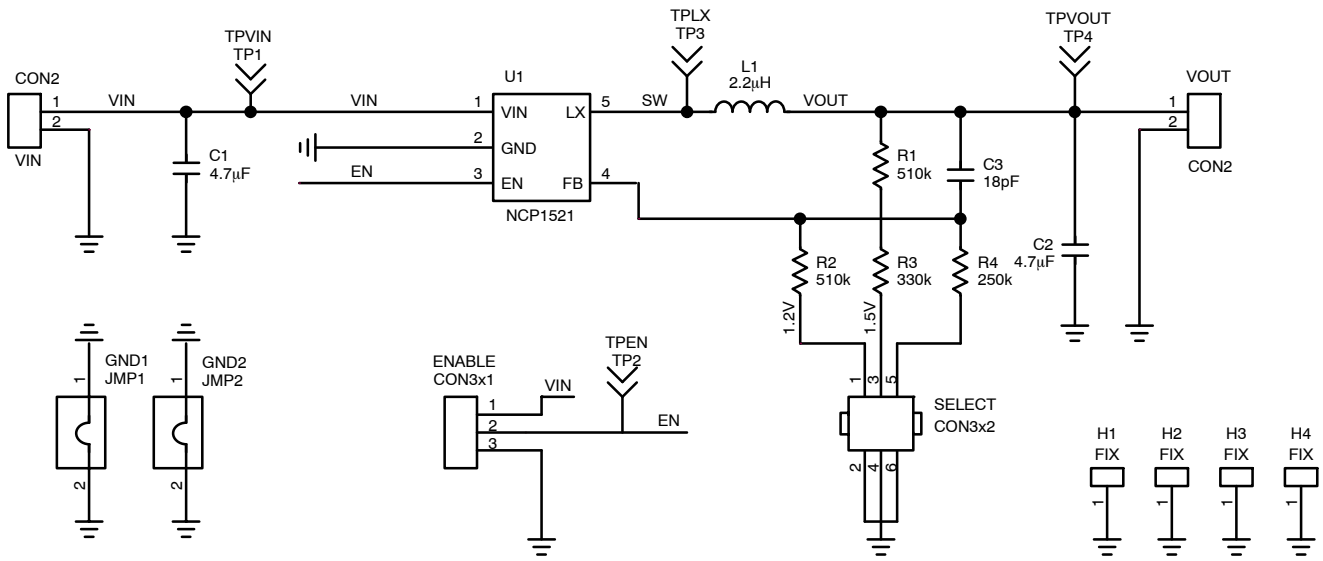

Figure 3. Board Schematic in TSOP-5

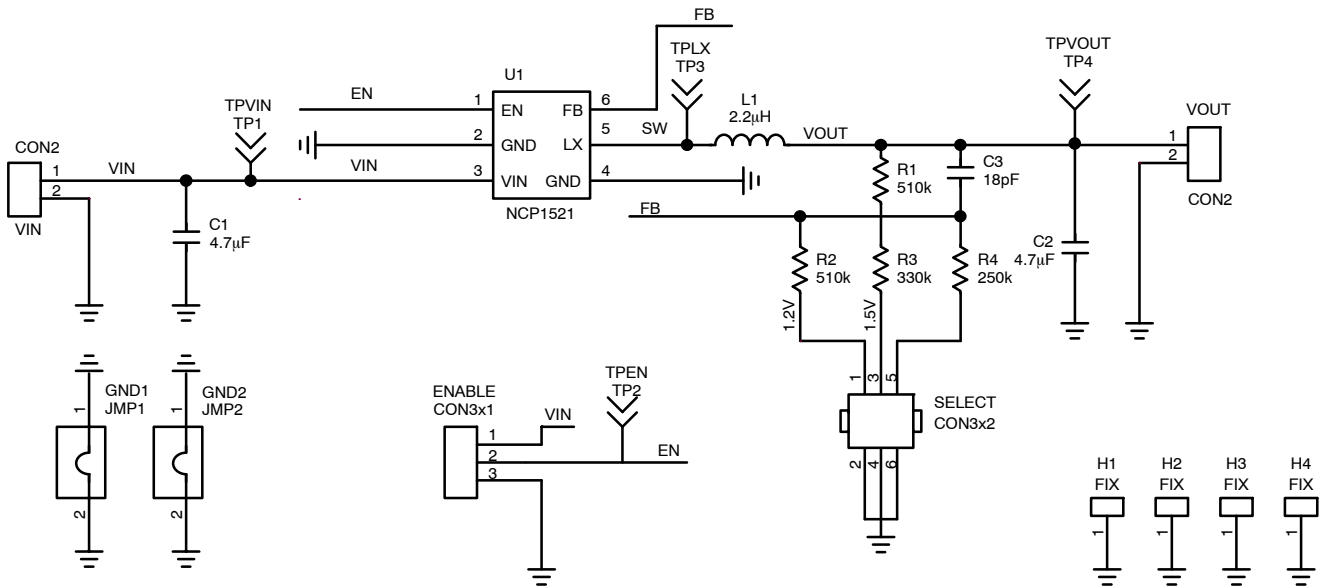

Figure 4. Board Schematic in µDFN-6

NCP1521BEVB

NCP1521B – TEST PROCEDURE

Equipment needed

- 10 pt. Times (*list:bull2*)
- Power supply
- Digital Volt Meter
- Digital Amp Meter

Test

1. Jumper ENABLE should be open.
2. Jumper SELECT should be closed to 1.2 V.
3. Set the power supply to 3.6 V and the current limit of at least 800 mA.
4. Connect the power supply connector to connectors V_{IN+} and V_{IN-} . The DC current measurement on V_{IN} line should be around 0.3 μ A.
5. Close ENABLE connector. The DC current measurement on V_{IN} line should be around 40 μ A.
6. Measure the output voltage between V_{OUT+} and V_{OUT-} connectors. You should see around 1.2 V voltage operation.
7. Remove the ENABLE jumper. The DC current measurement on V_{IN} line should be back around 0.3 μ A.

NCP1521B – BILL OF MATERIAL

Designator	Qty	Description	Value	Tolerance	Foot-print	Manufacturer	Manufacturer Part Number
U1	1	IC, Converter, DC/DC	NA	NA	TSOP5 UDFN	ON Semiconductor	NCP1521B NCP1521BU
C1	1	Ceramic capacitor	4.7 μ F, 10 V, X5R	10%	0805	TDK	C1608X5R1A475
C2	1	Ceramic capacitor	10 μ F, 6.3 V, X5R	10%	0603	TDK	C1608X5R0J105
C3	1	Ceramic capacitor	18 pF, 50 V, COG	5%	0603	TDK	C1608C0G1H180
R1, R2	2	SMD resistor	510k	1%	0603	std	std
R3	1	SMD resistor	330k	1%	0603	std	std
R4	1	SMD resistor	240k	1%	0603	std	std
L1	1	Inductor	2.2 μ H	30%	1210	Coilcraft	LPS3008-222NL
VIN, VOUT	4	Connector	NA	NA	NA	Kontek Comatel Cambion	3110014000500 160-1724-02-05-00
ENABLE	1	3 Pin Jumper Header	NA	NA	2.54mm	TYCO/AMP Molex / Waldom	5-826629-0 90120-0160
SELECT	1	3x2 Pin Jumper Header	NA	NA	2.54mm	TYCO/AMP Molex / Waldom	4731955180470 90131-0140
GND1, GND2	2	Jumper for GND	NA	NA	10.16mm	Harwin Molex / Waldom	D3082-01 90120-0160
TPEN, TPLX, TPVIN, TPVOUT	4	Test point type 3	NA	NA	ϕ 1.60mm	Keystone	5010
PCB	1	50.8mm x 50.8mm x 1.0 mm 4 Layers	NA	NA	NA	Any	TLS-P-004-A-1106-BR TLS-P-003-A-0207-BR

NCP1521BEVB

NCP1521B – PCB LAYOUT

Board Reference: TLS-P-004-A-1106-BR

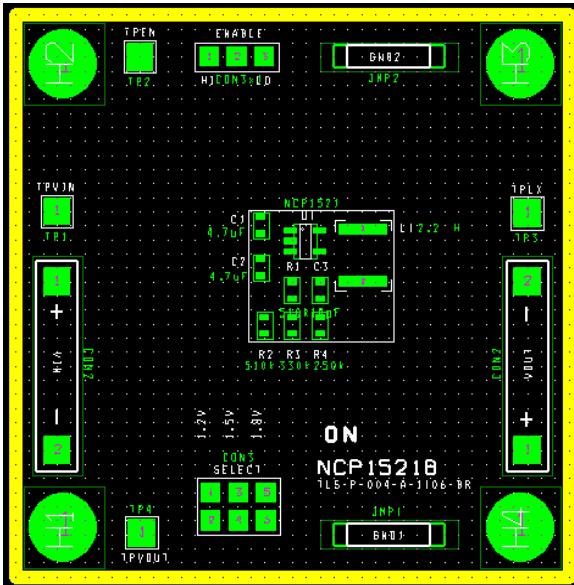

Figure 5. Assembly Layer in TSOP-5

Board Reference: TLS-P-003-A-0207-BR

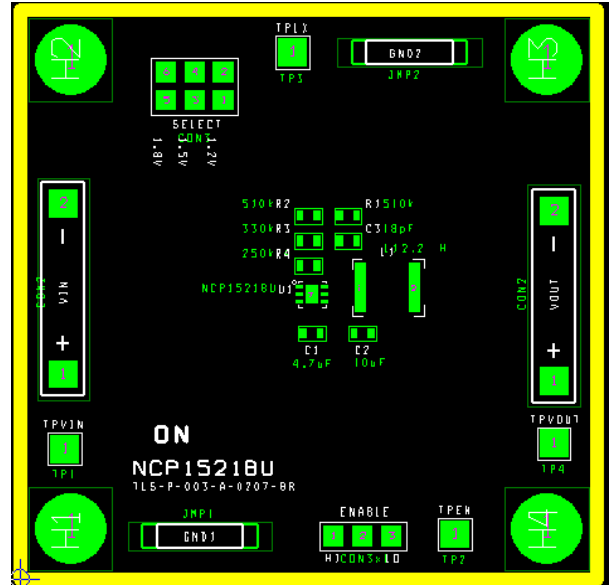

Figure 6. Assembly Layer in μ DFN-6

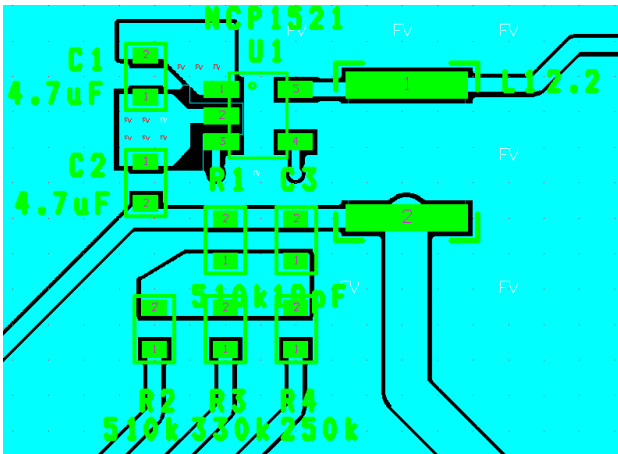

Figure 7. Part Layout in TSOP-5

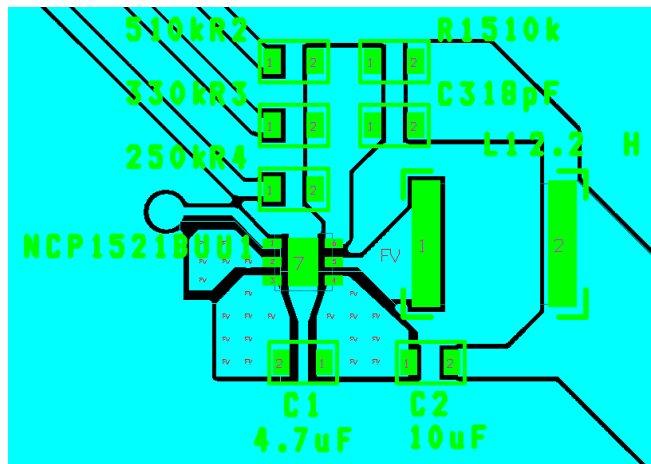

Figure 8. Part Layout in μ DFN-6

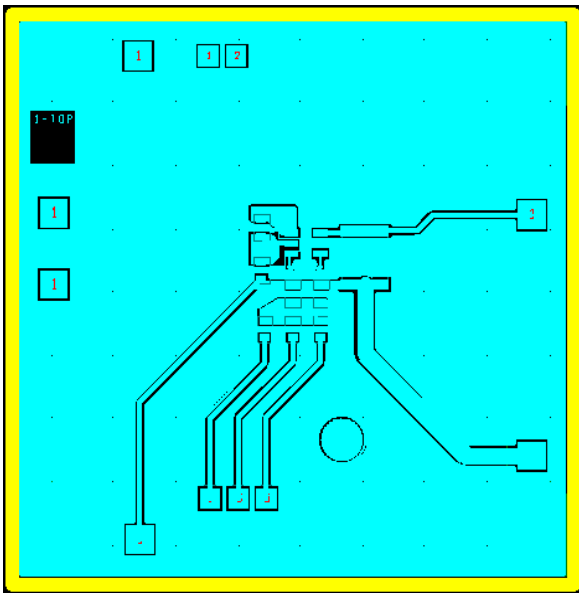

Figure 9. Top Layer Routing in TSOP-5

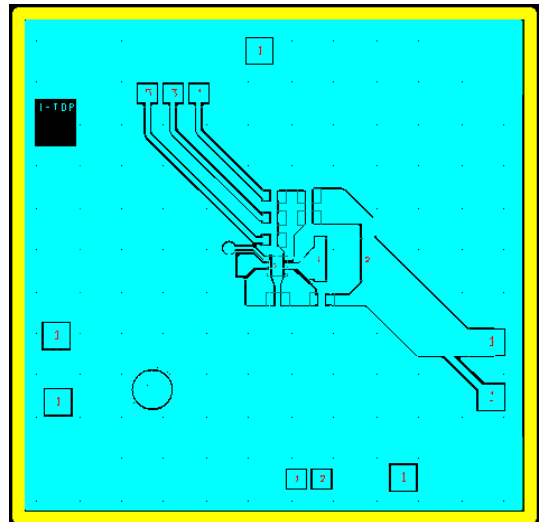

Figure 10. Top Layer Routing in μDFN-6

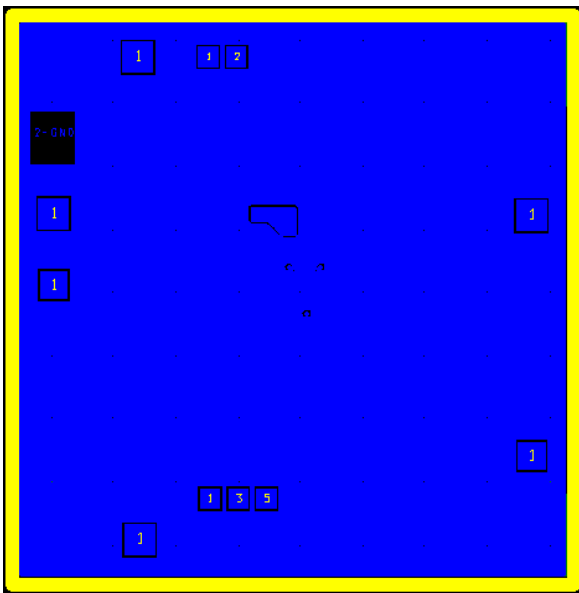

Figure 11. Ground Layer Routing in TSOP-5

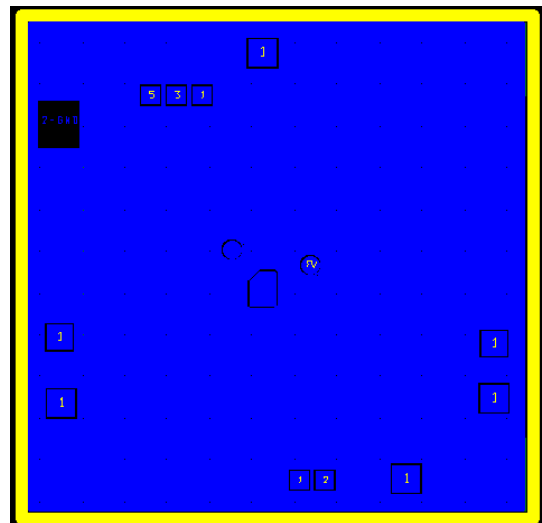

Figure 12. Ground Layer Routing in μDFN-6

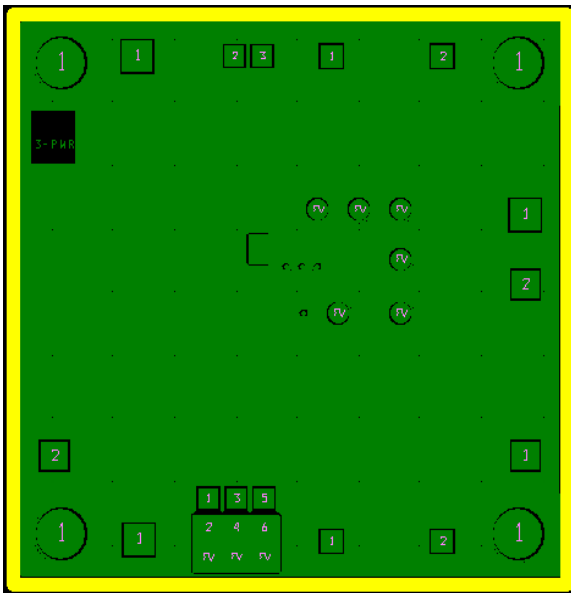

Figure 13. Power Layer Routing in TSOP-5

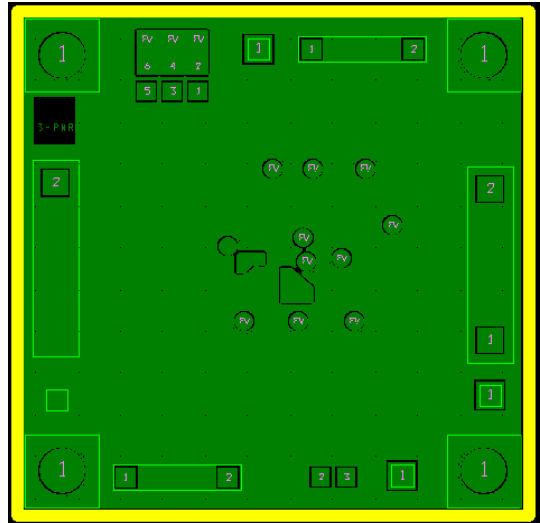

Figure 14. Power Layer Routing in μ DFN-6

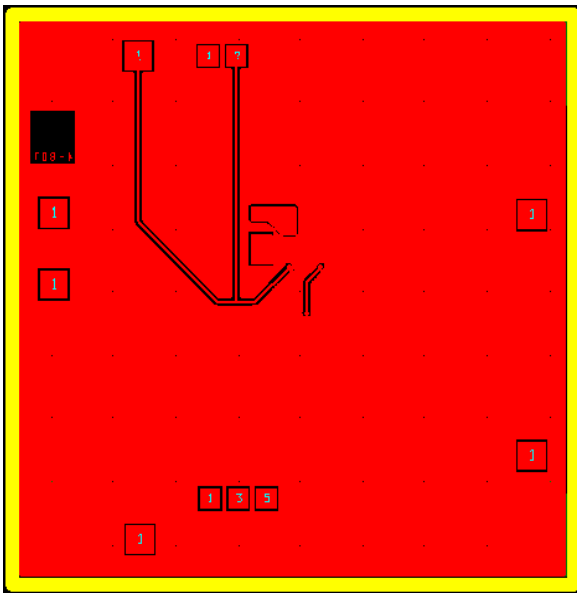

Figure 15. Bottom Layer Routing in TSOP-5

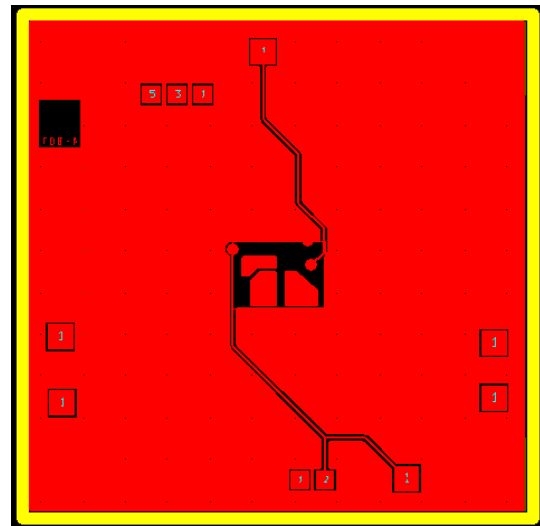

Figure 16. Bottom Layer Routing in μ DFN-6

onsemi, **Onsemi**, and other names, marks, and brands are registered and/or common law trademarks of Semiconductor Components Industries, LLC dba "**onsemi**" or its affiliates and/or subsidiaries in the United States and/or other countries. **onsemi** owns the rights to a number of patents, trademarks, copyrights, trade secrets, and other intellectual property. A listing of **onsemi**'s product/patent coverage may be accessed at www.onsemi.com/site/pdf/Patent-Marking.pdf. **onsemi** is an Equal Opportunity/Affirmative Action Employer. This literature is subject to all applicable copyright laws and is not for resale in any manner.

The evaluation board/kit (research and development board/kit) (hereinafter the "board") is not a finished product and is not available for sale to consumers. The board is only intended for research, development, demonstration and evaluation purposes and will only be used in laboratory/development areas by persons with an engineering/technical training and familiar with the risks associated with handling electrical/mechanical components, systems and subsystems. This person assumes full responsibility/liability for proper and safe handling. Any other use, resale or redistribution for any other purpose is strictly prohibited.

THE BOARD IS PROVIDED BY ONSEMI TO YOU "AS IS" AND WITHOUT ANY REPRESENTATIONS OR WARRANTIES WHATSOEVER. WITHOUT LIMITING THE FOREGOING, ONSEMI (AND ITS LICENSORS/SUPPLIERS) HEREBY DISCLAIMS ANY AND ALL REPRESENTATIONS AND WARRANTIES IN RELATION TO THE BOARD, ANY MODIFICATIONS, OR THIS AGREEMENT, WHETHER EXPRESS, IMPLIED, STATUTORY OR OTHERWISE, INCLUDING WITHOUT LIMITATION ANY AND ALL REPRESENTATIONS AND WARRANTIES OF MERCHANTABILITY, FITNESS FOR A PARTICULAR PURPOSE, TITLE, NON-INFRINGEMENT, AND THOSE ARISING FROM A COURSE OF DEALING, TRADE USAGE, TRADE CUSTOM OR TRADE PRACTICE.

onsemi reserves the right to make changes without further notice to any board.

You are responsible for determining whether the board will be suitable for your intended use or application or will achieve your intended results. Prior to using or distributing any systems that have been evaluated, designed or tested using the board, you agree to test and validate your design to confirm the functionality for your application. Any technical, applications or design information or advice, quality characterization, reliability data or other services provided by **onsemi** shall not constitute any representation or warranty by **onsemi**, and no additional obligations or liabilities shall arise from **onsemi** having provided such information or services.

onsemi products including the boards are not designed, intended, or authorized for use in life support systems, or any FDA Class 3 medical devices or medical devices with a similar or equivalent classification in a foreign jurisdiction, or any devices intended for implantation in the human body. You agree to indemnify, defend and hold harmless **onsemi**, its directors, officers, employees, representatives, agents, subsidiaries, affiliates, distributors, and assigns, against any and all liabilities, losses, costs, damages, judgments, and expenses, arising out of any claim, demand, investigation, lawsuit, regulatory action or cause of action arising out of or associated with any unauthorized use, even if such claim alleges that **onsemi** was negligent regarding the design or manufacture of any products and/or the board.

This evaluation board/kit does not fall within the scope of the European Union directives regarding electromagnetic compatibility, restricted substances (RoHS), recycling (WEEE), FCC, CE or UL, and may not meet the technical requirements of these or other related directives.

FCC WARNING – This evaluation board/kit is intended for use for engineering development, demonstration, or evaluation purposes only and is not considered by **onsemi** to be a finished end product fit for general consumer use. It may generate, use, or radiate radio frequency energy and has not been tested for compliance with the limits of computing devices pursuant to part 15 of FCC rules, which are designed to provide reasonable protection against radio frequency interference. Operation of this equipment may cause interference with radio communications, in which case the user shall be responsible, at its expense, to take whatever measures may be required to correct this interference.

onsemi does not convey any license under its patent rights nor the rights of others.

LIMITATIONS OF LIABILITY: **onsemi** shall not be liable for any special, consequential, incidental, indirect or punitive damages, including, but not limited to the costs of requalification, delay, loss of profits or goodwill, arising out of or in connection with the board, even if **onsemi** is advised of the possibility of such damages. In no event shall **onsemi**'s aggregate liability from any obligation arising out of or in connection with the board, under any theory of liability, exceed the purchase price paid for the board, if any.

The board is provided to you subject to the license and other terms per **onsemi**'s standard terms and conditions of sale. For more information and documentation, please visit www.onsemi.com.

PUBLICATION ORDERING INFORMATION

LITERATURE FULFILLMENT:

Email Requests to: orderlit@onsemi.com

onsemi Website: www.onsemi.com

TECHNICAL SUPPORT

North American Technical Support:

Voice Mail: 1 800-282-9855 Toll Free USA/Canada

Phone: 011 421 33 790 2910

Europe, Middle East and Africa Technical Support:

Phone: 00421 33 790 2910

For additional information, please contact your local Sales Representative

X-ON Electronics

Largest Supplier of Electrical and Electronic Components

Click to view similar products for [Power Management IC Development Tools](#) *category:*

Click to view products by [ON Semiconductor](#) *manufacturer:*

Other Similar products are found below :

[EVAL-ADM1168LQEBZ](#) [EVB-EP5348UI](#) [MIC23451-AAAYFL EV](#) [MIC5281YMME EV](#) [DA9063-EVAL](#) [ADP122-3.3-EVALZ](#) [ADP130-0.8-EVALZ](#) [ADP130-1.2-EVALZ](#) [ADP130-1.5-EVALZ](#) [ADP130-1.8-EVALZ](#) [ADP1712-3.3-EVALZ](#) [ADP1714-3.3-EVALZ](#) [ADP1715-3.3-EVALZ](#) [ADP1716-2.5-EVALZ](#) [ADP1740-1.5-EVALZ](#) [ADP1752-1.5-EVALZ](#) [ADP1828LC-EVALZ](#) [ADP1870-0.3-EVALZ](#) [ADP1871-0.6-EVALZ](#) [ADP1873-0.6-EVALZ](#) [ADP1874-0.3-EVALZ](#) [ADP1882-1.0-EVALZ](#) [ADP199CB-EVALZ](#) [ADP2102-1.25-EVALZ](#) [ADP2102-1.875EVALZ](#) [ADP2102-1.8-EVALZ](#) [ADP2102-2-EVALZ](#) [ADP2102-3-EVALZ](#) [ADP2102-4-EVALZ](#) [ADP2106-1.8-EVALZ](#) [ADP2147CB-110EVALZ](#) [AS3606-DB](#) [BQ24010EVM](#) [BQ24075TEVM](#) [BQ24155EVM](#) [BQ24157EVM-697](#) [BQ24160EVM-742](#) [BQ24296MEVM-655](#) [BQ25010EVM](#) [BQ3055EVM](#) [NCV891330PD50GEVB](#) [ISLUSBI2CKIT1Z](#) [LM2744EVAL](#) [LM2854EVAL](#) [LM3658SD-AEV/NOPB](#) [LM3658SDEV/NOPB](#) [LM3691TL-1.8EV/NOPB](#) [LM4510SDEV/NOPB](#) [LM5033SD-EVAL](#) [LP38512TS-1.8EV](#)