

NCP3334A

Ultra High Accuracy, Low Iq, 500 mA Low Dropout Regulator

The NCP3334A is a high performance, low dropout regulator with accuracy of $\pm 0.9\%$ over line and load. This device features ultra-low quiescent current and noise which encompasses all necessary characteristics demanded by today's consumer electronics. This unique device is guaranteed to be stable without a minimum load current requirement and stable with any type of capacitor as small as 1.0 μF . The NCP3334A offers reverse bias protection. The device is available in a small 3x3 mm WDFN8 package.

Features

- High Accuracy Over Line and Load ($\pm 0.9\%$ at 25°C)
- Ultra-Low Dropout Voltage at Full Load
- No Minimum Output Current Required for Stability
- Low Noise
- Low Shutdown Current
- Reverse Bias Protected
- 2.6 V to 12 V Supply Range
- Thermal Shutdown Protection
- Current Limitation
- Requires Only 1.0 μF Output Capacitance for Stability
- Stable with Any Type of Capacitor (including MLCC)
- These are Pb-Free Devices

Applications

- Telecom Applications
- Cellular Base Stations
- Camcoders and Cameras
- Networking Systems, DSL/Cable Modems
- Cable Set-Top Box
- MP3/CD Players
- DSP Supply
- Displays and Monitors



ON Semiconductor®

www.onsemi.com



WDFN8
MT SUFFIX
CASE 511CF

MARKING DIAGRAM

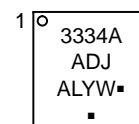

3334A = Specific Device Code
A = Assembly Location
L = Wafer Lot
Y = Year
W = Work Week
▪ = Pb-Free Package

(Note: Microdot may be in either location)

PIN CONNECTIONS

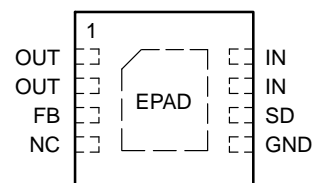

(Top View)

ORDERING INFORMATION

See detailed ordering, marking and shipping information in the package dimensions section on page 7 of this data sheet.

NCP3334A

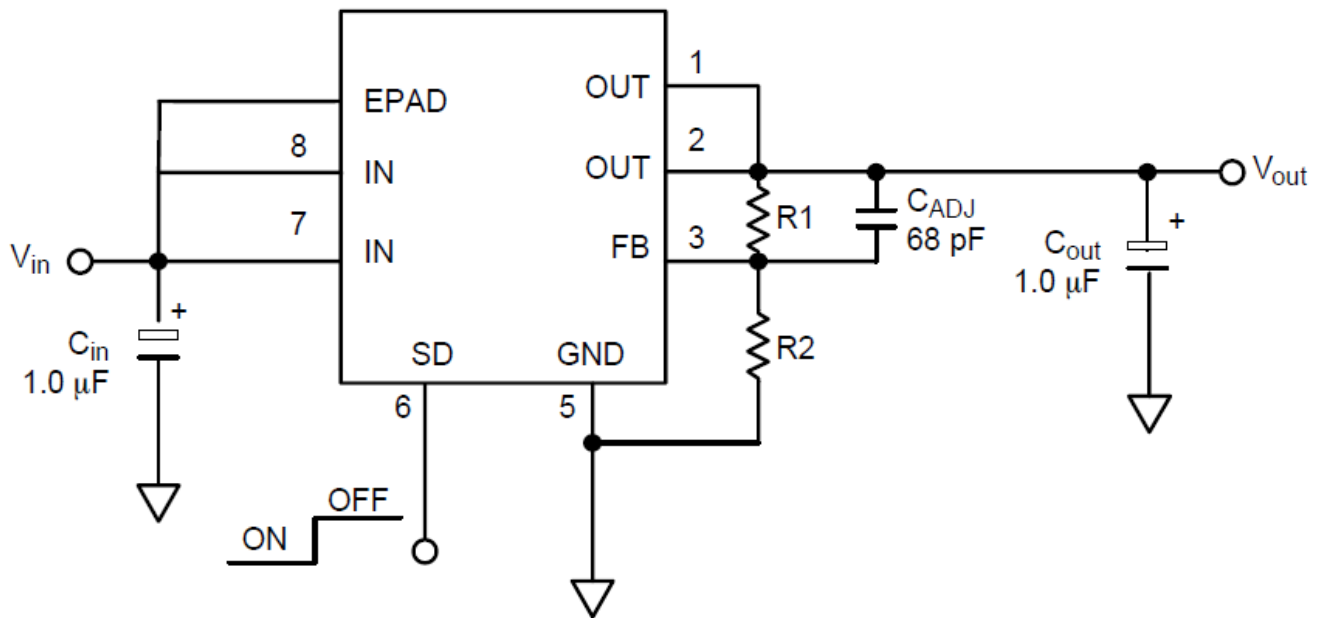

Figure 1. Typical Adjustable Version Application Schematic

NCP3334A

PIN FUNCTION DESCRIPTION

Pin No.	Pin Name	Description
1, 2	V _{out}	Regulated output voltage. Bypass to ground with C _{out} ≥ 1.0 μF.
3	FB	Adjustable pin; reference voltage = 1.178 V.
4	NC	Not Connected
5	GND	Power Supply Ground
6	SD	Shutdown pin. Pulling this pin Low turns on the regulator
7, 8	V _{in}	Power Supply Input Voltage
–	EPAD	Exposed thermal pad should be connected to ground or V _{in} . The EPAD is electrically isolated from the die.

MAXIMUM RATINGS

Rating	Symbol	Value	Unit
Input Voltage	V _{in}	–0.3 to +16	V
Output Voltage	V _{out}	–0.3 to V _{in} +0.3 or 10 V*	V
Shutdown Pin Voltage	V _{sh}	–0.3 to +16	V
Junction Temperature Range	T _J	–40 to +150	°C
Storage Temperature Range	T _{stg}	–65 to +150	°C

Stresses exceeding those listed in the Maximum Ratings table may damage the device. If any of these limits are exceeded, device functionality should not be assumed, damage may occur and reliability may be affected.

NOTE: This device series contains ESD protection and exceeds the following tests:

Human Body Model (HBM) JESD 22–A114–B

*Which ever is less. Reverse bias protection feature valid only if V_{out} – V_{in} ≤ 7 V.

THERMAL CHARACTERISTICS

Characteristic	Test Conditions (Typical Value)		Unit
	Min Pad Board	1" Pad Board (Note 1)	

WDFN 8

Junction-to-Air, θ _{JA}	220	48	°C/W
----------------------------------	-----	----	------

1. As mounted on 4-Layer FR4 Substrate of a specified copper area of 2 oz copper traces in accordance with JEDEC 51.7.

NCP3334A

ELECTRICAL CHARACTERISTICS – Adjustable

($V_{out} = 1.178$ V typical, $V_{in} = 6.0$ V, $T_A = -40^\circ\text{C}$ to $+85^\circ\text{C}$, $C_{in} = C_{out} = 1$ μF , unless otherwise noted, Note 2, 3, 4)

Characteristic	Symbol	Min	Typ	Max	Unit
Reference Voltage Accuracy $V_{in} = V_{outnom} + 0.4$ V to 11 V, $I_{load} = 0.1$ mA to 500 mA, $T_J = 25^\circ\text{C}$	V_{ref}	-0.9% 1.167	1.178	+0.9% 1.189	V
Reference Voltage Accuracy $V_{in} = V_{outnom} + 0.4$ V to 11 V, $I_{load} = 0.1$ mA to 500 mA, $T_J = 85^\circ\text{C}$	V_{ref}	-1.4% 1.162	1.178	+1.4% 1.194	V
Reference Voltage Accuracy (Note 5) $V_{in} = V_{outnom} + 0.4$ V to 11 V, $I_{load} = 0.1$ mA to 500 mA, $T_J = 150^\circ\text{C}$	V_{ref}	-1.5% 1.160	1.178	+1.5% 1.196	V
Line Regulation $V_{in} = (V_{outnom} + 0.4$ V) to 11 V, $I_{load} = 0.1$ mA, $T_J = 25^\circ\text{C}$	LineReg		0.04		mV/V
Load Regulation $I_{load} = 0.1$ mA to 500 mA, $T_J = 25^\circ\text{C}$	LoadReg		0.04		mV/mA
Dropout Voltage, $V_{out} = 98\%$ of V_{outnom} $I_{load} = 500$ mA $I_{load} = 300$ mA $I_{load} = 100$ mA $I_{load} = 1$ mA	V_{DO}		- - - 10	340 230 140 -	mV
Peak Output Current ($V_{in} = V_{outnom} + 1.0$ V)	IpK	500	700	860	mA
Thermal Shutdown	T_J		160		$^\circ\text{C}$
Ground Current In Regulation $I_{load} = 500$ mA (Note 3) $I_{load} = 300$ mA (Note 3) $I_{load} = 50$ mA $I_{load} = 0.1$ mA In Dropout $V_{in} = V_{out} - 0.1$ V, $I_{load} = 0.1$ mA In Shutdown $V_{SD} = 6.0$ V, $V_{in} = 11$ V	I_{GND} I_{GNDsh}		6.0 3.5 0.7 130 -	10 6 1.5 180 450	mA μA
Output Noise $I_{load} = 500$ mA, $f = 10$ Hz to 100 kHz, $C_{out} = 10$ μF , $C_{nr} = 10$ nF $I_{load} = 500$ mA, $f = 10$ Hz to 100 kHz, $C_{out} = 10$ μF , $C_{nr} = 0$ nF	V_{noise}		26 38		μVrms
Shutdown Threshold Voltage OFF Threshold Voltage ON	V_{THSD}	2.0		0.4	V V
SD Input Current, $V_{SD} = 0$ V to 0.4 V or $V_{SD} = 2.0$ V to V_{in}	I_{SD}		1.2	3.0	μA
Output Current In Shutdown Mode, $V_{SD} = 2.0$ V, $V_{in} = 11$ V	I_{OSD}		0.07	1.0	μA
Reverse Bias Protection, Current Flowing from the Output Pin to GND ($V_{in} = 0$ V, $V_{out_forced} = V_{out(nom)} \leq 7$ V) (Note 6)	I_{OUTR}		1.0		μA

Product parametric performance is indicated in the Electrical Characteristics for the listed test conditions, unless otherwise noted. Product performance may not be indicated by the Electrical Characteristics if operated under different conditions.

- All limits at temperature extremes are guaranteed via correlation using standard statistical quality control (SQC) methods.
- Ambient temperature of 85°C corresponds to a junction temperature of 125°C under pulsed full load test conditions.
- Application stable with no load.
- $V_{IN} = 2.6$ V to 11 V for $V_{OUT(NOM)} \leq 2.2$ V and $T_J > 0^\circ\text{C}$, otherwise $V_{IN} = 2.9$ V to 11 V.
- Reverse bias protection feature valid only if $V_{out} - V_{in} \leq 7$ V.

TYPICAL CHARACTERISTICS

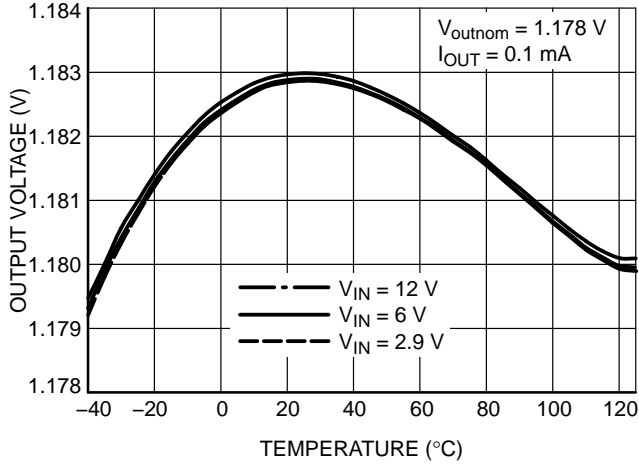

Figure 2. Output Voltage vs. Temperature

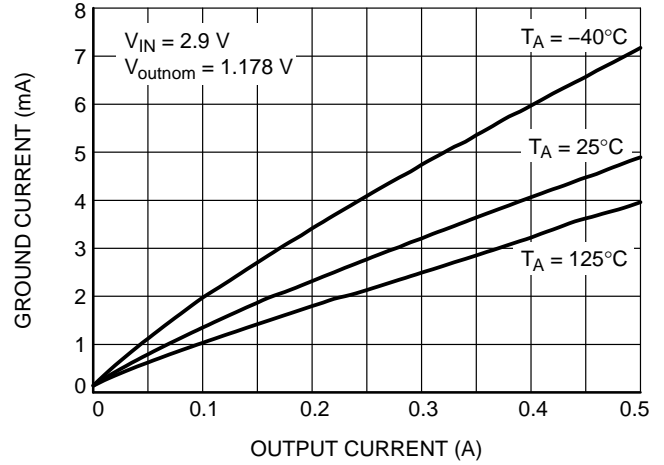

Figure 3. Ground Current vs. Output Current

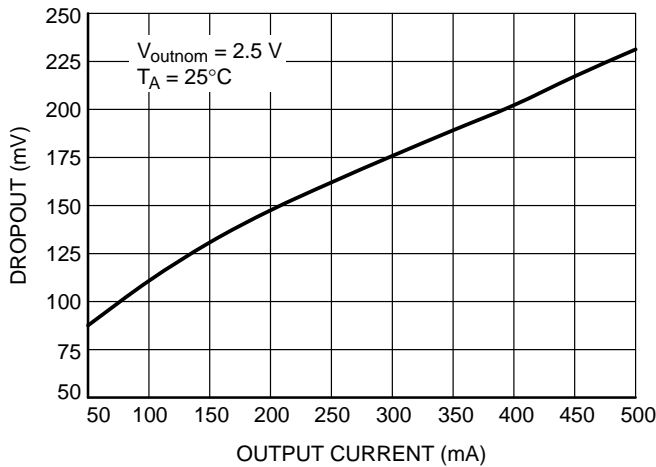

Figure 4. Dropout Voltage vs. Output Current

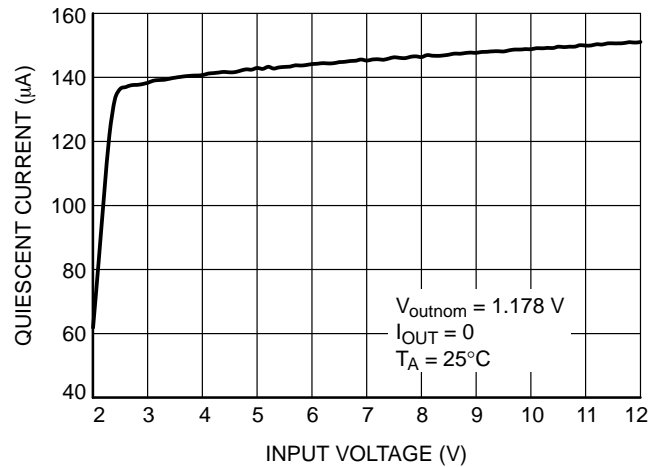

Figure 5. Quiescent Current vs. Input Voltage

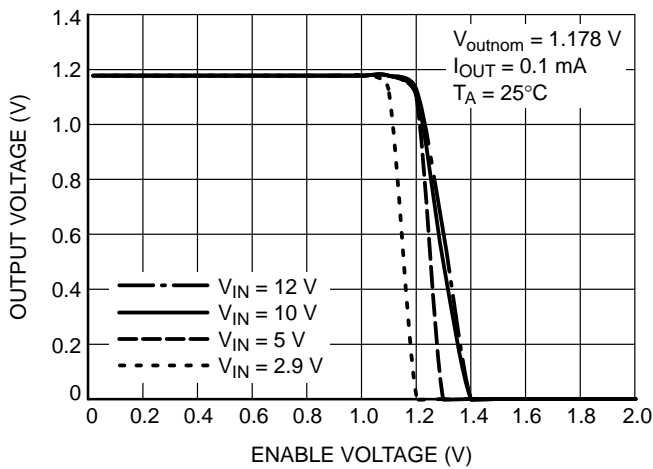

Figure 6. Enable OFF Threshold

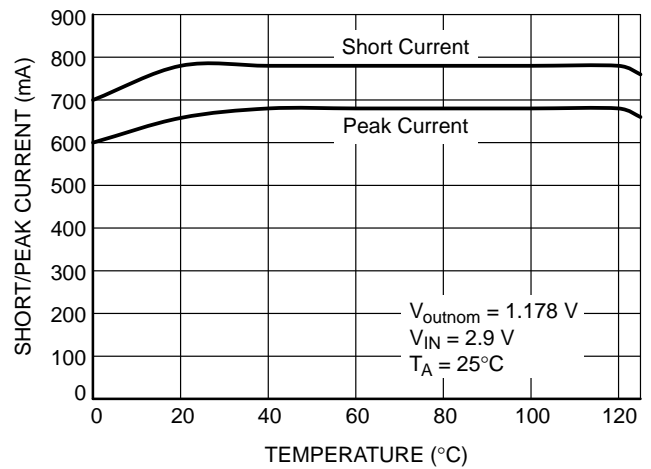

Figure 7. Peak and Short Current vs. Temperature

NCP3334A

TYPICAL CHARACTERISTICS

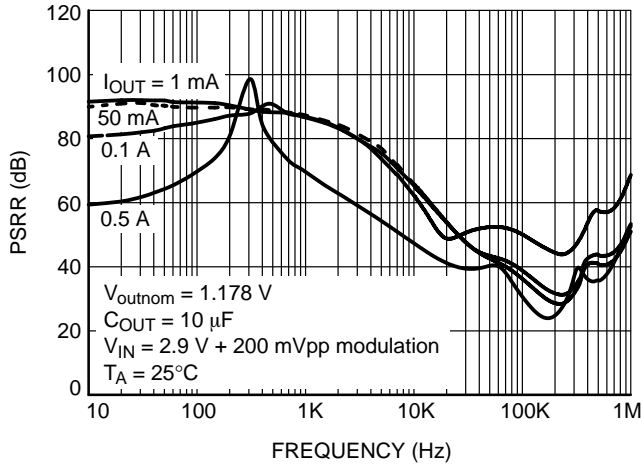

Figure 8. PSRR vs. Frequency

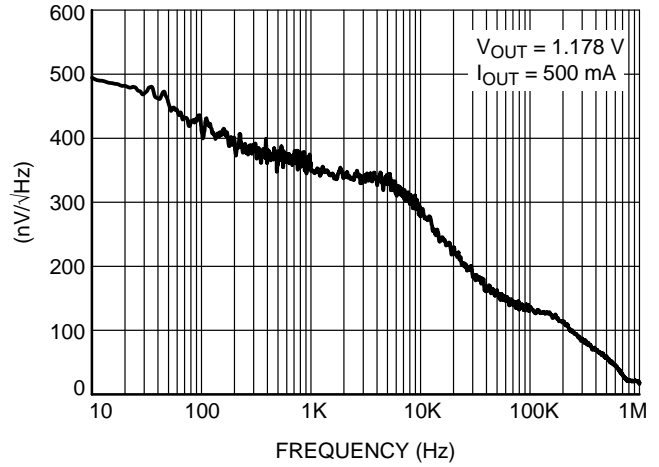

Figure 9. Output Noise Density

NCP3334A

APPLICATIONS INFORMATION

Reverse Bias Protection

Reverse bias is a condition caused when the input voltage goes to zero, but the output voltage is kept high either by a large output capacitor or another source in the application which feeds the output pin.

Normally in a bipolar LDO all the current will flow from the output pin to input pin through the PN junction with limited current capability and with the potential to destroy the IC.

Due to an improved architecture, the NCP3334A can withstand up to 7.0 V on the output pin with virtually no current flowing from output pin to input pin, and only negligible amount of current (tens of μA) flowing from the output pin to ground for infinite duration.

Input Capacitor

An input capacitor of at least 1.0 μF , any type, is recommended to improve the transient response of the regulator and/or if the regulator is located more than a few inches from the power source. It will also reduce the circuit's sensitivity to the input line impedance at high frequencies. The capacitor should be mounted with the shortest possible track length directly across the regular's input terminals.

Output Capacitor

The NCP3334A remains stable with any type of capacitor as long as it fulfills its 1.0 μF requirement. There are no constraints on the minimum ESR and it will remain stable up to an ESR of 5.0 Ω . Larger capacitor values will improve the noise rejection and load transient response.

Adjustable Operation

The output voltage can be set by using a resistor divider with a range of 1.178 to 10 V. The appropriate resistor divider can be found by solving the equation below. The recommended current through the resistor divider is from 10 μA to 100 μA . This can be accomplished by selecting resistors in the $\text{k}\Omega$ range. As result, the $I_{\text{adj}} \cdot R_2$ becomes negligible in the equation and can be ignored.

$$V_{\text{out}} = 1.178 \cdot \left(1 + \frac{R_1}{R_2}\right) + I_{\text{adj}} \cdot R_2 \quad (\text{eq. 1})$$

Dropout Voltage

The voltage dropout is measured at 97% of the nominal output voltage.

Thermal Considerations

Internal thermal limiting circuitry is provided to protect the integrated circuit in the event that the maximum junction temperature is exceeded. This feature provides protection from a catastrophic device failure due to accidental overheating. This protection feature is not intended to be used as a substitute to heat sinking. The maximum power that can be dissipated, can be calculated with the equation below:

$$P_D = \frac{T_{J(\text{max})} - T_A}{R_{\theta JA}} \quad (\text{eq. 2})$$

For improved thermal performance, contact the factory for the WDFN package option. The WDFN package includes an exposed metal pad that is specifically designed to reduce the junction to air thermal resistance, $R_{\theta JA}$.

ORDERING INFORMATION

Device	Nominal Output Voltage	Marking	Package	Shipping†
NCP3334AMTADJTBG	Adj.	3334A ADJ	WDFN8 (Pb-Free)	3000 / Tape & Reel

†For information on tape and reel specifications, including part orientation and tape sizes, please refer to our Tape and Reel Packaging Specifications Brochure, BRD8011/D.

*Please contact factory for other voltage options.

NCP3334A

PACKAGE DIMENSIONS

WDFN8 3x3, 0.5P
CASE 511CF
ISSUE O

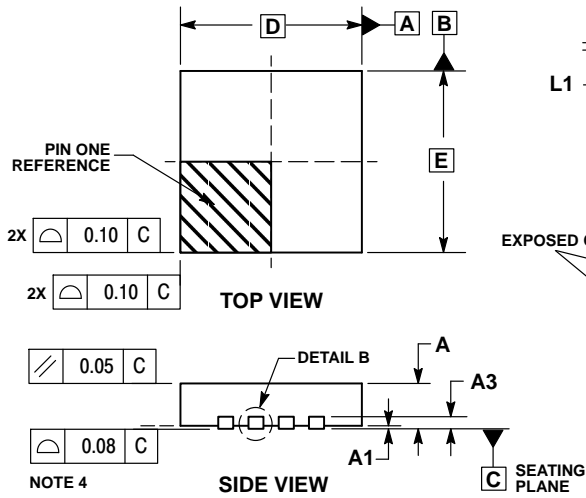

NOTES:

1. DIMENSIONING AND TOLERANCING PER ASME Y14.5M, 1994.
2. CONTROLLING DIMENSION: MILLIMETERS.
3. DIMENSION b APPLIES TO PLATED TERMINAL AND IS MEASURED BETWEEN 0.05 AND 0.15 MM FROM TERMINAL TIP.
4. COPLANARITY APPLIES TO THE EXPOSED PAD AS WELL AS THE TERMINALS.
5. POSITIONAL TOLERANCE APPLIES TO ALL OF THE EXPOSED PADS.

DIM	MILLIMETERS	
	MIN	MAX
A	0.70	0.80
A1	0.00	0.05
A3	0.20	REF
b	0.20	0.30
D	3.00	BSC
D2	1.65	1.85
E	3.00	BSC
E2	1.35	1.55
e	0.50	BSC
L	0.30	0.50
L1	0.00	0.15

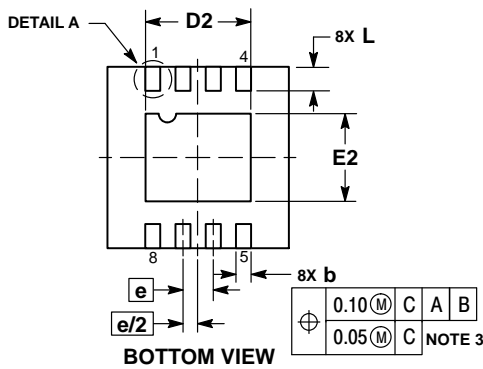

RECOMMENDED SOLDERING FOOTPRINT*

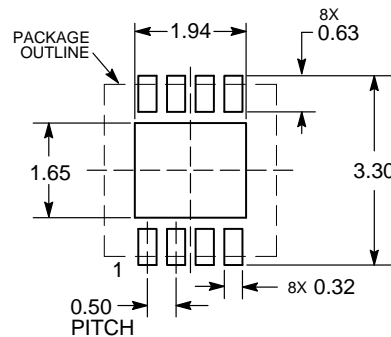

DIMENSIONS: MILLIMETERS

*For additional information on our Pb-Free strategy and soldering details, please download the ON Semiconductor Soldering and Mounting Techniques Reference Manual, SOLDERRM/D.

Micro8 is a trademark of International Rectifier.

ON Semiconductor and the  are registered trademarks of Semiconductor Components Industries, LLC (SCILLC) or its subsidiaries in the United States and/or other countries. SCILLC owns the rights to a number of patents, trademarks, copyrights, trade secrets, and other intellectual property. A listing of SCILLC's product/patent coverage may be accessed at www.onsemi.com/site/pdf/Patent-Marketing.pdf. SCILLC reserves the right to make changes without further notice to any products herein. SCILLC makes no warranty, representation or guarantee regarding the suitability of its products for any particular purpose, nor does SCILLC assume any liability arising out of the application or use of any product or circuit, and specifically disclaims any and all liability, including without limitation special, consequential or incidental damages. "Typical" parameters which may be provided in SCILLC data sheets and/or specifications can and do vary in different applications and actual performance may vary over time. All operating parameters, including "Typicals" must be validated for each customer application by customer's technical experts. SCILLC does not convey any license under its patent rights nor the rights of others. SCILLC products are not designed, intended, or authorized for use as components in systems intended for surgical implant into the body, or other applications intended to support or sustain life, or for any other application in which the failure of the SCILLC product could create a situation where personal injury or death may occur. Should Buyer purchase or use SCILLC products for any such unintended or unauthorized application, Buyer shall indemnify and hold SCILLC and its officers, employees, subsidiaries, affiliates, and distributors harmless against all claims, costs, damages, and expenses, and reasonable attorney fees arising out of, directly or indirectly, any claim of personal injury or death associated with such unintended or unauthorized use, even if such claim alleges that SCILLC was negligent regarding the design or manufacture of the part. SCILLC is an Equal Opportunity/Affirmative Action Employer. This literature is subject to all applicable copyright laws and is not for resale in any manner.

PUBLICATION ORDERING INFORMATION

LITERATURE FULFILLMENT:
Literature Distribution Center for ON Semiconductor
P.O. Box 5163, Denver, Colorado 80217 USA
Phone: 303-675-2175 or 800-344-3860 Toll Free USA/Canada
Fax: 303-675-2176 or 800-344-3867 Toll Free USA/Canada
Email: orderlit@onsemi.com

N. American Technical Support: 800-282-9855 Toll Free
USA/Canada
Europe, Middle East and Africa Technical Support:
Phone: 421 33 790 2910
Japan Customer Focus Center
Phone: 81-3-5817-1050

ON Semiconductor Website: www.onsemi.com
Order Literature: <http://www.onsemi.com/orderlit>

For additional information, please contact your local Sales Representative

X-ON Electronics

Largest Supplier of Electrical and Electronic Components

Click to view similar products for [LDO Voltage Regulators](#) category:

Click to view products by [ON Semiconductor](#) manufacturer:

Other Similar products are found below :

[AP7363-SP-13](#) [NCV8664CST33T3G](#) [L79M05TL-E](#) [AP7362-HA-7](#) [PT7M8202B12TA5EX](#) [TCR3DF185,LM\(CT](#) [TLF4949EJ](#)
[NCP4687DH15T1G](#) [NCV8703MX30TCG](#) [LP2951CN](#) [NCV4269CPD50R2G](#) [AP7315-25W5-7](#) [NCV47411PAAJR2G](#) [AP2111H-1.2TRG1](#)
[ZLDO1117QK50TC](#) [AZ1117ID-ADJTRG1](#) [NCV4263-2CPD50R2G](#) [NCP706ABMX300TAG](#) [NCP114BMX075TCG](#) [MC33269T-3.5G](#)
[TLE4471GXT](#) [AP7315-33SA-7](#) [NCV4266-2CST33T3G](#) [NCP715SQ15T2G](#) [NCV8623MN-50R2G](#) [NCV563SQ18T1G](#) [NCV8664CDT33RKG](#)
[NCV4299CD250R2G](#) [NCP715MX30TBG](#) [NCV8702MX25TCG](#) [TLE7270-2E](#) [NCV562SQ25T1G](#) [AP2213D-3.3TRG1](#) [AP2202K-2.6TRE1](#)
[NCV8170BMX300TCG](#) [NCV8152MX300180TCG](#) [NCP700CMT45TBG](#) [AP7315-33W5-7](#) [NCP154MX180300TAG](#) [AP2113AMTR-G1](#)
[NJW4104U2-33A-TE1](#) [MP2013AGG-5-P](#) [NCV8775CDT50RKG](#) [NJM2878F3-45-TE1](#) [S-19214B00A-V5T2U7](#) [S-19214B50A-V5T2U7](#) [S-](#)
[19213B50A-V5T2U7](#) [S-19214BC0A-E8T1U7*1](#) [S-19213B00A-V5T2U7](#) [S-19213B33A-V5T2U7](#)